

Kountry Style

A publication of Newmar Corporation

Volume 1

September 1984

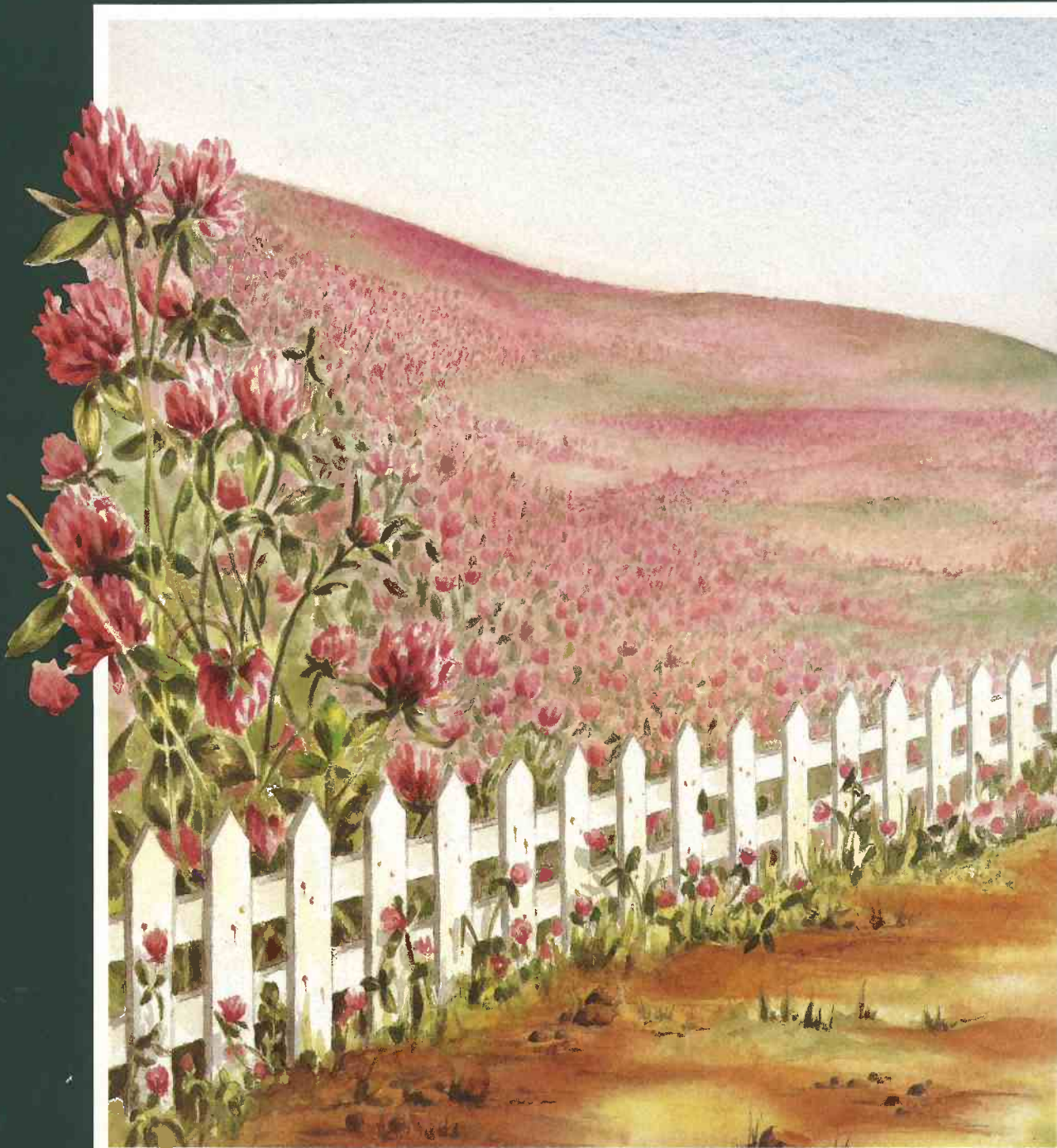

*This magazine has been published
in celebration of the American way of life,
fine art and craftsmanship.*

To our readers:

In presenting the 1985 product line of Newmar Corporation, it has been the intention of this publisher to also bring to our readers a magazine depicting American talent, integrity and pride.

On the following pages, we have combined the fine art of watercolor, exacting still photography, and a distinctly American literary style — all to better focus on the single most important art form displayed here: the Newmar Corporation recreational vehicles.

It is our sincere wish that you, the reader, enjoy this publication as much as we have enjoyed preparing it for you.

CONTENTS

Volume 1, September 1984

Kountry Style

Kountry Lite

Towables 2

Kountry Aire

Towables 6

Motorized 10

London Aire

Towables 14

Motorized 18

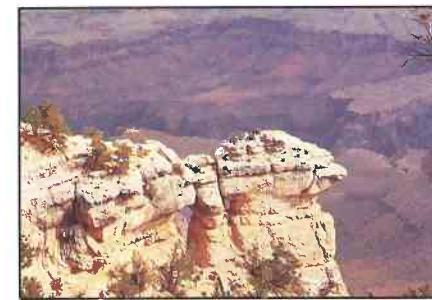

The Grand Canyon — where Mother Nature gives a spectacular performance daily! This is but one of the "natural art forms" you'll see as you travel America with us.

Special Features 22

Construction 23

Be Our Guest! 24

Kountry Style is published annually by Newmar Corporation. Editorial and executive offices are located in Nappanee, Indiana 46550.

Copyright © 1984 Newmar Corporation. All rights reserved. Copyright contents may not be reproduced in any manner without prior written permission of Kountry Style.

Kountry Style

Established 1984

Editor-in-Chief: Mahlon Miller

Associate Editor: Krisanne Anglin

Advertising Director: Donald Rink

Watercolorist: Betty Brant

Photographer: Gary Mills

Stylist: Bonnie Hoffer

Publishers: Hendershot & Associates

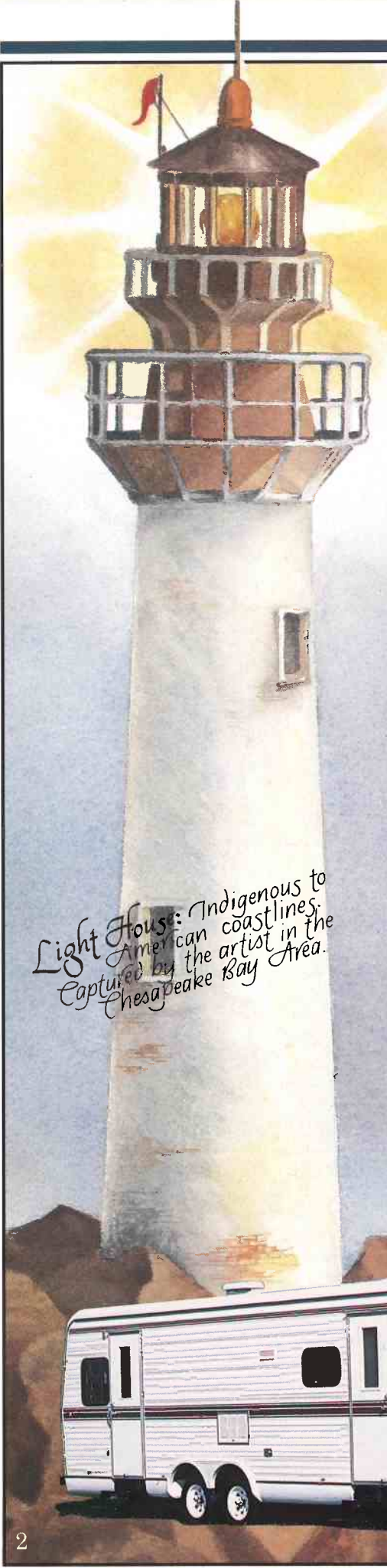

Light House: Indigenous to American coastlines, captured by the artist in the Chesapeake Bay Area.



All the comforts of home — in your Kountry Lite "land yacht."

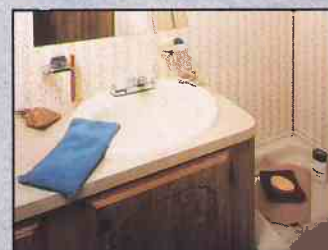

After a long day on the road, you can treat yourself to a bubble bath!

Kountry Lite

The first of the three Newmar Corporation lines presented here is the Kountry Lite line. This line consists of two towable units: the Kountry Lite Travel Trailer and the Kountry Lite Fifth Wheel. Both are fine examples of expert workmanship at affordable prices.



Cook up something special for "stowaways" in the fully-equipped kitchen of the Fifth Wheel.

Lite House

A lighthouse can be different things to different people.

It's a welcome beacon to weary travellers. It's a picturesque point to landlubbers. To some, it's even a home.

Our "lite house" is all these things — and more.

"Lite House" — because its aluminum structure makes this house-on-wheels very lightweight.

Both the Kountry Lite Travel Trailer and Fifth Wheel are "lite houses." And because they're lightweight, they'll lower your fuel consumption when towing. Radius caps and corners and the aerodynamic design also tend to increase your m.p.g.



As you travel this enormous land of ours, be sure you visit our beaches and coastal areas. They're some of the prettiest anywhere!



Lots of room to stow your gear in Kountry Lite's exterior storage compartments.



Decorative wire mesh accents living room cabinet doors in the Kountry Lite line.



Built-in nightstands give extra storage space to the Travel Trailers.



Stretch out in the roomy Fifth Wheel bedroom.



This convenient dinette in the Kountry Lite line not only converts to an extra bed, but has easy-access storage areas underneath.

This lite house shines — inside and out!

All new for Kountry Lite in '85 is the dramatic exterior striping. And the inside has changed just as dramatically! Pecan paneling, padded carpeting, designer-selected fabrics and colors in the living room. Tie-back draperies and valances with textured roller shades. Beautifully routed door lines on the cabinetry, and decorative headboards in the bedroom. So much for your money, you'll wonder how Kountry Lite remains Newmar Corporation's "economical line."

If you've been floundering in a "sea of RV's" — wondering just which one to buy — search no longer!

THE KOUNTRY LITE SWITCH IS ON!

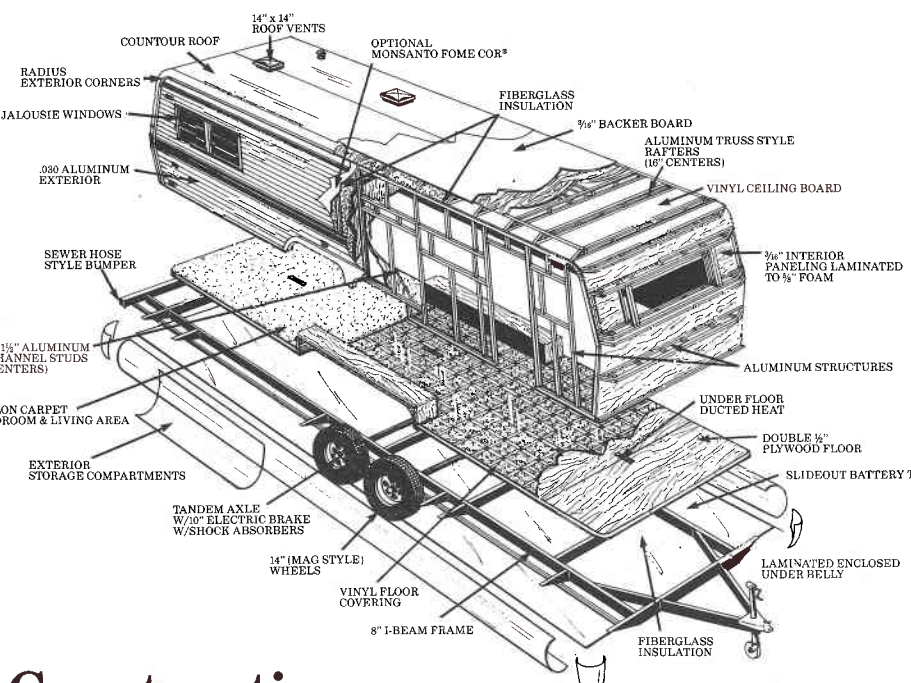

Construction

Standard and Optional Features

S = Standard
O = Optional

A. AIR CONDITIONING, GAS & HEATING

Electronic Ignit. Furnace 25M (20'-24' Units)	1	S
Electronic Ignit. Furnace 32M (25'-30' Units)	2	S
Electronic Ignit. Furnace 35M (31'-35' Units)	3	S
Electronic Ignit. Furnace 41M (36'-40' Units)	4	S
Next Size Larger Furnace in Lieu of Standard	5	O
2-20#Steel LP Gas Bottles w/Manual Regulator	6	S
2-40#Steel LP Gas Bottles w/Automatic Regulator	7	O
2-40#Steel LP Gas Bottles w/Automatic Regulator	8	O
Rosan® LP Leak Detector	9	O
Wire for Air Conditioner (T only)	10	S
Wire for Extra Air Conditioner	11	O
13.5 Coleman® Air Conditioner	12	O
Heat Strip for Air Conditioner	13	O
Under Floor Ducted Heat	14	S

B. APPLIANCES

RV106 Sibir® Refrigerator 2-Way	1	S
RV108 Sibir® Refrigerator 2-Way	2	O
RV110 Sibir® Refrigerator 2-Way	3	O
Domestic® Refrigerator in Lieu of Std. (comp. size)	4	O
Model 763 3-Way AES	5	O
Model 1303 3-Way AES	6	O
Range Hood w/Light & Fan	7	S
18" 4-Burner Range w/Oven, Top Pilot	8	S
Bi-fold Range Cover	9	O
Microwave Oven	10	O
Microwave Prep 16"H x 21 1/2"W x 13 1/2"D	11	O
Double Stainless Steel Sink	12	S
Laminated Sink Cover (1 only)	13	S
Double Handle Mixing Faucet	14	S
6 Gallon Gas Water Heater	15	S
6 Gal. Gas Water Heater w/Elec. Ign. in Lieu of Std.	16	O
10 Gal. Gas/Electric Water Heater in Lieu of Std.	17	O
Large Lavatory Sink	18	S
Tub/Shower Combination	19	S
Full Fiberglass Bathtub and Door	20	O
Portable Vacuum System	21	O
Washer & Dryer Prep (incl. plumbing, elect. recept)	22	O
Washer & Dryer	23	O

C. AWNINGS, DOORS, VENTS & WINDOWS

36" x 42" Picture Window at Dinette	1	S
Square Torque Regular Glass Window (Hehr®)	2	S
22-32" TT & FW Radius Tinted Torque Safety Glass (Must Option in New Jersey) (Hehr®)	3	O
33'-40" TT & FW Radius Tinted Torque Safety Glass (Must Option in New Jersey) (Hehr®)	4	O
36" x 48" Picture Window - Radius Only (each)	5	O
48" x 36" Picture Window - Radius Only (each)	6	O
48" x 48" Picture Window - Radius Only (each)	7	O
48" x 36" Picture Window - Square (each)	8	O
3' x 30" Picture Window - Radius Only (each)	9	O
Power Roof Vent in Bath Area w/Wall Switch	10	S
Non-Power Roof Vent in A/C Location	11	S
Roof Vent	12	O
Power Roof Vent	13	O
26" Entrance Door w/Screen	14	S
Front Travel Awning (Travel Trailers)	15	S
Rear Travel Awning	16	O
Carter® Side Awning	17	O
Center Support for Side Awning	18	O
Front Window & Awning (Fifth Wheels)	19	O
Grab Handle	20	S
Vinyl Folding Door	21	S
Wood Folding Door in Lieu of Vinyl Door	22	O
Extra Vinyl Folding Door	23	O
Dead Bolt Lock (each)	24	O
Door Bell	25	O

D. CABINETS & FURNITURE

Dinette w/Pedestal Table (Except in 27' RB & 31' CB TT; 23' FB, 26' FB, 35' CBWT, 35' WTRF, 35' WTRF, 40' CB, 40' CBWT, 40' WTRF, 40' WTRF FW)	1	S
Twin or Double Bed	2	S
Free Standing Sleeper Sofa (see floor plans)	3	S
Wall Mount Table (27' RB & 31' CB TT; 23' FB, 26' FB, 35' CBWT, 35' WTRF, 35' WTRF, 40' CB, 40' CBWT, 40' WTRF, 40' WTRF FW)	4	S
Cabinet Bunk w/Poly Foam Mattress, 32"	5	O
Stationary Bunk w/Poly Foam Mattress, 32"	6	O
Queen Bed	7	O
Fitted Sheets for Twin, Double & Queen Beds	8	O
Clothes Hamper (CB & FB Models only)	9	S
Medicine Cabinet	10	S
Night Stand (1 for TB; 2 for DBL)	11	S
Decorative Headboards	12	S
Rocker Chair	13	O
Pedestal Chair	14	O

Access Doors under Dinette	15	O
Hi-Lo Table	16	O
Counter Top Extension	17	O
Extra Overhead Cabinet (each)	18	O
Omit Dinette and Install Table Height Bar	19	O
Extra Wardrobe at Door Side w/Angle Lower	20	O
TV Cabinet (RB & CB FW only) (#131)	21	O
Omit Front Door and Install Wardrobe (WT FW only) (#151)	22	O
Wall Mount Table (extra)	23	O
Drop Cabinet Top to Bar Level (32" WTRF)	24	O
Party Package - Omit Door Side Loungette. Add 2 Pedestal Chairs, Small Pedestal Table & a 36" x 48" Bay Window (26' FBTL)	24	O

E. ELECTRICAL & LIGHTING EQUIPMENT

Wire for Stereo	1	S
AM/FM Stereo w/Cassette, Clock & 4 Speakers	2	O
TV Antenna w/2 Jacks	3	O
Hook Up for Cable TV	4	O
Radio Antenna w/4 Speakers	5	O
1 - 110v GFI Recept Interior	6	S
Exterior Recept	7	S
Porch Light w/Inside Switch	8	S
1 - 80 AMP Battery	9	S
1 - 85 AMP Deep Cycle Battery	10	O
40 AMP Converter w/Charger	11	S
30 AMP Service	12	S
50 AMP Service	13	S
Fire Extinguisher 5 BC	14	S
Fire Extinguisher 10 BC	15	O
Smoke Detector	16	S
Monitor Panel	17	O
Battery Clock	18	O
Exterior Security Lights (4)	19	O
Intercom	20	O
Wire for Telephone	21	O

F. INTERIORS

Vinyl Floor Covering	1	S
Carpet w/Pad in Bedroom & Living Room	2	S
Carpet w/Pad (per ft.)	3	O
3/16" Pecan Paneling	4	S
Wainscoting in Living Room	5	S
Wood Grain Paneling in Lieu of Wainscoting	6	O
12" Raised Roof Option (Fifth Wheels)	7	O
Decorative Panels in Bath	8	S
Light Color Paneling in Bedroom	9	S
Textured Roller Shades w/Correlating Tie Back Draperies & Matching Valances	10	S
Kountry Aire Hercules Fabric Package (5-4 & 5-5) (Includes Upholstery, Drapes in Living Area & Carpet)	11	O
Bedspread Queen	12	O
Bedspread Double	13	O
Bedspread Twins	14	O

G. WATER SYSTEMS

Air Accumulator Tank	1	S
Demand Water System	2	S
City Water Hook-Up	3	S
35 Gallon Grey Water Tank	4	S
35 Gallon Sewage Waste Holding Tank	5	S
Fresh Water Tanks:		
Travel Trailers:		
22 RBD 27 Gallon	6	S
25 CBD, 27 RB 31 Gallon	7	S
29 CBD, 31 CB, 31 CBD, 33 CBD, 33 RBD, 35 CBD, 35 RBD 56 Gallon	8	S
Fifth Wheels:		
23 FBD, 23 RBD, 26 FBTL, 26 RBD, 29 RBD	9	S
29 WTD, 29 FBTK 31 Gallon		
35 WTRF, 35 WRFD, 40 WTRF, 40 WRFD 35 Gal.	10	S
32 RBD, 32 WTRF, 32 WTD, 35 FBTK, 35 RBD, 40 FBTK 45 Gallon	11	S
35 CBWT, 35 WTRF, 35 WTD, 40 CB, 40 CBWT, 40 RBD, 40 WTRF, 40 WTD 56 Gallon	12	S

H. EXTERIOR

Exterior Storage Compartments (Doors, no Slide Outs)	1	S
Bumper Cover	2	O
Roof Rack & Split Ladder	3	O
Roof Storage Pod 21 cu. ft.	4	O
Roof Storage Pod 10 cu. ft.	5	O

I. RUNNING GEAR & CONSTRUCTION

Aluminum Structure (16" Centers)	1	S
Frame size 8" I-Beam	2	S
10" Electric Brake	3	S
Shock Absorbers	4	S
14" Wheels	5	S
15" Wheel (each)	6	O
F78 x 14 Load Range C Tires	7	S
8.55 Load Range C - White Walls (each)	8	O
Spare Tire & Wheel	9	O
Spare Tire Carrier	10	O
Spare Tire Cover	11	O
Fiberglass Insulation Sidewalls & Roof	12	S
Fiberglass Insulation in Floor	13	S
Laminated 5/8" Foam Insulation Sidewalls & Roof	14	S
Enclosed Underbelly w/Laminated 5/8" Foam	15	S
Fome-Cor® Insulation Exterior Sidewalls & Roof	16	O
Double Entrance Step	17	S
Double 1/2" Plywood Floor	18	S
Power Hitch Jack (Travel Trailers)	19	O
Power Hitch Jacks (Fifth Wheels)	20	O
48" or 54" Fifth Wheel Hitch Plate & Bracket	21	O
Install Fifth Wheel Hitch	22	O
Stabilizer Jacks (set of 2)	23	O
Wire for Power Jack	24	O
Mor-Hyde® Suspension	25	O

J. MISCELLANEOUS

Customer Pick Up	1	O
------------------	---	---

Decor Packages



Rose Bouquet Honey & Spice Midnight Blue.

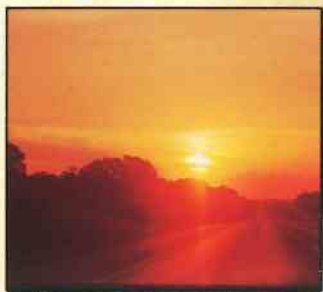

Midwesterners say they'll put their sunsets up against anybody's. Come take a look, and decide!



All-new diagonally accented cabinetry is featured in the 1985 Kountry Aire line. And the appointments you see here are standard.



Here's a close-up of the optional power slide-out that gives extra room to the Kountry Aire Fifth Wheel.

Kountry Aire

Newmar Corporation's mid-line vehicles are anything but middle-of-the-road! If you've had a chance to compare Kountry Aire to the competition, you'll recognize some important differences. If you haven't compared, we urge you to do so!

Sweet Corn: Indigenous to the American Midwest. Captured by the artist in central Iowa.



Executive Suite — this is the ultimate in space and style: the Kountry Aire Fifth Wheel with optional power slide-out.



Color-coordinated soft shades and padded headboard make this Fifth Wheel bedroom extra comfortable.

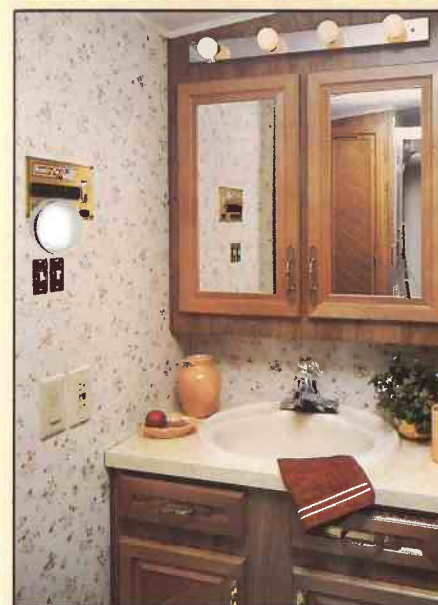

Kountry Kitchen

Traveling — at its very best — involves all the senses: sight, sound, smell, touch and taste! And no matter when you travel, there's always something good cooking all across America.

Take advantage of seasonal foods by taking a complete kitchen — Kountry Aire!

Feast your family on Maine lobster or New England clam chowder, thanks to Kountry Aire's 22", 4-burner range.

Keep Florida citrus or Wisconsin cheese and sausage fresh in the 3-way Dometic refrigerator. Or freeze wild strawberries and huckleberries found in the north woods.

Spend the round-up season in the Southwest learning the secrets of Texas chili and "real" barbeque.

There's plenty of storage space in your Kountry Kitchen, so you can bring home things like Idaho potatoes and Michigan apples.

Clean-up is easy in a Kountry Aire kitchen thanks to the double stainless steel sink and the single handle mixing faucet with spray hose.

Best of all, the rest of the Kountry Aire vehicles are just as complete and comfortable as the kitchens! Take a closer look, and whet your appetite!

TRAVELIN' IN THE KOUNTRY AIRE — NATURALLY!





Roseberry is one of our freshest decor packages, shown here in the Travel Trailer.



Shower or bathe. It's your choice, in the Travel Trailer.



Some cabinets in the Travel Trailer have the decorative etched glass effect.

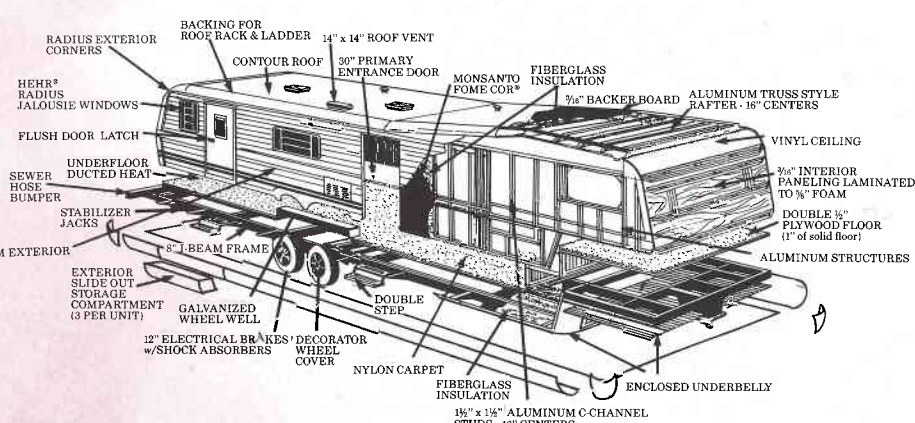

Red Flower: Indigenous to the American Dairy Country. Captured by the artist in northern Wisconsin.

Construction

Standard and Optional Features

S = Standard
O = Optional

Category	Item	Quantity	Type	
A. AIR CONDITIONING, GAS & HEATING	Electronic Ignit. Furnace 25M (20' - 24' Units)	1	S	
	Electronic Ignit. Furnace 32M (25' - 30' Units)	2	S	
	Electronic Ignit. Furnace 35M (31' - 35' Units)	3	S	
	Electronic Ignit. Furnace 41M (36' - 40' Units)	4	S	
	Next Size Larger Furnace in Lieu of Standard	5	O	
	Wire for Air Conditioner (1 only)	6	S	
	13.5 Coleman® Air Conditioner	7	O	
	Heat Strip for Air Conditioner	8	O	
	Wire for Extra Air Conditioner	9	O	
	2 - 30# Steel LP Gas Bottles w/ Automatic Reg.	10	S	
	2 - 40# LP Gas Bottles w/ Auto Reg. in Lieu of 2 - 30#	11	O	
	LP See Level Gauges (set of 2)	12	O	
	Rosan® LP Leak Detector	13	O	
	Gas Bottle Light	14	S	
	Gas Bottle Cover	15	S	
	Under Floor Ducted Heat	16	S	
B. APPLIANCES	1303 Dometic® Refrigerator - 3-Way AES	1	S	
	Sibir® 2-Way Refrig. in Lieu of Std. (comparable size)	2	O	
	Range Hood w/Light & Fan	3	S	
	22" 4-Burner Range w/Oven, Top Pilot & Black Glass Door	4	S	
	Double Stainless Steel Sink	5	S	
	Laminated Sink Cover (1 only)	6	S	
	Single Handle Mixing Faucet w/Spray Hose	7	S	
	Single Lever Lavatory & Shower Faucet	8	S	
	Ice Maker	9	O	
	Nutone® Food Center (Blender & Mixer)	10	O	
	Portable Vacuum System	11	O	
	10 Gallon Gas/Electric Water Heater in Lieu of Standard Gas w/Electric	12	O	
C. AWNINGS, DOORS, VENTS & WINDOWS	6 Gal. Atwood® Gas Water Heater w/Elect. Ignition	13	S	
	Water Heater Bypass Kit	14	O	
	Water Purifier	15	O	
	Large Lavatory Sink	16	S	
	Tub/Shower Combination	17	S	
	Bi-Fold Range Cover	18	S	
	Microwave Prep 16"H x 21 1/2"W x 13 1/2"D	19	S	
	Spacemaker Microwave Oven JVM-48	20	O	
	Microwave Oven 16"H x 21 1/2"W x 13 1/2"D	21	O	
	Washer & Dryer Prep (includes plumbing, electric recept, shelf)	22	O	
	Washer & Dryer	23	O	
	Portable Gas Grill	24	O	
D. CABINETS & FURNITURE	Radius Tinted Torque Safety Glass Windows (Hehr®)	1	S	
	36" x 48" Picture Window at Dinette	2	S	
	Opera Window 12" x 48"	3	O	
	36" x 48" Picture Window - Radius Only (each)	4	O	
	48" x 36" Picture Window - Radius Only (each)	5	O	
	48" x 36" Picture Window - Radius Only (each)	6	O	
	48" x 48" Picture Window - Radius Only (each)	7	O	
	Power Roof Vent in Bath Area w/Wall Switch	8	S	
	Non-Power Roof Vent in A/C Location	9	S	
	Roof Vent	10	O	
	Power Roof Vent	11	O	
	30" Primary Door w/Flush Mounted Latch & Dead Bolt Lock	12	S	
E. ELECTRICAL & LIGHTING EQUIPMENT	26" Secondary Door (where applicable)	13	S	
	Front Travel Awning (Travel Trailers)	14	S	
	Front Window & Awning (Fifth Wheels)	15	O	
	Rear Travel Awning	16	O	
	Carter® Side Awning	17	O	
	Center Support for Side Awning	18	O	
	Grab Handle	19	S	
	Woven Folding Door	20	S	
	Wood Folding Door in Lieu of Woven Folding Door	21	O	
	Extra Woven Folding Door	22	O	
	Door Bell	23	O	
	1303 Dometic® Refrigerator - 3-Way AES	1	S	
Sibir® 2-Way Refrig. in Lieu of Std. (comparable size)	2	O		
Range Hood w/Light & Fan	3	S		
22" 4-Burner Range w/Oven, Top Pilot & Black Glass Door	4	S		
Double Stainless Steel Sink	5	S		
Laminated Sink Cover (1 only)	6	S		
Single Handle Mixing Faucet w/Spray Hose	7	S		
Single Lever Lavatory & Shower Faucet	8	S		
Ice Maker	9	O		
Nutone® Food Center (Blender & Mixer)	10	O		
Portable Vacuum System	11	O		
10 Gallon Gas/Electric Water Heater in Lieu of Standard Gas w/Electric	12	O		
6 Gal. Atwood® Gas Water Heater w/Elect. Ignition	13	S		
Water Heater Bypass Kit	14	O		
Water Purifier	15	O		
Large Lavatory Sink	16	S		
Tub/Shower Combination	17	S		
Bi-Fold Range Cover	18	S		
Microwave Prep 16"H x 21 1/2"W x 13 1/2"D	19	S		
Spacemaker Microwave Oven JVM-48	20	O		
Microwave Oven 16"H x 21 1/2"W x 13 1/2"D	21	O		
Washer & Dryer Prep (includes plumbing, electric recept, shelf)	22	O		
Washer & Dryer	23	O		
Portable Gas Grill	24	O		
F. INTERIORS	Air Accumulator Tank	1	S	
	Demand Water System	2	S	
	City Water Hook-Up	3	S	
	35 Gallon Grey Water Tank	4	S	
	35 Gallon Sewage Waste Holding Tank	5	S	
	Fresh Water Tanks			
	Travel Trailers:			
	25 CBD, 27 RB 31 Gallon	6	S	
	29 CBD, 31 CB, 31 CBD, 33 CBD, 33 RBD, 35 CBD, 35 RBD 56 Gallon	7	S	
	Fifth Wheels:			
	23 RBD, 29 RBD, 29 WTD, 29 FBDK 31 Gallon	8	S	
	35 WTRF, 35 WTRF, 40 WTRF, 40 WTRF 35 Gallon	9	S	
32 RBD, 32 WTRF, 32 WTD, 35 FBDK, 35 RBD, 40 FBDK 45 Gallon	10	S		
35 CBWT, 35 WTRF, 35 WTD, 40 CB, 40 CBWT, 40 RBD, 40 WTRF, 40 WTD 56 Gallon	11	S		
G. WATER SYSTEMS	Bumper Cover	1	S	
	Exterior Storage Slide Out Drawers	2	S	
	Roof Rack & Split Ladder	3	O	
	Roof Storage Pod 21 cu. ft.	4	O	
	Roof Storage Pod 10 cu. ft.	5	O	
	H. EXTERIOR	Aluminum Structure (16" Center)	1	S
		Wood Structure in Lieu of Aluminum (Fifth Wheels)	2	O
		Frame Size 8" I-Beam	3	O
		12" Electric Brake	4	S
		Mor-Ryde® Suspension	5	S
		Shock Absorbers	6	S
		15" Wheels	7	S
8.55 Load Range C White Walls		8	S	
Fome-Cor® Insulation Exterior Sidewalls & Roof		9	S	
Fiberglass Insulation in Sidewalls, Floor & Roof		10	S	
Laminated 5/8" Foam Insulation Sidewalls & Roof		11	S	
Enclosed Underbelly w/Laminated 5/8" Foam		12	S	
Double 1/2" Plywood Floor	13	S		
Spare Tire Carrier, Wheel & Cover	14	S		
Chrome Styled Wheel Covers	15	S		
Stabilizer Jacks	16	S		
Extra Set of Stabilizer Jacks	17	O		
Power Hitch Jack (Travel Trailers)	18	O		
Power Hitch Jacks (Fifth Wheels)	19	O		
48" or 54" Fifth Wheel Hitch Plate & Bracket	20	O		
Install Fifth Wheel Hitch	21	O		
I. RUNNING GEAR & CONSTRUCTION	Customer Pick Up	1	O	
	74" Power Slide Out w/Lighting & Recepts	2	O	
	94" Power Slide Out w/Lighting & Recepts	3	O	
	Hurricane Straps (3)	4	O	
	J. MISCELLANEOUS	25 CB Storm Window Set	1	O
		27 RB Storm Window Set	2	O
		29 CB Storm Window Set	3	O
		31 CB Storm Window Set	4	O
		33 CB Storm Window Set	5	O
		35 CB Storm Window Set	6	O
		529 FBDK Storm Window Set	7	O
		532 WTD Storm Window Set	8	O
535 FBDK Storm Window Set		9	O	
540 CB Storm Window Set		10	O	
Storm for Slide Outs		11	O	
K. STORM WINDOWS		Twin or Double Bed	1	S
	Free Standing Sleeper Sofa (see floor plans)	2	S	
	Cabinet Bunk w/Poly Foam Mattress 32"	3	O	
	Stationary Bunk w/Poly Foam Mattress 32"	4	O	
	Queen Bed w/Sheets	5	O	
	Rocker Chair	6	O	
	Pedestal Chair	7	O	
	Wood Folding Chair	8	O	
	Wall Mount Table (27' RB & 31' CB TT; 23' FB, 26' FB, 35' CBWT, 35' WTRF, 35' WTRF, 40' CB, 40' CBWT, 40' WTRF, 40' WTRF FW)	9	S	
	Wall Mount Table (Extra)	10	O	
	Hi-Lo Table (Extra)	11	O	
	Hi-Lo Table in Lieu of Wall Table	12	O	
Counter Top Extension	13	O		
Butcher Block Counter Top	14	O		
Clothes Hamper (CB & FB Models only)	15	O		
Medicine Cabinet	16	S		
Extra Overhead Cabinet (each)	17	O		
Book Case Front Cabinet	18	O		
Book Case Front Angle Cabinet w/TV Shelf	19	O		
Extra Wardrobe at Door Side w/Angle Lower TV Cabinet (RB & CB FW Only) (#131)	20	O		
Omit Front Door & Install Wardrobe (WT FW Only) (#151)	21	O		
Drop Cabinet Top to Bar Level (32' WTRF)	22	O		
Diagonal Cabinet Door Lines	23	S		
Silverware Drawer	24	S		
Dinette w/Pedestal Table (Except 27' RB & 31' CB TT; 23' FB, 26' FB, 35' CBWT, 35' WTRF, 35' WTRF, 40' CB, 40' CBWT, 40' WTRF, 40' WTRF FW)	25	S		
Omit Dinette and Install Table Height Bar	26	O		
Access Doors under Dinette	27	S		
Decorative Headboards	28	S		



Brand new for 1985 — the Kountry Aire Class A Motorhome! It's one of our most artistic achievements to date.

Kountry Kousins

There's nothing like the brand new Kountry Aire Motorhome — except its Kountry Kousin: The Kountry Aire Mini!



Forget-Me-Nots: indigenous to the American countryside. Captured by the artist in the Tennessee Valley.



Decor packages in the Kountry Aire line are especially appealing. Pictured here is "biscuit and blue" in the Class A.



Slide out drawers in the new Motorhome give an unbelievable amount of exterior storage space. (The portable gas grill is also standard with this unit!)



Bluegrass Country — good music, good food, good people. Experience it in Kountry Aire!



Dual fuel conversion is standard on all Kountry Aire motorized vehicles (not available in California).



Closed-circuit rear view monitor (standard) makes maneuvering easier in the Class A.

Both are a delight to own, thanks to the expert craftsmanship and artistic design that goes into every Kountry Aire manufactured.

Pretty as a picture!

Fabrics designed by artists and selected by interior decorators. Cabinetry crafted by the finest artisans. Sleek, aerodynamically engineered exteriors from top designers. And more . . .

Because pretty is as pretty does.

Both Kountry Aire motorized RVs are real performers. Fully equipped with automatic transmission, power steering and brakes, Fome-Cor® insulation in the exterior, and aluminum structure, these Kountry Kousins are as good as they look!

Picture yourself owning one of the beautiful Kountry Kousins!

TRAVELIN' IN THE KOUNTRY AIRE . . . NATURALLY!





The rear bath/bedroom model of the Kountry Aire Mini is one of our most popular.



Room for the whole gang in this spacious Mini.

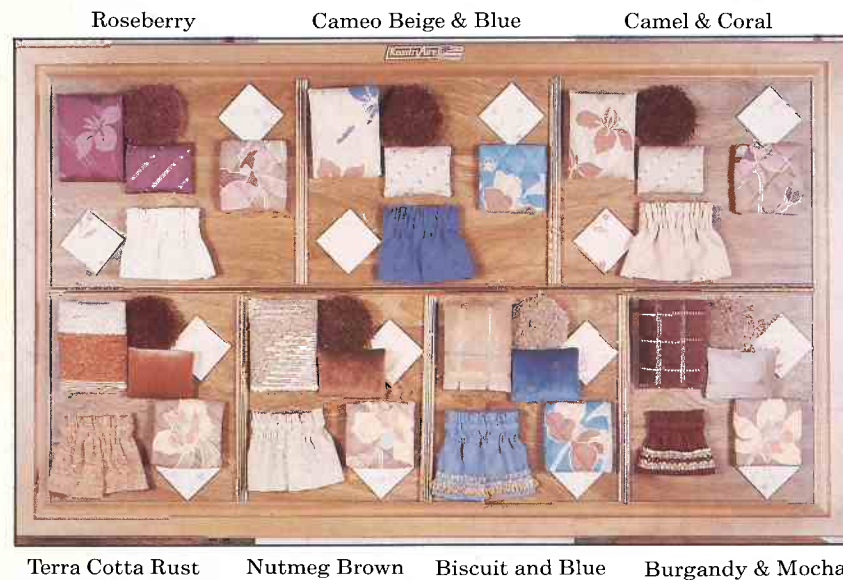

Terra Cotta Rust Nutmeg Brown Biscuit and Blue Burgandy & Mocha

Standard and Optional Features

S = Standard
O = Optional

A. AIR CONDITIONING, GAS & HEATING

Electronic Ignit. Furnace 25M (20'-24' Units)	1	S
Electronic Ignit. Furnace 32M (25'-30' Units)	2	S
Electronic Ignit. Furnace 35M (31'-35' Units)	3	S
Next Size Larger Furnace in Lieu of Standard	4	O
13.5 Coleman® Air Cond. in Living Room (Class A)	5	S
13.5 Coleman® Air Cond. in Bedroom (Class A)	6	S
Wire for Air Conditioner (1 only)	7	S
13.5 Coleman® Air Conditioner	8	O
Heat Strip for Air Conditioner	9	O
Wire for Extra Air Conditioner	10	O
Auxiliary Heater in Bedroom (Class A)	11	S
41 Gallon LP Gas Tank (Mini)	12	S
64 Gallon LP Gas Tank (Class A)	13	S
Defroster Fans (2) (Class A)	14	S
Under Floor Ducted Heat	15	S

B. APPLIANCES

Ice Maker (Class A)	1	S
Ice Maker (Mini)	2	O
1303 Dometic® Refrigerator - 3-Way AES	3	S
Sibir® 2-Way Refrigerator in Lieu of Std. (compar. size)	4	O
Range Hood w/Light & Fan	5	S
22" 4-Burner Range w/Oven, Top Pilot & Black Glass Door	6	S
Double Stainless Steel Sink	7	S
Laminated Sink Cover (1 only)	8	S
Single Handle Mixing Faucet w/Spray Hose	9	S
Single Lever Lavatory & Shower Faucet	10	S
6 Gal. Atwood® Gas Water Heater w/Elect. Ignition	11	S
10 Gal. Gas/Elect. Water Heater in Lieu of Gas	12	O
Water Heater Bypass Kit	13	O
Water Purifier	14	O
Large Lavatory Sink	15	S
Tub/Shower Combination	16	S
Microwave Oven (Class A)	17	S
Microwave Prep (16"H x 21 1/2"W x 13 1/2"D) (Mini)	18	S
Microwave Oven (Mini)	19	O
Spacemaker Microwave Oven JVM 48 in Lieu of Std. (Class A)	20	O
Portable Vacuum System (Class A)	21	S
Portable Vacuum (Mini)	22	O
Gas Grill (Class A)	23	S
Portable Gas Grill (mini)	24	O
Nutone® Food Center (Blender & Mixer) (Class A)	25	S
Nutone® Food Center (Blender & Mixer) (Mini)	26	O
Bi-fold Range Cover	27	S

C. AWNINGS, DOORS, VENTS & WINDOWS

Power Roof Vent in Bath Area w/Wall Switch	1	S
Roof Vent	2	O
Power Roof Vent	3	O
26" Entrance Door w/Flush Mounted Latch & Dead Bolt Lock	4	S
Grab Handle	5	S
Radius Tinted Slider Safety Glass Windows (Hehr®)	6	S
Driver Side Door (Class A)	7	S
Carter® Side Awning (Class A)	8	S
Center Support for Side Awning	9	O
Carter® Side Awning (Mini)	10	O
Exterior Window Shades (Class A)	11	S
36" x 48" Picture Window - Radius Only (each)	12	O
48" x 30" Picture Window - Radius Only (each)	13	O
48" x 36" Picture Window - Radius Only (each)	14	O
48" x 48" Picture Window - Radius Only (each)	15	O
Door Bell	16	O

D. CABINETS & FURNITURE

Twin or Double Bed	1	S
Medicine Cabinet	2	S
Diagonal Cabinet Door Lines	3	S
Silverware Drawer	4	S
Dinette w/Pedestal Table & Picture Window	5	S
Access Doors under Dinette	6	S
Bar in Lieu of Dinette where applicable	7	O
Snack Table on Engine Cover	8	S
Decorative Headboards	9	S

E. ELECTRICAL & LIGHTING EQUIPMENT

AM/FM Stereo w/Cassette, Clock & 4 Speakers (Mini)	1	S
CB AM/FM Stereo w/Cassette, Clock, 4 Speakers, 1 Headphone & Power Antenna (Class A)	2	S
CB Radio w/Antenna (Mini)	3	O
AM/FM Stereo w/Cassette, Clock & 2 Speakers (Bedroom Class A)	4	S
TV Antenna w/2 Jacks	5	S
Built-in Color TV AC/DC (Class A)	6	S
Color TV AC/DC (Mini)	7	O
Hook Up for Cable TV	8	O
Interior Courtesy Lights	9	S
Monitor Panel	10	S
Automatic Wardrobe Lights	11	S
Flourescent Lighting	12	S
1 - 110v GFI Recept Interior	13	S
12v Inverter for Icemaker & 1 Recept (Class A)	14	S
Exterior Recept	15	S
Exterior Security Lights (4)	16	O
Porch Light w/Inside Switch	17	S
Remote Controlled Roof Spot Light (Class A)	18	S
Light Under Hood to Check Fluids (Class A)	19	S
Air Horns (Class A)	20	S
70 AMP Chassis Battery	21	S
1 - 80 AMP Battery (Mini)	22	S

1 - 85 AMP Deep Cycle Battery (Mini)	23	O
2 - 85 AMP Unit Batteries (Class A)	24	S
Battery Isolator	25	S
Auxiliary Start Switch (Class A)	26	S
6.5 k.w. Onan® Generator Set w/2 Start Switches (Class A)	27	S
Generator Prep - Wire & Door only (Mini)	28	S
4.0 k.w. Onan® Generator (Mini)	29	O
40 AMP Converter w/Charger	30	S
110 AMP Alternator (Class A)	31	S
30 AMP Service	32	S
50 AMP Service	33	O
Fire Extinguisher 5 BC	34	S
Fog Lights (Class A)	35	S
Single Automatic Electric Step (Mini)	36	S
Double Automatic Electric Step (Class A)	37	S
Smoke Detector	38	S
Closed Circuit Rear View Monitor (Class A)	39	S

F. INTERIORS

Carpet w/Pad	1	S
3/16" Pecan Paneling	2	S
Wainscotting in Living Room	3	S
Wood Grain Paneling in Lieu of Wainscotting	4	O
Decorative Panels in Bath	5	S
Soft Shade Blinds w/Correlating Tie Back Draperies & Shirred Valances	6	S
Woven Wood Shades w/Shear Curtains & End Panels in Lieu of Soft Shade Blinds	7	O
Padded Automotive Style Vinyl Ceiling (Class A)	8	S
Cushioned Entrance Door Header	9	S
Bedspreads	10	S

G. WATER SYSTEMS

Air Accumulator Tank	1	S
Demand Water System	2	S
City Water Hook-Up	3	S
Grey Water Tanks		
Mini Homes:		
24 RBRD, 26 RBRB, 26 RBB 26 Gallon	4	S
26 RBDB 36 Gallon	5	S
Class A's:		
33 CB, 35 CB 39 Gallon	6	S
Sewage Tanks		
Mini Homes:		
26 RBDB 26 Gallon	7	S
24 RBRD, 26 RBRD, 26 RBB 36 Gallon	8	S
Class A's:		
33 CB, 35 CB 55 Gallon	9	S
Fresh Water Tanks		
Mini Homes:		
24 RBRD, 26 RBRD, 26 RBDB, 26 RBB 32 Gallon	10	S
Class A's:		
33 CB, 35 CB 56 Gallon	11	S

H. EXTERIOR

Exterior Mirrors w/Defrost (Class A)	1	S
Stainless Exterior Mirrors (Mini)	2	S
Roof Rack Ladder	3	S
Exterior Storage Slide Out Drawers	4	S
Stainless Steel Bumpers - Front & Rear (Class A)	5	S
Hitch for Towing Car w/Wire Connector (Class A)	6	S
Hitch for Towing Car w/Wire Connector (Mini)	7	O
Running Boards (Mini)	8	O
Roof Storage Pod 10 cu. ft.	9	O
Roof Storage Pod 21 cu. ft.	10	O

I. RUNNING GEAR & CONSTRUCTION

Aluminum Structure (16" Centers)	1	S
Shock Absorbers	2	S
Fome-Cor® Insulation Exterior Sidewalls & Roof (Mini)	3	S
Fome-Cor® Insulation Exterior Roof (Class A)	4	S
Thermo-board Laminated to Exterior Metal - Sidewall (Class A)	5	S
Fiberglass Insulation Sidewalls, Floor & Roof	6	S
Laminated 5/8" Foam Insulation Sidewalls & Roof	7	S
Double 1/2" Plywood Floor	8	S
Spare Tire, Wheel & Carrier	9	S
Automatic Hydraulic Leveling Jacks (Class A)	10	S
Automatic Hydraulic Leveling Jacks (Mini)	11	S
4-Way Shocks on Front (Class A)	12	S
19.5 Polyester Tires (Class A)	13	S
Radial Tires (Mini)	14	S
Mud Flaps Front & Rear	15	S
Wire Style Wheel Covers	16	S
Dual Fuel Conversion (Except for California)	17	S

J. CHASSIS FEATURES

Automatic Transmission	1	S
Power Steering	2	S
Power Brakes	3	S
Cruise Control	4	S
Custom Tilt Wheel (Class A)	5	S
High Output Heater/Air Conditioner	6	S
6-Way Power Driver Seat (Class A)	7	S
78 Gallon Gasoline Fuel Capacity (Class A)	8	S
41 Gallon Gasoline Fuel Capacity (Ford Mini)	9	S
36 Gallon Gasoline Fuel Capacity (Chevy Mini)	10	S

K. MISCELLANEOUS

Automatic Rewind Cord (Class A)	1	S
Automatic Rewind Water Hose (Class A)	2	S
6-Way Power Passenger Seat (Class A)	4	O
Customer Pick Up	4	O

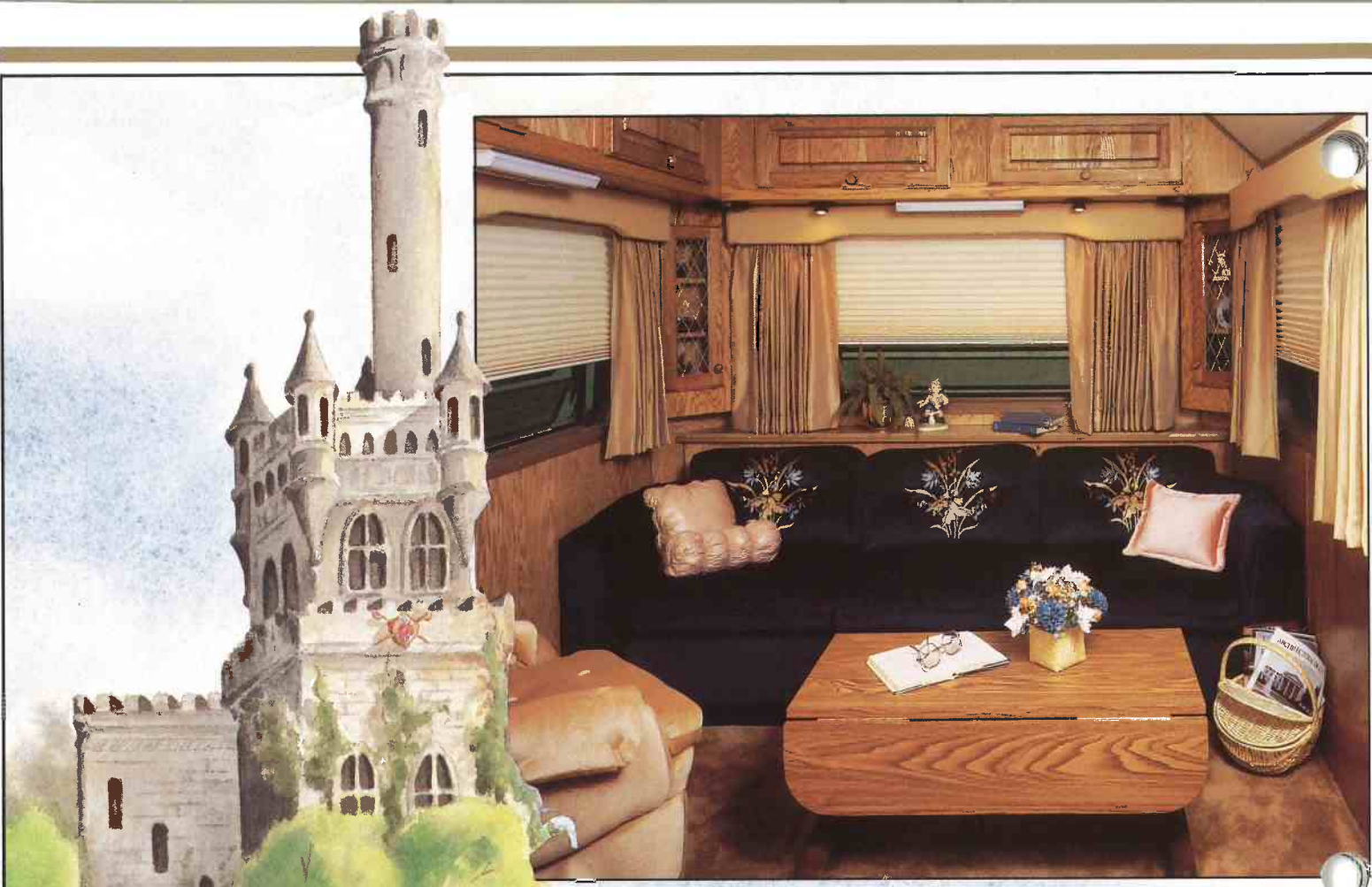

This London Aire Travel Trailer is decorated in Sapphire Blue — one of many jewels suitable for a crown.

London Aire

London Aire — the superlative recreational vehicle — and Newmar Corporation's top-of-the-line. If it's luxury you're looking for, you'll find it here in the London Aire Travel Trailers, Fifth Wheels, Mini Homes and Motorhomes.

Castle: Indigenous to American dreams and legends. Captured by the artist's imagination.



Light and airy fabrics give a breezy atmosphere to this Fifth Wheel bedroom.

Royally Appointed

Once upon a time, deserving kings spent their time — between battles — in absolutely splendid castles. They treated themselves to the very best of everything, because life was short and dragons were fierce!

Times have changed — but conditions really haven't. Kings (and their queens) still need a place to take refuge from day-to-day battles. And life's still too short (and "dragons too fierce") not to make your private time as luxurious as it can be.

Indulge yourself in London Aire . . . because who's more deserving?

Modern-day royalty can take to the road in "towable castles" — like the London Aire Travel Trailer or Fifth Wheel. And these kingly coaches are truly "royally appointed."

Kitchens to delight any gourmet with a 22", four-burner range, full oven and microwave — not to mention the Nutone Food Center, 3-way Dometic refrigerator and automatic ice-maker (all standard!). There's even a portable gas grill for barbeques outdoors!

Opulence abounds in posh interiors of real oak woodwork, sensuously thick carpeting, and designer fabrics and interior decors. And built-in color TV and cable hook-up are standards that raise standards in '85!

To be really appreciated, these fine recreational vehicles must be seen. See for yourself what's meant by "royal treatment!"

HOW YOU TRAVEL IS AS IMPORTANT AS WHERE YOU TRAVEL . . .



Yosemite, where a breath-taking sight meets you at every bend in the road. Just see for yourself!

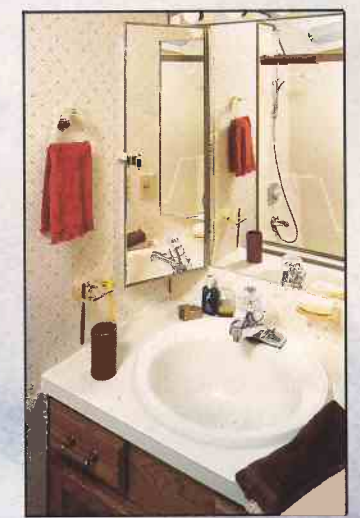

Put yourself in perspective in the three-way mirror of the Fifth Wheel bath.





All London Aire recreational vehicles come equipped with a deluxe monitoring panel.



There are a wide variety of floorplans available in the Lon Aire Travel Trailer line. Shown here is a rear bath model.

Who says you can't take it with you? Our finest Fifth Wheel will convince you otherwise.

Standard and Optional Features

S = Standard
O = Optional

A. AIR CONDITIONING, GAS & HEATING

1	S	Electronic Ignit. Furnace 25M (20'-24' Units)
2	SS	Electronic Ignit. Furnace 32M (25'-30' Units)
3	SS	Electronic Ignit. Furnace 35M (31'-35' Units)
4	SS	Electronic Ignit. Furnace 41M (36'-40' Units)
5	O	Next Size Larger Furnace in Lieu of Standard
6	S	Air Conditioner 13.5 Coleman® (1 only)
7	O	13.5 Coleman® Air Conditioner
8	O	Heat Strip for Air Conditioner
9	O	Wire for Extra Air Conditioner
10	SS	2-40#Steel LP Gas Bottles w/Automatic Regulator
11	SS	Rosan® LP Leak Detector
12	O	LP See Level Gauges (set of 2)
13	S	Gas Bottle Light
14	S	Gas Bottle Cover
15	S	Under Floor Ducted Heat

B. APPLIANCES

1	S	Ice Maker
2	S	Microwave
3	O	Space Maker Microwave Oven JVM 48 in Lieu of Std.
4	S	Nutone® Food Center (Blender & Mixer)
5	S	1303 Dometic® Refrigerator - 3-Way AES
6	S	Range Hood w/Light & Fan
7	S	22" 4-Burner Range w/Oven, Top Pilot & Black Glass Door
8	S	Bi-fold Range Cover
9	SS	Double Stainless Steel Sink
10	SS	Oak Sink Cover (2 each)
11	S	Single Handle Mixing Faucet w/Spray Hose
12	S	Single Lever Lavatory & Shower Faucet
13	S	6 Gallon Atwood® Gas Water Heater w/Elect. Ign.
14	O	6 Gallon Gas/Electric Water Heater in Lieu of Gas
15	O	Water Heater Bypass Kit
16	S	Large Lavatory Sink
17	S	Tub/Shower Combination
18	S	Adjustable Height Shower Head
19	S	Portable Vacuum System
20	S	Portable Gas Grill
21	O	Washer & Dryer Prep (plumbing, elect. recept & shelf)
22	O	Washer & Dryer
23	O	Water Purifier

C. AWNINGS, DOORS, VENTS & WINDOWS

1	S	Power Roof Vent in Bath Area w/Wall Switch
2	O	Roof Vent
3	O	Power Roof Vent
4	S	30" Entrance Door w/Flush Mounted Latch & Dead Bolt Lock
5	S	Front & Rear Travel Awning (Travel Trailers)
6	O	Center Support for Side Awning
7	O	Front Window & Awning (Fifth Wheels)
8	S	Grab Handle
9	SS	Radius Tinted Torque Safety Glass Windows (Hehr®)
10	SS	Wood Folding Door
11	S	Door Bell
12	S	Rear Travel Awning (Fifth Wheels)
13	S	Carter® Side Awning

D. CABINETS & FURNITURE

1	S	Twin or Double Bed
2	S	Free Standing Sleeper Sofa (see floor plans)
3	O	Queen Bed w/Sheet
4	S	Clothes Hamper (CB & FB Models only)
5	S	Medicine Cabinet
6	S	Silverware Drawer

7	S	Dinette w/Pedestal Table
8	SS	Access Doors or Drawers under Dinette
9	SS	Pedestal Chair
10	S	Hi-Lo Table
11	S	Decorative Headboards
12	O	Rocker Chair
13	O	Pedestal Chair (extra)
14	O	Wood Folding Chair
15	O	Hi-Lo Table (Extra)
16	O	Counter Top Extension
17	O	Extra Overhead Cabinet (each)
18	O	Omit Dinette and Install Table Height Bar
19	O	Wall Mount Table (extra)
20	O	L-Shaped Dinette in Lieu of Standard

E. ELECTRICAL & LIGHTING EQUIPMENT

1	S	AM/FM Stereo w/Cassette, Clock & 4 Speakers
2	SS	Color TV AC/DC
3	SS	Hook Up for Cable TV
4	S	TV Antenna w/2 Jacks
5	S	Deluxe Monitor Panel
6	S	Automatic Wardrobe Lights
7	S	Fluorescent Lighting
8	S	Swag Light
9	S	1-110v GFI Recept Interior
10	S	Exterior Recept
11	SS	Porch Light w/Inside Switch
12	SS	1-85 AMP Deep Cycle Battery
13	SS	40 AMP Converter w/Charger
14	S	30 AMP Service
15	S	Fire Extinguisher 10 BC
16	S	Smoke Detector
17	O	Intercom System
18	O	Exterior Security Lights (4)
19	O	50 AMP Service
20	O	4.0 k.w. Onan® Generator
21	O	6.5 k.w. Onan® Generator
22	O	Wire for Telephone
23	O	Generator Prep (Wire & Door only)

F. INTERIORS

1	S	Carpet w/Pad
2	S	1/4" Oak Paneling
3	S	Light Paneling in Bedroom
4	SS	Decorative Panels in Bath
5	S	Sheer Soft Shade w/Traverse Drapery and Matching Cornice Board Valance
6	S	Bedspreads
7	S	Fitted Sheets for Regular Beds
8	O	Vinyl Floor Covering in Lieu of Carpet

G. WATER SYSTEMS

1	S	Air Accumulator Tank
2	SS	Demand Water System
3	S	City Water Hook-Up
4	S	35 Gallon Grey Water Tank
5	S	35 Gallon Sewage Waste Holding Tank
		Fresh Water Tanks
		Travel Trailers:
		25 CBD, 27 RB 31 Gallon
		29 CBD, 31 CB, 31 CBD, 33 CBD, 33 RBD,
		35 CBD, 35 RBD 56 Gallon
		Fifth Wheels:
		23 RBD, 29 RBD, 29 WTD, 29 FBKD 31 Gallon
		35 WTRF, 35 WRFD, 40 WTRF, 40 WRFD 35 Gallon
		32 RBD, 32 WTFB, 32 WTD, 35 FBKD, 35 RBD,
		40 FBKD 45 Gallon
		35 CBWT, 35 WTFB, 35 WTD, 40 CB, 40 CBWT,
		40 RBD, 40 WTFB, 40 WTD 56 Gallon

H. EXTERIOR

1	S	Chrome Auto Style Rear Bumper
2	S	Exterior Storage
3	S	Roof Rack & Split Ladder
4	O	Roof Storage Pod 10 cu. ft.

I. RUNNING GEAR & CONSTRUCTION

1	S	Power Hitch Jack (Travel Trailers)
2	S	Power Hitch Jacks (Fifth Wheels)
3	SS	48" or 54" Fifth Wheel Hitch Plate & Bracket
4	O	Install Fifth Wheel Hitch
5	S	Aluminum Structure
6	S	Double 6" Tube Frame (Except 32' Fifth Wheels)
7	S	12" Electric Brake
8	S	15" Aluminum Wheels
9	S	8.55 Load Range C White Walls
10	S	Fome-Cor® Insulation Exterior Sidewalls & Roof
11	S	Fiberglass Insulation in Sidewalls, Floor & Roof (R5)
12	S	Enclosed Underbelly w/Laminated 5/8" Foam
13	S	Double 1/2" Plywood Floor
14	S	Spare Tire, Wheel, Carrier & Cover
15	S	Stabilizer Jacks

J. MISCELLANEOUS

1	O	Customer Pick Up
---	---	------------------

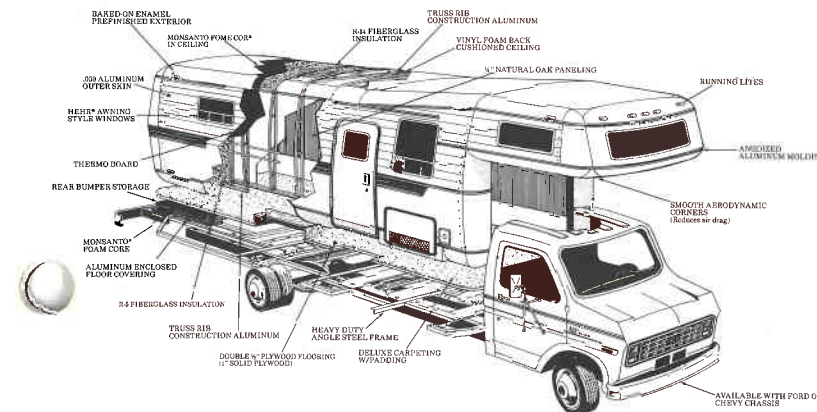

Construction



Bald Eagle: Indigenous to the American hand of the artist. Ideal. Freed here by the hand of the artist.

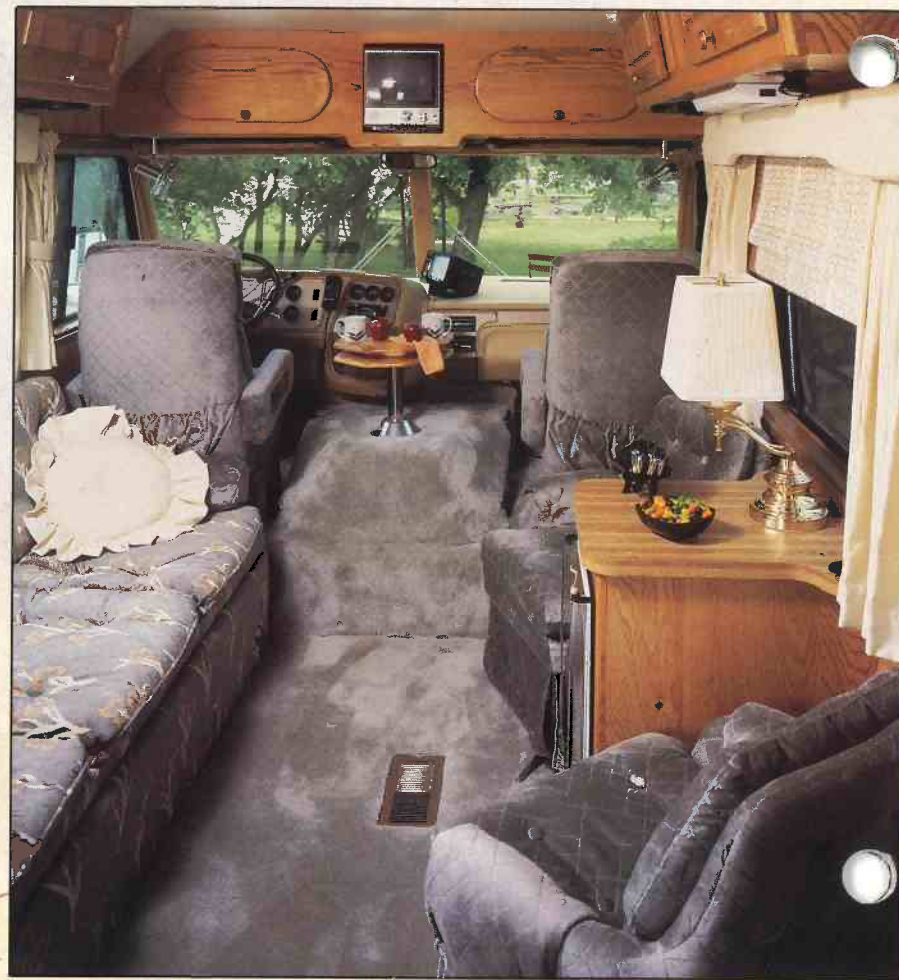

Sleek, sumptuous, completely regal — the London Aire Class A for 1985.

Crowning Achievement

American ingenuity and personal pride in one's work. These are the things that have made our Country foremost among nations.



Courtly cuisine can be prepared easily in this Class A kitchen complete with the finest appliances (all standard!).



See the sights in some of our big cities without worrying about accommodations. You're traveling first-class in London Aire motorized!



Modern-day throne for real road kings in the London Aire Motorhome.

They're the same things that have made Newmar Corporation foremost among recreational vehicle manufacturers.

When imagination soars and work inspires pride, achievement reaches new heights.

Newmar Corporation is proud to present their crowning achievement: the 1985 London Aire line. And nowhere is achievement more apparent than in the motorized vehicles.

Both the London Aire motorhome and mini home seem structurally akin to a powerful bird. Incredibly strong, and durable, yet lightweight enough to glide — thanks to aluminum construction. And a ride so quiet and smooth you'll feel as if you're actually in flight.

A level of luxury rare even in a regal domain.

London Aire has long been noted for pure excellence of design — inside and out. The

sleek dove grey exteriors draw admiring glances everywhere.

And the interiors are a decorator's dream. Standard features on all London Aire motorized vehicles include:

- Air Conditioning
- Automatic Icemaker
- Microwave Oven
- Built-in Color TV
- Portable Vacuum Systems
- Nutone Food Center
- Portable Gas Grill
- Automatic Electric Door Step

The list goes on. But these magnificent vehicles should be experienced to be appreciated. Take flight from the ordinary. Ride in Newmar Corporation's crowning achievement!

HOW YOU TRAVEL IS AS IMPORTANT AS WHERE YOU TRAVEL . . .



Ice on demand from the Dometic Icemaker — another great standard in our top-of-the-line.



Maximum luxury is yours in the London Aire Mini. This one is decorated in Plantation Cocoa.

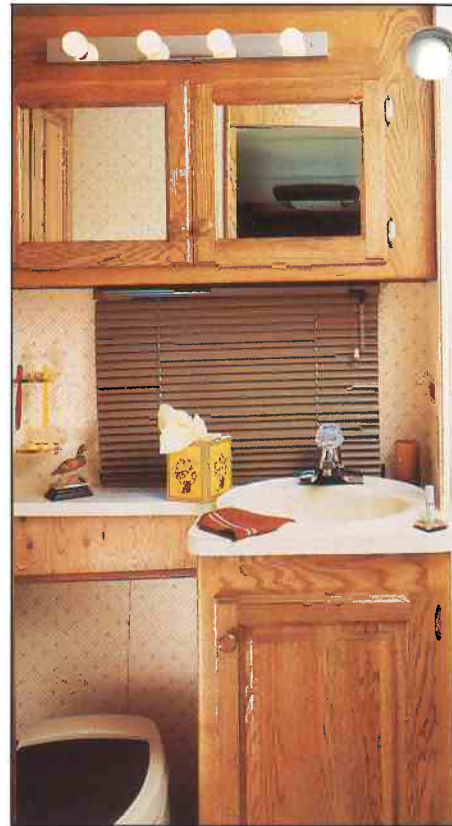

Real oak cabinetry highlights all our London Aires. Shown here is the Mini Home vanity.



Believe it or not — a built-in color TV comes standard in the Class A.

Standard and Optional Features

S = Standard
O = Optional

A. AIR CONDITIONING, GAS & HEATING

Electronic Ignit. Furnace 25M (20' - 24' Units)	1	S
Electronic Ignit. Furnace 32M (25' - 30' Units)	2	S
Electronic Ignit. Furnace 35M (31' - 35' Units)	3	S
Next Size Larger Furnace in Lieu of Standard	4	O
13.5 Coleman® Air Conditioner in Living Room	5	S
13.5 Coleman® Air Conditioner in Bed Room (Class A)	6	S
13.5 Coleman® Air Conditioner	7	O
Heat Strip for Air Conditioner	8	O
Wire for Extra Air Conditioner	9	O
Auxiliary Heater in Bedroom (Class A)	10	S
Gas Bottle Light	11	S
41 Gallon LP Gas Tank (Mini)	12	S
64 Gallon LP Gas Tank (Class A)	13	S
Defroster Fans (2) (Class A)	14	S
Under Floor Ducted Heat	15	S

B. APPLIANCES

Ice Maker	1	S
1303 Dometic® Refrigerator - 3-Way AES	2	S
Range Hood w/Light & Fan	3	S
22" 4-Burner Range w/Oven, Top Pilot & Black Glass Door	4	S
Double Stainless Steel Sink	5	S
Oak Sink Covers (2 each)	6	S
Single Handle Mixing Faucet w/Spray Hose	7	S
Single Lever Lavatory & Shower Faucet	8	S
6 Gallon Atwood® Gas Water Heater w/Elect. Ignition	9	S
6 Gallon Gas/Electric Water Heater in Lieu of Std.	10	O
Water Heater Bypass Kit	11	O
Large Lavatory Sink	12	S
Tub/Shower Combination	13	S
Adjustable Height Shower Head	14	S
Microwave Oven	15	S
Space Maker Microwave Oven JVM in Lieu of Std.	16	O
Portable Vacuum System	17	S
Portable Gas Grill	18	S
Nutone® Food Center (Blender & Mixer)	19	S
Bi-Fold Range Cover	20	S
Water Purifier	21	O

C. AWNINGS, DOORS, VENTS & WINDOWS

Power Roof Vent in Bath Area w/Wall Switch	1	S
Roof Vent	2	O
Power Roof Vent	3	O
30" Entrance Door w/Flush Mounted Latch & Dead Bolt Lock	4	S
Grab Handle	5	S
Radius Tinted Torque Safety Glass Windows (Hehr®)	6	S
Wood Folding Door	7	S
Carter® Side Awning	8	S
Exterior Window Shades (Class A)	9	S
Center Support for Side Awning	10	O
Door Bell	11	S

D. CABINETS & FURNITURE

Twin or Double Bed	1	S
Medicine Cabinet	2	S
Silverware Drawer	3	S
Dinette w/Pedestal Table	4	S
Access Doors or Drawers under Dinette	5	S
Snack Table on Engine Cover	6	S
Decorative Headboards	7	S
Bar in Lieu of Dinette where Applicable	8	O
L-Shaped Dinette in Lieu of Standard	9	O

E. ELECTRICAL & LIGHTING EQUIPMENT

AM/FM Stereo w/Cassette, Clock & 4 Speakers (Mini)	1	S
CB AM/FM Stereo w/Cassette, Clock, 4 Speakers & 1 Headphone & Power Antenna (Class A)	2	S
AM/FM Stereo w/Cassette, Clock & 2 Speakers (Bedroom Class A)	3	S
TV Antenna w/2 Jacks	4	S

Built-in Color TV AC/DC - 2 in CB Models (Class A)	5	S
Hook Up for Cable TV	6	S
Interior Courtesy Lights	7	S
Deluxe Monitor Panel	8	S
Automatic Wardrobe Lights	9	S
Florescent Lighting	10	S
1 - 110v GFI Interior Recept	11	S
12v Inverter for Ice Maker & 1 Recept (Class A)	12	S
Exterior Recept	13	S
Porch Light w/Inside Switch	14	S
Remote Controlled Roof Spot Light (Class A)	15	S
Light Under Hood to Check Fluids (Class A)	16	S
Air Horns (Class A)	17	S
70 AMP Chassis Battery	18	S
1 - 85 AMP Deep Cycle Battery (Mini)	19	S
2 - 85 AMP Deep Cycle Batteries (Class A)	20	S
Battery Isolator	21	S
Auxiliary Start Switch (Class A)	22	S
Generator Prep (Wire & Door Only) (Mini)	23	S
6.5 k.w. Onan® Generator Set w/2 Start Switches (Class A)	24	S
4.0 k.w. Onan® Generator (Mini)	25	O
40 AMP Converter w/Charger	26	S
110 AMP Alternator (Class A)	27	S
30 AMP Service	28	O
50 AMP Service	29	O
Fire Extinguisher 10 BC	30	S
Fog Lights (Class A)	31	S
Single Automatic Electric Step (Mini)	32	S
Double Automatic Electric Steps (Class A)	33	S
Smoke Detector	34	S
Closed Circuit Rear View Monitor (Class A)	35	S
Exterior Security Lights	36	O
CB Radio & Antenna (Mini)	37	O

F. INTERIORS

Carpet w/Pad	1	S
1/4" Oak Paneling	2	S
Light Panel in Bedroom	3	S
Decorative Panels in Bath	4	S
Soft Shade Blinds w/Correlating Tie Back Draperies & Shirred Valance (Mini)	5	S
Wood Woven Shades w/Sheer Curtains & End Panels in Lieu of Soft Shades	6	O
Padded Automotive Style Vinyl Ceiling	7	S
Cushion Entrance Door Header	8	S
Bedspreads	9	S

G. WATER SYSTEMS

Air Accumulator Tank	1	S
Demand Water System	2	S
City Water Hook-Up	3	S
Grey Water Tanks		
Mini Homes:		
24 RBRD, 26 RBRD, 26 RBDB 26 Gallon	4	S
26 RBB 36 Gallon	5	S
Class A's:		
33 CB, 35 CB 39 Gallon	6	S
Sewage Tanks		
Mini Homes:		
24 RBRD 26 Gallon	7	S
24 RBRD, 26 RBRD, 26 RBB 36 Gallon	8	S
Class A's		
33 CB, 35 CB 55 Gallon	9	S
Fresh Water Tanks		
Mini Homes:		
24 RBRD, 26 RBRD, 26 RBDB, 26 RBB 32 Gallon	10	S
Class A's:		
33 CB, 35 CB 56 Gallon	11	S

H. EXTERIOR

Exterior Mirrors w/Defrost (Class A)	1	S
Stainless Exterior Mirrors (Mini)	2	S
Roof Rack Ladder	3	S
Exterior Storage w/Slide Out Drawers (Class A)	4	S
Chrome Auto-Style Read Bumper (Mini)	5	S
Stainless Steel Bumpers - Front & Rear (Class A)	6	S
Hitch for Towing Car w/Wire Connector (Class A)	7	S
Hitch for Towing Car w/Wire Connector (Mini)	8	O
Roof Storage Pods	9	O
Running Boards (Mini)	10	S

I. RUNNING GEAR & CONSTRUCTION

Aluminum Structure	1	S
Shock Absorbers	2	S
Form-Cor® Insulation Exterior Sidewalls & Roof	3	S
Fiberglass Insulation in Sidewalls, Floor & Roof (R5)	4	S
Double 1/2" Plywood Floor	5	S
Spare Tire, Wheel, Carrier, & Cover	6	S
Automatic Hydraulic Leveling Jacks (Class A)	7	S
4-Way Shocks on Front (Class A)	8	S
Radial Tires & Aluminum Wheels (Class A)	9	S
Radial Tires (Mini)	10	O
Mud Flaps - Front & Rear	11	S
Wire Style Wheel Covers (Mini)	12	S
Dual Fuel Conversion (Except for California)	13	S
Automatic Hydraulic Leveling Jacks (Mini)	14	O

J. CHASSIS FEATURES

Automatic Transmission	1	S
Power Steering	2	S
Power Brakes	3	S
Cruise Control	4	S
Custom Tilt Wheel (Class A)	5	S
High Output Heater/Air Conditioner	6	S
6 Way Power Driver Seat (Class A)	7	S
78 Gallon Gasoline Fuel Capacity (Class A)	8	S
41 Gallon Gasoline Fuel Capacity (Ford Mini)	9	S
36 Gallon Gasoline Fuel Capacity (Chevy Mini)	10	S

K. MISCELLANEOUS

Automatic Rewind Cord (Class A)	1	S
Automatic Rewind Water Hose (Class A)	2	S
Customer Pick Up	1	O

Decor Packages

Plantation Cocoa

Ginger Nut



Sterling Silver

Sapphire Blue

Special Features

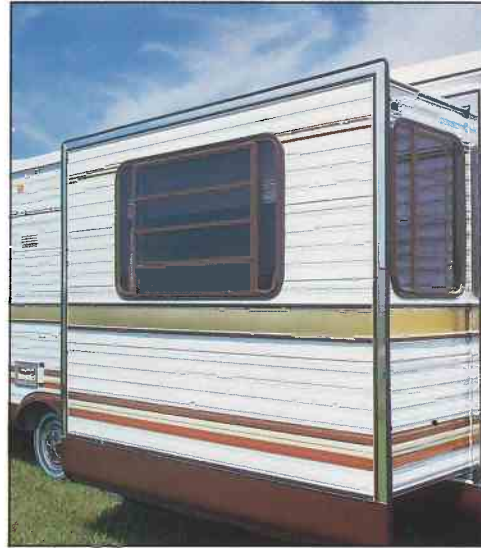

Outer Space—an exterior view of the Kountry Aire Fifth Wheel power slide-out.



Fitted sheets are standard in all Kountry Aire and London Aire Towables.



12 volt Electric Tongue Jack, standard on London Aire Travel Trailers.



Watch it! Cable TV that is. The hook-up is standard on all London Aire units.



Kountry Aire Fifth Wheels all have extra room outside! Note the spacious exterior slide-out drawer.



Center Bath Class A bedrooms all come equipped with an AM-FM stereo w/cassette and clock.



Brand name, high quality furniture is used throughout all Kountry Aire and London Aire Lines.



Bring yourself to a new level! Stabilizer jacks are standard on all Kountry Aire and London Aire Travel Trailers and Fifth Wheels.

Construction

Kountry Kraftsmanship

Every one of us at Newmar Corporation — from the “top” on down — realizes that a lot of our own self-esteem is wrapped up in the work that we do. That’s why we work so hard to do things right. It’s almost as though we put our signature on everything we do.

Every RV we build is a solidly constructed aluminum superstructure for maximum lateral strength. The floor is double 1/2” plywood, giving you a 1” solid wood floor. The underbelly is completely enclosed. All wiring is code-approved copper.

Coaches are double insulated, with foam and fiberglass insulation featured in the sidewalls and roof. The aerodynamically designed exteriors reduce wind resistance and give you better gas mileage. Included are large dual holding tanks, and large fresh water tanks with demand systems. And there’s plenty of exterior storage space.

Every unit we manufacture is built to RVIA approved standards and codes for your complete satisfaction, safety and comfort.

At Newmar Corporation, we take pride in our craft. If you’d like to come and “watch us work,” scheduled plant tours are given Monday through Friday.

Every coach undergoes rigorous inspections periodically during the construction process.



Roof lines are aerodynamically rounded to reduce wind resistance.

Coaches have dual insulation plus Monsanto Fome-Cor®. You’ll be cool in the summer and warm in the winter, wherever you travel or live in your Kountry Aire.



Weather tight exterior seal being applied.



Be Our Guest!

Each year, hundreds of visitors from around the United States, and even some foreign countries tour the Newmar facilities. We're proud of our community, our people, our home offices and especially proud of the coaches our craftsmen produce for the recreational vehicle industry.

Newmar Corporation is one of the most respected names in the RV business. The primary reason is quality. The quality that is engineered into every unit produced.

That quality begins here in Nappanee, Indiana.

Our facility is spread over 26 acres, and includes over 150,000 square feet of working space that includes executive offices, production facilities, engineering and drafting departments, IBM computer technology, research and development, and a large sales and customer service division.

Our artisans include some of the finest craftsmen in the country. And the result is some of the most beautiful and popular recreational vehicles in the world — Kountry Lite, Kountry Aire, and London Aire!

But, why not come visit us and see for yourself!

(Information contained in this brochure is presented as factually as possible and is current at time of printing. The manufacturer reserves the right at any time to make changes in product design or specifications at its sole option without notice. By the time you receive your copy, some information may have been updated. Please consult your dealer concerning optional extras and/or specification changes or corrections.)

An aerial view of the Newmar facilities.



Corporate headquarters.

Editor's Note:

I'd like to extend my personal thanks to you for your interest in Newmar Corporation.

I hope that the preceding pages have further sparked your interest, and that you've enjoyed the manner in which we've chosen to present our product. Just as there's an art to capturing nature in watercolor, there's an art to building fine RV's too. I'm proud of the product designed and crafted here. I believe that our people are masters at their craft. A good deal of our success comes from our belief not only in ourselves but in good old-fashioned values as well.

In the years to come, we will strive for continued excellence in all our products. Because, at Newmar Corporation, we know that a thing of beauty must also endure.

Newmar Corporation,

A handwritten signature in cursive script that reads "Mahlon a Miller".

Mahlon Miller
President
Chairman of the Board

Newmar Corporation

P. O. Box 30 • Nappanee, Indiana 46550
(219) 773-7791

**London Aire**

1984 LA Mini



Luxury Mini Motorhomes

A WORLD AHEAD . . .



READY TO GO ...

Even before you enter the Luxury London Aire Mini Motorhome you know it's special. The baked-on dove gray exterior aluminum is truly unique and beautiful. Aerodynamic lines with rounded corners provide smooth exterior appearance, less wind resistance on the road, and improved gasoline mileage. The London Aire Mini is designed to travel the road to your heart's content, with minimum buffeting and wind-shearing that plague many coach owners. The ride is smoother, you arrive rested, refreshed, and ready to enjoy your "home away from home."

The London Aire superstructure is a truss type construction with all aluminum sidewall and contoured perimeter. Interior construction includes aluminum roof ribs with straight inner wall design. Double insulation is home-style fiberglass and a thermo board attached to exterior skin metal to effectively shield both hot and cold temperatures. Exterior trim moldings are anodized heat-treated metal similar to today's automotive design. In addition there is a 25-gauge aluminum underbelly below the floor and, of course, angle steel is framed to chassis before floor mounting.

WON'T YOU COME IN...

When you step inside the London Aire, you immediately realize it is **solid** luxury. Solid because the floor is doubled $\frac{5}{8}$ inch glued and bolted to the outriggers. Interior sidewalls are a full $\frac{1}{4}$ inch quality paneling which is glued and screwed to the aluminum rib truss superstructure.

MAKE YOURSELF COMFORTABLE...

Comfortable indeed. The understated luxury of London Aire interiors is beautiful. Not flashy or garish, but quiet-class that is all pervasive. You may choose from color schemes which include Plantation Cocoa - Seafoam Green - Dusty Rose - Sapphire Blue - and Champagne Accent. Beautiful fabrics, elegant draperies, couches and chairs that spoil you with comfort, and wipe clean with a damp cloth, and finally, rich, thick carpeting. But it's just the beginning, for, like beautiful homes, what you don't see adds to your comfort and well-being. But, we'll get to that a little later.



London Aire



EVERY COACH IS HANDCRAFTED...

Look around a bit more. Notice the oak paneling. And the $\frac{3}{4}$ inch solid oak cabinet frames with 1 inch solid oak cabinet fronts ($\frac{1}{4}$ inch oak paneling glued over $\frac{3}{4}$ inch solid wood). Even the cabinets are mounted to the aluminum truss superstructure of the sidewall and ceiling with special self-tapping screws. Solid. Then there is a tile floor covering at cabinet bottom for easy cleaning. All overhead cabinets have double bottoms as well.

AMENITIES ABOUND...

In addition to your microwave, you'll find a four-burner kitchen range with a pilot light for the oven and top burners. The gourmet kitchen has a single swivel lever faucet and plenty of work area. This may be a mini, but it has maxi everything! Even the gas/electric refrigerator is larger than those usually found in a mini motorhome.



London Aire



NICE TOUCHES...

Would milady like a microwave, a blender, perhaps tinted windows, perfect accoustics for the AM/FM cassette stereo or quiet conversation, air conditioning, electronic furnace, lighted vanity in the bath, power TV antenna and more? Good, because most are standard items in every London Aire produced! Raining outside? Let the fresh air in with the awning style tinted windows.



Audiovox AM/FM cassette sound system.



ONAN 110V, 4000W generator.



Custom designed Zip Dee awning.



Dometic Microwave (convection or space-saver microwave also available).



FIVE NEW DECOR COLORS

- Plantation Cocoa
- Seafoam Green
- Dusty Rose
- Sapphire Blue
- Champagne Accent

AND THERE'S MORE...

London Aire fiberglass bath tubs and showers were custom-designed and custom-built to fit our coaches and to fit you! Tub and sink have home-style overflow, and you have 30-gallons of fresh water, demand style, with double waste-holding tanks. There is an automatic on-off micro switch for convenient wardrobe lighting. In addition, your lighting package includes indirect 12-volt fluorescent lighting built right into the foam, custom-back ceiling. Restful. You also have lighting where you need it most, one under the outside entry step and one beside the entry door. All lighting is standard, including generous exterior running lights. Finally, when you snuggle in for the night, the generous sized cab-over bed has more than two full feet of clearance from mattress to ceiling.



FIVE 27' LONDON AIRE MODELS OFFER THE FOLLOWING ATTRIBUTES AND ACCOMMODATIONS

THE LIVING/SLEEPING AREAS

Sculptured carpeting with pad • Overhead bed with thick foam mattress surrounded by 3 windows • Swivel captains chair in cab • Comfortable sofa bed • Swivel chair & TV cabinet in living area (some models) • Large dinette (converts into bed, some models) • Removable pedestal tables • Wood woven shades with valance on windows.

THE KITCHEN

Natural oak cabinetry • Oven/range with bi-fold cover and lighted, power vented hood • Stainless steel sink with single lever faucet • Refrigerator with freezer • Pull-out pantry • Sculptured carpeting • Wood drawers with separated silverware area.

THE BATH

Large fiberglass tub with shower • Telephone-type, adjustable height shower head • Home style lavatory with medicine cabinets and 3 mirrors • Light bar over vanity • Oak vanity cabinet • Large linen closet • Stool with padded lid • Carpeting • Power vent.

THE EXTERIOR AND CONSTRUCTION

Dove gray baked on enamel exterior • Welded aluminum superstructure • 4 tail lights with backup lights • Automotive-type chrome bumper • Chrome spare tire cover • Rear exterior storage • 25' exterior power cord • 65 lb. L.P. gas bottle with gauge • Tinted awning type safety windows.

SPECIAL STANDARD ATTRactions

Self contained with dual holding tanks • 13,500 BTU air conditioning • High performance water heater • 2-door gas-electric refrigerator • AM-FM stereo with 10 oz. speakers and cassette • Power rotating TV antenna • Automatic lights in wardrobes • 12-volt fluorescent lighting • Total insulation • R-7 sidewalls • R-14 ceiling & floors • Five decors including Plantation Cocoa, Seafoam Green, Dusty Rose, Sapphire Blue and Champagne Accent.

AUTOMOTIVE SPECIAL STANDARD ATTRactions

Comfort-tilt power steering • Power brakes • Automatic transmission • AM-FM stereo with cassette • Automotive air conditioning • Cruise control • Carpeted cab • Cushioned, rotating bucket seats • Dual rear wheels • Wheel covers.

SPECIAL OPTIONAL ATTRactions

Central vacuum system • Garbage disposal • Water purifier • Monitor panel • Door bell • Microwave oven • Zip-Dee awning • Rear ladder with roof storage podd • Electric exterior door step • CB radio.

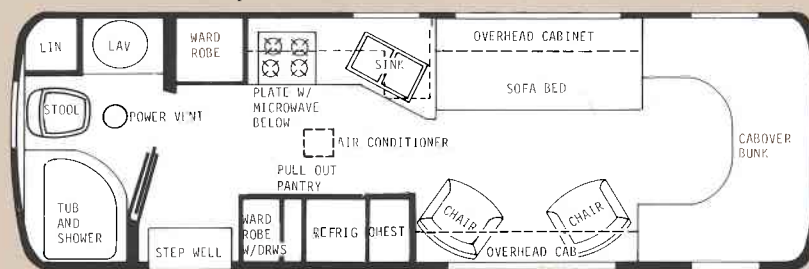

The 27' PRINCE 3 - Dry wt. 9600 lbs. - Overall length 26' 9"

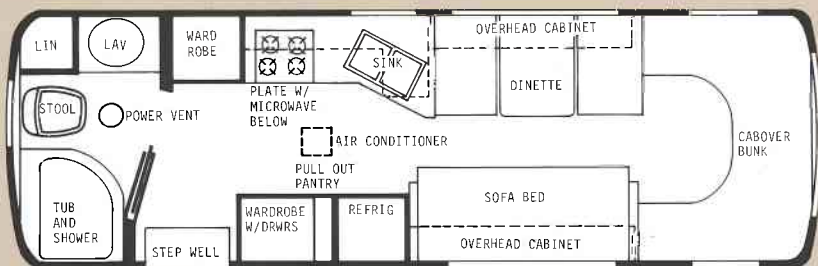

The 27' PRINCE 1 - Dry wt. 9600 lbs. - Overall length 26' 9"

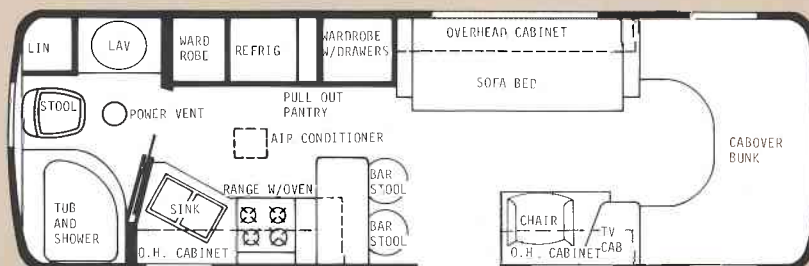

The 27' DUKE - Dry wt. 9600 lbs. - Overall length 26' 9"

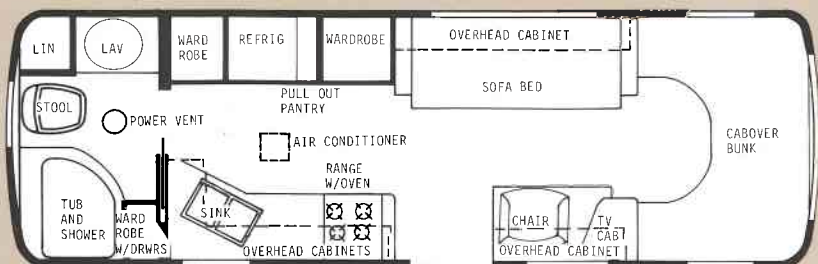

The 27' PRINCE 2 - Dry wt. 9600 lbs. - Overall length 26' 9"

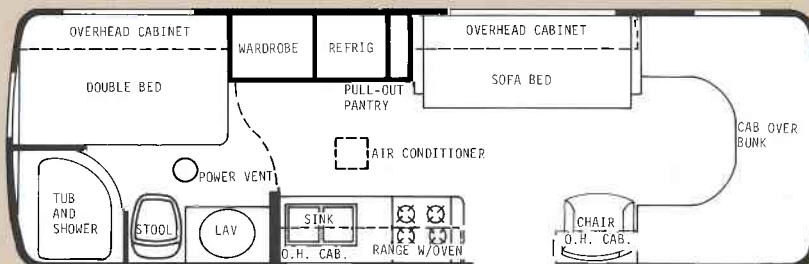

The 27' PRINCESS - Dry wt. 9600 lbs. - Overall length 26' 9"



Newmar Industries, Inc.
P.O. Box 30
Nappanee, IN 46550

All features listed are not standard on all models. Some equipment shown in photographs is optional. All weights listed are approximate. Due to London Aire's policy of continuing improvements features and specifications are subject to change without prior notice.

Each London Aire meets all requirements of the RVIA, Recreational Vehicle Industry Association; the ANSI, American National Standards Institute; and all state and federal codes.



LONDON AIRE MINI HOME

	27' Princess	27' Prince I	27' Prince II	27' Prince III	27' Duke
Dry Weight	9,600 lb.	9,600 lb.	9,600 lb.	9,600 lb.	9,600 lb.
GVWR - Chevy	10,500 lb.	10,500 lb.	10,500 lb.	10,500 lb.	10,500 lb.
GVWR - Ford	11,000 lb.	11,000 lb.	11,000 lb.	11,000 lb.	11,000 lb.
Fresh Water	30 gal.	30 gal.	30 gal.	30 gal.	30 gal.
Gray Water	25 gal.	36 gal.	36 gal.	36 gal.	36 gal.
Sewage Water	36 gal.	25 gal.	25 gal.	25 gal.	25 gal.
Propane	65 lb.	65 lb.	65 lb.	65 lb.	65 lb.
Water Heater	6 gal.	6 gal.	6 gal.	6 gal.	6 gal.
Dimensions:					
Total Height	9' - 9"	9' - 9"	9' - 9"	9' - 9"	9' - 9"
Interior Height	78"	78"	78"	78"	78"
Exterior Width	94"	94"	94"	94"	94"
Interior Width	87½"	87½"	87½"	87½"	87½"
Total Length	26' - 10"	26' - 10"	26' - 10"	26' - 10"	26' - 10"
Mattress to ceiling in Cabover	25"	25"	25"	25"	25"
Exterior Storage	10 cu. ft.	10 cu. ft.	10 cu. ft.	10 cu. ft.	10 cu. ft.
Sleeping Capacity	6	5	4	4	4
Bed Sizes - Cabover	58" x 80"	58" x 80"	58" x 80"	58" x 80"	58" x 80"
Sofabed	41" x 74"	41" x 74"	41" x 74"	41" x 74"	41" x 74"
Dinette	—	34" x 72"	—	—	—
Double Bed	46" x 74"	—	—	—	—
Wheel Base - Ford	188"	188"	188"	188"	188"
Wheel Base - Chevy	179"	179"	179"	179"	179"



1984



London Aire



A WORLD AHEAD IN TIME AND DESIGN



YOU ARE CORDIALLY INVITED TO VISIT US...

Our main office headquarters and production facilities are located on Highway 6 just west of Nappanee, Indiana. Personal tours of our office and production facilities are given daily, Monday through Friday, from 10:00 a.m. until 4:00 p.m. The complete line of luxurious Newmar recreational vehicles are built by the finest craftsmen in the world. We would be delighted to have you spend some time with us and see the London Aire, Kountry Aire and Kountry Lite vehicles in the various phases of construction. You'll find our facilities designed for both comfort and efficiency that includes IBM computer technology, research and development facilities, engineering and drafting departments, and a large customer services division.



Every effort has been made to make the information contained in this brochure as factual as possible right up to the time it was printed. However, some information may have been updated by the time you receive your copy. Although most of the features and specifications in your London Aire are current, please consult your dealer concerning optional extras, and/or specification changes.

AN ENTIRE FLEET OF LUXURIOUS DOVE GRAY LONDON AIRE FIFTH WHEELS AND TRAVEL TRAILERS AWAITS YOUR SELECTION



Some RV manufacturers allow you to choose. At London Aire, we invite you to select from the finest. London Aire is built from the inside out, because what you can't see, or may not be aware of, is just as important as what you can see. For example, your London Aire has a six-inch tubular steel frame, and a glued, double $\frac{5}{8}$ inch plywood floor which is bolted to the frame for solidity. The steel frame includes z-bar cross members for lateral strength. The superstructure of every London Aire is a truss type construction with roof ribs. Exterior sidewalls and roof line are contoured for a better drag coefficient, ease of pulling, less wind resistance, and therefore improved mileage. However, in-

side walls are of a vertical straight line design for better space utilization. Coaches are double insulated with fiberglass and thermo board attached to exterior skin metal to provide an effective heat and cold shield. Exterior trim moldings are anodized heat-treated metal commonly used in automotive construction. There is a 25-gauge aluminum underbelly below the floor. Every construction technique has been implemented to make London Aire solid on the road or at home. Finally, your coach rides on world famous Rub-R-Ride (Comfort Core™) suspension.



Select from five interior design color combinations: Plantation Cocoa (L-841), Seafoam Green (L-842), Dusty Rose (L-843), Sapphire Blue (L-844), Champagne Accent (L-845).



LUXURY IS STANDARD

The understated luxury of London Aire interiors is breathtaking. Select from five color schemes, all new for this model year. Beautiful, rich fabrics, elegant draperies, upholstery and carpeting are all color coordinated to make your coach picture perfect and quietly comfortable. Even clean-up is easier because of the new wipe-clean upholstery finishes.



Picture yourself relaxing or entertaining in this spacious and luxurious Sapphire Blue living room.



OUR DREAM KITCHENS GIVE MOM A VACATION TOO!

In addition to your microwave, you'll find a four-burner range with pilot light for top burners and oven. You have plenty of preparation area and storage room. And the gas/electric refrigerator is larger than those usually found in an RV. In fact, you might like this kitchen better than your kitchen at home!



OPTIONAL:

Microwave shown is standard. Also available in space saver, and convection microwave.



WE'VE MADE THINGS EASIER FOR THE MAN OF THE COACH TOO!

Electric hitch with fingertip control. Lighting in areas where you need it the most, including the hitch, generator compartment, drain outlet, under the outside entry step and next to entry door. Plenty of storage area. All exterior storage compartments have key locks and are weather-tight rubber sealed. Aluminum LP gas bottles with gauge and automatic change-over regulator. Outside drain control valve-pull levers are extended for easy access, but enclosed. Outside stabilizer jacks are quick crank-down type, frame mounted for travel and camping convenience. 30,000 BTU electric ignition furnace on all models except 35'-40' fifth wheels which have 34,000 BTU.



The electric hitch raises or lowers the coach with fingertip control.



The best awning in the business is one that works easy. Ours does.



Special chrome-ringed hitch light lets you see anytime, and conveniently lights up propane tanks too.

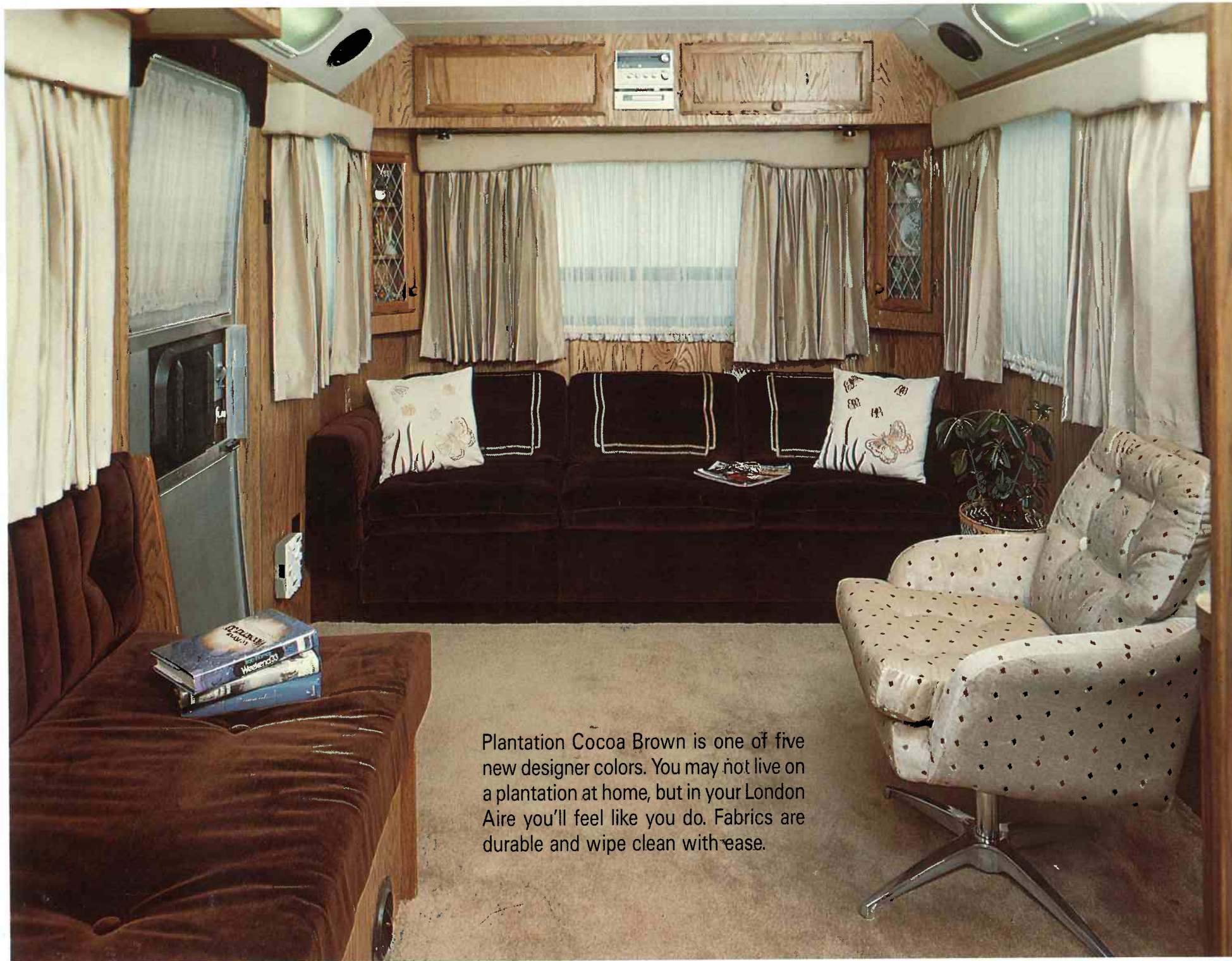

Plantation Cocoa Brown is one of five new designer colors. You may not live on a plantation at home, but in your London Aire you'll feel like you do. Fabrics are durable and wipe clean with ease.



TOWABILITY PLUS

What kinds of tow vehicles are suitable for your London Aire? Usually a wide variety because of the aerodynamic design of the London Aire travel trailers and fifth wheels. We also manufacture a matching tow vehicle. Ask your dealer, or call our customer service department for more information.

NICE TOUCHES FOR HOME AWAY FROM HOME

Would milady like a microwave, a blender, perhaps tinted windows, an AM/FM cassette stereo, air conditioning, electronic furnace, lighted vanity in the bath, power TV antenna? More? Good. Because most are standard items in every London Aire produced, and optional extras are reasonably affordable. Awning style windows let fresh air in whatever the weather outside.





Champagne Accent Decor

THE ARTIST'S TOUCH

It's reflected in everything about your London Aire coach. The designer fabrics, the color combinations, the stereo accoustics, the recessed fluorescent overhead lighting and the tinted windows. Rich oak paneling and oak cabinetry with tile flooring beneath were selected for beauty, durability and to provide a warm background which accents whichever color combination you choose.



DESIGNER COLORS



No matter which fabric and color combination you select, it is color coordinated to be correct and pleasing to the eye. Choose from Plantation Cocoa, Seafoam Green, Dusty Rose, Sapphire Blue, or Champagne Accent.

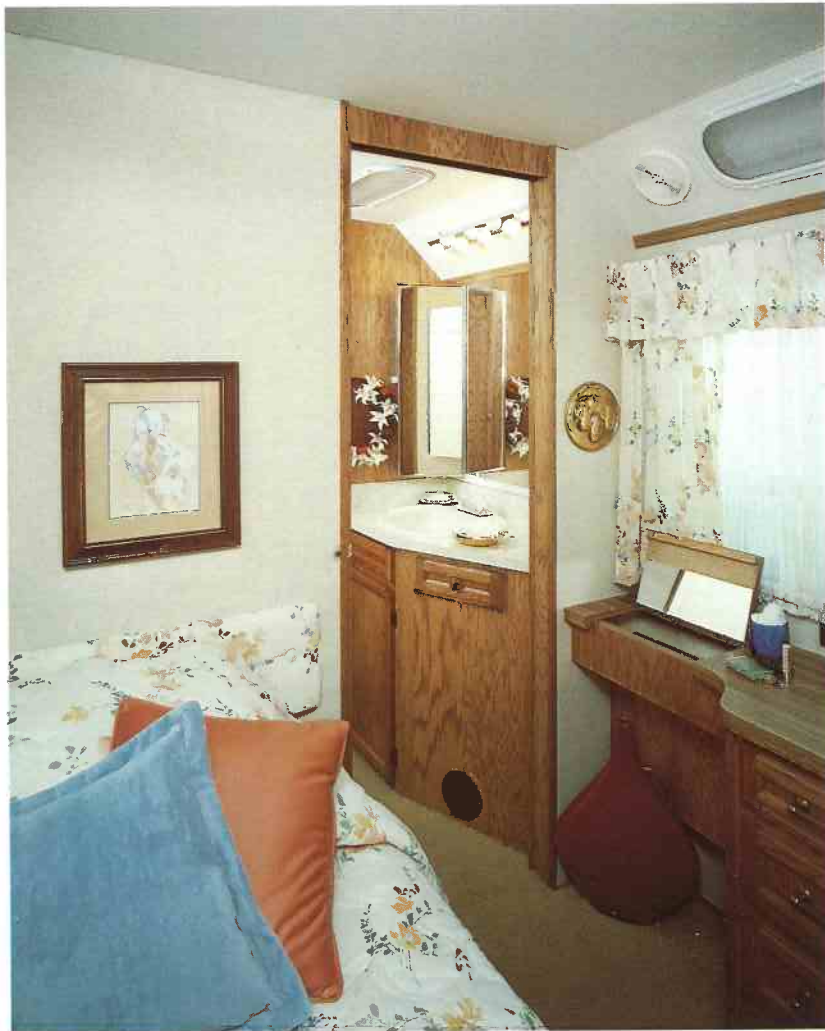

AND THERE'S MORE

London Aire fiberglass bath tubs and showers were custom-designed and custom-built to fit our coaches and to fit you! Tub and sink have a home-style overflow. The spacious vanity with large mirror also has generous lighting for milady at makeup time. There are 40 gallons of fresh water, demand style, so you don't run out, and two 35 gallon holding tanks.





	27' VISCOUNT	27' BARON	29' VISCOUNT	29' BARON	31' VISCOUNT	31' BARON	33' VISCOUNT	33' BARON	33' BARON W/DINETTE	33' VISCOUNT W/DINETTE	35' BARON W/DINETTE	35' VISCOUNT W/DINETTE	35' VISCOUNT	35' BARON	528' STATESMAN	528' BARON	532' STATESMAN	532' BARON	535' STATESMAN	535' BARON	540' STATESMAN	540' BARON	540' VISCOUNT	540' KINGSMAN
KITCHEN																								
Oven/range with bi-fold cover	Std.	Std.	Std.	Std.	Std.	Std.	Std.	Std.	Std.	Std.	Std.	Std.	Std.	Std.	Std.	Std.	Std.	Std.	Std.	Std.	Std.	Std.	Std.	Std.
Double stainless steel sink	Std.	Std.	Std.	Std.	Std.	Std.	Std.	Std.	Std.	Std.	Std.	Std.	Std.	Std.	Std.	Std.	Std.	Std.	Std.	Std.	Std.	Std.	Std.	Std.
Gas/electric refrigerator	Std.	Std.	Std.	Std.	Std.	Std.	Std.	Std.	Std.	Std.	Std.	Std.	Std.	Std.	Std.	Std.	Std.	Std.	Std.	Std.	Std.	Std.	Std.	Std.
Pull-out pantry	Std.	Std.	Std.	Std.	Std.	Std.	Std.	Std.	Std.	Std.	Std.	Std.	Std.	Std.	Std.	Std.	Std.	Std.	Std.	Std.	Std.	Std.	Std.	Std.
Oak cabinets	Std.	Std.	Std.	Std.	Std.	Std.	Std.	Std.	Std.	Std.	Std.	Std.	Std.	Std.	Std.	Std.	Std.	Std.	Std.	Std.	Std.	Std.	Std.	Std.
Microwave oven	Opt.	Opt.	Opt.	Opt.	Opt.	Opt.	Opt.	Opt.	Opt.	Opt.	Opt.	Opt.	Opt.	Opt.	Opt.	Opt.	Opt.	Opt.	Opt.	Opt.	Opt.	Opt.	Opt.	Opt.
Central vacuum system	Opt.	Opt.	Opt.	Opt.	Opt.	Opt.	Opt.	Opt.	Opt.	Opt.	Opt.	Opt.	Opt.	Opt.	Opt.	Opt.	Opt.	Opt.	Opt.	Opt.	Opt.	Opt.	Opt.	Opt.
Garbage disposal	Opt.	Opt.	Opt.	Opt.	Opt.	Opt.	Opt.	Opt.	Opt.	Opt.	Opt.	Opt.	Opt.	Opt.	Opt.	Opt.	Opt.	Opt.	Opt.	Opt.	Opt.	Opt.	Opt.	Opt.
LIVING ROOM																								
TV cabinet/Shelf	Std.	Std.	Std.	Std.	Std.	Std.	Std.	Std.	Std.	Std.	Std.	Std.	Std.	Std.	Std.	Std.	Std.	Std.	Std.	Std.	Std.	Std.	Std.	Std.
Sofa bed	Std.	Std.	Std.	Std.	Std.	Std.	Std.	Std.	Std.	Std.	Std.	Std.	Std.	Std.	Std.	Std.	Std.	Std.	Std.	Std.	Std.	Std.	Std.	Std.
AM-FM stereo radio	Std.	Std.	Std.	Std.	Std.	Std.	Std.	Std.	Std.	Std.	Std.	Std.	Std.	Std.	Std.	Std.	Std.	Std.	Std.	Std.	Std.	Std.	Std.	Std.
Rocker chair	Opt.	Opt.	Opt.	Opt.	Opt.	Opt.	Opt.	Opt.	Opt.	Opt.	Opt.	Opt.	Opt.	Opt.	Opt.	Opt.	Opt.	Opt.	Opt.	Opt.	Opt.	Opt.	Opt.	Opt.
Pedestal chair	Opt.	Opt.	Opt.	Opt.	Opt.	Opt.	Opt.	Opt.	Opt.	Opt.	Std.	Opt.	Opt.	Opt.	Opt.	Opt.	Opt.	Opt.	Opt.	Opt.	Opt.	Opt.	Opt.	Opt.
BEDROOM																								
6" mattress	Std.	Std.	Std.	Std.	Std.	Std.	Std.	Std.	Std.	Std.	Std.	Std.	Std.	Std.	Std.	Std.	Std.	Std.	Std.	Std.	Std.	Std.	Std.	Std.
Automatic lighted wardrobes	Std.	Std.	Std.	Std.	Std.	Std.	Std.	Std.	Std.	Std.	Std.	Std.	Std.	Std.	Std.	Std.	Std.	Std.	Std.	Std.	Std.	Std.	Std.	Std.
Double bed	Std.	No	Std.	No	Std.	No	Std.	No	No	Std.	No	Std.	Std.	No	Std.	Std.	Std.	Std.	Std.	Std.	Std.	Std.	Std.	Std.
Twin beds	Opt.	Std.	Opt.	Std.	Opt.	Std.	Opt.	Std.	Std.	Opt.	Std.	Opt.	Opt.	Std.	Std.	Std.	Std.	Std.	Opt.	Opt.	Opt.	Opt.	Opt.	Opt.
BATH																								
Adjustable height shower head	Std.	Std.	Std.	Std.	Std.	Std.	Std.	Std.	Std.	Std.	Std.	Std.	Std.	Std.	Std.	Std.	Std.	Std.	Std.	Std.	Std.	Std.	Std.	Std.
Power vent	Std.	Std.	Std.	Std.	Std.	Std.	Std.	Std.	Std.	Std.	Std.	Std.	Std.	Std.	Std.	Std.	Std.	Std.	Std.	Std.	Std.	Std.	Std.	Std.
36" x 40" fiberglass shower	Std.	Std.	Std.	Std.	Std.	Std.	Std.	Std.	Std.	Std.	Std.	Std.	Std.	Std.	Std.	Std.	Std.	Std.	Std.	Std.	Std.	Std.	Std.	Std.
Medicine cabinet, 3 mirrors	Std.	Std.	Std.	Std.	Std.	Std.	Std.	Std.	Std.	Std.	Std.	Std.	Std.	Std.	Std.	Std.	Std.	Std.	Std.	Std.	Std.	Std.	Std.	Std.
ADDITIONAL COMFORTS																								
Tinted safety windows	Std.	Std.	Std.	Std.	Std.	Std.	Std.	Std.	Std.	Std.	Std.	Std.	Std.	Std.	Std.	Std.	Std.	Std.	Std.	Std.	Std.	Std.	Std.	Std.
High performance water heater	Std.	Std.	Std.	Std.	Std.	Std.	Std.	Std.	Std.	Std.	Std.	Std.	Std.	Std.	Std.	Std.	Std.	Std.	Std.	Std.	Std.	Std.	Std.	Std.
12V demand water supply	Std.	Std.	Std.	Std.	Std.	Std.	Std.	Std.	Std.	Std.	Std.	Std.	Std.	Std.	Std.	Std.	Std.	Std.	Std.	Std.	Std.	Std.	Std.	Std.
R-14 and R-7 insulation	Std.	Std.	Std.	Std.	Std.	Std.	Std.	Std.	Std.	Std.	Std.	Std.	Std.	Std.	Std.	Std.	Std.	Std.	Std.	Std.	Std.	Std.	Std.	Std.
Generator	No	No	No	No	No	No	No	No	No	No	No	No	No	Opt.	Opt.	Opt.	Opt.	Opt.	Opt.	Opt.	Opt.	Opt.	Opt.	Opt.
Intercom system	Opt.	Opt.	Opt.	Opt.	Opt.	Opt.	Opt.	Opt.	Opt.	Opt.	Opt.	Opt.	Opt.	Opt.	Opt.	Opt.	Opt.	Opt.	Opt.	Opt.	Opt.	Opt.	Opt.	Opt.
Door bell	Opt.	Opt.	Opt.	Opt.	Opt.	Opt.	Opt.	Opt.	Opt.	Opt.	Opt.	Opt.	Opt.	Opt.	Opt.	Opt.	Opt.	Opt.	Opt.	Opt.	Opt.	Opt.	Opt.	Opt.
Furnace (BTUs) ducted-forced air	30M	30M	30M	30M	30M	30M	30M	30M	30M	30M	34M	34M	34M	34M	30M	30M	30M	30M	34M	34M	34M	34M	34M	34M
34,000 BTU furnace	Opt.	Opt.	Opt.	Opt.	Opt.	Opt.	Opt.	Opt.	Opt.	Std.	Std.	Std.	Std.	Opt.	Opt.	Opt.	Opt.	Std.	Std.	Std.	Std.	Std.	Std.	
Hi-Lo table	Opt.	Opt.	Opt.	Opt.	Opt.	Opt.	Opt.	Opt.	Opt.	Opt.	Opt.	Opt.	Opt.	Opt.	Opt.	Opt.	Opt.	Opt.	Opt.	Opt.	Opt.	Opt.	Opt.	Opt.
1/4" paneling	Std.	Std.	Std.	Std.	Std.	Std.	Std.	Std.	Std.	Std.	Std.	Std.	Std.	Std.	Std.	Std.	Std.	Std.	Std.	Std.	Std.	Std.	Std.	Std.
Padded vinyl ceiling	Std.	Std.	Std.	Std.	Std.	Std.	Std.	Std.	Std.	Std.	Std.	Std.	Std.	Std.	Std.	Std.	Std.	Std.	Std.	Std.	Std.	Std.	Std.	Std.
Cushioned vinyl floor tile	Opt.	Opt.	Opt.	Opt.	Opt.	Opt.	Opt.	Opt.	Opt.	Opt.	Opt.	Opt.	Opt.	Opt.	Opt.	Opt.	Opt.	Opt.	Opt.	Opt.	Opt.	Opt.	Opt.	Opt.
Sculptured carpet and pad	Std.	Std.	Std.	Std.	Std.	Std.	Std.	Std.	Std.	Std.	Std.	Std.	Std.	Std.	Std.	Std.	Std.	Std.	Std.	Std.	Std.	Std.	Std.	Std.
EXTERIOR																								
Spare Tire and wheel	Opt.	Opt.	Opt.	Opt.	Opt.	Opt.	Opt.	Opt.	Opt.	Opt.	Opt.	Opt.	Opt.	Opt.	Opt.	Opt.	Opt.	Opt.	Opt.	Opt.	Opt.	Opt.	Opt.	Opt.
LP gas bottles with gauges	Std.	Std.	Std.	Std.	Std.	Std.	Std.	Std.	Std.	Std.	Std.	Std.	Std.	Std.	Std.	Std.	Std.	Std.	Std.	Std.	Std.	Std.	Std.	Std.
Front power jacks	Std.	Std.	Std.	Std.	Std.	Std.	Std.	Std.	Std.	Std.	Std.	Std.	Std.	Std.	Opt.	Opt.	Opt.	Opt.	Opt.	Opt.	Opt.	Opt.	Opt.	Opt.
Chrome auto-style rear bumper	Std.	Std.	Std.	Std.	Std.	Std.	Std.	Std.	Std.	Std.	Std.	Std.	Std.	Std.	Std.	Std.	Std.	Std.	Std.	Std.	Std.	Std.	Std.	Std.
Zip-Dee side awning	Opt.	Opt.	Opt.	Opt.	Opt.	Opt.	Opt.	Opt.	Opt.	Opt.	Opt.	Opt.	Opt.	Opt.	Opt.	Opt.	Opt.	Opt.	Opt.	Opt.	Opt.	Opt.	Opt.	Opt.
Aluminum wheels	Std.	Std.	Std.	Std.	Std.	Std.	Std.	Std.	Std.	Std.	Std.	Std.	Std.	Std.	Std.	Std.	Std.	Std.	Std.	Std.	Std.	Std.	Std.	Std.
13,500 roof air conditioner	Std.	Std.	Std.	Std.	Std.	Std.	Std.	Std.	Std.	Std.	Std.	Std.	Std.	Std.	Std.	Std.	Std.	Std.	Std.	Std.	Std.	Std.	Std.	Std.
Heat in roof air conditioner	Opt.	Opt.	Opt.	Opt.	Opt.	Opt.	Opt.	Opt.	Opt.	Opt.	Opt.	Opt.	Opt.	Opt.	Opt.	Opt.	Opt.	Opt.	Opt.	Opt.	Opt.	Opt.	Opt.	Opt.
Front/rear awnings flush mounted	Std.	Std.	Std.	Std.	Std.	Std.	Std.	Std.	Std.	Std.	Std.	Std.	Std.	Std.	Fr.NA	Fr.NA	Fr.NA	Fr.NA	Fr.NA	Fr.NA	Fr.NA	Fr.NA	Fr.NA	Fr.NA
Power TV antenna	Std.	Std.	Std.	Std.	Std.	Std.	Std.	Std.	Std.	Std.	Std.	Std.	Std.	Std.	Std.	Std.	Std.	Std.	Std.	Std.	Std.	Std.	Std.	Std.

Some features are optional. Features and specifications are subject to change without prior notice.

THE FIFTH WHEEL TRAILERS

Your London Aire Fifth Wheel comes in 10 different plans and four different lengths. The designs are more than just plans, they are achievements in space arrangement and weight distribution.

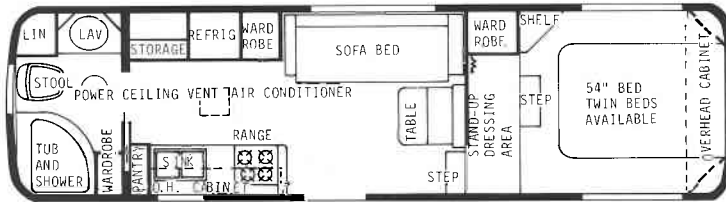

28' Baron F.W. - Dry Wt. 6900 lbs. - Hitch Wt. 1750 lbs. - Overall Length 28' 9"

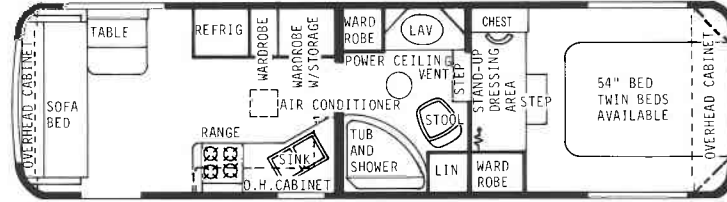

28' Statesman F.W. - Dry Wt. 6900 lbs. - Hitch Wt. 1750 lbs. - Overall Length 28' 9"

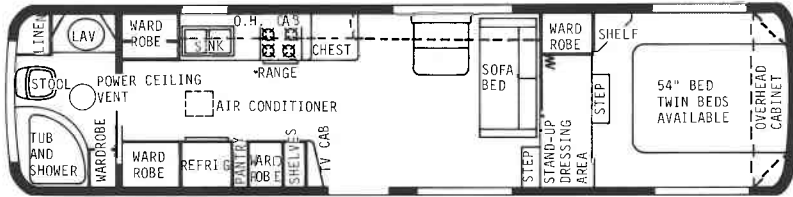

32' Baron F.W. - Dry Wt. 7200 lbs. - Hitch Wt. 1750 lbs. - Overall Length 32' 9"

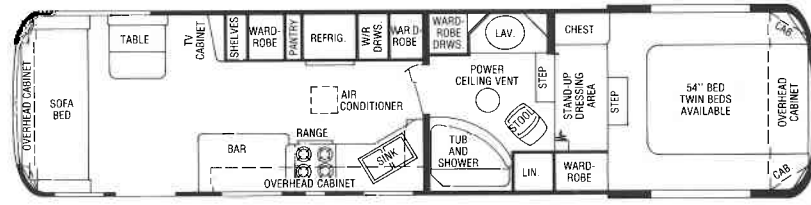

32' Statesman F.W. - Dry Wt. 7200 lbs. - Hitch Wt. 1750 lbs. - Overall Length 32' 9"

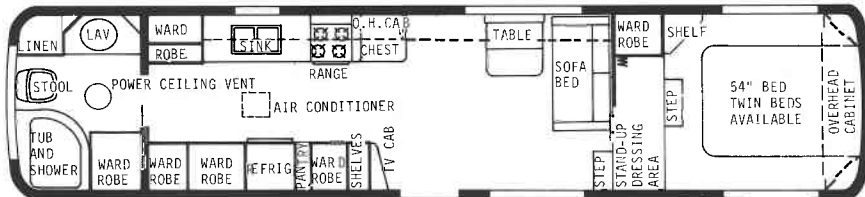

35' Baron F.W. - Dry Wt. 7600 lbs. - Hitch Wt. 1800 lbs. - Overall Length 35' 9"

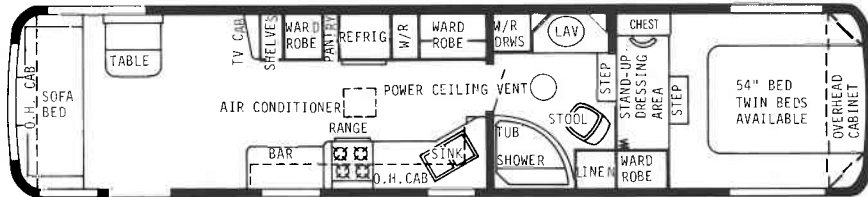

35' Statesman F.W. - Dry Wt. 7600 lbs. - Hitch Wt. 1800 lbs. - Overall Length 35' 9"

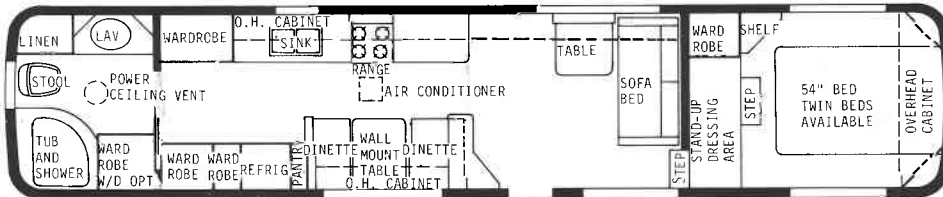

40' Baron F.W. - Dry Wt. 8800 lbs. - Hitch Wt. 1750 lbs. - Overall Length 40'

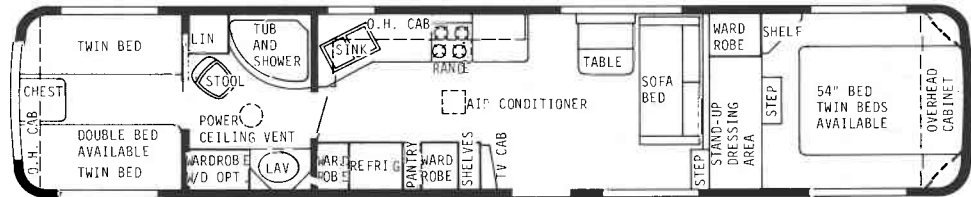

40' Viscount F.W. - Dry Wt. 8800 lbs. - Hitch Wt. 1750 lbs. - Overall Length 40'

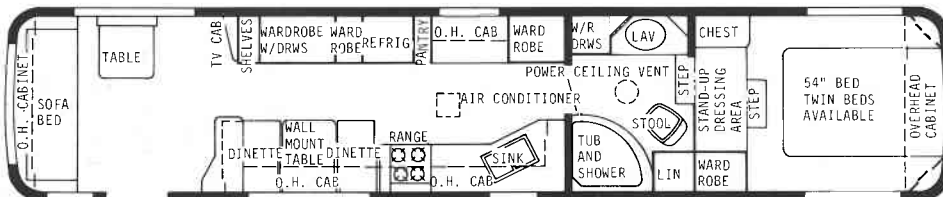

40' Statesman F.W. - Dry Wt. 8800 lbs. - Hitch Wt. 1750 lbs. - Overall Length 40'

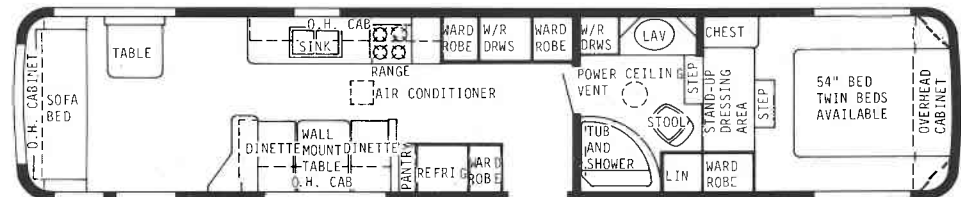

40' Kingsman F.W. - Dry Wt. 8800 lbs. - Hitch Wt. 1750 lbs. - Overall Length 40'

THE TRAVEL TRAILERS

Pick the plan and size that best suits your needs. Fourteen plans in five lengths from which to choose. Each plan is a masterpiece in RV know-how and experience.

more standard features

80 amp battery with 40 amp converter • Fire extinguisher • Double door refrigerator, gas and electric combination • 2 or more exterior storage areas • Completely enclosed undercarriage • 12" electric brakes • 1 1/4" plywood flooring • Anodized autostyle exterior trim moldings • Baked enamel on exterior metal • 2, 24" stabilizing jacks • 25' exterior power cord • Large fresh water tank • 2, large waste holding tanks • Aluminum L.P. bottles with gauges • Self style closers on overhead cabinet doors • Wardrobes with finished interior walls and micro-switch lighting.

Some available features
 Water purifier
 Washer and dryer
 Microwave oven
 Blender in kitchen.

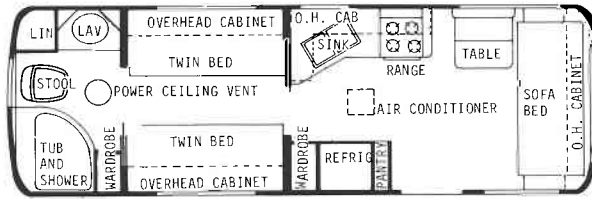

27' Baron T.T. - Dry Wt. 5400 lbs. - Hitch Wt. 700 lbs.
 - Overall Length 27' 8"

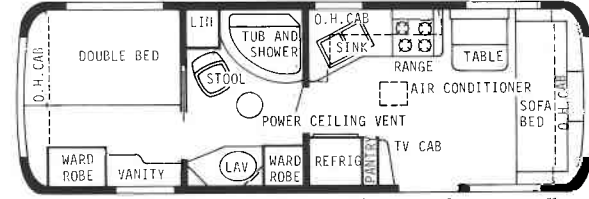

27' Viscount T.T. - Dry Wt. 5400 lbs. - Hitch Wt. 700 lbs.
 - Overall Length 27' 8"

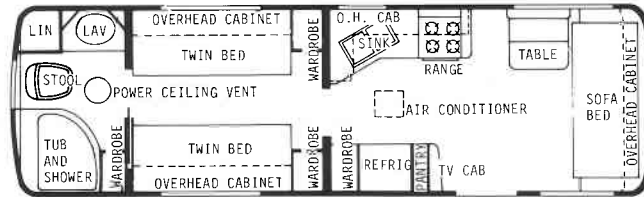

29' Baron T.T. - Dry Wt. 5700 lbs. - Hitch Wt. 800 lbs.
 - Overall Length 29' 8"

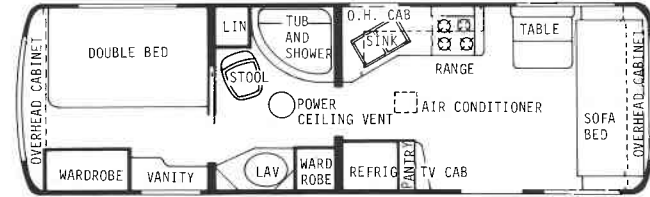

29' Viscount T.T. - Dry Wt. 5700 lbs. - Hitch Wt. 800 lbs.
 - Overall Length 29' 8"

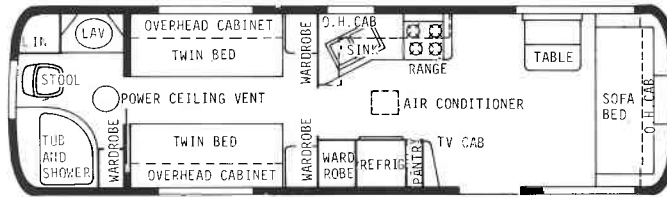

31' Baron T.T. - Dry Wt. 6000 lbs. - Hitch Wt. 800 lbs.
 - Overall Length 31' 8"

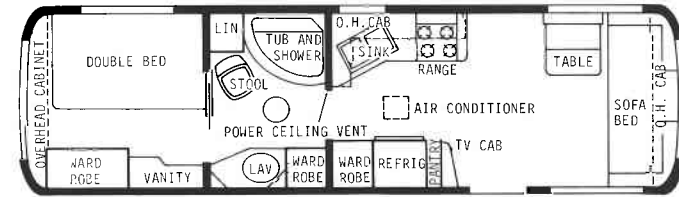

31' Viscount T.T. - Dry Wt. 6000 lbs. - Hitch Wt. 800 lbs.
 - Overall Length 31' 8"

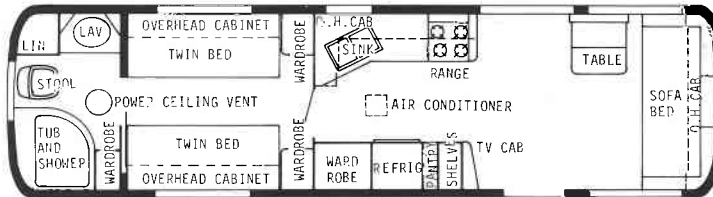

33' Baron T.T. - Dry Wt. 6300 lbs. - Hitch Wt. 900 lbs.
 - Overall Length 33' 8"

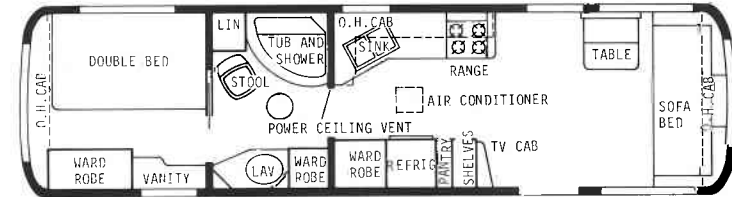

33' Viscount T.T. - Dry Wt. 6300 lbs. - Hitch Wt. 900 lbs.
 - Overall Length 33' 8"

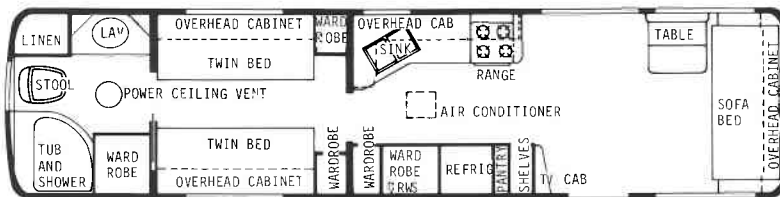

35' Baron T.T. - Dry Wt. 6600 lbs. - Hitch Wt. 900 lbs. - Overall Length 35' 8"

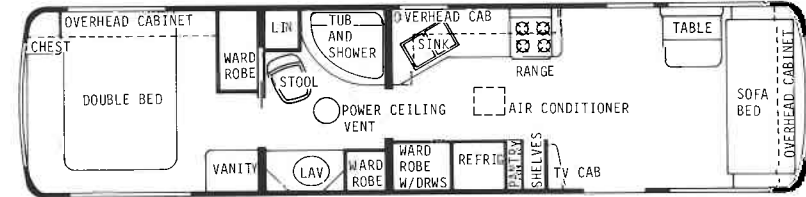

35' Viscount T.T. - Dry Wt. 6600 lbs. - Hitch Wt. 900 lbs. - Overall Length 35' 8"

London Aire
 Newmar Industries, Inc.
 P.O. Box 30
 Nappanee, IN 46550-0030

THE TRAVEL TRAILERS

NEW SIDE-DINETTE FLOOR PLANS!

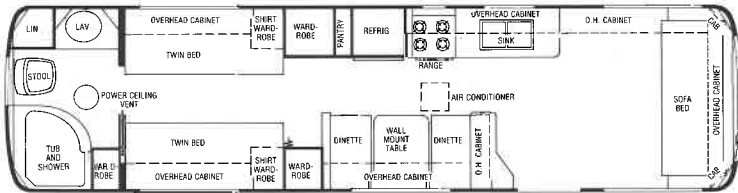

33' Baron TT - with Dinette

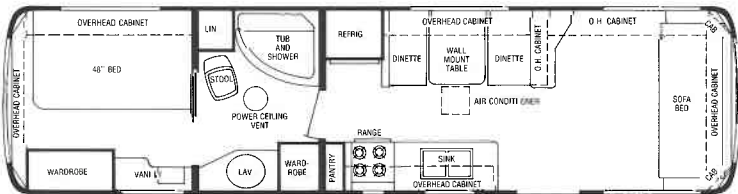

33' Viscount TT - with Dinette

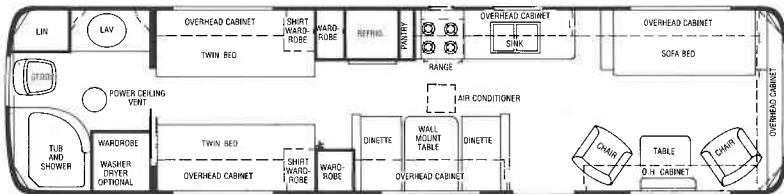

35' Baron TT - with Dinette



35' Viscount TT - with Dinette

RUB•R•RIDE SUSPENSION (COMFORT CORE™)

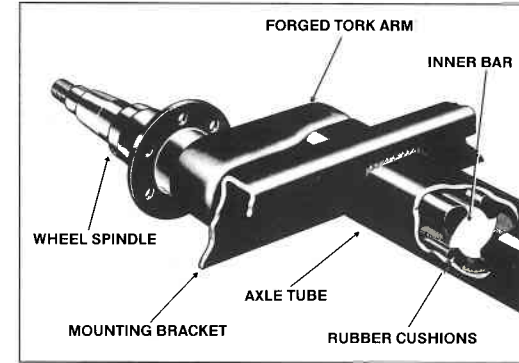

WHAT LONDON AIRE'S AERODYNAMICS DOES FOR YOU

The flowing lines of the aerodynamic contours, of a London Aire recreational vehicle, reduce air drag substantially, provide it with ideal stability in handling and towing. This permits effortless driving, a smooth quiet ride and better mileage per gallon.



A TRADITION OF QUALITY CRAFTSMANSHIP...

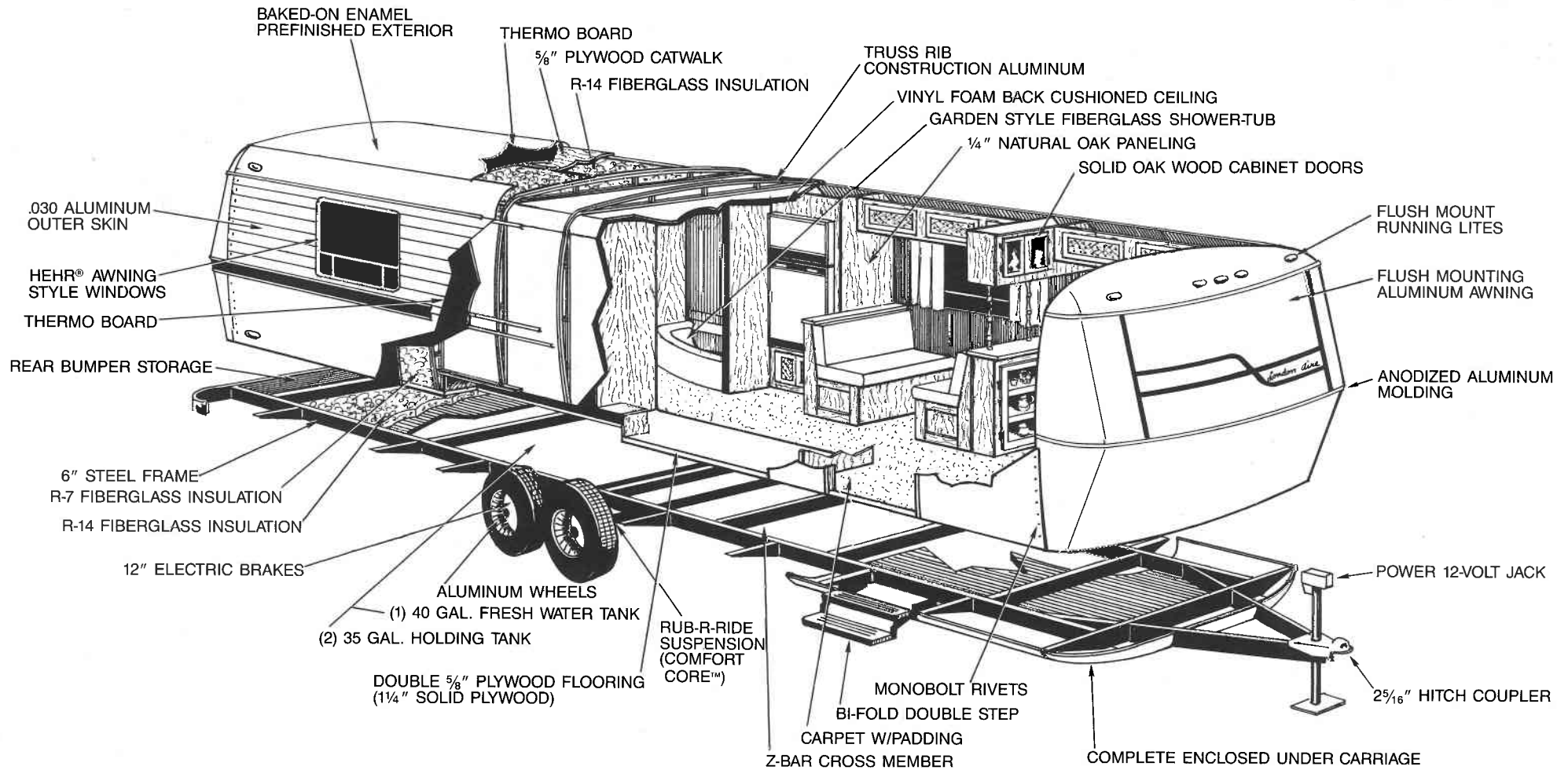



All weights shown are approximate.

All London Aire features and options are not included. Your dealer has a complete list.

Each London Aire meets all requirements of the RVIA, Recreational Vehicle Industry Association; the ANSI, American National Standards Institute; and all state and federal codes.

Some features shown in photographs are optional. Features and specifications are subject to change without prior notice.

London Aire, Newmar Industries, Inc., P.O. Box 30
Nappanee, Indiana 46550
Telephone: 1-800-348-5208

London Aire®

A WORLD AHEAD

London Aire®



IN TIME AND DESIGN

MINI MOTOR HOMES



Comfortable indeed. The understated luxury of London Aire interiors is beautiful. Not flashy or garish, but quiet-class that is all pervasive. You may choose from color schemes which include Plantation Cocoa - Seafoam Green - Dusty Rose - Sapphire Blue - and Champagne Accent. Beautiful fabrics, elegant draperies, couches and chairs that spoil you with comfort, and wipe clean with a damp cloth, and finally, rich, thick carpeting. But it's just the beginning, for, like beautiful homes, what you don't see adds to your comfort and well-being.

Even before you enter the Luxury London Aire Mini Motorhome you know it's special. The baked-on dove gray exterior aluminum is truly unique and beautiful. Aerodynamic lines with rounded corners provide smooth exterior appearance, less wind resistance on the road, and improved gasoline mileage. The London Aire Mini is designed to travel the road to your heart's content, with minimum buffeting and wind-shearing that plague many coach owners. The ride is smoother, you arrive rested, refreshed, and ready to enjoy your "home away from home."



Type of Construction

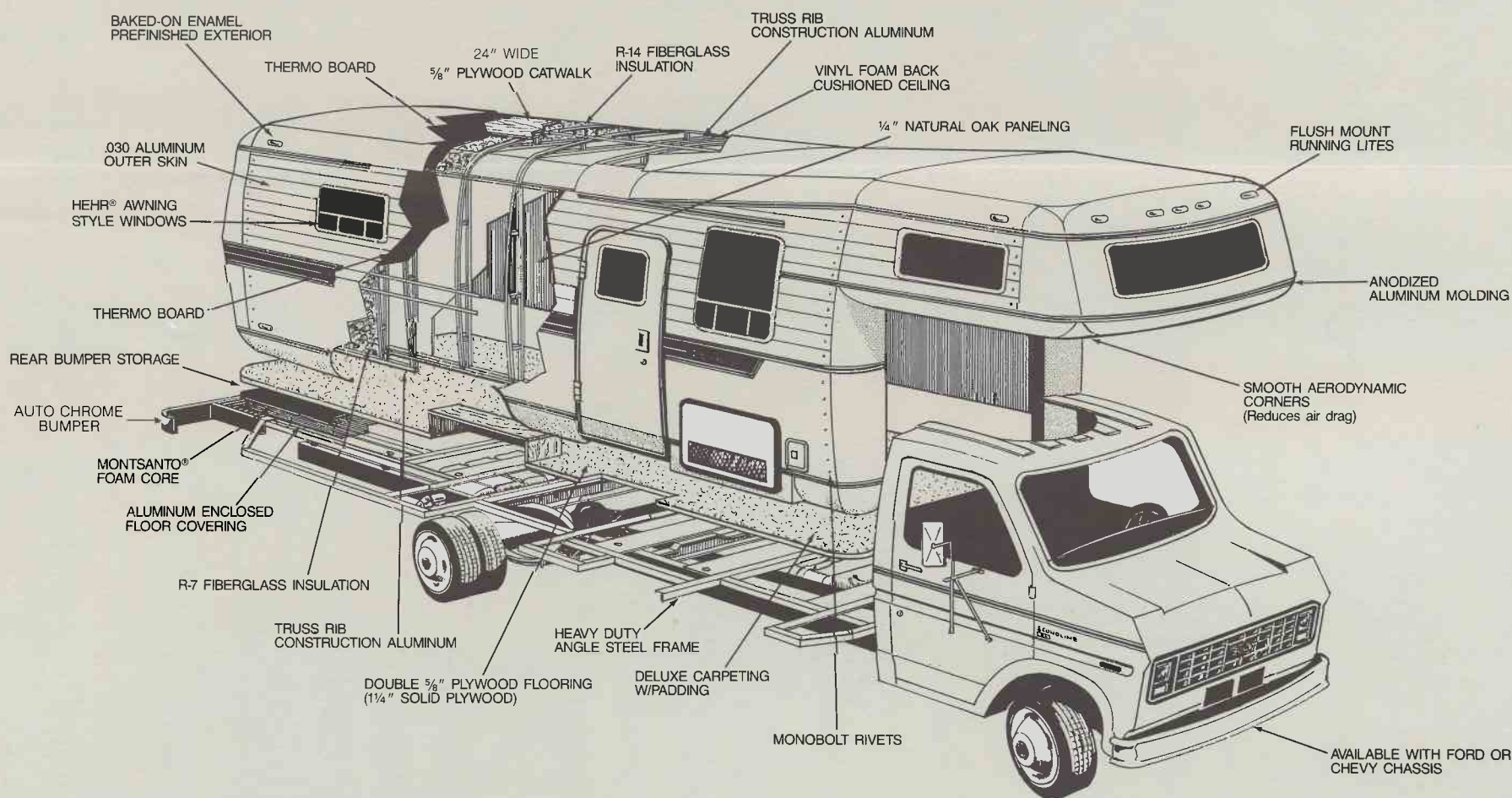

Mini Floor Plans



The 24' PRINCE I - Dry wt. 9,100 lbs. - Overall length 24' 2"

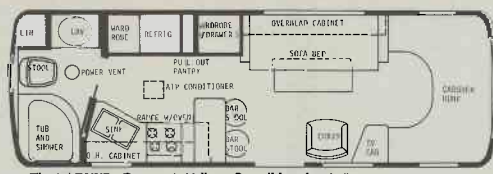

The 27' DUKE - Dry wt. 9,600 lbs. - Overall length 26' 9"

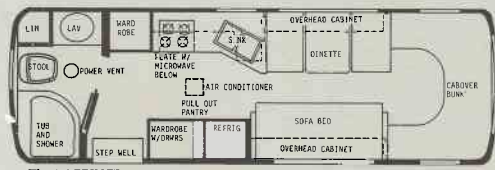

The 27' PRINCE I - Dry wt. 9,600 lbs. - Overall length 26' 9"

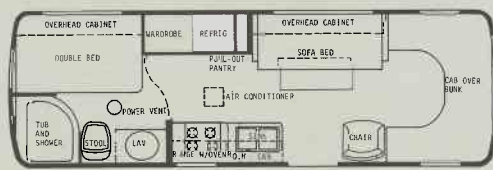

The 27' PRINCESS - Dry wt. 9,600 lbs. - Overall length 26' 9"

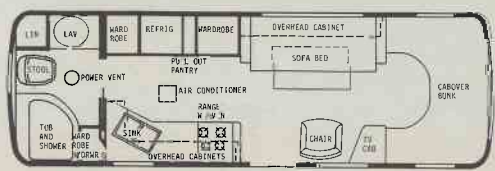

The 27' PRINCE 2 - Dry wt. 9,600 lbs. - Overall length 26' 9"

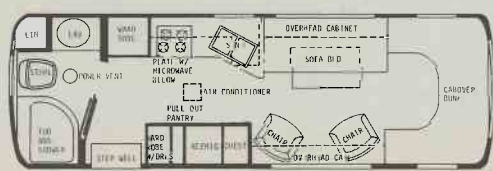

The 27' PRINCE 3 - Dry wt. 9,600 lbs. - Overall length 26' 9"

LONDON AIRE MINI HOME

	24' Prince	27' Princess	27' Prince I	27' Prince II	27' Prince III	27' Duke
Dry Weight	9,100 est.	9,600 lb	9,600 lb.	9,600 lb.	9,600 lb.	9,600 lb.
GVWR - Chevy	10,500 lb	10,500 lb.	10,500 lb.	10,500 lb.	10,500 lb.	10,500 lb.
GVWR - Ford	11,000 lb.	11,000 lb.	11,000 lb.	11,000 lb.	11,000 lb.	11,000 lb.
Fresh Water	30 gal.	30 gal.	30 gal.	30 gal.	30 gal.	30 gal.
Gray Water	25 gal.	25 gal.	36 gal.	36 gal.	36 gal.	36 gal.
Sewage Water	36 gal.	36 gal.	25 gal.	25 gal.	25 gal.	25 gal.
Propane	65 lb.	65 lb.	65 lb.	65 lb.	65 lb.	65 lb.
Water Heater	6 gal.	6 gal.	6 gal.	6 gal.	6 gal.	6 gal.
Dimensions:						
Total Height	9' - 9"	9' - 9"	9' - 9"	9' - 9"	9' - 9"	9' - 9"
Interior Height	78"	78"	78"	78"	78"	78"
Exterior Width	94"	94"	94"	94"	94"	94"
Interior Width	87½"	87½"	87½"	87½"	87½"	87½"
Total Length	24' 2"	26' - 10"	26' - 10"	26' - 10"	26' - 10"	26' - 10"
Mattress to ceiling in Cabover	25"	25"	25"	25"	25"	25"
Exterior Storage	10 cu. ft.	10 cu. ft.	10 cu. ft.	10 cu. ft.	10 cu. ft.	10 cu. ft.
Sleeping Capacity	5	6	5	4	4	4
Bed Sizes - Cabover	58" x 80"	58" x 80"	58" x 80"	58" x 80"	58" x 80"	58" x 80"
Sofabed	41" x 74"	41" x 74"	41" x 74"	41" x 74"	41" x 74"	41" x 74"
Dinette	34" x 72"	—	34" x 72"	—	—	—
Double Bed	—	46" x 74"	—	—	—	—
Wheel Base - Ford	158"	188"	188"	188"	188"	188"
Wheel Base - Chevy	146"	179"	179"	179"	179"	179"

TRAVEL TRAILERS

Exteriors

Some RV manufacturers allow you to choose. At London Aire, we invite you to select from the finest. London Aire is built from the inside out, because what you can't see, or may not be aware of, is just as important as what you can see. For example, your London Aire has a six-inch tubular steel frame, and a glued, double $\frac{5}{8}$ inch plywood floor which is bolted to the frame for solidity. The steel frame includes z-bar cross members for lateral strength. The aluminum superstructure of every London Aire is a truss type rib construction. Exterior sidewalls and roof line are contoured for a better drag coefficient, ease of pulling, less wind resistance,



Select from five interior design color combinations: Plantation Cocoa (L-841), Seafoam Green (L-842), Dusty Rose (L-843), Sapphire Blue (L-844), Champagne Accent (L-845).



Picture yourself relaxing or entertaining in this spacious and luxurious Sapphire Blue living room.

and therefore improved mileage. However, inside walls are of a vertical straight line designed for better space utilization. Coaches are double insulated with fiberglass and thermo board attached to exterior skin metal to provide an effective heat and cold shield. Exterior trim moldings are anodized heat-treated metal commonly used in automotive construction. There is a 25-gauge aluminum underbelly below the floor. Every construction technique has been implemented to make London Aire solid on the road or at home. Finally, your coach rides on world famous Rub-R-Ride (Comfort Core™) suspension.

Interiors

The understated luxury of London Aire interiors is breathtaking. Select from five color schemes, all new for this model year. Beautiful, rich fabrics, elegant draperies, upholstery and carpeting are all color coordinated to make your coach picture perfect and quietly comfortable. Even clean-up is easier because of the new wipe-clean upholstery finishes.



The best awning in the business is one that works easy. Ours does.

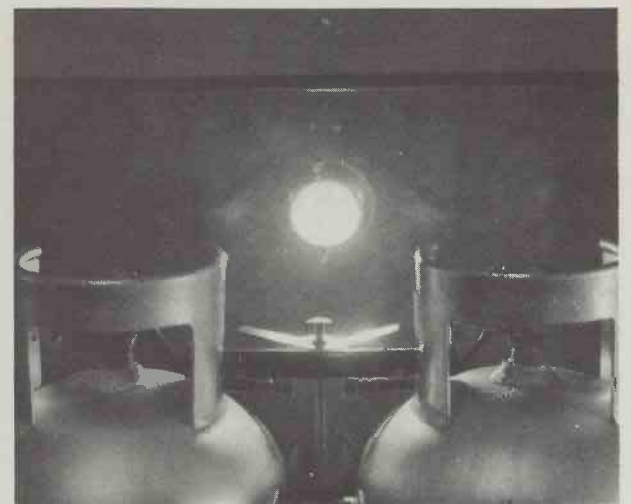

Special chrome-ringed hitch light lets you see anytime, and conveniently lights up propane tanks too. (Aluminum bottles w/gauges).

FIFTH WHEEL TRAILERS



Quality

It's reflected in everything about your London Aire coach. The designer fabrics, the color combinations, the stereo acoustics, the recessed fluorescent overhead lighting and the tinted windows. Rich oak paneling and oak cabinetry were selected for beauty, durability and to provide a warm background which accents whichever color combination you choose.

In addition to your opt. microwave, you'll find a four-burner range with pilot light for top burners and oven. You have plenty of preparation area and pull-out pantry. And the gas/electric refrigerator is larger than those usually found in an RV. In fact, you might like this kitchen better than your kitchen at home!

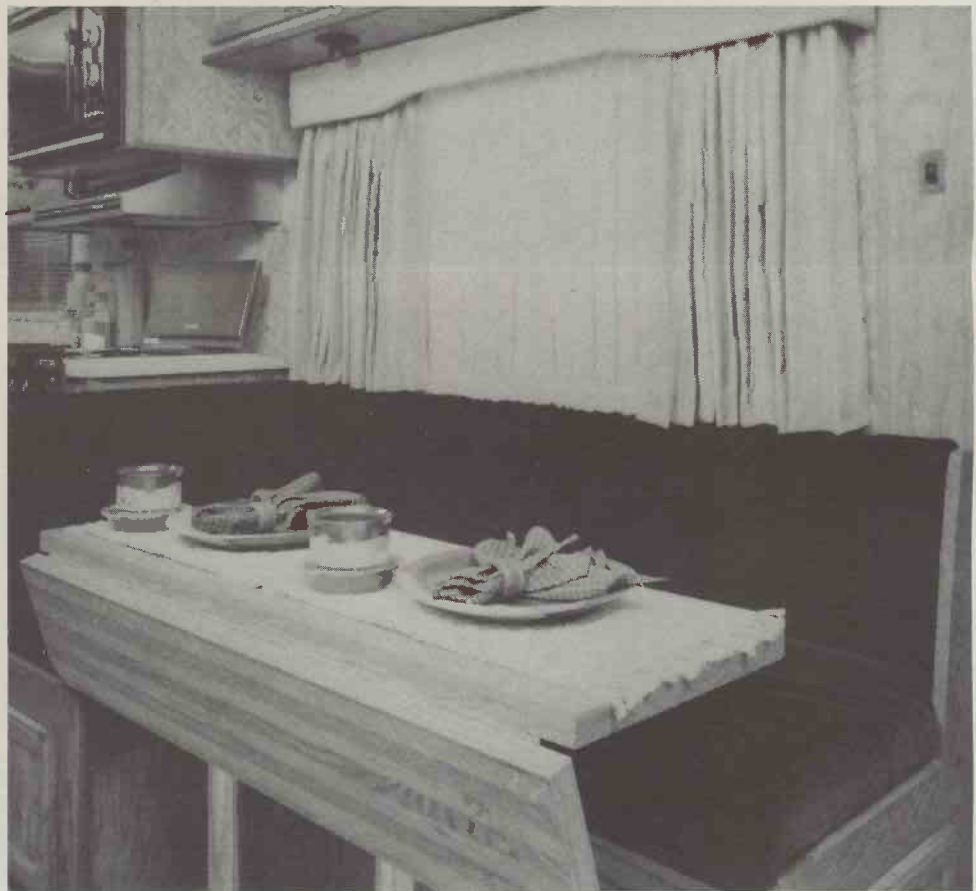

The electric hitch raises or lowers the coach with fingertip control.

Features

Electric hitch with fingertip control. Lighting in areas where you need it the most, including inside wardrobes, at the hitch, generator compartment, drain outlet, under the outside entry step and next to entry door. Plenty of storage area. All exterior storage compartments have key locks and are weather-tight rubber sealed. Aluminum LP gas bottles with gauge and automatic change-over regulator. Outside drain control valve-pull levers are extended for easy access, but enclosed. Outside stabilizer jacks are quick crank-down type, frame mounted for travel and camping convenience. 30,000 BTU electric ignition furnace on all models except 35'-40' fifth wheels which have 34,000 BTU.

The Travel Trailer Floor Plans

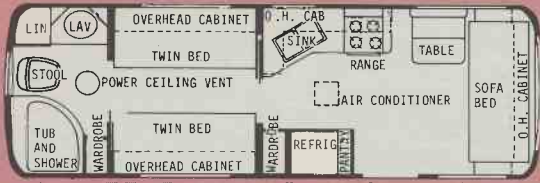

27' Baron T.T. - Dry Wt. 5400 lbs. - Hitch Wt. 700 lbs.
- Overall Length 27' 8"

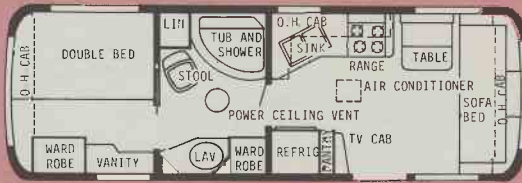

27' Viscount T.T. - Dry Wt. 5400 lbs. - Hitch Wt. 700 lbs.
- Overall Length 27' 8"

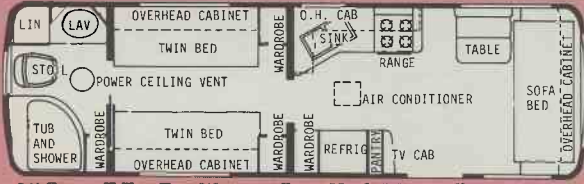

29' Baron T.T. - Dry Wt. 5700 lbs. - Hitch Wt. 800 lbs.
- Overall Length 29' 8"

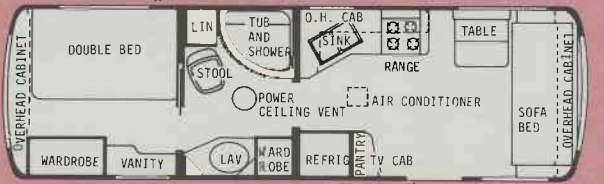

29' Viscount T.T. - Dry Wt. 5700 lbs. - Hitch Wt. 800 lbs.
- Overall Length 29' 8"

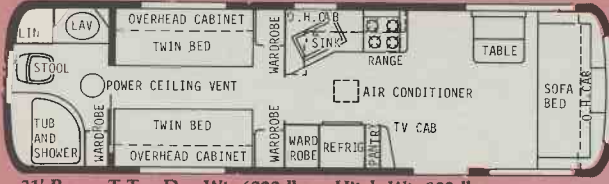

31' Baron T.T. - Dry Wt. 6000 lbs. - Hitch Wt. 800 lbs.
- Overall Length 31' 8"

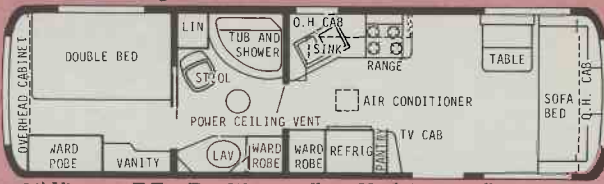

31' Viscount T.T. - Dry Wt. 6000 lbs. - Hitch Wt. 800 lbs.
- Overall Length 31' 8"

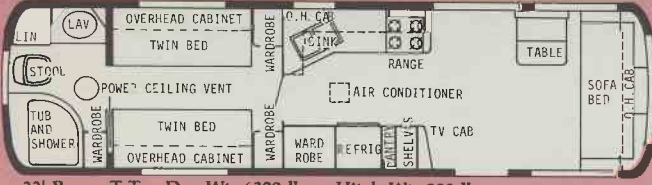

33' Baron T.T. - Dry Wt. 6300 lbs. - Hitch Wt. 900 lbs.
- Overall Length 33' 8"

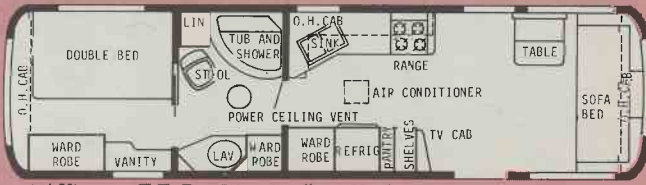

33' Viscount T.T. - Dry Wt. 6300 lbs. - Hitch Wt. 900 lbs.
- Overall Length 33' 8"

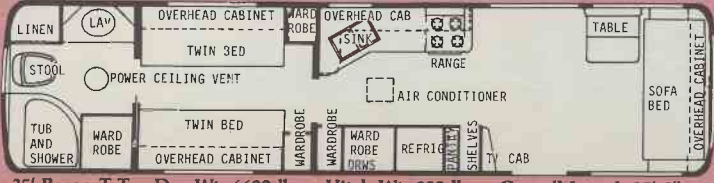

35' Baron T.T. - Dry Wt. 6600 lbs. - Hitch Wt. 900 lbs. - Overall Length 35' 8"

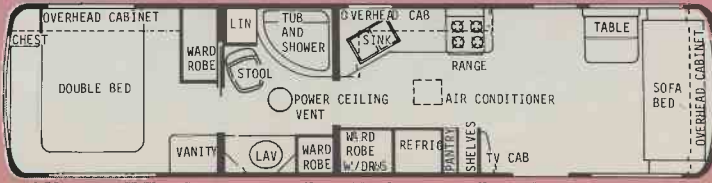

35' Viscount T.T. - Dry Wt. 6600 lbs. - Hitch Wt. 900 lbs. - Overall Length 35' 8"

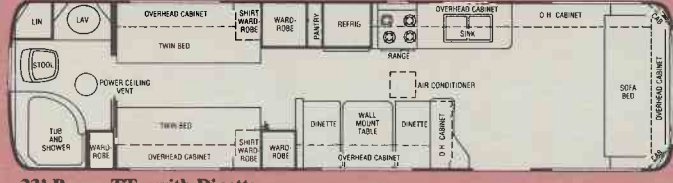

33' Baron TT - with Dinette



33' Viscount TT - with Dinette



35' Baron TT - with Dinette

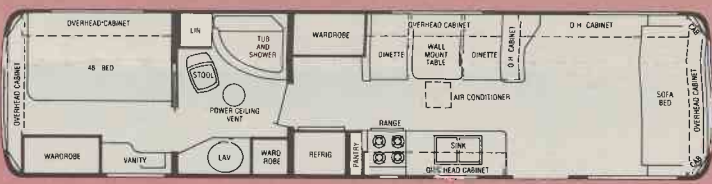

35' Viscount TT - with Dinette

The Fifth Wheel Floor Plans



28' Baron F.W. - Dry Wt. 6900 lbs. - Hitch Wt. 1750 lbs.
- Overall Length 28' 9"

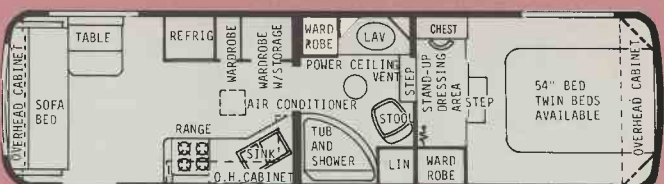

28' Statesman F.W. - Dry Wt. 6900 lbs. - Hitch Wt. 1750 lbs.
- Overall Length 28' 9"

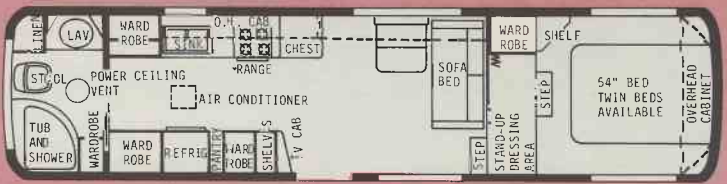

32' Baron F.W. - Dry Wt. 7200 lbs. - Hitch Wt. 1750 lbs. - Overall Length 32' 9"

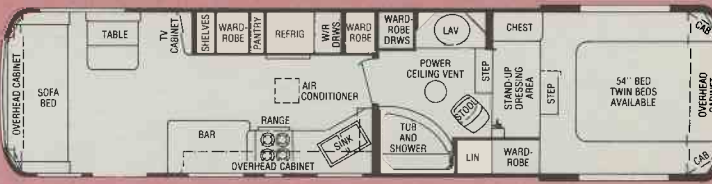

32' Statesman F.W. - Dry Wt. 7200 lbs. - Hitch Wt. 1750 lbs. - Overall Length 32' 9"

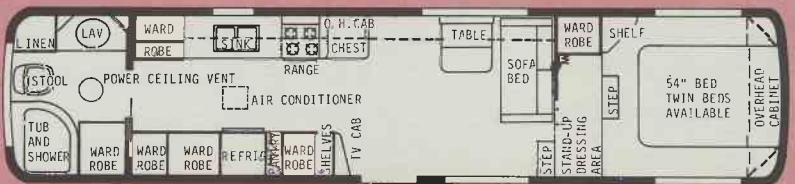

35' Baron F.W. - Dry Wt. 7600 lbs. - Hitch Wt. 1800 lbs. - Overall Length 35' 9"

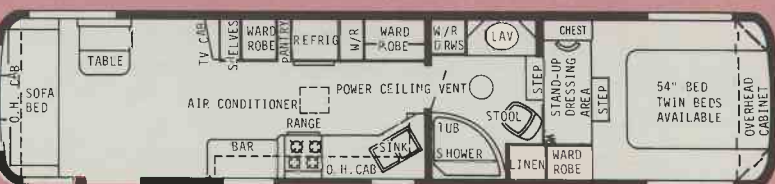

35' Statesman F.W. - Dry Wt. 7600 lbs. - Hitch Wt. 1800 lbs. - Overall Length 35' 9"



40' Baron F.W. - Dry Wt. 8800 lbs. - Hitch Wt. 1750 lbs. - Overall Length 40'



40' Viscount F.W. - Dry Wt. 8800 lbs. - Hitch Wt. 1750 lbs. - Overall Length 40'

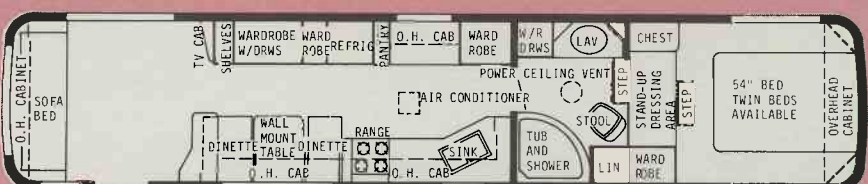

40' Statesman F.W. - Dry Wt. 8800 lbs. - Hitch Wt. 1750 lbs. - Overall Length 40'

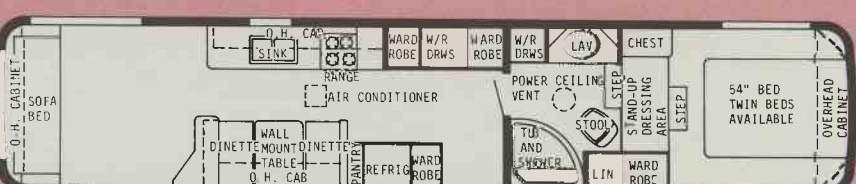

40' Kingsman F.W. - Dry Wt. 8800 lbs. - Hitch Wt. 1750 lbs. - Overall Length 40'

Type of Construction

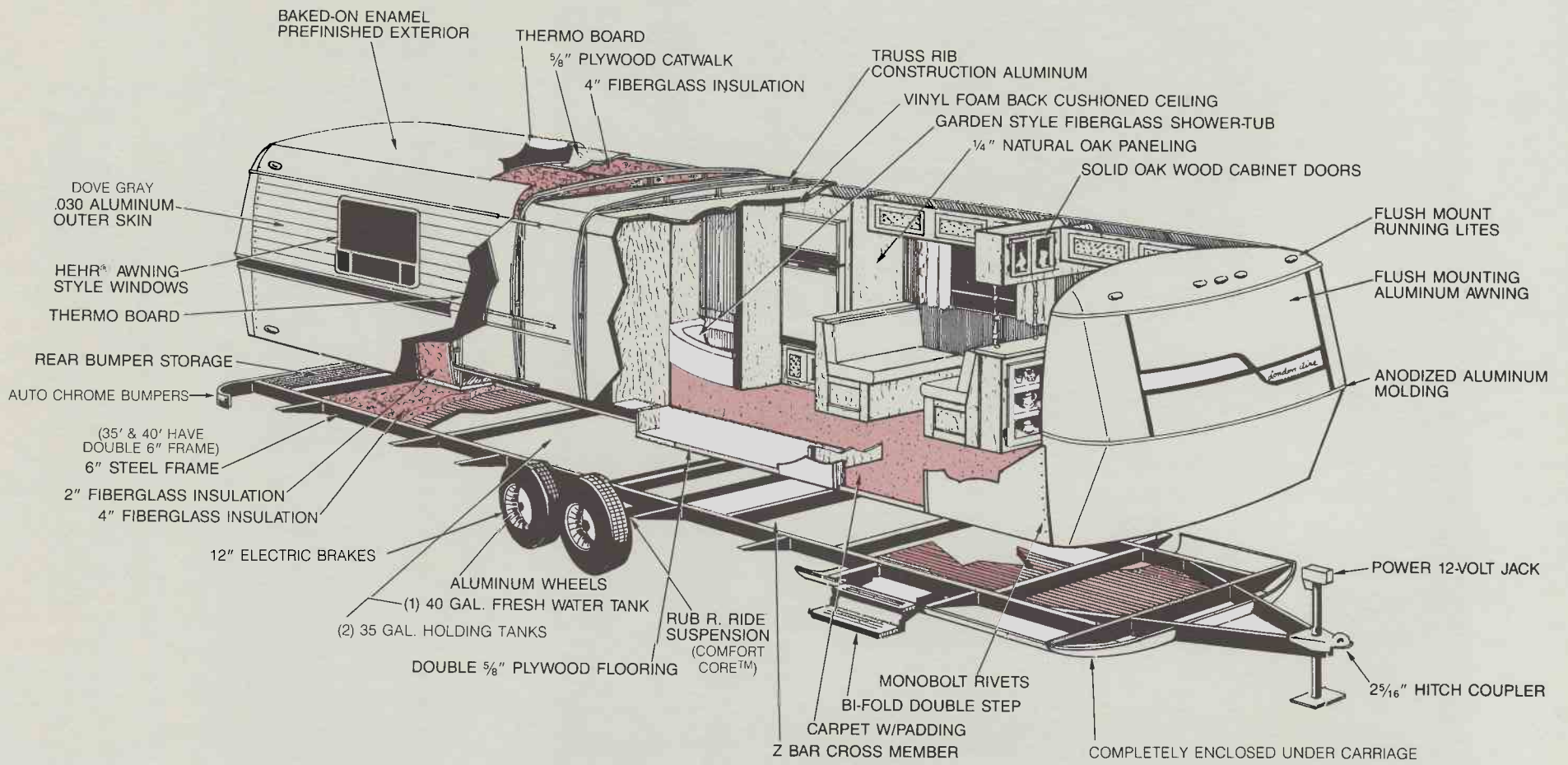

Specifications

London Aire	27' VISCOUNT	27' BARON	29' VISCOUNT	29' BARON	31' VISCOUNT	31' BARON	33' VISCOUNT	33' BARON	33' BARON W/DINETTE	33' VISCOUNT W/DINETTE	35' BARON W/DINETTE	35' VISCOUNT W/DINETTE	35' VISCOUNT	35' BARON	528 STATESMAN	528 BARON	532 STATESMAN	532 BARON	535 STATESMAN	535 BARON	540 STATESMAN	540 BARON	540 VISCOUNT	540 KINGSMAN
KITCHEN																								
Oven range with bi-fold cover	Std.	Std.	Std.	Std.	Std.	Std.	Std.	Std.	Std.	Std.	Std.	Std.	Std.	Std.	Std.	Std.	Std.	Std.	Std.	Std.	Std.	Std.	Std.	Std.
Double stainless steel sink	Std.	Std.	Std.	Std.	Std.	Std.	Std.	Std.	Std.	Std.	Std.	Std.	Std.	Std.	Std.	Std.	Std.	Std.	Std.	Std.	Std.	Std.	Std.	Std.
Gas electric refrigerator	Std.	Std.	Std.	Std.	Std.	Std.	Std.	Std.	Std.	Std.	Std.	Std.	Std.	Std.	Std.	Std.	Std.	Std.	Std.	Std.	Std.	Std.	Std.	Std.
Pull-out pantry	Std.	Std.	Std.	Std.	Std.	Std.	Std.	Std.	Std.	Std.	Std.	Std.	Std.	Std.	Std.	Std.	Std.	Std.	Std.	Std.	Std.	Std.	Std.	Std.
Oak cabinets	Std.	Std.	Std.	Std.	Std.	Std.	Std.	Std.	Std.	Std.	Std.	Std.	Std.	Std.	Std.	Std.	Std.	Std.	Std.	Std.	Std.	Std.	Std.	Std.
Microwave oven	Opt.	Opt.	Opt.	Opt.	Opt.	Opt.	Opt.	Opt.	Opt.	Opt.	Opt.	Opt.	Opt.	Opt.	Opt.	Opt.	Opt.	Opt.	Opt.	Opt.	Opt.	Opt.	Opt.	Opt.
Central vacuum system	Opt.	Opt.	Opt.	Opt.	Opt.	Opt.	Opt.	Opt.	Opt.	Opt.	Opt.	Opt.	Opt.	Opt.	Opt.	Opt.	Opt.	Opt.	Opt.	Opt.	Opt.	Opt.	Opt.	Opt.
Garbage disposal	Opt.	Opt.	Opt.	Opt.	Opt.	Opt.	Opt.	Opt.	Opt.	Opt.	Opt.	Opt.	Opt.	Opt.	Opt.	Opt.	Opt.	Opt.	Opt.	Opt.	Opt.	Opt.	Opt.	Opt.
LIVING ROOM																								
TV cabinet/Shelf	Std.	Std.	Std.	Std.	Std.	Std.	Std.	Std.	Std.	Std.	Std.	Std.	Std.	Std.	Std.	Std.	Std.	Std.	Std.	Std.	Std.	Std.	Std.	Std.
Sofa bed	Std.	Std.	Std.	Std.	Std.	Std.	Std.	Std.	Std.	Std.	Std.	Std.	Std.	Std.	Std.	Std.	Std.	Std.	Std.	Std.	Std.	Std.	Std.	Std.
AM-FM stereo radio	Std.	Std.	Std.	Std.	Std.	Std.	Std.	Std.	Std.	Std.	Std.	Std.	Std.	Std.	Std.	Std.	Std.	Std.	Std.	Std.	Std.	Std.	Std.	Std.
Rocker chair	Opt.	Opt.	Opt.	Opt.	Opt.	Opt.	Opt.	Opt.	Opt.	Opt.	Opt.	Opt.	Opt.	Opt.	Opt.	Opt.	Opt.	Opt.	Opt.	Opt.	Opt.	Opt.	Opt.	Opt.
Pedestal chair	Opt.	Opt.	Opt.	Opt.	Opt.	Opt.	Opt.	Opt.	Opt.	Opt.	Opt.	Opt.	Opt.	Opt.	Opt.	Opt.	Opt.	Opt.	Opt.	Opt.	Opt.	Opt.	Opt.	Opt.
BEDROOM																								
6" mattress	Std.	Std.	Std.	Std.	Std.	Std.	Std.	Std.	Std.	Std.	Std.	Std.	Std.	Std.	Std.	Std.	Std.	Std.	Std.	Std.	Std.	Std.	Std.	Std.
Automatic lighted wardrobes	Std.	Std.	Std.	Std.	Std.	Std.	Std.	Std.	Std.	Std.	Std.	Std.	Std.	Std.	Std.	Std.	Std.	Std.	Std.	Std.	Std.	Std.	Std.	Std.
Double bed	Std.	NA	Std.	NA	Std.	NA	Std.	NA	NA	Std.	NA	Std.	NA	Std.	NA	Std.	NA	Std.	NA	Std.	NA	Std.	NA	Std.
Twin beds	Opt.	Std.	Opt.	Std.	Opt.	Std.	Opt.	Std.	Opt.	Std.	Opt.	Std.	Opt.	Std.	Opt.	Std.	Opt.	Std.	Opt.	Std.	Opt.	Std.	Opt.	Std.
BATH																								
Adjustable height shower head	Std.	Std.	Std.	Std.	Std.	Std.	Std.	Std.	Std.	Std.	Std.	Std.	Std.	Std.	Std.	Std.	Std.	Std.	Std.	Std.	Std.	Std.	Std.	Std.
Power vent	Std.	Std.	Std.	Std.	Std.	Std.	Std.	Std.	Std.	Std.	Std.	Std.	Std.	Std.	Std.	Std.	Std.	Std.	Std.	Std.	Std.	Std.	Std.	Std.
36" x 40" fiberglass shower	Std.	Std.	Std.	Std.	Std.	Std.	Std.	Std.	Std.	Std.	Std.	Std.	Std.	Std.	Std.	Std.	Std.	Std.	Std.	Std.	Std.	Std.	Std.	Std.
Medicine cabinet, 3 mirrors	Std.	Std.	Std.	Std.	Std.	Std.	Std.	Std.	Std.	Std.	Std.	Std.	Std.	Std.	Std.	Std.	Std.	Std.	Std.	Std.	Std.	Std.	Std.	Std.
ADDITIONAL COMFORTS																								
Tinted safety windows	Std.	Std.	Std.	Std.	Std.	Std.	Std.	Std.	Std.	Std.	Std.	Std.	Std.	Std.	Std.	Std.	Std.	Std.	Std.	Std.	Std.	Std.	Std.	Std.
High performance water heater	Std.	Std.	Std.	Std.	Std.	Std.	Std.	Std.	Std.	Std.	Std.	Std.	Std.	Std.	Std.	Std.	Std.	Std.	Std.	Std.	Std.	Std.	Std.	Std.
12V demand water supply	Std.	Std.	Std.	Std.	Std.	Std.	Std.	Std.	Std.	Std.	Std.	Std.	Std.	Std.	Std.	Std.	Std.	Std.	Std.	Std.	Std.	Std.	Std.	Std.
Roof R - 14 and R - 17 wall insulation	Std.	Std.	Std.	Std.	Std.	Std.	Std.	Std.	Std.	Std.	Std.	Std.	Std.	Std.	Std.	Std.	Std.	Std.	Std.	Std.	Std.	Std.	Std.	Std.
Generator	NA	NA	NA	NA	NA	NA	NA	NA	NA	NA	NA	NA	NA	Opt.	Opt.	Opt.	Opt.	Opt.	Opt.	Opt.	Opt.	Opt.	Opt.	Opt.
Intercom system	Opt.	Opt.	Opt.	Opt.	Opt.	Opt.	Opt.	Opt.	Opt.	Opt.	Opt.	Opt.	Opt.	Opt.	Opt.	Opt.	Opt.	Opt.	Opt.	Opt.	Opt.	Opt.	Opt.	Opt.
Door bell	Opt.	Opt.	Opt.	Opt.	Opt.	Opt.	Opt.	Opt.	Opt.	Opt.	Opt.	Opt.	Opt.	Opt.	Opt.	Opt.	Opt.	Opt.	Opt.	Opt.	Opt.	Opt.	Opt.	Opt.
Furnace (BTUs) ducted-forced air	30M	30M	30M	30M	30M	30M	30M	30M	30M	30M	34M	34M	34M	34M	30M	30M	30M	30M	34M	34M	34M	34M	34M	34M
34,000 BTU furnace	Opt.	Opt.	Opt.	Opt.	Opt.	Opt.	Opt.	Opt.	Opt.	Std.	Std.	Std.	Std.	Opt.	Opt.	Opt.	Opt.	Std.	Std.	Std.	Std.	Std.	Std.	
Hi-Lo table	Opt.	Opt.	Opt.	Opt.	Opt.	Opt.	Opt.	Opt.	Opt.	Opt.	Opt.	Opt.	Opt.	Opt.	Opt.	Opt.	Opt.	Opt.	Opt.	Opt.	Opt.	Opt.	Opt.	Opt.
1/4" paneling	Std.	Std.	Std.	Std.	Std.	Std.	Std.	Std.	Std.	Std.	Std.	Std.	Std.	Std.	Std.	Std.	Std.	Std.	Std.	Std.	Std.	Std.	Std.	Std.
Padded vinyl ceiling	Std.	Std.	Std.	Std.	Std.	Std.	Std.	Std.	Std.	Std.	Std.	Std.	Std.	Std.	Std.	Std.	Std.	Std.	Std.	Std.	Std.	Std.	Std.	Std.
Cushioned vinyl floor tile	Opt.	Opt.	Opt.	Opt.	Opt.	Opt.	Opt.	Opt.	Opt.	Opt.	Opt.	Opt.	Opt.	Opt.	Opt.	Opt.	Opt.	Opt.	Opt.	Opt.	Opt.	Opt.	Opt.	Opt.
Sculptured carpet and pad	Std.	Std.	Std.	Std.	Std.	Std.	Std.	Std.	Std.	Std.	Std.	Std.	Std.	Std.	Std.	Std.	Std.	Std.	Std.	Std.	Std.	Std.	Std.	Std.
EXTERIOR																								
Spare tire and wheel	Opt.	Opt.	Opt.	Opt.	Opt.	Opt.	Opt.	Opt.	Opt.	Opt.	Opt.	Opt.	Opt.	Opt.	Opt.	Opt.	Opt.	Opt.	Opt.	Opt.	Opt.	Opt.	Opt.	Opt.
LP gas bottles with gauges	Std.	Std.	Std.	Std.	Std.	Std.	Std.	Std.	Std.	Std.	Std.	Std.	Std.	Std.	Std.	Std.	Std.	Std.	Std.	Std.	Std.	Std.	Std.	Std.
Front power jacks	Std.	Std.	Std.	Std.	Std.	Std.	Std.	Std.	Std.	Std.	Std.	Std.	Std.	Opt.	Opt.	Opt.	Opt.	Opt.	Opt.	Opt.	Opt.	Opt.	Opt.	Opt.
Chrome auto-style rear bumper	Std.	Std.	Std.	Std.	Std.	Std.	Std.	Std.	Std.	Std.	Std.	Std.	Std.	Std.	Std.	Std.	Std.	Std.	Std.	Std.	Std.	Std.	Std.	Std.
Zip-Dee side awning	Opt.	Opt.	Opt.	Opt.	Opt.	Opt.	Opt.	Opt.	Opt.	Opt.	Opt.	Opt.	Opt.	Opt.	Opt.	Opt.	Opt.	Opt.	Opt.	Opt.	Opt.	Opt.	Opt.	Opt.
Aluminum wheels	Std.	Std.	Std.	Std.	Std.	Std.	Std.	Std.	Std.	Std.	Std.	Std.	Std.	Std.	Std.	Std.	Std.	Std.	Std.	Std.	Std.	Std.	Std.	Std.
13,500 roof air conditioner	Std.	Std.	Std.	Std.	Std.	Std.	Std.	Std.	Std.	Std.	Std.	Std.	Std.	Std.	Std.	Std.	Std.	Std.	Std.	Std.	Std.	Std.	Std.	Std.
Heat in roof air conditioner	Opt.	Opt.	Opt.	Opt.	Opt.	Opt.	Opt.	Opt.	Opt.	Opt.	Opt.	Opt.	Opt.	Opt.	Opt.	Opt.	Opt.	Opt.	Opt.	Opt.	Opt.	Opt.	Opt.	Opt.
Front rear awnings flush mounted	Std.	Std.	Std.	Std.	Std.	Std.	Std.	Std.	Std.	Std.	Std.	Std.	Std.	Fr NA	Fr NA	Fr NA	Fr NA	Fr NA	Fr NA	Fr NA	Fr NA	Fr NA	Fr NA	Fr NA
Power TV antenna	Std.	Std.	Std.	Std.	Std.	Std.	Std.	Std.	Std.	Std.	Std.	Std.	Std.	Std.	Std.	Std.	Std.	Std.	Std.	Std.	Std.	Std.	Std.	Std.

Some features are optional. Features and specifications are subject to change without prior notice.

All weights shown are approximate.

All London Aire features and options are not included. Your dealer has a complete list.

Each London Aire meets all requirements of the RVIA, Recreational Vehicle Industry Association; the ANSI, American National Standards Institute; and all state and federal codes.

Some features shown in photographs are optional. Features and specifications are subject to change without prior notice.

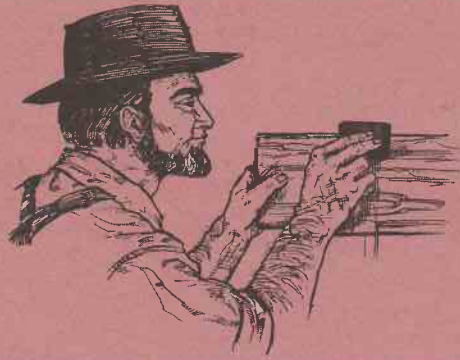

London Aire[®]

**NEWMAR QUALITY IS YOUR REASON TO BUY...
HERE ARE TWENTY REASONS WHY YOU WILL VALUE YOUR DECISION.**

1. Six-inch rugged tubular steel frame with cross members and outriggers.
2. All four wheels equipped with 12" electric brake axles.
3. Rust-resistant, insulated, galvanized wheel wells.
4. Double 5/8" plywood floor. (1 1/4" of solid wood floor.)
5. Completely enclosed, fully insulated, wrap-around aluminum underbelly.
6. Large dual holding tanks.
7. Large fresh water tank with demand water system and standard city water hook up.
8. A.B.S. drain, waste, and vent lines for leakproof joints.
9. All copper "code" approved electrical wiring.
10. The super structure of the LONDON AIRE is a truss type of all aluminum sidewall and roof rib—straight inner wall and contour outer perimeter.
11. Double insulated: Fully insulated with fiberglass plus completely enclosed and sealed with Thermo Board.
12. Smooth aerodynamically designed radius exterior corners.
13. Single seam, heat deflecting dove gray aluminum roof.
14. .030 dove gray aluminum exterior metal.
15. Full opening type, solar efficient, radius corner, Hehr jalousie style windows.
16. High quality 1/4" oak paneling w/solid oak wood cabinet fronts.
17. Cabinets and drawers are glued and screwed for maximum strength and durability.
18. Brand new decor package includes following designer color-coordinated selections: Plantation Cocoa (L-841), Seafoam Green (L-842), Dusty Rose (L-843), Sapphire Blue (L-844), Champagne Accent (L-845).
19. Quality name brand fixtures and appliances used throughout.
20. Built to RVIA approved standards and codes for your complete satisfaction and comfort.