

NEW MAR

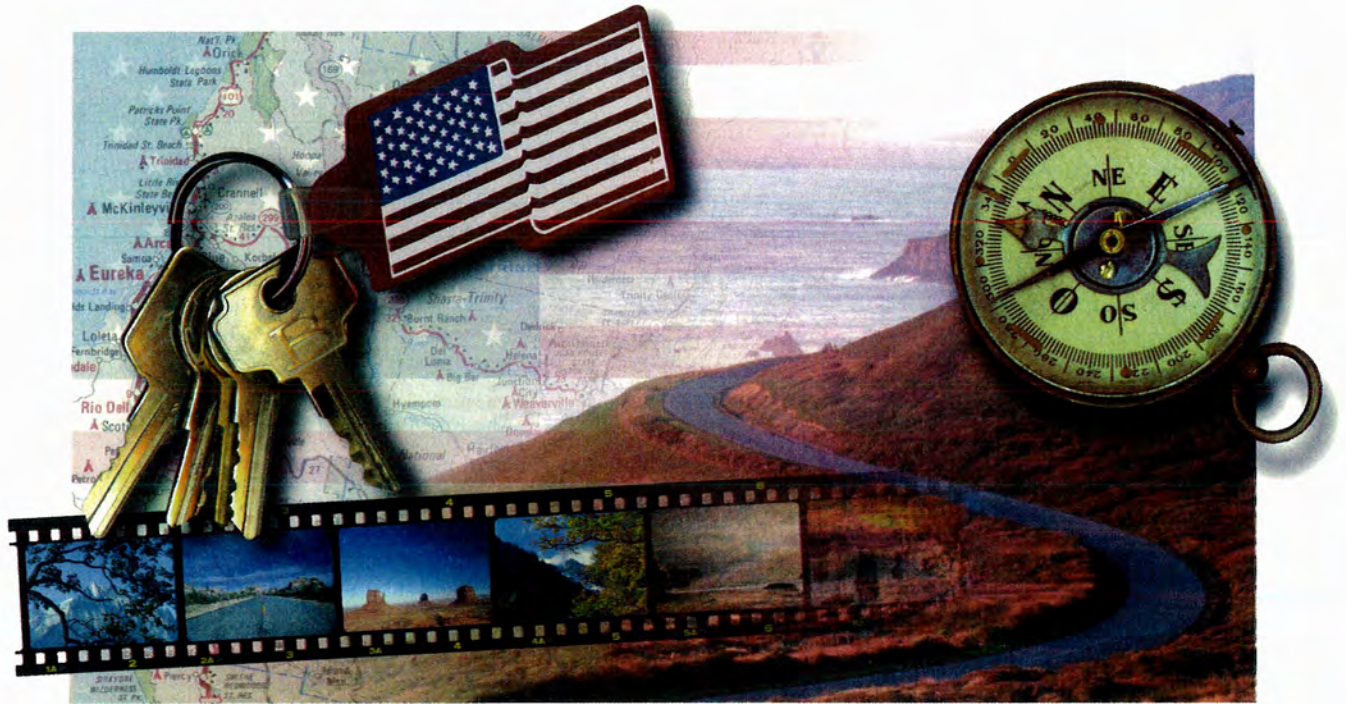

OWNER'S GUIDE

1997 Mountain Aire

DIESEL PUSHER MOTORHOME

NEWMAR CORPORATION OWNER'S GUIDE

Table of Contents

Chapter 1	General Information
Chapter 2	Driving & Safety Precautions
Chapter 3	Air Conditioning & Heating
Chapter 4	Appliances & Accessories
Chapter 5	Cabinets & Furniture
Chapter 6	Chassis Features
Chapter 7	Electrical Features
Chapter 8	Slide Out Features
Chapter 9	Exterior Features
Chapter 10	Interior Features
Chapter 11	Plumbing & Bath Features
Chapter 12	Construction Features
Chapter 13	Windows, Awnings, Vents, & Doors
Chapter 14	Routine Maintenance
Chapter 15	Charts & Diagrams



Welcome to the exciting world of RV traveling and the growing family of recreational vehicle owners.

Congratulations on your purchase of a Newmar product. We sincerely thank you for choosing Newmar as your recreational vehicle. We trust this guide will help you to better understand and enjoy your new RV. We hope that you will enjoy many miles of traveling. Your new vehicle was built with care using today's technology and old world craftsmanship. We, at Newmar, strive to build vehicles that are safe, dependable, and comfortable to provide years of carefree, pleasant traveling.

This Owner's Guide, along with the Video Guide, should be kept in your vehicle for quick reference. Take time to get acquainted with your unit and how it operates. Carefully read both the instructions in this guide and the booklets supplied by the component manufacturers for important operation, safety, and maintenance information. Your dealer should be consulted should you have any questions. If your dealer is unable to answer the questions to your satisfaction, he will refer you to our staff for help. Our customers are extremely important to us, and we will make every effort necessary to ensure your satisfaction.

Again, thank you and welcome to our Newmar family.

Newmar Corporation

This guide, along with the Video Owner's Guide, has been provided by Newmar Corporation solely for the purpose of providing instructions about the operation and maintenance of this vehicle and its components. Nothing in this manual creates any warranty, either express or implied. The only warranty offered by Newmar Corporation is set forth in the written limited warranty that applies to this vehicle.

Instructions are included in this manual for operating some of the components that are standard on this vehicle. Instructions are also given for components that are options and may not appear on all vehicles. For more detailed information on components refer to the individual manufacturer's operating instructions contained in the Owner's Information Package.

The limited warranties issued by component manufacturers require periodic service and maintenance, and the owner's failure to provide this service and/or maintenance will result in the loss of warranty coverage. The owner should review the Newmar Corporation limited warranty and other manufacturers' limited warranties of all components applicable to this vehicle. To activate the warranties on the components within your Newmar recreational vehicle, be sure to file the appropriate registration card with the component manufacturer as described with the individual instruction booklet.

Newmar Corporation has compiled the most current information available at the time of publication. If the components in your unit vary significantly from what is described within this manual, then consult the instructions provided by the component manufacturer found in the Owner's Package.

Throughout this guide, reference is made to the following terms: Warning, Caution, and Important. These terms indicate important information that must be understood and followed. The definitions of these terms are:

WARNING

Emphasizes an area in which personal injury or even death could result from failure to follow instructions properly. Mechanical damage may also occur.

CAUTION

Failure to observe a caution can cause damage to the equipment or unit. Personal injury is unlikely.

IMPORTANT

Provides additional information to make a step easier or clearer.

CHAPTER 1

GENERAL INFORMATION

Table of Contents

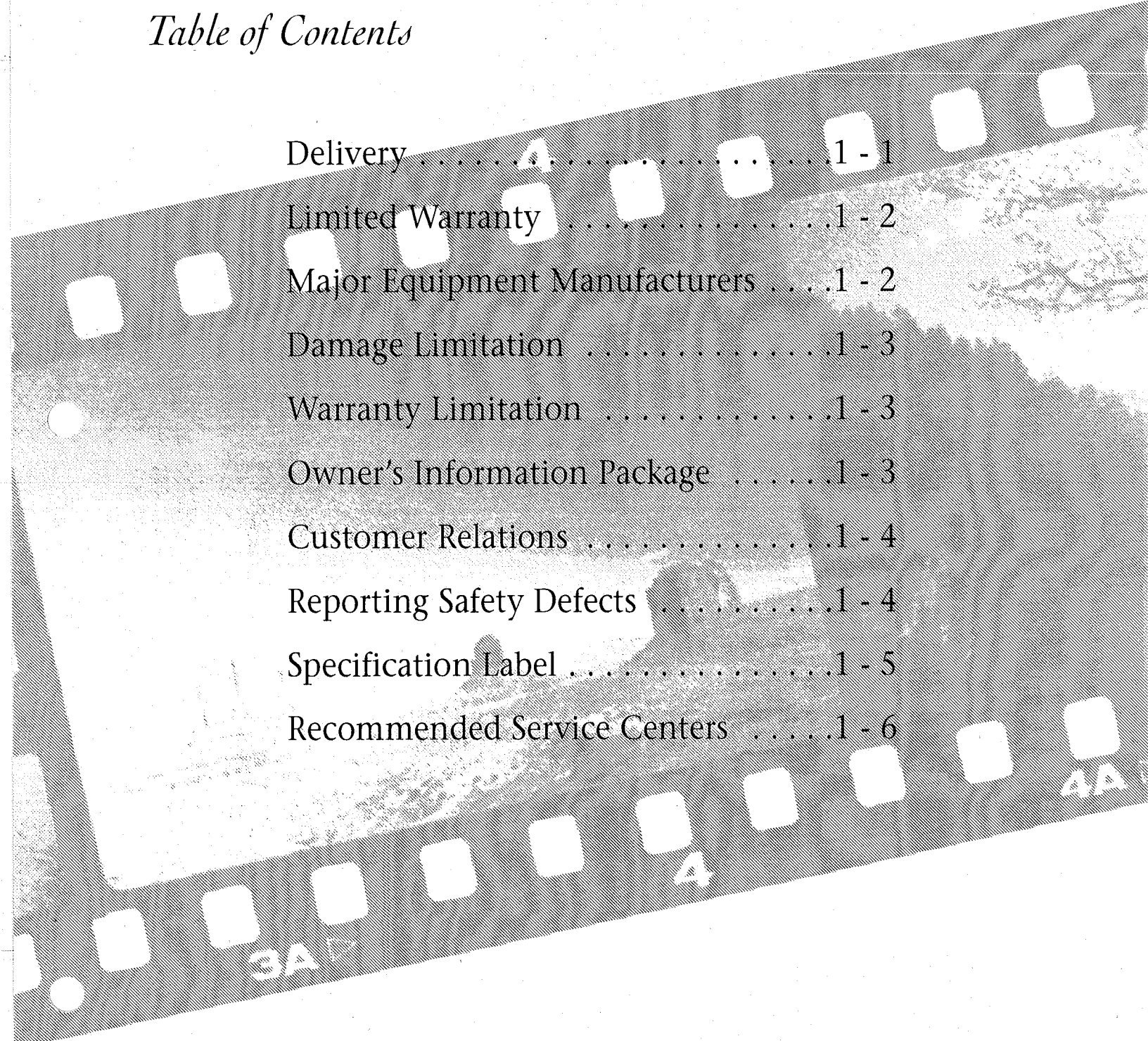

Delivery	1 - 1
Limited Warranty	1 - 2
Major Equipment Manufacturers	1 - 2
Damage Limitation	1 - 3
Warranty Limitation	1 - 3
Owner's Information Package	1 - 3
Customer Relations	1 - 4
Reporting Safety Defects	1 - 4
Specification Label	1 - 5
Recommended Service Centers	1 - 6



DELIVERY

Throughout the manufacturing process your vehicle has been inspected by our qualified technicians. However, our final inspection at the factory is not to be the last one. The pre-delivery inspection and systems check your dealer performs are the final inspections done to the unit prior to your receiving your new coach. Your dealer is also available to assist you in understanding the limited warranties and completing any necessary forms to activate the warranties for the various appliances and accessories installed in your unit.

Dealer Responsibilities

1. A pre-delivery inspection and systems check. Thoroughly inspecting the vehicle and the operation of the factory installed components.
2. A customer walk-through. This is done to familiarize the customer with the vehicle, its systems and components, and their operation.
3. Delivery of the Owner's Information Package. This package contains the warranty cards and registrations for the vehicle and factory installed components that carry a separate warranty. The detailed operating and maintenance instructions on these components are also included in this package.
4. Assisting the customer in completing the component registration forms, at the customer's request. To avoid loss of warranty coverage, the dealer should review the limited warranty provisions with the customer stressing the importance of filing warranty cards and registrations to the component's manufacturers within the prescribed time limit.
5. Providing the customer with information regarding warranty and non-warranty work on the vehicle and its separately warranted components whether the customer is in or out of the area.

Customer Responsibilities

The customer is responsible for regular and proper maintenance of the vehicle. Properly maintaining your vehicle will prevent conditions arising from neglect that are not covered by your Newmar limited warranty. The maintenance guidelines in this manual and any other applicable manual should be followed. It is your responsibility and obligation to return the vehicle to an authorized dealer for repairs and service.

To assist you in avoiding problems with your vehicle, we recommend you do the following:

- a. Read the warranty. Go over it thoroughly with your dealer.
- b. Inspect the vehicle. Do not accept delivery until you have gone through the unit with the dealer. Newmar has provided a check list to be used during retail delivery. Check each item on the list and make sure he does the same. Do not sign this checklist until you have done this.
- c. Ask questions about anything that you do not understand concerning your recreational vehicle.
- d. When taking delivery, set an appointment for adjustments. This appointment should be approximately two (2) weeks after you accept delivery.

RECREATIONAL VEHICLE LIMITED WARRANTY

Some of the items installed on your unit are warranted by the original manufacturer. Newmar does not warrant these items. These items include batteries, light bulbs, microwaves, televisions, washer, dryers, air conditioners, satellite dish systems, security systems, CB radios, VCR's, tires, and any automotive chassis components. Below you will find a list of manufacturers who can help you with these components.

Major Equipment Manufacturers

A & E Awnings	.800-544-4881
Acme Air Conditioning	.800-552-2263
B & W Magnetek (Converter)	.219-356-7102
Carefree Awnings	.800-621-2617
Chevrolet Customer Service	.800-222-1020
Dexter Axle	.219-295-1900
Diesel Equipment (Wiper System)	.910-373-8331
Dometic, Duo Therm	.800-544-4881
Evans Dash Air Conditioning	.800-354-7088
Fantastic Vents	.800-521-0298
Flexsteel	.319-556-7730
Ford Motor Company	.800-444-3311
Freightliner Chassis	.414-235-1726
Goodyear Tires	.800-227-1999
Granning Air Suspension	.800-255-7824
Hartco Flooring	.615-569-8888
Heart Interface	.800-446-6180
HWH Leveling Jacks	.800-321-3494
Kohler Generators	.414-565-3381
Kwikke Products (Step)	.800-736-9961
Larson Electronics (Monitor Panel)	.714-738-3551
Magnavox Appliances	.800-531-0039
MasterCraft Chairs & Sofas	.800-522-5652
Michelin Tires	.800-847-8475
Moen Faucets	.800-321-8809
Mor/Ryde Suspension	.219-293-1581
MTI Industries	.708-487-4940
Newmar Corporation	.800-731-8300
Norcold Refrigeration	.800-543-1219
Onan Generators	.800-888-6626
Panasonic Radio & Microwaves	.800-447-4700
Power Tech Generators	.800-760-0027
Sealand Toilets	.800-321-9886
Sears Washer & Dryer	.800-359-2000
Sharp	.800-237-4277
Spartan Chassis	.800-543-4277
Splendide Washer/Dryer	.504-229-4922
Suburban Furnace	.800-659-2138
Thermoil Batteries	.800-697-9505
Thetford Toilet	.800-521-3032
Michigan Residents	.313-769-6000
Todd Engineering	.219-293-8633
Trekmate Security Systems	.619-941-3444
U-Line Ice Maker	.800-779-2547
Wedgewood Range (Atwood)	.615-643-4556
Winegard Antenna Systems	.800-288-8094

DAMAGE LIMITATION

Newmar Corporation will not be responsible for any incidental or consequential damages, including (but not limited to) loss of vehicle use, loss of time, inconvenience, expenses for travel, lodging, transportation charges, loss or damage to personal property or loss of income.

Please note, however, that some states do not allow the exclusion or the limitation of incidental or consequential damages, so the above limitation may not apply to you.

Oral and Implied Warranty Limitation

Implied warranties such as any warranty of merchantability or fitness for a particular purpose covers only the original purchaser. Coverage terminates 365 days from the date of purchase or on the date the original purchaser sells or transfers his interest in the recreational vehicle to a subsequent owner.

It is the intent of Newmar Corporation to comply with the Magnuson-Moss Warranty Act and the Federal Trade Commission's prescribed rulings. Newmar Corporation is not liable for, and will not recognize, any warranty other than the implied warranties under state law and the written warranty contained in this document. In other words, no other warranty, written or oral, is given by Newmar Corporation.

Please note, however, some states do not allow limitations on how long an implied warranty lasts, so the above limitation may not apply to you.

Transfer Limitation

This warranty is not assignable or transferable.

Legal Rights

This warranty gives you specific legal rights, and you may also have other rights that may vary from state to state.

Reserved Right to Change

Newmar Corporation reserves the right to make changes or improvements in vehicles it produces in the future, without imposing on itself any duty to install the same improvements in vehicles it has previously manufactured.

Owner's Information Package

Included in this package are valuable documents about your vehicle and its components and systems. The Newmar Owner's Guide does not cover every possible detail of equipment, standard and/or option, installed on or in your vehicle. Consulting the booklets and instruction manuals in this package will help you safely operate, maintain, and troubleshoot these items.

Read all of the information and understand the safety and operating instructions included in the Owner's Information Package. To assure full warranty coverage, it is essential that all maintenance instructions are followed.



CUSTOMER RELATIONS

We, at Newmar Corporation, are concerned about our customer's satisfaction. Therefore, if you discover a defect or a problem, please follow these instructions:

Upon discovery of a defect, you should notify your local Newmar repair center and set up an appointment to have the defect corrected. If you are unsure of the location of your closest Newmar repair center, you may contact the Customer Service Department toll free at 1-800-731-8300. A customer service representative is available 24 hours a day, 365 days a year for operational and warranty assistance. Please have your Customer Care Card available for reference when calling for service. You may also write to:

Newmar Corporation
Warranty Department
P.O. Box 30
Nappanee, IN 46550

REPORTING SAFETY DEFECTS

If you believe your vehicle has a defect that could cause a crash or could cause injury or death, you should immediately inform the National Highway Traffic Safety Administration (NHTSA) in addition to notifying Newmar Corporation. If the NHTSA receives similar complaints, then it may open an investigation. If it finds that a safety defect exists in a group of vehicles, it may order a recall or remedy campaign. NHTSA cannot become involved in individual problems between you, your dealer, or Newmar. To contact NHTSA you may either call the Auto Safety Hot Line toll free at 1-800-424-9393 (366-0123 in Washington, D.C.) or write to:

NHTSA
U.S. Department of Transportation
Washington, DC 20590

Other information about motor vehicle safety may be obtained from the NHTSA Hot Line.

Notes



RECOMMENDED SERVICE CENTERS

ALABAMA

CAMPING CENTER RV SALES
P.O. Box 534
Prattville, AL 36067
(205)285-5269 Fax (205)285-5635

MILLICAN RV AMERICA INC.
36115 U.S. Highway 280
Sylacauga, AL 35150
(205)249-3773 Fax (205)249-3958

ALASKA

ALASKAN ADVENTURES RV CENTER
918 E. 73rd Street, P.O. Box 230427
Anchorage, AK 99523
(907)344-2072 Fax (907)344-1608

ARIZONA

B & C MANUFACTURING RV REPAIR
3528 South Dodge
Tucson, AZ 85713
(520)745-9586 Fax (909)783-3925

COURTESY CHEVROLET & RV
2145 E. Main
Mesa, AZ 85204
(602)644-1500 Fax (602)834-6474

COURTESY CHEVROLET & RV
1233 E. Camelback Road
Phoenix, AZ 85014
(602)644-1500 Fax (602)834-6474

ROAD RUNNER
440 Riverview
Bullhead City, AZ 86430
(520)758-1111

ARKANSAS

NATIONAL TRAVELERS INC.
6027 Warden Road
Sherwood, AR 72120-6098
(501)835-1704 Fax (501)835-1320

OUTDOOR LIVING CENTER
Highway 7 South, P.O. Box 1081
Russellville, AR 72801
(501)968-7706 Fax (501)968-4360

CALIFORNIA

ACACIA RV
2281 LaCrosse #502
Colton, CA 92324
(909)824-9674 Fax (909)783-3925

ALPINE RECREATION SALES & SERVICE
19380 Monterey Road
Morgan Hill, CA 95037
(408)779-4511 Fax (408)776-0104

AMERICAN CAMPER
504 Mathew Street
Santa Clara, CA 95050
(408)345-1740 Fax (408)980-9597

BARBER RV INC.
3650 E. Main Street, P.O. Box 3318
Ventura, CA 93006
(805)642-0276 Fax (805)642-9711

BRAWLEYS

5933 N. McHenry Avenue
Modesto, CA 95356
(209)521-0170 Fax (209)521-9436

CUSTOM EQUIPMENT

330 Keyes Street
San Jose, CA 95112
(408)294-2447

CUSTOM RV

1549 N. Broadway
Stockton, CA 95205
(209)462-6923

DAVE ALTMAN'S RV CENTERS, INC.

1201 Baldwin Park Boulevard
Baldwin Park, CA 91706
(818)960-1884 Fax (818)962-6906

DAVE ALTMAN'S RV CENTERS, INC.

906 RV Center Drive, Lot #5
Colton, CA 92324
(909)422-0311 Fax (909)422-0450

DAVE ALTMAN'S RV CENTERS, INC.

22020 Recreation Road
Carson, CA 90745
(310)518-6182 Fax (310)518-6195

EL MONTE RV CENTER

12061 E. Valley Boulevard
El Monte, CA 91732
(818)443-6158 Fax (818)448-5836

EL MONTE RV CENTER

565 E. Redlands Boulevard
San Bernadino, CA 92402
(909)885-2000 Fax (909)888-0420

MATT FLEMMING'S RV SERVICE CO.

69-115 Ramon Road, Ste. 1369
Cathedral City, CA 92234
(619)328-3957 Fax (619)327-2885

COLORADO

ALPINE TRAVEL TRAILERS, INC.

2487 Highway 6 & 50
Grand Junction, CO 81505
(303)242-5898 Fax (303)242-5989

JDL TRAILER SALES

2734 Lake Avenue
Pueblo, CO 81004
(719)564-8056 Fax (719)564-8059

MOUNTAIN STATES RV, INC.

14300 E. Colfax Avenue
Aurora, CO 80011
(303)360-0252 Fax (303)363-9103

CONNECTICUT

DAVE'S RV CENTER

2 Industrial Plaza Road
Danbury, CT 06810
(203)730-1744 Fax (203)730-1741

FLORIDA

INDEPENDENCE RV SALES & SVC. INC.

12705 W. Colonial Drive, Hwy. 50
Winter Garden, FL 34787
(407)877-7878 Fax (407)877-0911

LAND YACHTS INC.

1414 Commerce Lane, P.O. Box 1840
Jupiter, FL 33458
(407)745-0242 (407)745-1725

LEISURE TYME RV, INC

1490 Highway 98 W.
Mary Esther, FL 32569
(904)581-0880 Fax (904)581-2300

LEISURE TYME RV INC.

6428 Pensacola Boulevard
Pensacola, FL 32505
(904)476-6848 Fax (904)474-6392

NORTH TRAIL RV CENTER

5270 Orange River Boulevard
Ft Myers, FL 33905
(813)693-8200 Fax (813)693-8179

SOUTH FLORIDA MOTOR HOMES INC.

1955 S. State Road 7
Ft Lauderdale, FL 33317
(305)792-3930 Fax (305)584-0137

TRAVEL EASY RV INC.

4299 Highway 441 S.
Okeechobee, FL 34974
(941)467-0400 Fax (941)467-9396

TRI AM RV CENTER INC.

5441 N.E. Jacksonville Road
Ocala, FL 34479
(904)732-6269 Fax (904)368-7992

GEORGIA

C.S.R.A. CAMPERLAND INC.

3844 Washington Road
Martinez, GA 30907
(706)863-6294 Fax (706)860-5728

IDAHO

RAY'S RV'S

3340 N. Atlas Road
Coeur D'Alene, ID 83814
(208)666-1478

TREASURE VALLEY RV

4033 Chinden Boulevard
Boise, ID 83714
(208)336-7500 Fax (208)345-2521

ILLINOIS

ALL SEASONS CAMPING INC.

260 W. Grand Avenue
Elmhurst, IL 60126
(708)832-0800 Fax (708)832-0838

COLLIER RV CENTER

3510 Merchandise Drive
Rockford, IL 61109
(815)874-7188 Fax (815)874-9426

LARRY'S TRAILER SALES INC.

Highway 148 N., P.O. Box 98
Zeigler, IL 62999
(618)596-6414 Fax (618)596-6344

R & S SALES & SERVICE, INC.
218 S. Lake of the Woods Road
Mahomet, IL 61853
(217)586-2055 Fax (217)586-2382

WHISPERING PINES CAMPGROUND INC.
6245 N. Seneca Road
Morris, IL 60450
(815)942-0922 Fax (815)942-0372

INDIANA

DON'S CAMPER SALES INC.
Box 373, U.S. 41 S.
Boswell, IN 47921
(317)869-5009 Fax (317)869-5009

HART CITY RV SERVICE INC.
2301 S. Nappanee Street
Elkhart, IN 46517
(219)295-5793 Fax (219)294-2026

INDY RV CENTER INC.
State Rd. 37, S. Smith Valley Rd., P.O. Box 447
Greenwood, IN 46142
(317)881-0300 Fax (317)881-0431

LEE'S RV CENTER INC.
7247 State Road 46 E.
Batesville, IN 47006
(812)934-3210 Fax (812)934-3345

THE RV CENTER INC.
3360 E. Lincolnway
Columbia City, IN 46725
(219)244-3898 Fax (219)244-3414

TOM STINNETT HOLIDAY RV CTR. INC.
560 Kopp Lane
Clarksville, IN 47129
(812)282-7718 Fax (812)288-9424

WETNIGHT RV SALES & SERVICE INC.
4401 U.S. 41 N., P.O. Box 5197
Terre Haute, IN 47805
(812)466-3961 Fax (812)466-6851

IOWA

HEROLD TRAILER SALES
1806 W. 2nd Avenue, Highway 92 W.
Indianola, IA 50125
(515)961-7405 Fax (515)961-3674

RV CENTRAL
3001 S. 2nd Avenue
Sheldon, IA 51201
(712)324-5395 Fax (712)324-5396

WALKER TRAILER SALES, INC.
Highway 18 W., Box 633
Nora Springs, IA 50458
(515)749-2321 Fax (515)749-2321

KANSAS

HARPER CAMPERLAND INC.
1200 E. 10th, P.O. Box 1993
Great Bend, KS 67530
(316)792-5170 Fax (316)792-8466

HARPER CAMPERLAND INC.
117 W. 14th
Harper, KS 67058
(316)896-2862 Fax (316)896-2858

JAYHAWK CAMPER SALES
24105 W. 43rd
Shawnee, KS 66226
(913)422-5677 Fax (913)422-7147

WILCOX HOMES & RV CENTER
835 N.E. Highway 24
Topeka, KS 66608
(913)357-5111 Fax (913)232-1574

KENTUCKY

YOUNGBLOOD RV CENTER INC.
Rt #8, Highway 45 N.
Mayfield, KY 42066
(502)247-8591 Fax (502)247-0604

LOUISIANA

JACKIE EDGAR RV CENTER INC.
3008 Cameron Street
Lafayette, LA 70506
(318)232-1941 Fax (318)233-1147

MILLER RV
12912 Florida Boulevard
Baton Rouge, LA 70815
(504)275-2940 Fax (504)275-6807

PREMIERE RV OUTLET INC.
1700 S. Siebarth Drive
Lake Charles, LA 70601
(318)436-8785 Fax (318)436-8706

MAINE

MOUNTAIN ROAD RV
R.F.D. #1, Box 2620
Sabattus, ME 04280
(207)375-4091 Fax (207)375-4014

MARYLAND

BECKLEYS CAMPING CENTER
11109 Angleberger Road
Thurmont, MD 21788
(301)898-3300 Fax (301)898-7093

MICHIGAN

CAMPER CENTER OF CLARE
5139 E. U.S. 10
Clare, MI 48617
(517)386-9338

GAYLORD RV SALES & SERVICE
271 W. Johnson Road
Gaylord, MI 49735
(517)732-6141 Fax (517)731-2735

GENERAL TRAILER SALES-WATERFORD
5300 Highland Road
Waterford, MI 48327
(810)674-0346 Fax (810)674-3809

GENERAL TRAILER SALES-WIXOM
48500 12 Mile Road
Wixom, MI 48393
(810)349-0900 Fax (810)348-4150

HILLTOP RV & MARINE
2905 N. Lincoln Road
Escanaba, MI 49829
(906)786-7986 Fax (906)786-3421

MIDWAY MOTORHOMES INC.
5590 S. Division Avenue
Grand Rapids, MI 49548
(616)534-9641 Fax (616)534-6869

MODERN TRAILER SALES, INC.
449 S. Division Avenue
Wyoming, MI 49548-2110
(616)241-2925 Fax (616)241-5451

MINNESOTA

HILLTOP TRAILER SALES
4560 Center Avenue N.E.
Minneapolis, MN 55418
(612)571-9103 Fax (612)571-2536

LANDEY'S RV INC.
6220 Highway 101 S.
Shakopee, MN 55379
(612)445-7081 Fax (612)445-4701

SHOREWOOD RV CENTER
7405 Highway 10 N.W.
Anoka, MN 55303
(612)421-2505 Fax (612)421-6076

MISSISSIPPI

RV REPAIR & SALES, INC.
4749 Highway 80 W.
Jackson, MS 39209
(601)922-9425 Fax (601)922-5153

MISSOURI

CAPETOWN RV SALES
I-55 & Airport Road, P.O. Box 1985
Cape Girardeau, MO 63702
(314)334-7152 Fax (314)334-9059

COACHLIGHT RV SALES INC.
Route 4, Box 515
Carthage, MO 64836
(417)358-7444 Fax (417)358-0856

THOMAS BILL CAMPER SALES INC.
5217 N. Lindbergh
St Louis, MO 63044
(314)731-2217 Fax (314)731-0269

MONTANA

BRETZ RV & MARINE
2045 Mullan Road
Missoula, MT 59802
(406)721-4010 Fax (406)549-8078

NEBRASKA

DENNING RV
3110 N. Broad
Fremont, NE 68025
(402)721-5030 Fax (402)721-5570

RICH & SON'S CAMPER SALES
5112 S. Antelope Drive
Grand Island, NE 68803
(308)384-2040 Fax (308)384-2043

NEVADA

MOUNTAIN FAMILY RV
16300 S. Virginia
Reno, NV 89511
(702)849-1005 Fax (702)849-2528

WHEELERS LAS VEGAS RV
13175 Las Vegas Boulevard S.
Las Vegas, NV 89124
(702)896-9000 Fax (702)896-9001

NEW HAMPSHIRE

C. H. DANA RV SALES & SERVICE
628 Woodsville Road
Monroe, NH 03771-3328
(603)638-2200 Fax (603)638-2066

CAMPERS INN OF KINGSTON
146 Route 125
Kingston, NH 03848
(603)642-5555 Fax (603)642-9931

MOUNTAIN VALLEY RECREATION
410 Main Street
Gorham, NH 03581
(603)466-3868 Fax (603)466-2416

NEW JERSEY

SCOTT MOTOR COACH SALES INC.
1133 Route 88
Lakewood, NJ 08701
(908)370-1022 Fax (908)370-1010

NEW MEXICO

ALOHA RV INC.
11200 Central S.E., P.O. Box 53250
Albuquerque, NM 87123
(505)298-8444 Fax (505)275-7687

AMERICAN RV & MARINE
11810 Central S.E.
Albuquerque, NM 87123
(505)293-1983 Fax (505)293-6991

AMERICAN RV & MARINE
200 N. Telshore Boulevard
Las Cruces, NM 88011
(505)522-5512 Fax (505)522-3781

NEW YORK

BALLARDS CAMPING CENTER, INC.
Rte. 20 at Pleasant Av. S - 5489 Southwestern Blvd.
Hamburg, NY 14075
(716)649-9654 Fax (716)648-0340

COON TRAVEL COACH, INC.
1312 State Route 414
Beaver Dams, NY 14812
(607)936-3472 Fax (607)937-9953

SEVEN O'S
7917 Devaul Road
Kirkville, NY 13082
(315)687-9342 Fax (315)687-7992

WRATTEN TRAILER SALES
9209 Route 11 S., P.O. Box 5
Adams, NY 13605
(315)232-4535 Fax (315)232-3445

NORTH CAROLINA

HOWARD RV CENTER
6811 Market Street
Wilmington, NC 28405
(910)791-5371 Fax (910)392-0672

INDEPENDENCE RV
6600 Reames Road
Charlotte, NC 28216
(704)596-5600 Fax (704)597-7400

OLD TOWN CAMPER SALES, INC.
5109 N. Causeway Drive
Winston Salem, NC 27106
(910)924-9864 Fax (910)922-1458

RANDYS RV'S INC.
5322 Fayetteville Road
Raleigh, NC 27603
(919)779-5445 Fax (919)772-8142

NORTH DAKOTA

CAPITAL RV CENTER, INC.
1900 N. Bismarck Expressway
Bismarck, ND 58501
(701)255-7878 Fax (701)255-1678

OHIO

NATIONAL CAMPERLAND INC.
7417 W. Central Avenue
Toledo, OH 43617
(419)841-2444 Fax (419)841-2030

SIRPILLA RV CENTER INC.
1005 Interstate Parkway
Akron, OH 44312
(216)645-1991 Fax (216)645-3560

WINN'S RV CENTER INC.
6075 Dressler Road N.W.
North Canton, OH 44720
(216)494-3811 Fax (216)494-8255

OKLAHOMA

DAVE'S CLAREMORE RV INC.
1400 S. Lynn Riggs
Claremore, OK 74017
(918)341-0114 Fax (918)341-8936

EARL'S LAKE COUNTRY RV'S INC.
2601 S. 32nd Street
Muskogee, OK 74401
(918)682-4504 Fax (918)683-2691

FLOYD'S CAMPERS INC.
Route 1, P.O. Box 112 AA
Norman, OK 73072
(405)288-2355 Fax (405)288-2350

LEE'S RV CITY INC.
9300 S.E. 29th Street
Oklahoma City, OK 73130
(405)733-1753 Fax (405)733-4177

LEWIS TRAVEL TRAILER SALES
11518 E. 66th Street, P.O. Box 104
Owasso, OK 74055
(918)272-1353 Fax (918)272-5451

OREGON

AL'S TRAILER SALES OF SALEM
4843 Portland Road N.E.
Salem, OR 97305
(503)393-3365 Fax (503)393-1525

BOB'S RV COUNTRY
13555 S.W. Canyon Road
Beaverton, OR 97005
(503)644-5760 Fax (503)626-6399

DON CRUICKSHANK ENTERPRISES
98203 S B Chetco Road
Brookings, OR 97415
(503)469-3356 Fax (503)471-2782

EUGENE RECREATION SALES INC.
1700 Highway 99 N.
Eugene, OR 97402
(503)688-4849 Fax (503)688-1885

PENNSYLVANIA

ANSLEY & LEWIS, INC.
1280 Route 764, P.O. Box 239
Duncansville, PA 16635
(814)695-9817 Fax (814)695-9814

COUNCIL CUP TRAILER SALES
Route 239
Wapwallopen, PA 18660
(717)379-3751 Fax (717)379-3751

LEISER'S NORTHWOOD RV CENTER
3723 Easton-Nazareth Highway
Easton, PA 18042
(610)253-1300 Fax (610)253-7576

R.D. KENNEDY SALES & SERVICE
1394 Old York Road
Dillsburg, PA 17019
(717)432-9741 Fax (717)432-1400

ROLLING WHEELS RV
2314 Lycoming Creek Road
Williamsport, PA 17701
(717)322-1894 Fax (717)322-1902

RHODE ISLAND

ARLINGTON RV SUPER CENTER, INC.
966 Quaker Lane
East Greenwich, RI 02818
(401)884-7550 Fax (401)885-4566

SOUTH CAROLINA

TONY'S RV PARTS & SERVICE INC.
130 Pond Branch Road
Lexington, SC 29073
(803)894-3071 Fax (803)894-5385

SOUTH DAKOTA

SCHAAP'S TRAVELAND INC.
3100 W. Russell
Sioux Falls, SD 57107
(605)332-6241 Fax (605)332-5422

TENNESSEE

BROWN RV CENTER INC.
4050 N. Thomas
Memphis, TN 38127
(901)353-1999 Fax (901)353-1888

CHILHOWEE RV CENTER
4037 Airport Highway, P.O. Box 236
Louisville, TN 37777
(423)970-4085 Fax (423)984-6213

TEXAS

CUSTOM RV
10400 I-40 E., P.O. Box 9352
Amarillo, TX 79112
(806)335-2336 Fax (806)335-2338

EAST TEXAS RV SALES
Drawer J, Highway 965
Kirbyville, TX 75956
(409)423-4032 Fax (409)423-5824

RON HOOVER CO. OF BOERNE INC.
29277 Interstate Highway 10 W.
Boerne, TX 78006
(210)755-2252 Fax (210)755-8644

RON HOOVER CO. OF CORPUS CHRISTI INC.
5029 Columbia Street
Corpus Christi, TX 78416
(512)854-5383 Fax (512)851-9578

RON HOOVER CO. OF DONNA INC.
502 Frontage Road
Donna, TX 78537
(210)464-7826 Fax (210)464-7829

RON HOOVER CO. OF HOUSTON INC.
5715 N. Freeway
Houston, TX 77076-4504
(713)695-2244 Fax (713)695-2288

RON HOOVER CO. OF ROCKPORT INC.
1510 W. Market Street, P.O. Box 747
Rockport, TX 78382
(512)729-9695 Fax (512)729-9698

BILLY SIMS TRAILER TOWN
1615 Loop 289 S.
Lubbock, TX 79423
(806)745-8791 Fax (806)745-8795

BILLY SIMS TRAILER TOWN
520 E. 2nd Street
Odessa, TX 79761
(915)580-3000

VOGT MOTOR HOMES
5624 Airport Freeway
Fort Worth, TX 76117
(817)831-4222 Fax (817)831-8234

UTAH

BLAINE JENSEN & SONS RV CENTERS
220 N. 650 W.
Kaysville, UT 84037
(801)544-4298 Fax (801)546-2717

VERMONT

PETE'S RV CENTER
4016 Williston Road
S. Burlington, VT 05403
(802)864-9350 Fax (902)862-4806

VIRGINIA

KOOGLER SALES & SERVICE, INC.
Route 2, Box 193
Fishersville, VA 22939
(703)942-5556 Fax (703)943-0853

RAINBOW ACRES CAMPING RESORT INC.
Route 2, Box 16
King & Queen Courthouse, VA 23085
(804)785-9441 Fax (804)785-2608

WASHINGTON

COURTSEY FORD INC.
19873 Viking Avenue N.W.
Poulsbo, WA 98370-0866
(206)697-2700 Fax (206)697-4085

RUSS DEAN'S AUTOMOTIVE FAMILY
1225 N. 32nd Place
Pasco, WA 99301
(509)545-9500 Fax (509)547-0016

TVETEN RV COMPANY
7700 Pacific Highway E.
Milton, WA 98354
(206)922-7770 Fax (206)922-8742

WEST VIRGINIA

BRAND TRAILER SALES
2045 Fairmont Avenue
Fairmont, WV 26554
(304)366-7104 Fax (304)363-9345

BURDETTE CAMPING CENTER
3749 Winfield Road
Winfield, WV 25213
(304)586-3084 Fax (304)586-3087

SETZER'S WORLD OF CAMPING
5840 Davis Creek Road
Barboursville, WV 25504
(304)736-5287 Fax (304)736-5992

ALBERTA

MAJESTIC RV SERVICE
2612 26th Street N.E.
Calgary, AB T1Y 1A5
(403)291-1203 Fax (403)291-9561

MAJESTIC RV SERVICE Lot #2
3516 Coultts Highway S.
LETHBRIDGE, AB T1J 4K6
(403)329-6344

VELLNER LEISURE PRODUCTS LTD.
7434-50 Avenue
Red Deer, AB T4P 1X7
(403)343-1464 Fax (403)340-8135

BRITISH COLUMBIA

HI-WAY RV LAND
6736 Glover Road
Langley, BC V2Y 1S6
(604)533-3421 Fax (604)533-0975

MIDTOWN RV LTD.
64 Industrial Avenue W.
Penticton, BC V2A 6M2
(604)492-5705 Fax (604)492-0430

TRAVELAND LEISURE VEHICLES LTD.
20529 Langley Bypass
Langley, BC V3A 5E8
(604)530-8141 Fax (604)530-9576

TRIANGLE HOMES LTD.
10299 McDonald Park Rd., P.O. Box 2518
Sidney, BC V8L 4B9
(604)656-1122 Fax (604)656-2161

WESTGATE RV CENTRE LTD.
1460 Byland Road
Kelowna, BC V1Z 1A7
(604)769-4525 Fax (604)769-5766

MANITOBA

WALT'S TRAILER SALES LTD.
5195 Portage Avenue, P.O. Box 70
Headingley, MB R0H 0J0
(204)837-8388 Fax (204)831-8674

NEW BRUNSWICK

CAMPERS ALLEY LTD.
P.O. Box 929, Rue Bourque
Boucoucher, NB E0A 1G0
(506)743-8404 Fax (506)743-8495

NEWFOUNDLAND

GANDER RECREATION PRODUCTS LTD
62 McCurdy Drive
Gander, NF A1V 1A2
(709)256-2501 Fax (709)651-3139

NOVA SCOTIA

BLUENOSE HOMES CO. LTD.
RR #4, Box 549
Bridgewater, NS B4V 2X6
(902)543-2519 Fax (902)543-2209

ONTARIO

FRONTIER RV
984 Finley Avenue
Orono, ON L1S 3V2
(905)983-8000 Fax (905)983-5746

WILLIAM PATTERSON RV SALES LTD.
R.R. # 1
Dutton, ON N0L 1J0
(519)762-2125 Fax (519)762-3386

QUEBEC

RAYMOND LE BLANC INC.
1275 Des Laurentides Boulevard
Vimont Laval, PQ H7M 2Y2
(514)663-7941 Fax (514)663-2213

SASKATCHEWAN

DJ'S RV CENTRE LTD.
Thatcher Dr. E. & #1 Highway, P.O. Box 308
Moose Jaw, SK S6H 4N9
(306)694-6048 Fax (306)694-1221

CHAPTER 2

DRIVING AND SAFETY PRECAUTIONS

Table of Contents

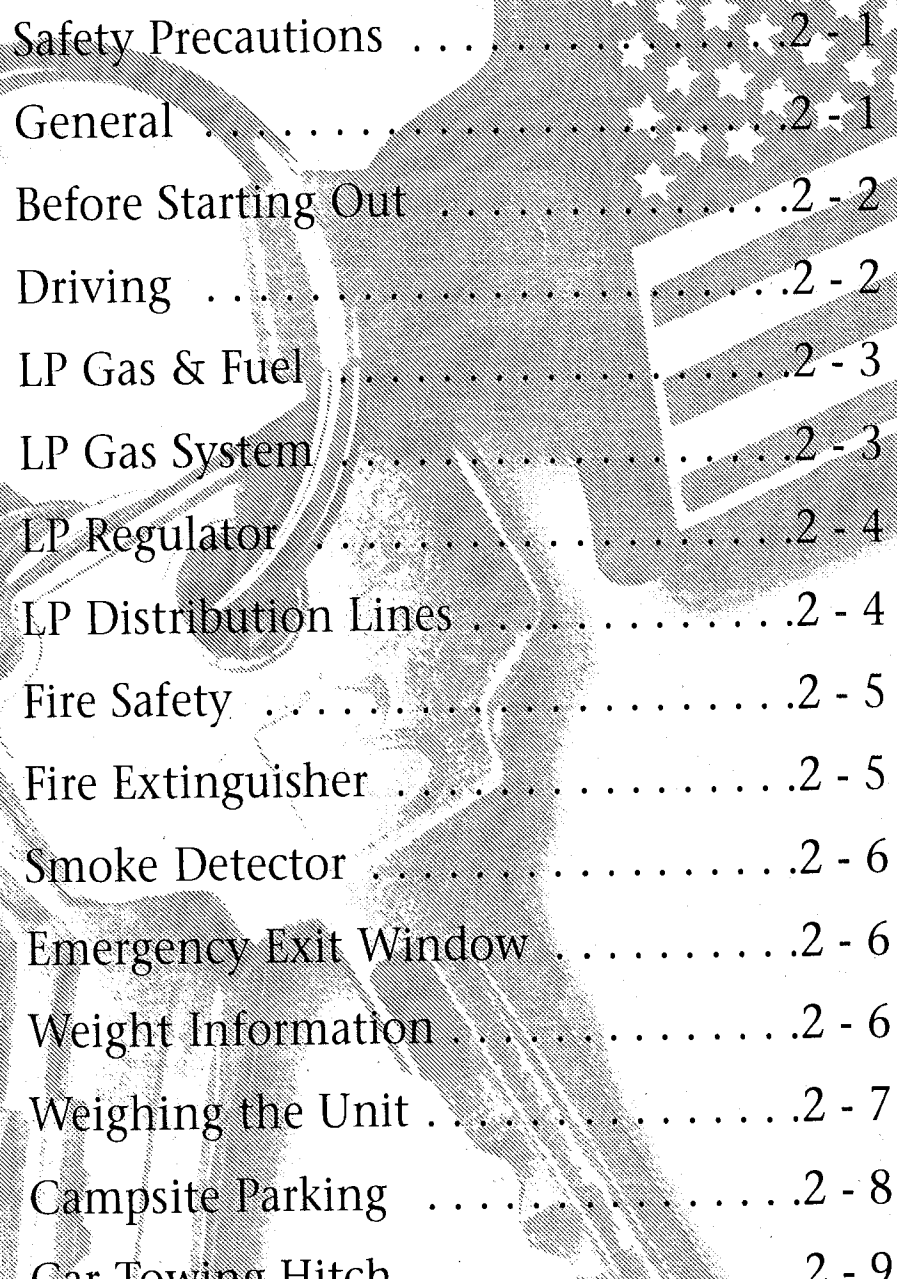

Safety Precautions	2 - 1
General	2 - 1
Before Starting Out	2 - 2
Driving	2 - 2
LP Gas & Fuel	2 - 3
LP Gas System	2 - 3
LP Regulator	2 - 4
LP Distribution Lines	2 - 4
Fire Safety	2 - 5
Fire Extinguisher	2 - 5
Smoke Detector	2 - 6
Emergency Exit Window	2 - 6
Weight Information	2 - 6
Weighing the Unit	2 - 7
Campsite Parking	2 - 8
Car Towing Hitch	2 - 9



SAFETY PRECAUTIONS

WARNING

Prior to towing your vehicle, be sure you have read this entire owner's guide and that you understand your vehicle's equipment completely and how to use the equipment safely.

Read and understand all of the instructions and precautions in this owner's guide and the chassis manufacturer owner's manual before operating your new motor home. Listed below are some safety precautions that must be adhered to while your motor home is in motion. These precautions, as well as others that involve possible damage to equipment, are also listed in the appropriate areas in this manual.

General Warning

WARNING

Portable fuel-burning equipment, including wood and charcoal grills and stoves, shall not be used inside the recreational vehicle. The use of this equipment inside the recreational vehicle may cause fires or asphyxiation.

- Seats equipped with seat belts are the only ones to be used while the vehicle is in motion.
- While the vehicle is in motion, all seats should be locked in the forward facing position.
- Passengers should never be allowed to stand or kneel on seats in a moving vehicle.
- All passengers must have seat belts fastened in a low and snug position so that the force exerted by the belt in a collision will be spread across the hip area. Pregnant women should wear the lap-shoulder belt, with the lap belt portion worn low and snug.
- The fire extinguisher should be inspected monthly for proper charge and operating condition. The smoke alarm should also be tested on a regular basis. The label on the detector should be removed when preparing the unit for the first trip. In addition to the recommended inspection, these should also be checked prior to a vacation or extended trip.
- Sleeping facilities are not to be used while the vehicle is in motion.
- Become familiar with the operation of the escape window, but use this window strictly as an emergency exit.

Before Starting Out

The following is a brief list of procedures that will aid in your driving safety and extend your equipment's life.

- Windows, mirrors, and light lenses are to be clean and unobstructed.
- Tires should be checked for proper cold inflation pressure.
- Wheel lug nuts should be checked for proper tightness.
- Fluid levels, including engine oil, transmission fluid, coolant, power steering fluid, brake fluid, and windshield washer solvent, should be checked and filled if necessary.
- Disconnect the unit and store the sewer and water supply hoses as well as shoreline power cords.
- Secure all cargo in the storage compartments in the event of a sudden stop.
- Verify that the step has retracted prior to engine ignition.

Driving

There are various adjustments that need to be made prior to starting and moving the vehicle.

- Among them are the driver's seat, the tilt steering, and the exterior rear view mirrors.
- The dashboard may contain several gauges and controls you have not previously used. Become familiar with all of these devices and their operation before starting out.
- The cruise control is not to be operated on icy roads, extremely wet roads, winding roads, heavy traffic, or in any other traffic situation where a constant speed cannot be maintained.
- While driving on slippery surfaces, use care when accelerating or decelerating. Skidding and loss of vehicle control may be the result of abrupt changes in speed.
- Driving through water deep enough to wet the brakes may affect the stopping distance or cause the vehicle to pull to one side. If you have driven through deep water, check the brake operation in a safe area to be sure they have not been affected. Never operate a vehicle if a difference in braking efficiency is noticeable.
- Extreme terrain and adverse weather may affect the handling and/or performance of your vehicle. Please refer to your chassis manual for related information.

Notes

LP Gas & Fuel

WARNING

LP gas containers, gasoline or other flammable liquids shall not be placed or stored inside the vehicle because fire or explosion may result. LP gas containers are equipped with safety valves that relieve excessive pressure by discharging gas into the atmosphere.

- While refilling the fuel or LP tank, the engine must be off, all pilot lights must be extinguished, and appliances turned off. Smoking is also prohibited at this time.
- Exhaust gases contain carbon monoxide (an odorless, colorless, and poisonous gas). These gases are produced by burned gasoline, diesel, or LP gas. Items such as the range, furnace, water heater, refrigerator, chassis engine, or generator engine can produce these gases. These fumes should not be inhaled. Inhaling carbon monoxide may produce headaches, dizziness, nausea, or even death.
- An open flame is never to be used to test for LP gas leaks.
- All protective covers and caps must be replaced after filling the LP system.
- Once the valve is closed, securely latch the LP door.
- LP gas and natural gas are not interchangeable. Never connect natural gas to the LP gas system.
- The use of equipment such as wood and charcoal grills and stoves inside this recreational vehicle may cause fires or asphyxiation.

LP GAS SYSTEM

General Information

A warning label has been located near the LP gas container. This label reads:

WARNING

DO NOT FILL CONTAINER(S) TO MORE THAN 80 PERCENT OF CAPACITY.

Overfilling the LP gas container can result in uncontrolled gas flow, which can cause fire or explosion. A properly filled container will contain approximately 80 percent of its volume as liquid LP gas.

The LP gas system components in your unit have been approved for use in camping vehicles by a nationally recognized testing laboratory. LP gas is a clean-burning dependable fuel when properly handled. The LP gas tank mounted on your unit contains liquid propane gas under high pressure. The liquid gas vaporizes as the fuel is used and passes through the tank valve

to a regulator that automatically reduces the pressure. The low-pressure gas is then distributed to the appliances through the pipe manifold system. Appliance lighting problems are commonly caused by an improperly adjusted gas regulator. Never attempt to reset the regulator yourself. Have an authorized service technician make any necessary adjustments. We recommend that you have the LP gas system checked by an authorized service technician at least once a year and after every extended trip. Although the manufacturer and dealer carefully test for leakage, travel vibrations could loosen fittings. Leaks can be easily found by applying leak detector solution at the connections. If leak detector solution is not available, a soapy water solution made with dish soap can be used. Tightening the fitting usually stops any leaks. If this does not work, shut off the main gas valve at the tank and immediately consult an authorized service technician for repairs. If a leak is suspected, the identifying odor smells similar to rotten eggs (sulfur). Never test for a leak by lighting a match or having an open flame where you suspect leaking gas.

WARNING

Shut off the main gas valve at the tank when the camping vehicle is not in use. Also, shut off the valve when refueling to avoid potential danger from pilot lights igniting fuel fumes. Some appliances, such as the refrigerator, water heater, and furnace, have DSI (direct spark ignition) boards, so it is important that you turn the appliances off when the LP gas is off. The ignition in the appliances will continue to spark even if there is no LP gas available.

LP Regulator

The regulator acts as the heart for the LP gas system. The LP gas in the tank is under high pressure. The regulator reduces the pressure of this gas so that it is safe to use with the various appliances in your unit. If corrosion is noticed, contact a qualified LP gas service technician. Do not adjust the regulator. It is factory preset. Adjustments are to be made by a qualified LP service technician using specialized equipment.

LP gas regulators must always be installed with the diaphragm vent facing downward. Regulators that are not in compartments have been equipped with a protective cover. Make sure that the regulator vent faces downward and that the cover is kept in place to minimize the vent blockage that could result in excessive gas pressure causing fire or explosion.

Distribution Lines

The primary manifold is a black steel pipe running the length of your unit. Most secondary lines leading to gas appliances are made of copper tubing with flare fittings. If any of the gas lines rupture, do not attempt to splice them. Always run a new line. We recommend gas distribution work be performed by an authorized service technician. The main valve at the LP tank must be closed when removing or servicing any gas appliance. This will prevent dangerous gas leakage that could result in an explosion and possibly serious injury. If a leak is suspected, have the systems inspected and repaired by a qualified service technician.

Precautions and Recommendations

- Inspect the LP fill valve for foreign materials before refueling.
- Shut the pilot lights off prior to refueling LP gas tanks.
- Never check for gas leaks with an open flame (match, etc.).
- Gas lines should be visually inspected periodically.
- Have the gas system inspected yearly and before and after extended trips.
- The gas system should be inspected and repaired by qualified technicians only.

WARNING

The LP system in your recreational vehicle is designed for liquefied petroleum gas only. Never attempt to connect natural gas or butane gas in this system.

FIRE SAFETY

The possibility of fire exists in all areas of life, and the recreational life-style is no exception. Recreational vehicles are complex machines. They are made up of many materials, some of which are flammable. Like most hazards, the possibility of fire can be minimized, if not totally eliminated. This is done by recognizing the danger and practicing common sense safety and maintenance habits. For safety reasons, your unit is furnished with both a fire extinguisher and a smoke alarm.

Fire Extinguisher

The fire extinguisher is rated for Class B (grease, gasoline, diesel fuel, flammable liquids) and Class C (electrical) fires. These are the most common types of fires in vehicles. Read the operator's manual and the instructions on the fire extinguisher. Be sure to know how and when to use the extinguisher and where it is located.

Fire extinguishers are mechanical, pressurized devices. Care must be exercised when they are handled. They must be maintained as the operator's manual instructs for proper and safe operation. The extinguisher should be inspected at least once a month. More frequent inspections may be required if the extinguisher is exposed to the weather or to possible tampering. Do not test the extinguisher by partially discharging. Doing this will cause a loss of pressure.

If a fire occurs in the vehicle, evacuate the vehicle as quickly and as safely as possible. Consider the cause and the severity of the fire and the risk involved before trying to extinguish it. If the fire is major or fuel fed, move away from and stand clear of the vehicle and wait for emergency assistance to arrive.

Smoke Detector

The battery powered smoke detector is mounted on the ceiling in the living area of the unit. Read the operating instructions for details on the testing and care for this important safety device. Test the smoke detector after the unit has been in storage, before each trip, and at least once a week during use. The detector should never be disabled because of nuisance or false alarm from cooking smoke or a dusty furnace. Ventilate the unit with fresh air and the alarm will shut off. Never disconnect or remove the battery from the smoke alarm. The battery should be replaced once a year or when the low battery signal sounds.

Emergency Exit Window

In the bedroom of the unit, there is an emergency exit (egress) window. This window is designed to be used as an additional exit in emergency situations. It can be easily identified by the red color of the handle and the red "EXIT" label. To open the egress window, lift the handle and push outward on the window. The window can be closed by pulling the window closed and lowering the handle to the down or locked position.

WEIGHT INFORMATION

Below is a sample of a weight information label which may appear in your unit.

MOTORHOME WEIGHT INFORMATION	
Newmar Unit Number _____	SAMPLE
Model _____	
GVWR _____	
UVW _____	
NCC _____	
GCWR _____	
GVWR (Gross Vehicle Weight Rating) means the maximum permissible weight of this motorhome. The GVWR is equal to or greater than the sum of the Unloaded Vehicle Weight plus the Net Carrying Capacity.	
UVW (Unloaded Vehicle Weight) means the weight of this motorhome as built at the factory with full fuel, engine oil, and coolants. The UVW does not include cargo, fresh water, LP gas, occupants, or dealer installed accessories.	
NCC (Net Carrying Capacity) means the maximum weight of all occupants including the driver, personal belongings, food, fresh water, LP gas, tools, tongue weight of towed vehicle, dealer installed accessories, etc., that can be carried by this motorhome. (NCC is equal to or less than GVWR minus UVW)	
GCWR (Gross Combination Weight Rating) means the value specified by the motorhome manufacturer as the maximum allowable loaded weight of this motorhome with its towed trailer or towed vehicle.	
This motorhome is capable of carrying up to _____ gallons of fresh water (including water heater) for a total of _____ pounds. Reference: Weight of fresh water is 8.33 lbs/gal; Weight of LP gas is 4.5 lbs/gal (average).	
CONSULT OWNER'S MANUAL FOR SPECIFIC WEIGHING INSTRUCTIONS AND TOWING GUIDELINES.	

Weighing the Unit

The following definitions are given to help in communications of issues of weight and your unit.

GAWR: Gross Axle Weight Rating means the maximum permissible weight for an axle. This takes into consideration the weakest link in the tire, wheel, brakes, hubs, axle, springs, and attaching parts. For example, if the axle is rated at 15,000 pounds and the tires are rated at 3,415 pounds each as a dual, the maximum GAWR would be 13,660 pounds with four tires.

GCWR: Gross Combined Weight Rating means the value specified by the manufacturer of the vehicle as the maximum allowable loaded weight of the vehicle with its towed trailer or towed vehicle.

GVWR: Gross Vehicle Weight Rating means the maximum permissible weight of this motorhome. The GVWR is equal to or greater than the sum of the Unloaded Vehicle Weight plus the Net Carrying Capacity.

UVW: Unloaded Vehicle Weight means the weight of the motorhome as built at the factory, with full fuel, engine oil, and coolants. The UVW does not include cargo, fresh water, LP gas, or dealer installed accessories.

NCC: Net Carrying Capacity means the maximum weight of all occupants, including the driver, personal belongings, food, fresh water, waste water, LP gas, tools, tongue weight of towed vehicle, dealer installed accessories, etc., that can be carried by the motorhome. NCC is equal to or less than the GVWR minus the UVW.

GVW: Gross Vehicle Weight is the weight of the unit with all items and supplies that are loaded into the unit at any point in time.

To assure the accuracy of your weights be sure the unit is always level during weighing.

The unit has been built to comply with the component suppliers recommended limits and give you a realistic NCC. When loading the unit, distribute the items so that not all of the weight is added to one area of the unit. If you have questions as to what the weight of the unit is after it has been loaded, take the unit to a drive-on scale or use individual wheel scales and verify that the weights are within the limits of those specified for the unit. When weighing the unit follow these instructions. Failure to follow these instructions may give an erroneous weight reading.

Notes

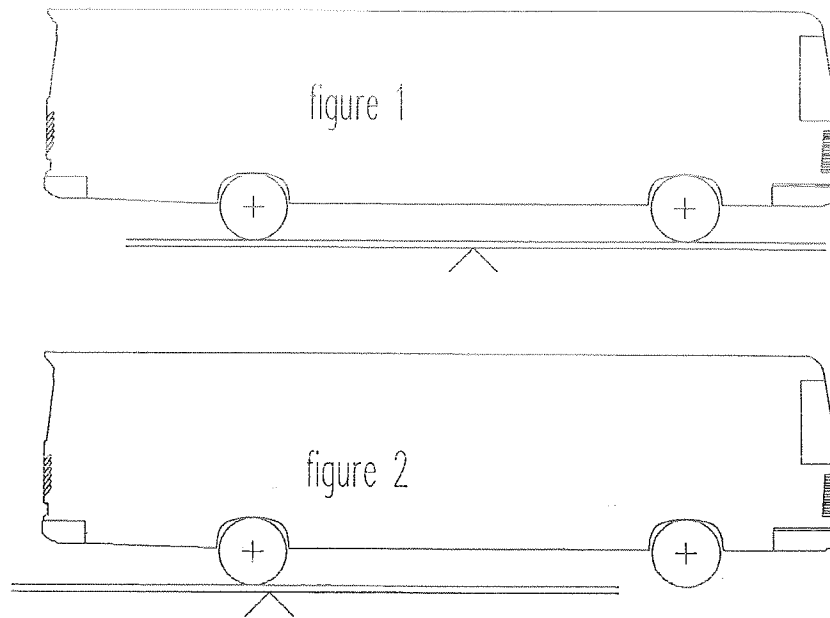

1. Pull the unit onto the scales shown in Fig. 1. This is the total weight of the unit. To do this, pull the unit onto the scales so that all of the wheels are on the scale. Record the weight. This is the GVW and should not exceed the GVWR supplied by Newmar for the unit.
2. Move the unit so that the front wheels are off the scales as shown in Fig. 2. Record the weight. This is the total weight of the unit except for the front axle. This weight should not exceed the total rating of the axles remaining on the scales. The front axle weight is determined by subtracting this weight from the GVW that was obtained in step one (1). This amount should not exceed the listed front axle weight rating.

Campsite Parking

If the campground does not have drive-through sites, it is recommended to stop near the site and inspect it for slopes or uneven areas. Back into the site carefully. Watch for low-hanging limbs, posts, large rocks, or other obstacles. Back the unit in so the site is on the driver's left, if possible. This will enable the driver to watch the rear of the unit. Back up slowly using the side mirrors as a guide or with the assistance of another person outside guiding the parking procedure.

Place the vehicle in park and turn off the ignition. If parked on a steep incline, pre-level the coach by driving the appropriate wheels onto blocks. Finish the leveling process by using the leveling jack system to level and stabilize the unit. Connect the 120 volt shore power to the unit. Open the LP gas valves at the LP tanks. Connect the fresh water supply and sanitize the water systems, if necessary. Connect the waste drain hose to the sewer hook-up. Start the refrigerator, water heater, and furnace, if needed. Light the oven pilot light, if applicable. Remember that the refrigerator will not operate efficiently if the unit is unlevel.

CAUTION

Do not lift the wheels of the unit off the ground at any time during this process. The unit can roll forward or backward when the weight of the unit is on the jacks.

CHAPTER 3

AIR CONDITIONING & HEATING

Table of Contents

Air Conditioning	3 - 1
Furnace	3 - 2
LP Tank	3 - 3
LP Tank Filling	3 - 3
LP Regulator	3 - 4
LP Detector	3 - 4



(1)



AIR CONDITIONER(S)

The air conditioner(s) installed on your coach will operate only when the unit is supplied with 120 volt AC power from the power cord or the generator. The air conditioner circuit breaker must be in the ON position to work.

To assist the air conditioner in cooling the coach, park in the shade and keep the drapes or blinds closed. Set the thermostat to the desired temperature.

Air conditioners can use a large portion of the available electric power. RV parks may experience low voltage on days with high heat or humidity. This is commonly referred to as a "brown out." A "brown out" may trip the air conditioner circuit breaker. The circuit breaker protects your air conditioner from damage and is necessary during low voltage conditions. The tripped breaker is not a fault in your electrical system.

The cool air from the air conditioner is ducted throughout the coach through ceiling air ducts. Below is the thermostat that controls the air conditioner. It also controls the furnace. Simply select the desired temperature. The blower will cycle automatically, or you may choose low, medium, or high fan settings.

If the coach is equipped with two air conditioners, both units must be in the same mode. Please consult the air conditioner manufacturer's Owner's Manual for further assistance.

Step One: Move power switch to ON.

Step Two: Press MODE button to select function. (COOL*, FURNACE, FAN ONLY, etc.)

* There is an approximate 2-minute time delay after selecting cooling function for refrigerant compressor to start.

Step Three: Press FAN button to select fan speed or automatic operation.

Step Four: Press UP or DN button to set your desired temperature for the zone.

Step Five: If your vehicle contains more than one zone, depress FAN and MODE simultaneously to select zone 2, and repeat procedures from step 2 above. Repeat entire procedure for each additional zone.

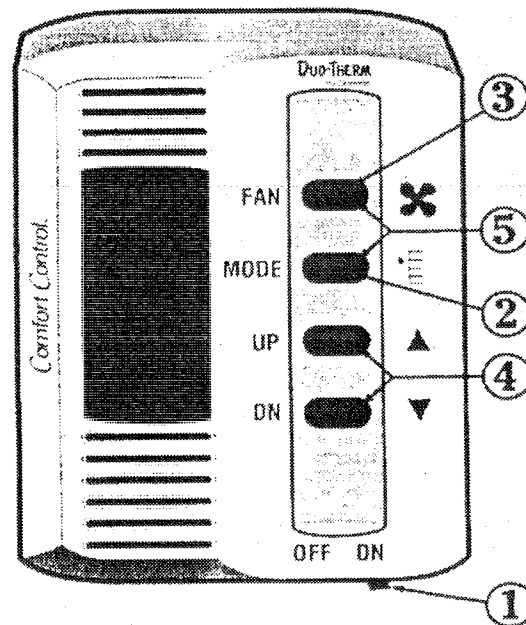

Shutdown: If you turn the Comfort Control off or if there is a power interruption for any reason, the system will resume operation on the last settings when power returns.

FURNACE

WARNING

Never attempt to modify this furnace. Fire, explosion, asphyxiation, or carbon monoxide poisoning may occur. If the furnace malfunctions, consult a trained service technician.

The furnace installed in your unit is a forced-air furnace fueled by LP gas. The furnace is controlled by the air conditioner wall thermostat. This thermostat controls both the heating and cooling of the coach.

The heat is supplied to the unit through ducts in the floor. The furnace will not operate properly if the air flow at the floor registers, or the air return to the furnace, is blocked by personal or storage items. Storage under the cabinets should be done carefully to prevent crushing or damaging the furnace ducting or blocking of the warm air return.

Smoke and fumes may be created as a result of the residual burn off of the manufacturing compounds that are sometimes present the first time the furnace is used. This is normal. To minimize the smoke and fumes, the initial lighting of the furnace should be done with the windows and doors open. Continue until the residue is completely burned off.

To operate, set the thermostat to the desired temperature setting and turn the thermostat to the on position. Allow 60 seconds for the furnace to begin operating. To shut down the furnace, turn the thermostat to the off position. After the furnace has been turned off, the fan will run for approximately 60 seconds to cool down.

For your safety, do not use gasoline or other flammable liquids in the vicinity of the furnace or any other appliance. Clean the complete furnace and air tube passageways periodically to remove dust, lint, etc. Check the gas system for leaks at least once a year. Check and clean the blower wheel annually.

On the exterior of the coach you will find a furnace cover. There are no owner serviceable parts on the furnace. This cover should be removed by authorized service technicians only.

WARNING

Use caution when washing the exterior of your vehicle. Water should not be sprayed directly into the furnace vent. If water is forced beyond the rain baffles into the furnace vent, rusting of the furnace could occur. This could also cause improper combustion.

The furnace should be thoroughly cleaned before the start of each heating season. Any debris in the system may restrict air flow for combustion, bind the combustion air impeller, or prevent the blower motor from running properly. Also, check the burner pilot orifices for debris. Lint accumulations may cause the blower to become unbalanced, vibrate, restrict the ability of the blower to move air. If lint is blown into the heat exchanger, it may cause odors or create a fire hazard. Contact an authorized service technician for annual cleaning. Consult the manufacturer's operating instructions in your Owner's Package for further information.

WARNING

Portable fuel burning appliances are not safe for heating inside the recreational vehicle. Asphyxiation or carbon monoxide poisoning can occur.

LP TANK

This unit is equipped with a 32 gallon ASME (American Society of Mechanical Engineers) approved LP tank. This tank is controlled with an automatic pressure regulator. The LP tank contains liquid petroleum gas under high pressure. As the fuel is used, the liquid gas vaporizes and passes through the tank valve to a regulator that automatically reduces the pressure. The low-pressure gas is then distributed to the appliances throughout the pipe manifold system. Improperly adjusted regulators are the major cause of appliance lighting problems. Never attempt to reset the regulator. This is to be done by a qualified service technician. While in high altitudes or extreme cold weather a gas shortage may be experienced. Running one appliance at a time can help adjust to this problem.

It is recommended to have the LP system inspected by an authorized service technician at least once a year and after every extended trip. This system is tested by both the manufacturer and the dealer. Leaks can be caused by travel vibrations; therefore routine inspections are recommended.

The primary gas supply manifold is a black steel pipe running the length of the unit. Most secondary lines leading to the gas appliances are made of copper tubing with flare fittings. If any of these lines rupture, do not attempt to splice them. Always have a new line run. Gas distribution work must be performed by an authorized service technician. When removing or servicing any gas appliance, close the main gas valve at the LP tank. This will prevent dangerous gas leakage that could result in an explosion and possible serious injury. If a gas leak is suspected, have the system inspected and repaired by a qualified service technician as soon as possible.

WARNING

The main gas valve must be shut when the vehicle is not in use. Shut the valve off when refueling to avoid potential danger from pilot lights igniting fuel fumes. Gas valves on appliances with direct spark ignition (DSI) should also be in the off position. Do not store LP, gasoline, diesel, or other flammable liquids inside the vehicle. Fire or an explosion could be the result of ignoring this warning.

LP Tank Filling

Do not fill the tank to more than 80 percent of capacity. The unit must be level when filling the LP tank. If unlevel, overfilling may occur. Fire or explosion may be the result of uncontrolled gas flow from an overfilled tank.

LP Regulator

The regulator is the heart of the LP system. The regulator reduces the pressure of the gas so it is safe to use with various appliances. Regulators are equipped with a vent. In the event excess pressure builds up in the body of the regulator, a relief mechanism vents it to the atmosphere. It will vent until the pressure returns to the normal range. The vent must be kept clean and clear of obstructions or corrosion. A clogged vent could cause the failure of components. Contact a qualified LP technician if corrosion or obstruction is noticed.

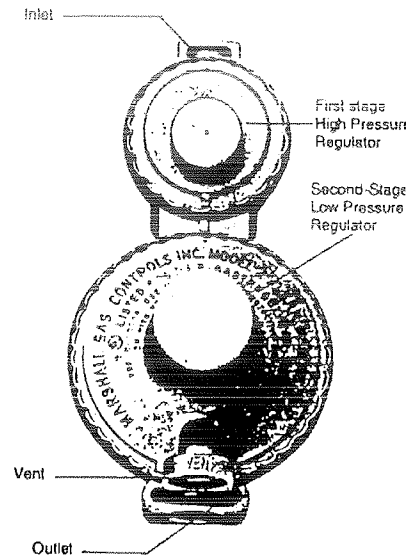

The presence of moisture in LP fuel causes the regulators to freeze. The moisture will pass through the cylinder valve and into the regulator where freezing occurs. To help prevent the regulator from freezing, always keep the tank control valve closed when not in use, even when the tank is empty, to prevent moisture from collecting on the inside.

If moisture becomes a problem, consult an authorized LP service center for assistance.

The regulator must always be installed with the diaphragm vent facing downward. Please refer to Chapter 2 of this manual for further LP gas safety information.

LP Gas Detector

WARNING

Never check gas lines for leaks with an open flame. Do not check for leaks using ammoniated or chlorinated household type detergents. These detergents can cause cracks to form on the metal tubing and brass fittings. Take the unit to a qualified LP gas service technician to find and repair the leak. Keep the tank valve closed and all of the appliances turned off when the unit is stored. If any of the LP gas valves do not close leak-tight by hand, consult a service technician.

Liquid Propane (LP) gas is heavier than air and will settle to the lowest point of the room, which is generally on the floor of your coach. Because of this, the LP detector installed in your coach is located near the floor. The detector is also sensitive to other fumes, such as hair spray, which contain butane as the propellant. Butane, like propane, is heavier than air and will settle to the floor level where it may be detected. When this occurs, press the reset button to stop the alert sound for 60 seconds.



Your Safe-T-ALERT LP detector is designed to be easy to operate. Each detector has an indicator light that constantly monitors the condition of the detector and signals the user by displaying a specific color:

The YELLOW WARM UP LED light will illuminate for about 80 seconds then the LED light will turn green. Once power is supplied, the GREEN power ON indicator light should glow continuously. If the indicator light does not light, turn off the power and check all wire connections. If the power is on and connections are correct but the indicator still does not light, the detector should be returned for service.

A GREEN color indicates an "ON" or normal condition; the LP detector has power and is sensing the air for the presence of LP gas. The alarm horn will not sound.

A YELLOW color indicates a "TROUBLE" or malfunction condition; the alarm horn will sound and cannot be reset by the TEST/RESET button. The LP detector is not working properly and must be immediately replaced or repaired.

A RED color indicates an "ALARM" condition; the detector has sensed dangerous levels of propane. The alarm horn will stay ON as long as dangerous levels of propane are present. Extinguish all flames (burners, heaters, smoking materials, etc.) and turn off all propane appliances in the area. The area should be immediately evacuated and ventilated. Turn off the propane tank valve and determine the source of the leak. Seek professional help if necessary.

For safety reasons, the detector is wired through the fuse panel under the hood of the motor home. The battery disconnect switch will not disconnect the detector from the battery.

Please consult your LP detector User's Guide for more detailed information.

Notes

CHAPTER 4

APPLIANCES & ACCESSORIES

Table of Contents

Refrigerator	4 - 1
Microwave	4 - 2
Range Hood	4 - 2
Range	4 - 2
Television Antenna	4 - 3
Television	4 - 4
Video Control Center	4 - 4
Video Cassette Recorder	4 - 5
Cable Jack	4 - 5
Telephone Jack	4 - 5
Stereo	4 - 5
Water Heater	4 - 6
Water Heater Storage	4 - 6
Water Heater Relief Valve	4 - 7
CB Radio	4 - 7
Air Horn	4 - 7
Rear View Monitor System	4 - 8
Cellular Antenna	4 - 8
Freezer	4 - 8
Safe & Security System	4 - 8
Icemaker	4 - 8
Washer & Dryer	4 - 9
Carbon Monoxide Detector	4 - 9



MAJOR APPLIANCES

Refrigerator

Before starting the refrigerator, verify that the main LP gas valve is in the on position. The refrigerator is equipped with a semi-automatic energy selector (AES) control system. It can be set to select either 120 volt or LP gas operation, automatically, if desired.

WARNING

Most LP gas appliances used in recreational vehicles are vented to the outside of the vehicle. When parked close to a gasoline pump it is possible that the gasoline fumes could enter this type of appliance and ignite the burner flame causing a fire or explosion. Use caution when refueling.

A 12 volt power supply must be available for the electronic control panel to function. The shore line must be plugged in, or the optional generator running, to operate in the 120 volt mode. The main LP gas valve must be open for operation in the LP mode. To start the refrigerator, press the main power ON/OFF button to the ON position.

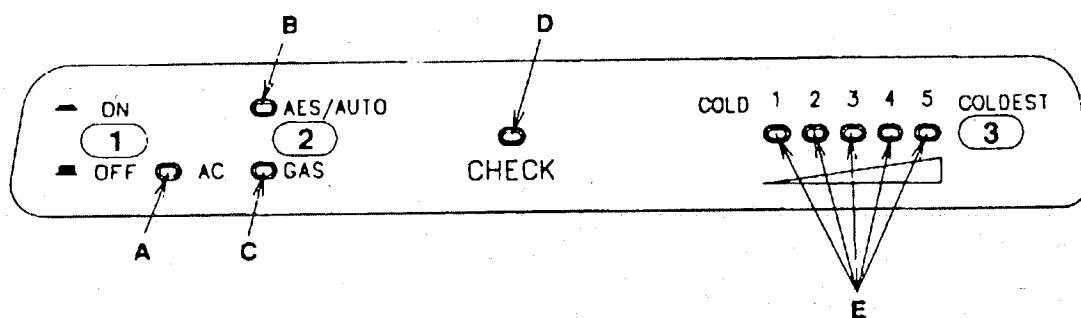

LEGEND 2-WAY AES Model

1. Main Power Button ON/OFF
2. AES/AUTO/GAS Mode Selector Button
3. Temperature Selector Button

- A. AC Mode Indicator Lamp
- B. AES/AUTO Mode Indicator Lamp
- C. GAS Mode Indicator Lamp
- D. CHECK Indicator Lamp
- E. Temperature Indicator Lamps

To use the 2-way Auto Mode, push the AUTO/GAS mode selector into the ON position. If 120 volt is available, the AC mode indicator light will be illuminated designating AC operation. If 120 volt is not available, the gas mode indicator light will be illuminated. The control system will automatically switch to gas operation. To operate on gas only, push the AUTO/GAS mode selector until the gas indicator light has lit. After 45 seconds the burner should be ignited and operating normally. The initial start up may take longer than 45 seconds in order to allow the air to be purged from the gas line. If the gas does not ignite within 45 seconds, the check indicator light will illuminate and the gas mode light will go off. If the check indicator light illuminates and the gas mode indicator light is off, then the controls have failed to ignite the burner in the gas mode. When the check indicator light is on, press the main power ON/OFF button to the off position to reset. Do not continue to reset the gas operation if the check indicator light continues to illuminate after several tries.

The thermostat on the refrigerator controls the gas and electric operation. This eliminates the necessity of resetting the temperature each time a different energy source is used. Press the temperature selector button until the light at the desired setting is illuminated. After the initial start up, the thermostat should be moved from the coldest setting to the desired setting, which is usually mid range.

An additional feature on the Dometic refrigerator is the installation of the automatic ice maker in the freezer compartment. For detailed operating instructions, please consult the manufacturer Owner's Manual in the Owner's Package.

Microwave

The microwave installed in your coach is a 30" convection microwave. All microwaves operate on 120 volt electricity. The microwave's control panel is the touch pad type. Simply enter the temperature, mode, and cooking time desired. The microwave is plugged into the electrical outlet through a surge protector. This will help protect the microwave in case of an electrical surge. For instructions on how to operate any of the special features on the microwave oven, please refer to the microwave Owner's Manual in your Owner's Package.

Range Hood

The range hood is incorporated into the microwave. The microwave's control panel operates the range hood functions. This range hood has both a fan and a light for your convenience. The fan has two speeds which are low and high. Simply select the desired setting from the microwave's control panel. For further detailed information on the hood operation, refer to the microwave Owner's Manual.

Range

There is no pilot light for the range. The burners are controlled by a spark ignition. There are different models used in the Newmar product line with different types of controls. To light the burners on some models, turn the control knob to turn the gas on. Wait a couple of seconds, then push the red spark button until a flame appears. On other models turn the spark control knob until a flame appears. All burner controls operate counter clockwise and have to be pushed inward in order to turn. For further instructions, please refer to the oven manufacturer Owner's Manual in your Owner's Package.

The following warning label has been located in the cooking area to remind the user to provide an adequate supply of fresh air for combustion:

WARNING

It is not safe to use cooking appliances for comfort heating. Cooking appliances need fresh air for safe operation. Before operation:

1. Open overhead vent or turn on an exhaust fan.
2. Open a window.

Unlike homes, the amount of oxygen supply is limited due to the size of the recreational vehicle. Proper ventilation when using the cooking appliance(s) will avoid dangers of asphyxiation. It is especially important that cooking appliances not be used for comfort heating as the danger of asphyxiation is greater when the appliance is used for long periods of time.

The following label has been placed in the vehicle near the range area:

If You Smell Gas:

1. Extinguish any open flames, pilot lights, and all smoking materials.
2. Do not touch electrical switches.
3. Shut off the gas supply at the tank valve(s) or gas supply connection.
4. Open doors and other ventilating openings.
5. Leave the area until the odor clears.
6. Have the gas system checked and leakage source corrected before using again.

TELEVISION OPERATION

Winegard Television Antenna

The TV antenna in your coach is designed for reception of all color and black-and-white channels. If the reception is poor, you should verify that the power switch is in the "ON" position and that all of the connectors are tight. If poor reception still occurs, consult your authorized dealer.

To raise the antenna into the operating position, turn the elevating crank (clockwise) in the "UP" direction, about 13 turns, or until some resistance to turning is noticed. On the power booster, turn the switch to "ON" in order to amplify the signal being received. Once in the "UP" position, rotate the antenna to receive the best picture. This is done by pulling down on the directional handle with both hands until it disengages from the ceiling plate and then rotating it until reception has improved. The antenna must be lowered before moving the vehicle. To lower, rotate the directional handle until the pointer is aligned with the pointer on the ceiling plate. Turn the elevating crank (counter-clockwise) in the "DOWN" direction, about 13 turns, or until some resistance to turning is noticed. The antenna is now locked and in the travel position.

RAISING ANTENNA TO OPERATING POSITION

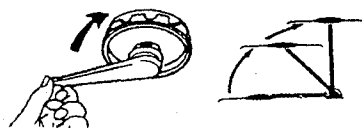

ROTATING ANTENNA FOR BEST PICTURE



LOWERING ANTENNA TO TRAVEL POSITION

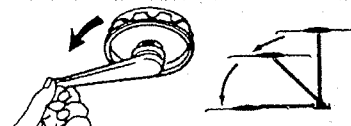

CAUTION

Under no circumstances should you lower the antenna in any position except the travel position.

Television

The coach is cable ready, and as standard equipment has a television in the dash overhead. An option would be to have a television installed in the bedroom. The televisions are powered by 120 volt electricity. Your coach must be plugged into shore power, or the optional generator running, in order for the television to work. If your coach is equipped with the optional Heart Inverter, it will invert the 12 volt power from the coach batteries into 120 volt power for some basic appliances. For more information on this, see Chapter 7 of this manual. The television operation is similar to most televisions used in the home. The main unit has the basic ON/OFF, VOL(ume) UP and DOWN, CH(annel) UP and DOWN, and Menu buttons. The remote control has these in addition to many other function keys. Please consult your television Owner's Manual for further information. One television jack is installed as standard equipment. An additional jack may be optioned.

Video Control Center

Installed in your vehicle as part of the standard equipment is the Audio Video Control Center (AVCC). The AVCC will direct the signal to one or two televisions and one VCR. Simply push a button to select what is viewed and where. To control what is being viewed on the front television use the selections for "TV 1." To control what is being viewed on the bedroom (and outside television, if desired) use the selections for "TV 2." Each television is capable of viewing different programming at the same time. For example, by selecting "ANT" for "TV 1" you are able to watch your favorite network broadcast on the front television, while a movie from the VCR is being watched in the bedroom or outside, after selecting the "VCR" button for "TV 2." This control center is capable of receiving three sources of input. They are "FROM ANTENNA," "FROM VCR," and "FROM AUX." The "FROM AUX" selection is used for cable input. It will also accommodate video game systems or a satellite dish.

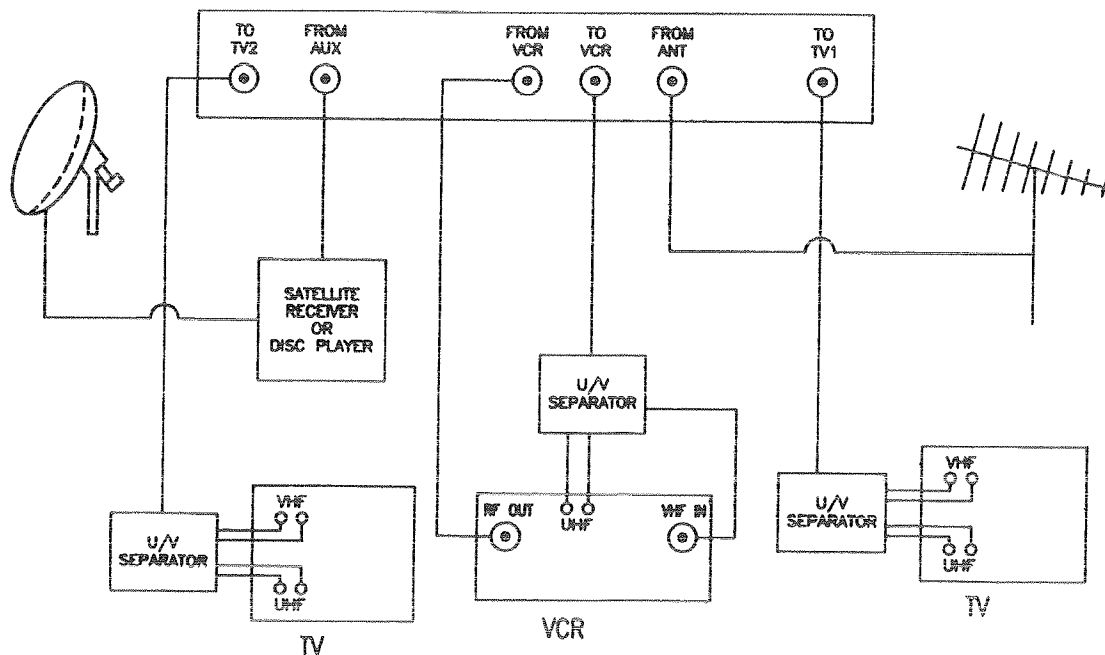

Video Cassette Recorder

The video cassette recorder (VCR) is installed in your coach as standard equipment. It is in the living room entertainment center. The controls are on the face of the VCR and on the remote control. For more detailed information regarding the VCR functions consult the VCR Operator's Manual in the Owner's Package. The video switch described above will assist you in directing the VCR signal to the television of your choice.

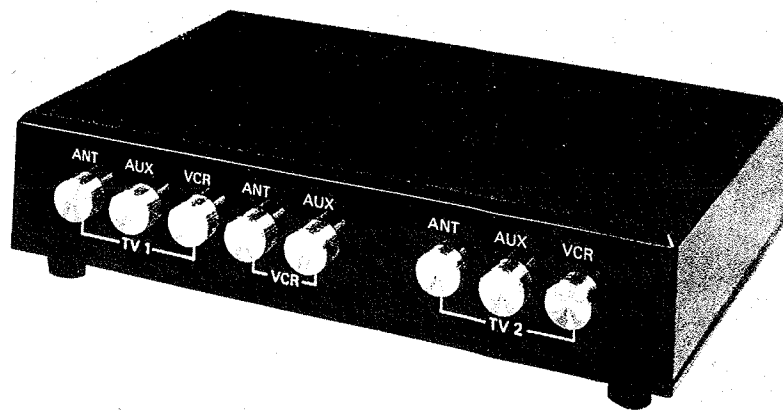

Cable and Telephone Jack

Optional on your unit are two cable television jacks. One is an interior jack installed where specified. The other is an exterior jack for use on the door side of the unit. An additional feature in this unit is the telephone hook up. This includes the connector for the incoming telephone line and one telephone outlet inside the unit.

Stereo

The standard dash stereo installed in your coach is an AM/FM Cassette player. The operation of this stereo is similar to that of many car stereos. The stereo operates on 12 volt electricity from the coach batteries. There are speakers located throughout the coach for listening pleasure. For further information on the operation of this stereo, consult the stereo manufacturer Owner's Manual in the Owner's Package.

WATER HEATER

WARNING

Do not light the water heater until it is filled with water. There is a switch on the exterior of the water heater labeled "Electric." This switch must be in the "ON" position for the water heater to work in the electric mode.

Before lighting the water heater, fill the fresh water system. Purge any air from the water heater by opening all hot water faucets until water flows steadily from each one. The water heater installed in this unit is a ten gallon gas/electric model with direct spark ignition. This water heater operates on either LP gas or 120 volt electricity.

It is important to read all of the safety information provided in the water heater manufacturer's Operation Manual in the Owner's Package. The following instructions are for the standard water heater with direct spark ignition (DSI). This appliance does not have a pilot light. It is equipped with an ignition device that automatically lights the burner. Do not try to light the burner by hand. Before lighting, smell all around the appliance area for gas. Be sure to smell next to the floor because some gas is heavier than air and will settle on the floor. Consult the Operation Manual for further instructions if a gas leak is noticed. The gas valve is fully automatic; no adjustments are necessary. Read the safety information provided in the Operation Manual before lighting the appliance. Turn off all of the electrical power to the water heater. Turn the gas supply to the "OFF" position. Wait five minutes for the gas to clear the area. If you smell gas, STOP! Follow the safety instructions in the Operations Manual. If gas odor is not noticed, then turn the gas supply to the "ON" position. Turn on the electrical supply to the water heater. Inside the coach there is a switch marked "WATER HEATER." Turn the switch to the "ON" position. There will be a 15 second purge before the unit will spark. If the burner does not light on the first try, there will automatically be 2 more tries for ignition before it will lock out. Each ignition cycle will have a 15 second purge. If lock out occurs before the main burner lights, turn the switch to "OFF," wait five seconds, and turn the switch to "ON" again. This will re-start the ignition cycle. The initial start-up of the water heater may require several ignition cycles before all of the air is purged from the gas lines.

WARNING

Do not store any combustible materials or liquids near or adjacent to the water heater.

Storage

When storing your coach for the winter months, the water heater must be drained to prevent damage from freezing. The first step is to turn off all electrical power and LP gas going to the water heater. The water pump must also be turned off. Open both the hot and cold water faucets to drain the lines. Open the drain on the water heater. Drain the entire water system. When preparing the unit for use after it has been stored, make certain the water system, including the water heater, has been filled before re-lighting the water heater. Failure to fill the water heater before lighting may damage the water heater and void the warranty.

Pressure Relief Valve

The temperature and pressure relief valve is located on the exterior of the water heater. It is designed to open if the temperature of the water within the heater reaches 210° F, or if the water pressure in the heater reaches 150 pounds. Recreational vehicle water systems are closed systems, and during the water heating cycle the pressure build-up in the water system may reach 150 pounds. When this pressure is reached, the pressure relief valve will open and water will drip from the valve. This dripping will continue until the pressure is reduced to below 150 pounds and the valve closes. This condition is normal and does not indicate a defective relief valve.

WARNING

Do not plug the relief valve under any circumstances.

CB Radio (Optional)

This coach may be equipped with the optional citizens band (CB) radio. This radio can be used to communicate with other travelers on the road. The model installed is a remote type. The hand held microphone/speaker contains the power, volume, and channel controls. Simply turn on using the power/volume control. Then select the channel you wish to monitor. Press the "Push-to-Talk-Switch" to transmit and release to receive. For more information regarding the operation of this CB radio, please consult the radio manufacturer's Owner's Manual.

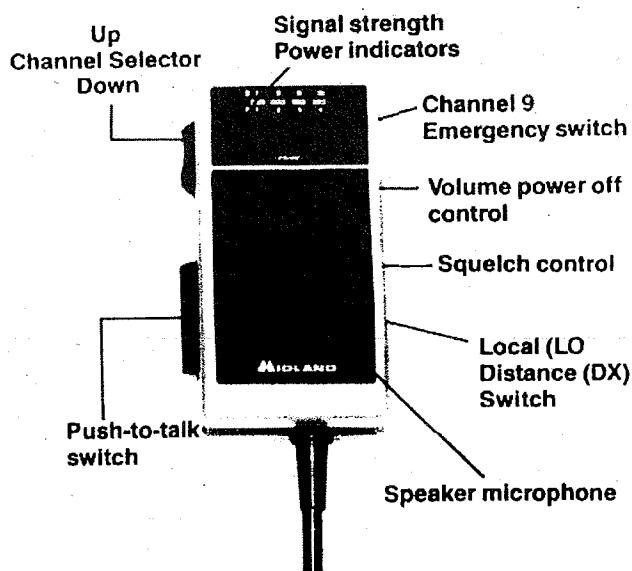

Air Horn

An air horn has been installed on this coach. This air horn is in addition to the horn installed on the chassis. A switch located on the dash allows you to choose either the chassis horn or the air horn. To operate either horn, press the center of the steering wheel.

Notes

Rear View Monitor System

Installed as a standard feature, the rear view monitor system assists the driver in the backing and parking of the vehicle. This system consists of a camera mounted on the rear cap and a monitor located on the dash. With the MODE switch in the "MANU" position, the monitor will be on when the ignition is turned on. With the MODE Switch in the "AUTO" position, the monitor will display the picture from the camera when the vehicle transmission is placed in reverse (R). For detailed instructions on this and all procedures regarding the monitor system, refer to the monitor Operating Instructions in the Owner's Package supplied with this coach.

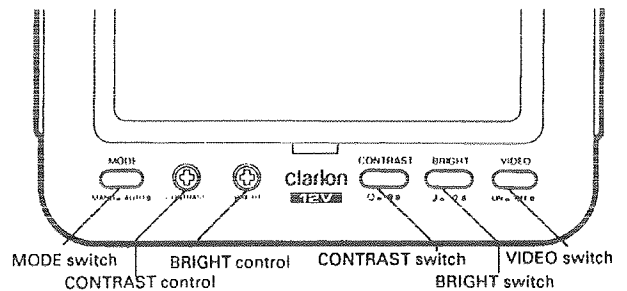

Cellular Antenna (Optional)

The installation of an antenna for use with a cellular telephone is an optional feature on this coach. If installed, the antenna would be on the roof of the unit for optimum transmission and reception with most cellular telephones. The antenna wire would terminate under the dash for ease of connection.

Freezer (Optional)

The installation of a freezer in an exterior storage compartment is an optional feature on this coach. This freezer operates on 12 volt and 120 volt electrical power. The freezer is on slides to move easily in for storage while traveling or out for pre-travel packing or campsite unloading. For detailed instructions on the operation and maintenance of this freezer, please consult the freezer manufacturer Owner's Manual in the Owner's Package provided with this coach.

Safe & Security System (Optional)

For your safety and the safety of your belongings, an optional feature on this coach is a safe and an electronic security system. For operation of these items, refer to the manufacturer Owner's Information in the Owner's Package.

Icemaker (Optional)

A possible option on some models is the installation of an icemaker. The icemaker operates on 120 volt electricity. If optioned, it would be installed under the three burner hot plate. For detailed information, consult the icemaker manufacturer Owner's Manual in the Owner's Package provided with your new coach.

Washer/Dryer (Optional)

The plumbing and other preparations for the installation of a washer and dryer are optional on this coach. To have the washer and dryer factory installed is also an option. The washers and dryers used by Newmar function as those in a home, operating on 120 volt electricity. For more detailed information on the operating instructions, read the appliance Owner's Manual in the Owner's Package.

Carbon Monoxide

Carbon monoxide is a colorless, tasteless, odorless gas. It is a by-product of the burning of fossil fuels (gasoline, LP gas, diesel fuel, etc.). The chassis and generator engines, furnaces, water heater, LP gas refrigerator, and range produce carbon monoxide constantly while they are operating. Carbon monoxide is DEADLY. Please read and understand the following precautions to protect yourself and others from the effects of carbon monoxide poisoning.

WARNING

Exhaust gases are deadly. Do not block the tailpipes or exhaust ports. Do not situate the vehicle in a place where the exhaust gases have any possibility of accumulating either outside, underneath, or inside your vehicle or any nearby vehicles. Outside air movements can carry exhaust gases inside the vehicle through windows or other openings remote from the exhaust outlet. Operate engines, carbon monoxide-producing systems, or components only when safe dispersion of exhaust gases can be assured. Monitor outside conditions to be sure that exhaust continues to be dispersed safely.

If you, or anyone else, experience any carbon monoxide symptoms (dizziness, nausea, vomiting, muscular twitching, throbbing in the temples, inability to think coherently, weakness and sleepiness, or intense headaches) exit the coach immediately. Seek medical attention if symptoms persist. Shut down the unit and do not operate it until it has been thoroughly inspected and repaired.

WARNING

UNDER NO CIRCUMSTANCE SHOULD YOU OPERATE ANY ENGINE WHILE SLEEPING. When you are sleeping you will not be able to monitor outside conditions to assure that engine exhaust does not enter into the coach. Check the exhaust system frequently for damage. If damage is found, do not operate the system. Never modify the exhaust system(s) in any way.

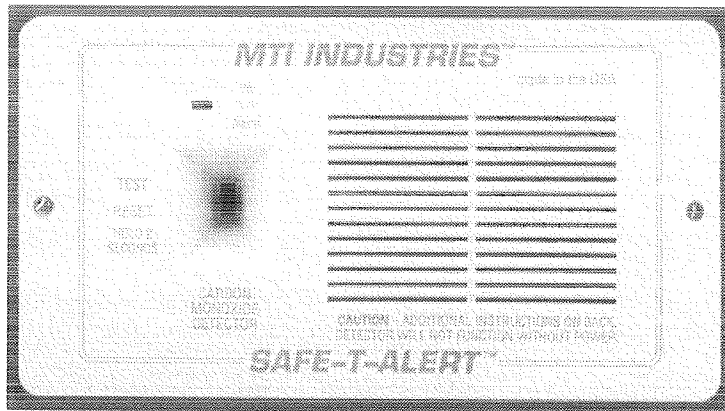

Each Safe-T-ALERT CARBON MONOXIDE detector is equipped with a self-cleaning CARBON MONOXIDE sensor and requires a ten (10) minute initial warm-up period to clean the sensor element and achieve stabilization.

The GREEN power ON indicator should glow continuously when power is on. If the indicator light does not light, turn off the power and check all wire connections. If the power is on and connections are correct but the indicator still does not light, the detector should be returned for service. Do not attempt to fix it yourself.

Your Safe-T-ALERT carbon monoxide detector is designed to be easy to operate. Each detector has an indicator light that constantly monitors the condition of the detector and signals the user by displaying a specific color.

A GREEN color indicates an "ON" or normal condition; the carbon monoxide detector has power and is sensing the air for the presence of carbon monoxide gas. The alarm horn will not sound.

A YELLOW color indicates a "TROUBLE" or malfunction condition; the alarm horn will sound and cannot be reset by the TEST/RESET button. The carbon monoxide detector is not working properly and must be immediately replaced or repaired.

A RED color indicates an "ALARM" condition; the detector has sensed the presence of hazardous levels of carbon monoxide. The alarm horn will sound continuously until reset by the RESET button. The area should be immediately ventilated, and all persons and animals must leave the location.

For safety reasons, the detector is wired through the fuse panel under the hood of the motor home. The battery disconnect switch will not disconnect the detector from the battery.

Please consult your carbon monoxide detector User's Guide for more detailed information. See procedures to take during an alarm as described in your Carbon Monoxide Detector User's Manual.

CHAPTER 5

CABINETS & FURNITURE

Table of Contents

Cabinets	5 - 1
Furniture	5 - 2
Living Room Area	5 - 2
Bedroom Area	5 - 3

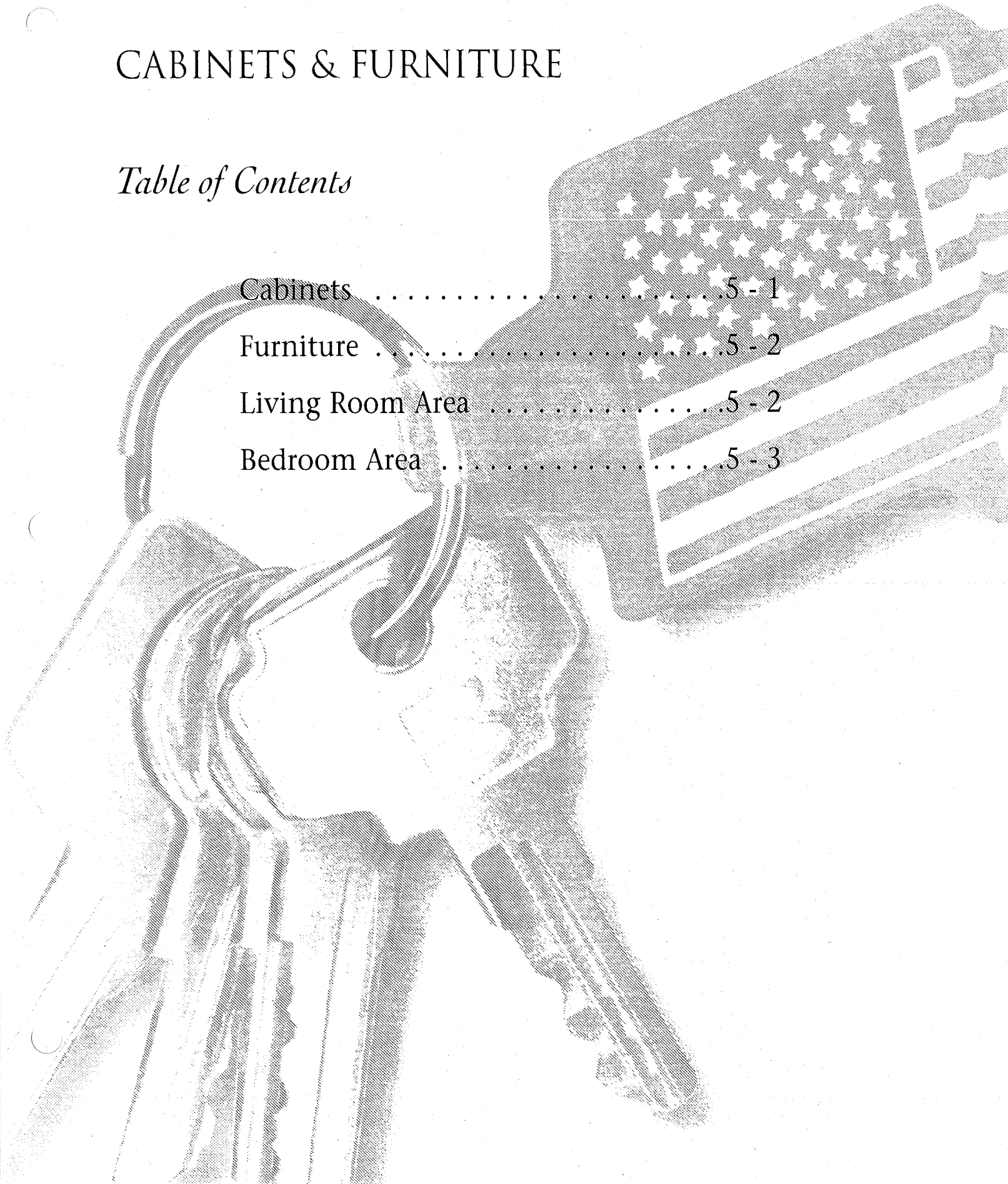



CABINETS

The cabinets in this unit are constructed on site at the Newmar production facility. Oak frame doors with cathedral style raised panels are standard throughout the unit. A decor option available is bleached oak. All decors have brass door and drawer handles. These give the interior an added touch of class.

Depending upon the floorplan, this unit may be equipped with a counter top extension. If installed, the extension will provide additional counter space while cooking and fold out of the way while entertaining. The silverware drawer contains a molded silverware divider tray for added storage.

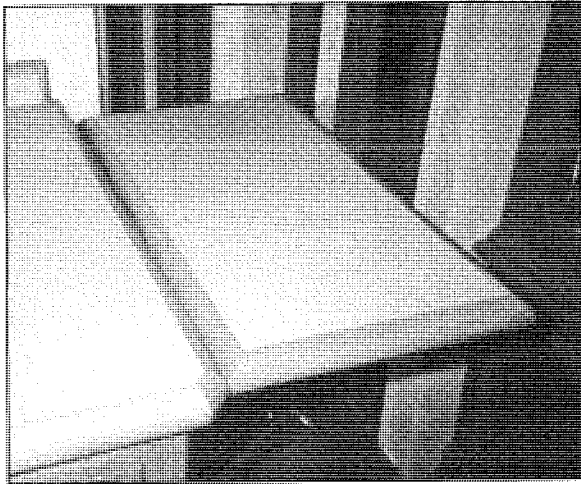

Storage is an important factor to all RV owners. Keeping this in mind, the cabinetry is structured to provide as much storage as possible. Some models have pantry style cabinets in the kitchen for added storage. On other models, you may option a pull out pantry for storage ease. In the bedroom on all models, the bed platform lifts for convenient storage. This platform is held open by pressurized struts to allow hands-free access.

The countertop in the kitchen and bath is made of a decor matching laminate. On most floorplans, the "drawer" directly in front of the kitchen and lavatory sink does not pull out, but rather flips down. This provides a storage tray for dish cloths, scouring pads, wash cloths, etc.

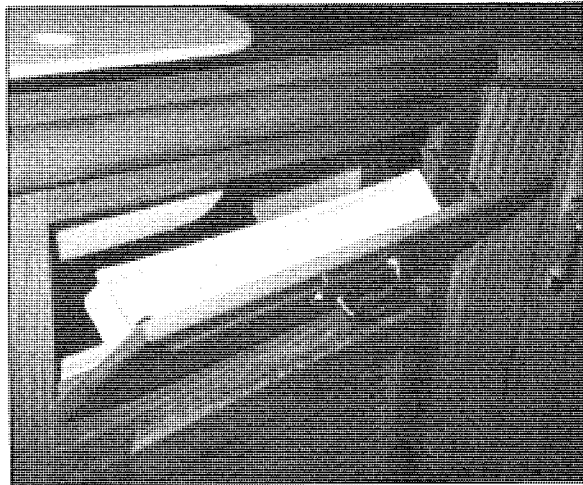

Drawer guides are standard on all of the drawers. These guides provide a smooth opening and closing of the drawers. To open a drawer, lift up slightly and pull open. The way this mechanism works will prevent the drawers from unintended opening while traveling. The drawers are constructed with maple panel bottoms for added strength.

All of the cabinetry can be easily cleaned with any commercial furniture cleaner or polish. As with any wood product, do not saturate these cabinets with water or any other liquid. Be sure to wipe up spills as they occur to avoid staining.

FURNITURE

Living Room Area

A standard feature in the kitchen area is the free-standing dinette. This includes a hardwood table and four chairs. The chair seats and backs are designed with a coordinating upholstery fabric to match your decor.

One popular option in this unit is the built-in dinette booth. The built-in dinette would be installed in place of the free standing table and chairs. The dinette provides added storage under the seat area of the booth, along with an extra sleeping area. The sleeping area is made by dropping the table top and arranging the cushions.

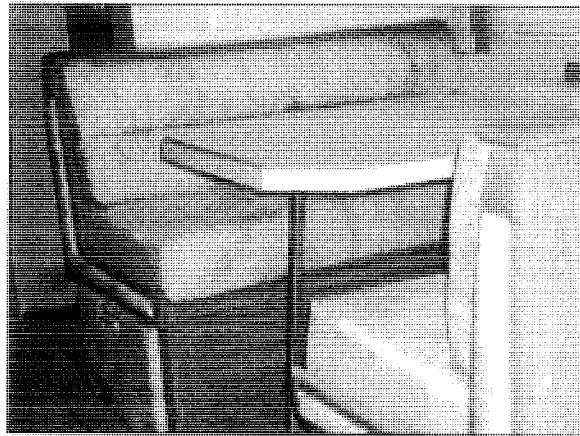

Another option on some models is the hidden leaf dinette table. This option is in place of the standard dinette table. The chairs with this option are the standard set of four.

In the living room, the standard sofa is a Flexsteel sleeper sofa. This sofa converts into a sleeping area by holding and pulling up on the bottom cushion while pushing down on the back cushion. The sofa is upholstered in decor matching fabric. If you have any questions regarding the warranty on this sofa, contact Flexsteel, the sofa manufacturer.

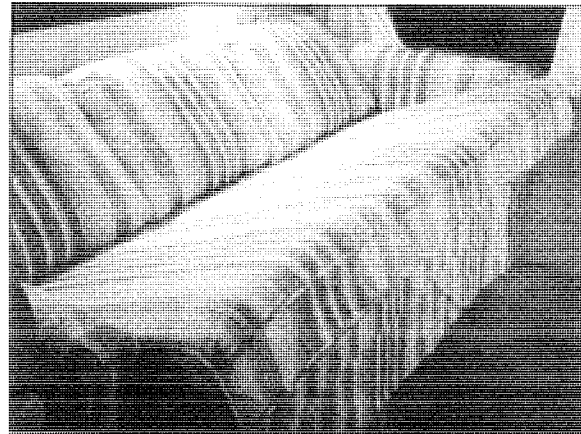

The standard living room chair, on most floor plans, is the Flexsteel swivel glider/recliner. There are two optional chairs in place of the standard. They are the petite glider/recliner and the swivel rocker. On most floor plans, the recliner end table is standard.

The driver and passenger seats are equipped with three-point seat belts. These should be used whenever the vehicle is in motion. To adjust the driver's chair for driving ease, the optional six-way electric powered base will move the chairs forward and backward, as well as up, down, forward and reverse tilt. These chairs also have swivel and recline features. When the unit is not in motion, they can be swiveled to face the living room of the unit. To turn the chairs, first extend the slide out room. Then move the chair backwards all of the way to provide enough clearance for the steering wheel. Once this is done, the chair will swivel without interference. An added feature of this option is the power lumbar support. The control switch is located on the left hand side in front of the power base controls. Pushing the switch forward will inflate the support while pushing back will deflate it.

CHAPTER 6

STRUCTURE FEATURES

Table of Contents

Chassis Features	6 - 1
Alignment	6 - 1

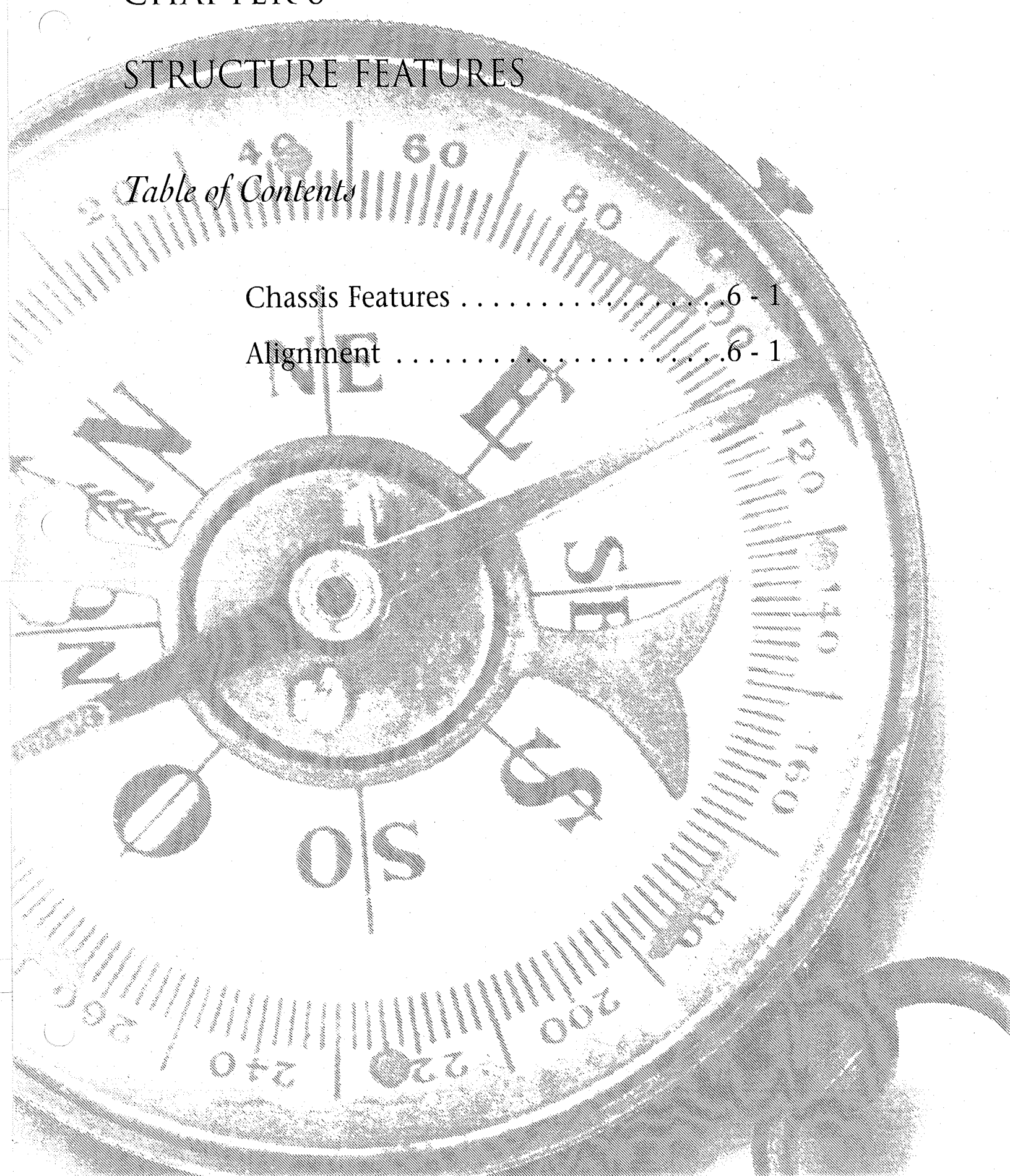



(14)



CHAPTER 7

ELECTRICAL FEATURES

Table of Contents

General Information	7 - 1
Breaker Boxes	7 - 1
Electrical Diagrams	7 - 1
Batteries	7 - 2
Battery Boost Switch	7 - 2
Battery Inspection & Care	7 - 2
Battery Disconnect Panel	7 - 3
12 Volt Receptacles	7 - 4
120 Volt Receptacles	7 - 4
GFCI Receptacles	7 - 4
Heart Inverter/Converter	7 - 5
Daytime Running Lamps	7 - 5
Spotlight	7 - 5
ICC Flasher	7 - 5
Generator	7 - 5
Automatic Transfer Switch	7 - 6
Wiring Connector	7 - 6
Resettable Breakers	7 - 7



ELECTRICAL SYSTEMS

General Information

There are two electrical systems in your coach. They are the 12 volt DC system and the 120 volt AC system. Most standard appliances require 120 volt electricity while the majority of the lighting used in recreation vehicles is powered by 12 volt electricity. The power for the 12 volt system is supplied by the coach batteries, which are charged by the 75 amp power converter. The power for the 120 volt systems is supplied by the power cord when the unit is connected to an outside power source or by the generator. If installed, the optional inverter can also supply 120 volt power. It will transform 12 volt electricity from the batteries into 120 volt power for basic appliances.

CAUTION

Failure to turn off the 120 volt appliances when starting or stopping the generator may damage the transfer switch and/or electrical appliances.

To connect the unit to 120 volt shore power, first make sure all of the breakers are in the off position. This is done to avoid a power surge. Unwind the power cord from the electrical compartment. The standard electrical service in this unit is 30 amps. A 50 amp service can be optioned in place of the standard. Check to make sure the pins in the outlet are oriented correctly, that they match the power cable, and that they are in good condition. If there is a circuit breaker switch at the plug, it should be turned OFF before making the connection. Insert the plug completely into the outlet and turn the circuit breaker on. Close and lock the electrical compartment door to keep the contents clean, dry, and secure. Close the cover on the power box, if equipped, to avoid an unintended disconnection and to keep contents clean. Switch the main breaker to the ON position. The 120 volt system will energize all 120 volt circuits and outlets when the main breaker is turned on.

Breaker Boxes

The 120 volt and 12 volt breaker boxes are generally located in the overhead cabinet on the rear bedroom wall. Circuit breakers and fuses are installed to protect the electrical system from overloading. Do not attempt to change the circuitry or add appliances yourself. Please consult an authorized Newmar Service Center.

Electrical Diagrams

In Chapter 15, you will find typical 12 volt and 120 volt electrical diagrams.

Batteries

The coach or house batteries on your motor home are installed by Newmar Corporation. These batteries are warranted by the battery manufacturer. The chassis batteries on your motor home are installed and warranted by the chassis manufacturer. The coach batteries are used to operate the 12 volt items that are not a direct part of the chassis. They are located on a pull out drawer in an outside compartment.

CAUTION

Do not use the motor home with the coach batteries disconnected.

The coach and chassis batteries are recharged by the vehicle's electrical system whenever the engine is running. A decline in the coach battery voltage may be noticed while the chassis batteries are being charged. The converter will automatically charge the coach batteries when the unit is connected to a 120 volt outside power source. The chassis batteries are isolated from the coach batteries. This prevents the chassis batteries from being drained by the interior 12 volt equipment, allowing ample voltage for engine ignition.

Battery Boost Switch

The battery boost switch is located on the dash. This switch briefly connects the coach batteries to the chassis batteries. This allows the chassis batteries to borrow power from the coach batteries to assist in starting the engine. If the chassis batteries cannot turn the engine over in the normal mode, hold down the battery boost switch and attempt ignition. By using the battery boost switch while trying to start the chassis engine, a jump start situation is created between the coach and chassis batteries. If the battery boost switch is required to start the engine on a regular basis, ask your dealer to check the chassis batteries and charging system.

Battery Inspection & Care

WARNING

Remove rings, metal watch bands, and other metal jewelry before working around batteries. Use caution when using metal tools. If a tool contacts a battery terminal or metal connected to it, a short circuit could occur which could cause personal injury, explosion or fire.

CAUTION

Disconnect the 120 volt electrical power cord and the negative terminal from the coach batteries before working on the electrical system.

Remember that when batteries are not used for an extended period of time, they may lose their charge. Periodic charging of the batteries during storage of the unit will increase the life of the battery. Check the external condition of the battery periodically. Look for cracks in the

cover and case. Check the vent plugs and replace them if they are cracked or broken. Keep the battery clean. Accumulations of acid film and dirt may permit current flow between the terminals, which could drain the battery.

To clean, wash the batteries with a diluted solution of baking soda and water to neutralize any acid present. Rinse thoroughly with clean water. Foaming around the terminals or on top of the battery is a sign that acid is being neutralized. Avoid getting the baking soda solution in the battery. Secure all vent caps. Dry the battery cables and terminals to prevent corrosion. Do not use grease on the bare metal inside the cable terminals. Grease can act as an insulator, and electricity will not flow through it. A plastic ignition spray will protect the terminals after they have been cleaned.

WARNING

Do not allow the battery fluid to contact your skin, eyes, fabric, or painted surfaces. The fluid could cause serious personal injury or property damage. Wear eye protection when working with any battery.

The batteries should be removed and stored in a warm place when not using your motor home for an extended period of time. Mark the cables, positive and negative, for easy identification. Batteries are not to be stored on concrete floors. The batteries require periodic charging during storage. If the motor home is to be stored for a long period of time, it is recommended that all of the batteries inside the unit be removed from clocks, radios, smoke alarms, etc. This will prevent unnecessary drain and corrosion of the batteries. The coach batteries are 6 volt RV/Marine deep cycle batteries. This type of battery consumes water and must be filled periodically. Consult the owner's manual supplied by the battery manufacturer. This can be found in the Owner Information Package received with this unit.

Battery Disconnect Panel

The battery disconnect panel is located above or near the entrance door. There are two switches on the panel. The top switch is used to measure the battery voltage. The lower switch is used to disconnect the battery when the unit is stored for any period of time. Pressing downward disconnects the coach batteries, not the chassis batteries. This is done to prevent the coach batteries from being drained during storage. It disconnects all of the 12 volt circuitry from the batteries, with the exception of the CO and LP detectors. For information regarding the disconnection of the power to the two detectors, see DETECTORS. When taking the unit out of storage, press upward to re-connect the batteries. This will make the 12 volt system ready for use.

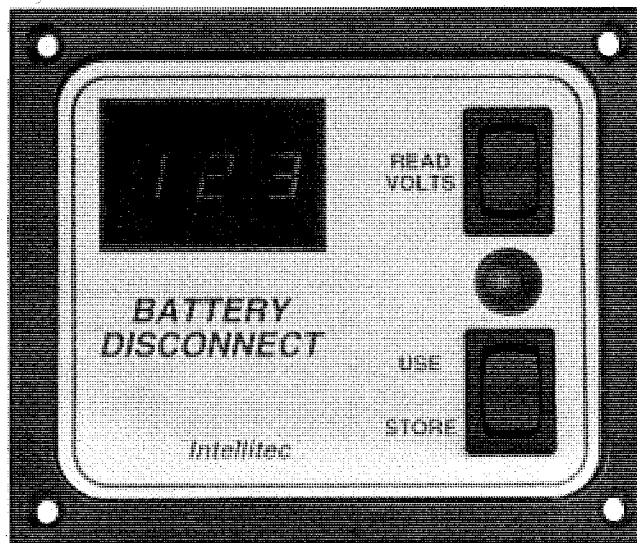

Diesel pusher motor homes are equipped with a second disconnect switch strictly for the chassis batteries. This "Master Kill Switch" is located in the rear engine compartment. It is used to prevent accidental ignition when the engine is being serviced.

12 Volt Receptacles

Your unit is equipped with several 12 volt receptacles conveniently located in the dash area. One is located on each of the ashtrays beside the driver's or passenger's chair. There are also two other receptacles located on the dash. These 12 volt receptacles can be used for items such as cellular phones or personal computers.

120 Volt Receptacles

For your convenience, there are 120 volt receptacles located throughout the interior of the unit. These receptacles require three-pin plugs that provide proper grounding to protect you from electrical shock. Do not use an adapter, cheater, or extension cord that breaks the continuity of the ground circuit to the ground pin. Never remove the ground pin from a plug in order to connect it to a two-pronged ungrounded outlet. Never operate the camping vehicle with an electrical short. An electrical short may cause the exterior of the unit to shock you when touched. If you feel even the slightest shock, disconnect the unit from the 120 volt power source and locate the fault. It is usually a break in the grounding circuit. The grounding circuit must be continuous from the frame to the distribution panel, to the power cord, and to the earth ground.

Ground Fault Circuit Interrupt Receptacles

The 120 volt electrical outlets in the kitchen and bath area are ground fault circuit interrupt (GFCI) receptacles. The GFCI outlets provide an overload and short circuit protection. The electrical outlets located in the slide out are wired through the kitchen GFCI. The exterior electrical outlets are wired through the bathroom GFCI. If an item plugged into a slide out or outside receptacle is not working, check for a tripped GFCI in the kitchen or bathroom. In addition, these outlets protect the user from ground faults between a hot wire and ground. The GFCI will not reduce the shock hazard if the short is between a neutral and hot wire, or two hot load wires.

The GFCI should be tested at least once a month. The 120 volt electrical system must be on in order to test the GFCI. The reset button needs to be pushed in all of the way before starting the test. Push the test button. This will cause the reset button to pop out which means that the protected circuits have been disconnected. Push the reset button back in until a click is heard. This will reactivate the protected circuit. If the GFCI is working properly the reset button will remain in the "IN" position.

Notes

Heart Inverter/Converter (Optional)

When 120 volt power is not available, either from the power cord or the generator, the optional Heart Inverter/Converter may be used, if installed. The control panel for the inverter is located above or near the entrance door. Once turned on, the inverter transforms 12 volt power to 120 volt power for the operation of lights, appliances, televisions, etc. The 120 volt power that is generated from the inverter is routed to the electrical sub-panel located next to the main breaker box in the cabinet above the bed. The breakers in the sub-panel are labeled to explain where the 120 volt power is routed. It generally supplies power to the microwave, kitchen, bath, and bedroom lighting and receptacles. The inverter is equipped with an automatic transfer switch. This allows automatic switching from inverter to converter. When you are connected to an outside power source or running the generator, the converter (in the inverter) will automatically switch on to charge the 12 volt batteries. For more detailed information consult the manufacturer Owner's Manual located in the Owner Information Package.

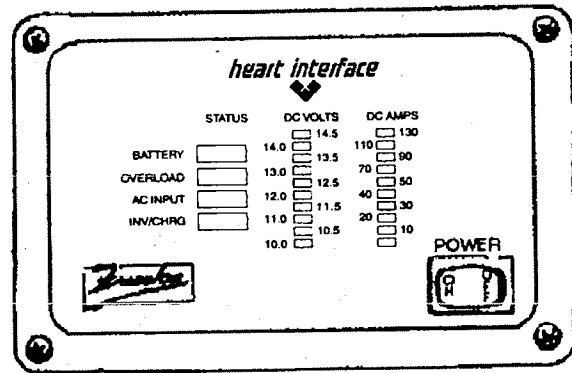

Daytime Running Lights

This unit is equipped with the daytime headlight system. This feature will cause the headlights to activate automatically when the ignition is on. The headlights are on, but dimmer than normal. At dusk, the driver is required to turn the headlights on by using the headlight switch. This will allow the driver to control the bright or dim capabilities of the headlights.

Spotlight (Optional)

The optional spotlight may be installed on the roof of this unit and is controlled by the toggle switch on the dash. The light can be turned on or off and can be moved in various directions.

ICC Flasher

On the dash you will find a switch labeled "ICC Flasher." This switch is a momentary type of switch. This means it is only active while the switch is being pressed. It enables the driver to communicate with other traffic by flashing the clearance and side lights of the coach. If the lights are on, it will turn them off. If the lights are off, it will turn them on.

Generator

The generator is located in a compartment in front of the motor home. It is mounted on slides for easy access. The slides for the generator must be unlocked before free movement is allowed. Prior to starting or stopping the generator, make sure all of the 120 volt appliances

are turned off. After the generator has started, wait until the transfer switch has connected before turning on any of the appliances. The generator can be started from either the remote start switch located on the dash or directly at the generator itself. The hour meter installed on the generator calculates the number of running hours of the generator motor. This is used for maintenance schedules.

CAUTION

Failure to turn off the 120 volt appliances when starting or stopping the generator may damage the transfer switch and/or electrical appliances.

Consult the manufacturer owner's manual for detailed operating instructions.

Automatic Transfer Switch

Your unit is equipped with an automatic transfer switch. When the generator is turned on, this switch automatically transfers from shore power to generator power. There will be a slight delay between the start of the generator and the electrical connection. This delay allows the generator to reach normal operating speed without needing to supply a required load. When the unit is plugged into the outside power source, a click will be heard in the transfer switch box. The sound is normal and indicates that the unit is changing over to the outside power source.

Wiring Connector

Standard on all Newmar motor homes is the car towing hitch. This allows the consumer the capability of towing their passenger car while traveling. Also installed with the hitch is the wiring pigtail to connect tail lights, brake lights, turn lights, etc. of the towed vehicle with that of the motor home. The pigtail used is the standard seven-pin connector. The color scheme for the pigtail is as follows:

Left Turn SignalRed	ClearanceGreen	ChargeBlack
Right Turn SignalBrown	GroundWhite	BrakesBlue
	Back Up LightsYellow	

Below is the diagram of both the trailer and motor home side of the pigtail. As stated above, this is a standard seven-pin pigtail.

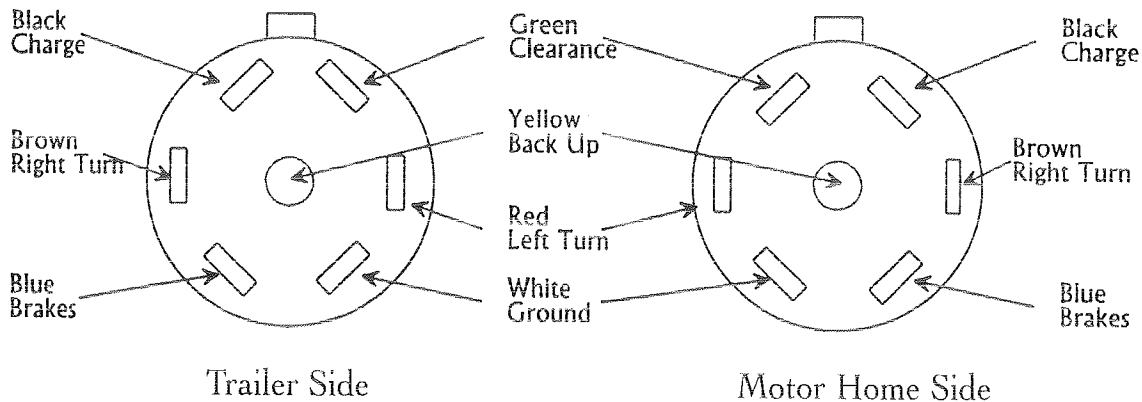

RESETTABLE BREAKERS

The resettable breakers are located within 18 inches of the source of power. This is the converter and the battery. (Figure 1)

When either of the breakers are shut down they must be manually reset.

To find the breakers, follow the line from the battery or converter approximately 18 inches.

This may lead to a junction box or to a cabinet inside the unit or similar location.

Manually reset the breaker as shown at right in Figure 2.

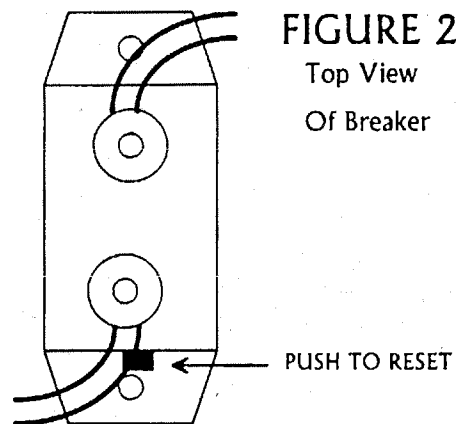
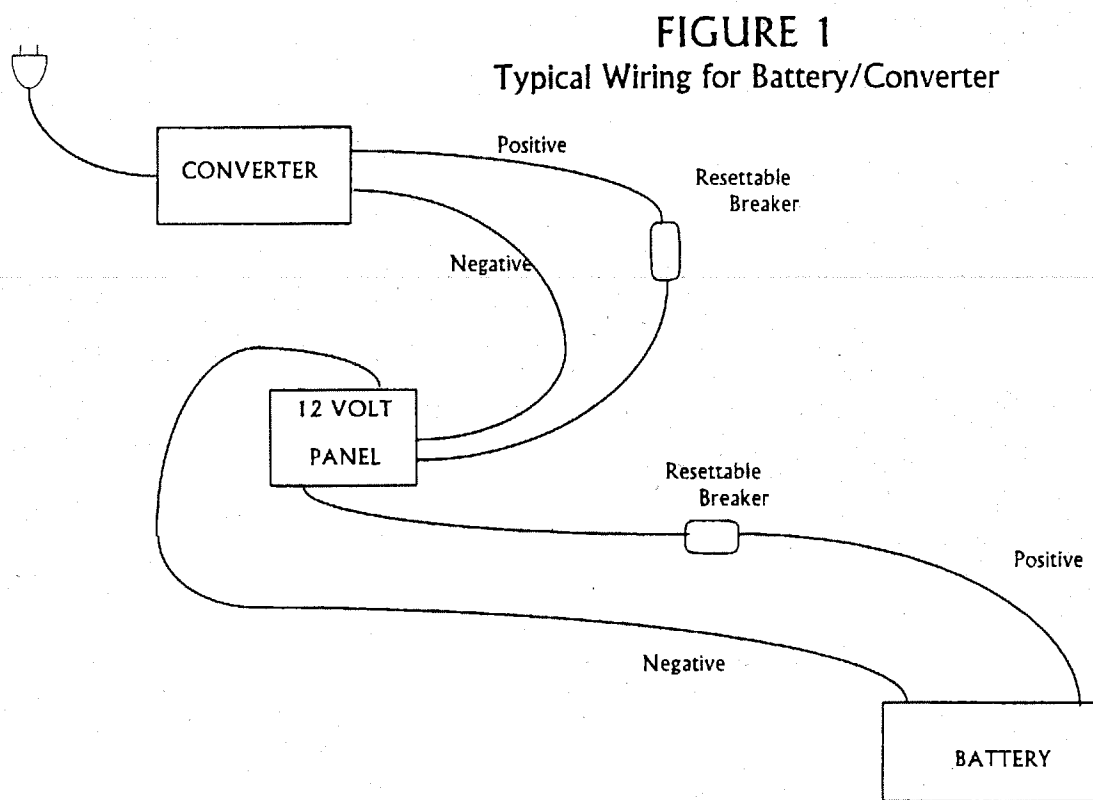

FIGURE 2
Top View
Of Breaker



CHAPTER 8

SLIDE OUT FEATURES

Table of Contents

General Instructions	8 - 1
Extending	8 - 2
Retracting	8 - 2
Manual Operation	8 - 2
Operating Precautions	8 - 3

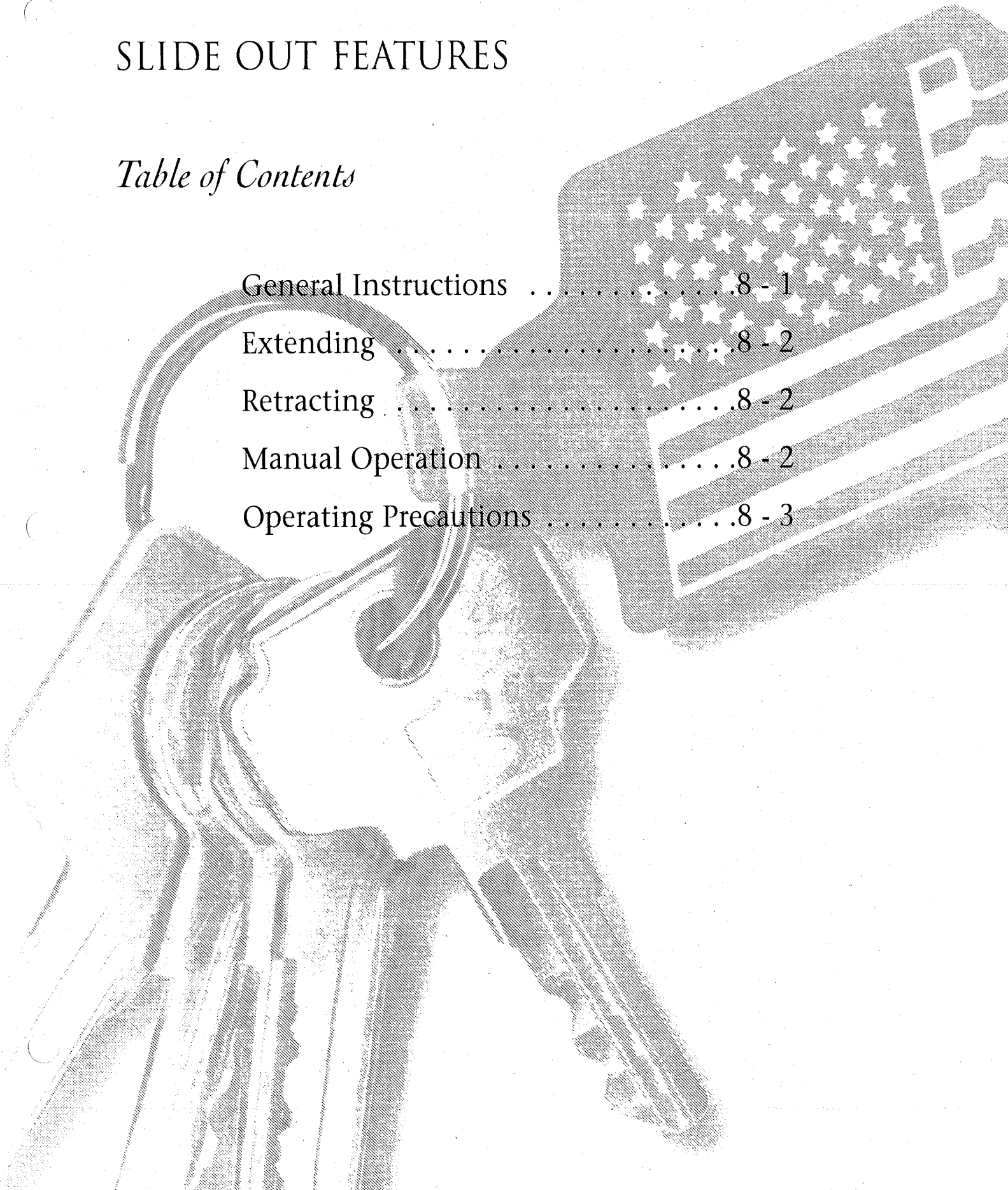



WARNING

READ THE FOLLOWING SLIDE OUT ROOM INSTRUCTIONS BEFORE ACTIVATING THE SWITCH.

CAUTION

The leveling jacks must be extended and the unit level before operating the slide out.

GENERAL INSTRUCTIONS

IMPORTANT

The slide out room should be inspected for alignment every six (6) months. If alignment is necessary, have the room adjusted.

1. The slide out room can be stopped at any time by activating the slide out switch. The room will reverse directions each time the switch is activated.
2. If the slide out room stops before reaching the full "OUT" or "IN" position, the slide out controller may need adjustment.
3. To adjust the slide out controller, turn the adjustment screw clockwise to increase the power and counter-clockwise to decrease the power.

CAUTION

Move the adjustment screw in small increments. Try moving the slide out room again. Use caution. There is a potential for component or structural damage if the screw is adjusted too high.

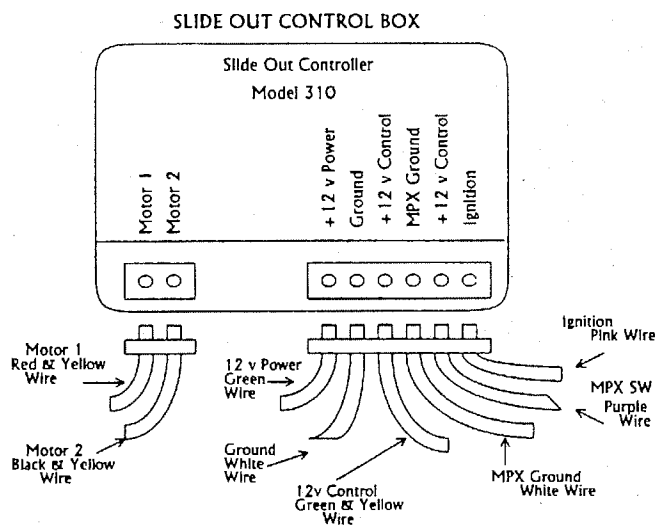

IMPORTANT

This screw does not adjust the slide out room speed. It sets the amount of power required to move the room against the mechanical stops.

Extending the Slide Out Room

1. The windows on the end of the slide out room must be closed before moving the room in either direction.
2. Before extending or retracting the room, look for and remove any obstructions.
3. Move the driver's chair forward before moving the slide out room in either direction.
4. Disengage the lock arms by pulling down on the center of the arm using the lock arm release tool, as required.
5. Activate the slide out switch. Once fully extended, the room will automatically stop. The indicator light will be lit while the room is traveling.



Retracting the Slide Out Room

1. Activate the slide out switch. When fully retracted, the room will automatically stop. The indicator light will be lit while the room is traveling.
2. Before moving the coach, engage the lock arms by pushing the arm up into the locked position using the lock arm tool, as required.

Manual Extension and Retraction

1. Access must be gained to the TRANTORQUE bushing coupling at the end of the slide out gear motor.
2. Using the factory supplied $\frac{1}{2}$ " drive - $1\frac{1}{4}$ " open end crows foot wrench and a user supplied $\frac{1}{2}$ " drive ratchet wrench, loosen the $1\frac{1}{4}$ " nut. This will require approximately $1\frac{1}{2}$ turns. The nut is a standard right hand thread. After the initial release the nut will turn for a partial turn, then will release again as you turn the wrench. This second release is required to loosen the TRANTORQUE bushing from the shaft.

In Chapter 15 you will find a diagram of the slide out mechanism.

The Slide Out Room May Be Moved By Two Methods

1. With the proper amount of help, two people minimum, the slide out room can be pushed the full length of its travel in either direction.
2. The $1\frac{1}{4}$ " crows foot wrench and the $\frac{1}{2}$ " drive ratchet wrench can be used on the short $1\frac{1}{4}$ " square section of the cross shaft. Moving the slide out with this method may take more than one person.

CHAPTER 9

EXTERIOR FEATURES

Table of Contents

Hitch	9 - 1
Exterior Sides	9 - 1
Roof	9 - 1
Jacks	9 - 1
Electric Steps	9 - 3
Mirrors	9 - 3



120



EXTERIOR FEATURES

Hitch

On the rear of this unit you will find a 4,000 pound car towing hitch. This is installed for towing passenger cars to be used when the vehicle is parked. The wire connector installed with this hitch is a standard seven-pin connector. For more information on the connector, please see Chapter 7 of this guide.

Exterior Sides

The sides of this unit are constructed of gel-coated fiberglass. To add to this feature, the front and rear end caps are also gel-coated fiberglass. Clean the fiberglass material with a mild cleanser and warm water. Use only soft cloths. Using stiff bristle brushes may cause scratches in the fiberglass surface.

Roof

The standard unit is manufactured with a rubber roof. An option is to have the roof and radius top wrap gel-coated fiberglass. This option would complement the sides and front and rear end caps. On this model, the roof rack and ladder are standard features.

Jacks

WARNING

If the vehicle is equipped with a slide out, do NOT operate any room extension until the leveling and stabilizing procedure is complete. Do NOT retract the leveling system until the slide out room has been retracted. NEVER operate the leveling system when the slide out is extended.

This unit is equipped with hydraulic leveling jacks with automatic control. These jacks can be operated by the fully automatic method or the manual method. In either case, the jacks work in pairs: front, right side, left side, and rear. Before extending, using either method, the engine must be off, the ignition switch must be in the "ACC" position, and the transmission must be in park. The park brake needs to be set, either manually or automatically.

CAUTION

Do not lift the wheels off the ground when leveling. The unit can roll forward or backward when supported only by the jacks.

IMPORTANT

If the hand/auto park brake is not set, the "NOT IN PARK/BRAKE" light will come on when the "ON" button is pushed. The panel will turn on, but the system will not operate.

Automatic Method

To extend, press the "HYD" button on the HWH control panel. The indicator light will illuminate. By pressing the "HYD" button a second time, the indicator light will flash. The coach will level automatically. Once leveled, the system will shut off. To retract the jacks, start the engine and allow the air pressure to build. Press the "HYD" button once. The indicator light will illuminate. Press the store button and the store indicator light will flash as the jacks retract. Once the travel light is on, the coach may be moved. Again, the system will automatically shut off. It is recommended to visually verify that the jacks have raised and are not on the ground prior to moving the vehicle.

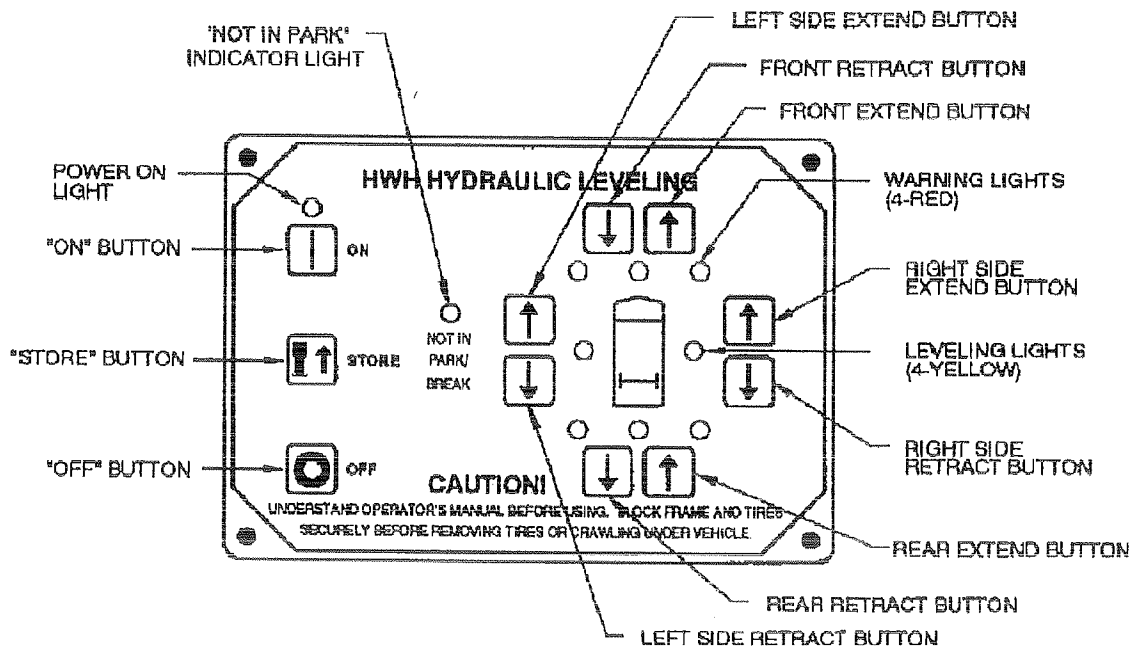

Manual Method

To extend, press the "HYD" button on the HWH control panel. The indicator light will illuminate. Press the "DUMP" button and continue holding the button until the air is dumped from the system. On the right hand portion of the touch panel note the outline of the coach and the various up and down arrows touch buttons. Press the respective up arrow button to raise the respective side or end of the coach. A yellow light to the front, side, or rear of the coach outline indicates which side or end is low. The down arrow buttons will lower the coach.

Electric Steps

This unit is equipped with electric entrance door steps. When the power switch for the steps is in the on position, simply open the door and the steps will open. Detailed operation for the electrical entrance door steps is as follows:

1. Turn the step power switch on.
2. Close the door. The step should retract and lock into the up position.
3. Open the door. The step should extend and lock into the down position.
4. Turn the step power switch off. The step should remain in the extended position with the understep light off when the door is closed. Turning off the power with the step retracted will hold the step in a retracted position as well.
5. With the step extended, turn the step power switch off and close the entrance door. Turn the vehicle ignition on. The ignition override system will go into effect, and the step will automatically retract.

CAUTION

If the vehicle is driven with the step in the extended position, there is the possibility of causing major damage to both the step and the vehicle.

6. Turn the vehicle ignition off and open the door. The step will extend and lock in the down position.

CAUTION

If the door is opened and closed without allowing the step to fully extend and lock in the 'DOWN' position, the step will retract and lock in the 'UP' position. When the door is reopened, the step will not extend. The power switch must be turned on for the step to extend.

7. This feature is only operative the first time that door is opened after the vehicle ignition is turned off. When the ignition is on, the step will always activate with the door movement, regardless of the step power switch position.

MIRRORS

This vehicle is equipped with remote control mirrors. Always adjust the mirrors for maximum rear visibility prior to driving. Make sure the seat is positioned for proper vehicle control. The mirrors are adjusted using a multiple directional switch located on the driver's door. Select the mirror to be adjusted by pointing the arrow in the direction of that mirror. Move the control in the direction of movement desired to obtain the best view. The adjustment control moves the top half of both mirrors.

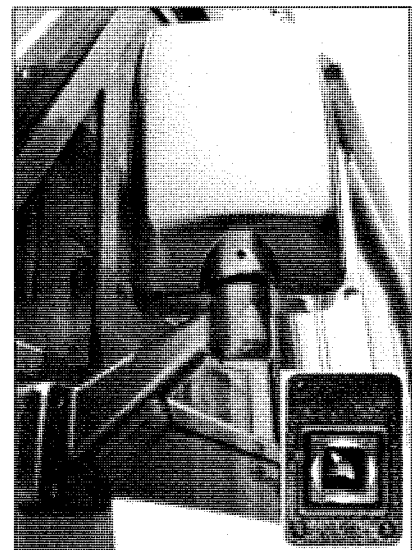

CHAPTER 10

INTERIOR FEATURES

Table of Contents

Bedsread	10 - 1
Flooring	10 - 1
Ceiling	10 - 1
Window Treatment	10 - 1

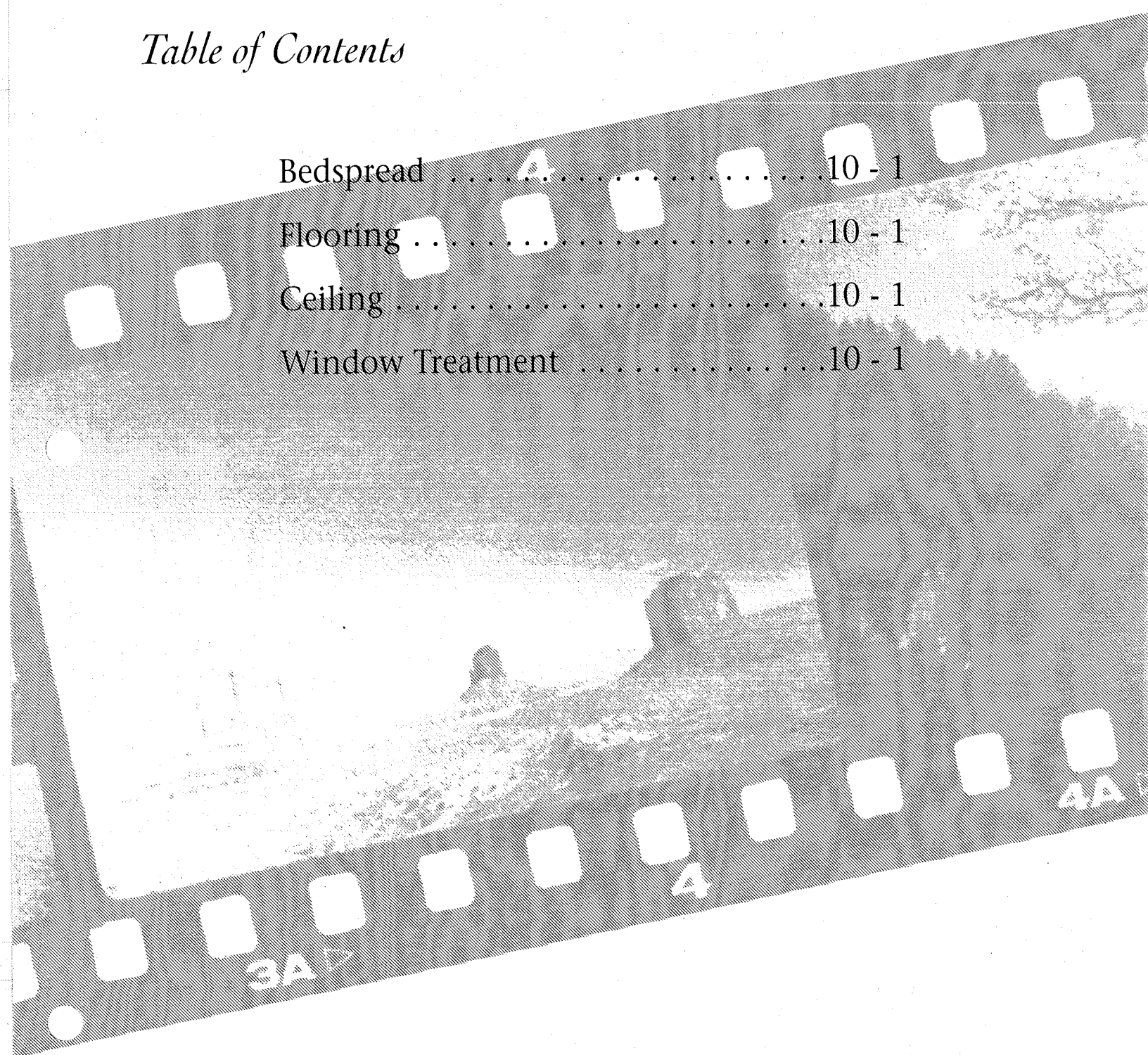



INTERIOR FEATURES

Bedsread

All units have a decor matching bedsread enclosed as part of the standard package. The recommended cleaning instructions for this spread are Dry Clean Only. The materials that make up the spread may have been treated, and dry cleaning will preserve this treatment.

Flooring

The floor covering for the living room, bedroom, and the bathroom of the unit is carpet. In the Owner's Package you will find literature supplied by the carpet manufacturer. This information will be helpful in maintaining and extending the life of the carpet. Please refer to this information for the carpet care and cleaning instructions. The floor covering for the kitchen is the popular hardwood plank flooring. An optional floor covering for the kitchen and bath area is vinyl linoleum. An additional option in the bath is the ceramic tile flooring. To clean any of these floor treatments, use a mild soap with warm water and a soft cloth.

Ceiling

The ceiling in this unit is covered with a woven soft touch ceiling covering. The recommended cleaning instructions are to have the ceiling professionally dry cleaned.

Window Treatment

The window treatment throughout this unit, except in the kitchen, is pleated day/night soft shades. These shades have two sections. The first section visible when closing the shade is the "DAY" section. This material is translucent. Sunlight passes easily through the material into the unit. The second visible section is the "NIGHT" section. This material is a heavier, more opaque material. Very little to no light passes through it. It is generally used in the evening or when more privacy is desired. The kitchen window is equipped with a mini-blind.

Notes

CHAPTER 11

PLUMBING & BATH FEATURES

Table of Contents

Kitchen Sink	11 - 1
Bath Sink, Shower & Accessories	11 - 1
Monitor Panel	11 - 1
Monitor Panel Calibration	11 - 1
Water Pump	11 - 2
City Water Hook-Up	11 - 2
Fresh Water Tank Fill	11 - 3
Sanitizing	11 - 3
Drink Dispenser with Water Filter	11 - 4
Water Heater By-Pass	11 - 4
Fresh Water Lines	11 - 5
Waste Water System	11 - 5
Toilet	11 - 5
P-Traps	11 - 6
Black Water Holding Tank	11 - 6
Gray Water Holding Tank	11 - 6
Waste Water Disposal	11 - 6
Camping with Sewer Hook-Up	11 - 7
No Fuss Flush	11 - 8



11



FRESH WATER SYSTEM

Kitchen Sink

The kitchen sink installed is a double bowl stainless steel sink. The unit has two sink covers to provide additional counter space when the sink is not in use. Stainless sinks do not rust or chip. Cleaning care consists of washing with mild detergents and a soft cloth. Avoid using "S.O.S." type cleaning pads because they may scratch the stainless steel surface. The faucet in the kitchen is an 8" chrome single handle faucet.

Bath Sink, Shower & Accessories

The sink in the bathroom is vacuum formed durable white plastic. Use care when cleaning to prevent scratching the surface. The bathroom accessories include two towel bars, a tissue holder, and a robe hook. These accessories are shipped loose in order for the dealer to install according to the dealer or customer's specification. The faucet in the bathroom is decor matching with a white dual handle faucet. The shower installed is a combination tub and shower surround with enclosure. The white tub faucet with shower head, hose, and bracket are decor coordinates with the sink faucet.

Monitor Panel

The monitor panel allows you to check the approximate levels in the fresh, gray, and black water holding tanks, as well as the battery condition. The monitor panel is generally located above or near the entrance door. Simply press the button of the item to check its status. The empty indicator light will always light when the button is pressed. If the tank is full, all of the lights will be on. Lights are sequential and indicate the level in approximately $\frac{1}{4}$ tank increments. For example: If the tank selected is approximately $\frac{1}{2}$ -full, then the indicator lights E, $\frac{1}{4}$, and $\frac{1}{2}$ will be lit. On the right hand side of the monitor panel is the water pump switch. This switch controls the power going to the water pump, turning it either on or off.

Monitor Panel Calibration

The monitor panel comes to you factory calibrated for accuracy and should not need to be adjusted. In the event that the system does not read accurately, then re-calibration may be necessary. The procedure for re-calibration is simple: First, fill the tank to be re-calibrated. Second, using the adjustment tool enclosed in the Owner's Package (or any small flat-bladed screw driver), simultaneously push the button for that tank and rotate the adjustment screw located above the button and behind the face plate counter-clockwise until some of the lights turn off in sequence. Then slowly rotate the adjustment screw clockwise until the full light is completely on. Repeat this procedure as necessary for the remaining tanks. The system is now calibrated properly.

Water Pump

The water pump is self-priming and totally automatic, operating on demand whenever water is required. The water pump is used to pressurize the fresh water system when the unit is not connected to city water. To start the pump follow these instructions:

1. Fill or partially fill the fresh water supply tank.
2. Open the kitchen and bathroom faucets.
3. Turn the water pump switch on and allow the water to fill the water line and the hot water heater.
4. Close each faucet after it delivers a steady stream of water (close the cold water first). Leave the hot water faucets on until they also deliver a steady stream of water. This will ensure that the water heater is filled with water.
5. The water pump should stop running once all faucets are closed.
6. The pump is now ready for automatic operation. The pump will run when a faucet is opened and stop when a faucet is closed.
7. Never allow the pump to run for long periods of time without water in the supply tank. Pump damage or blown fuses may result.

If water doesn't flow when a faucet is turned on while using the demand system, use the following trouble shooting chart:

SITUATION	SOLUTION
Pump running - no water	1. Fill tank 2. Clear the water line to the pump
Pump doesn't run	1. Check the pump switch 2. Check the 12 volt fuses 3. Check the electrical connections 4. Check the battery

All of the water should be drained from the fresh water system when the unit is not in use for more than one week. For more detailed information regarding the water pump, refer to the water pump manufacturer's brochure in your Owner's Package.

City Water Hook-Up

When connecting your unit to city water, be certain to use a water hose manufactured and labeled for potable water. This will ensure that the hose will not alter the taste of the water. To hook the city water supply to the unit, connect one end of the hose to the city water supply. This will usually be a faucet or valve similar to your garden hose valve at home.

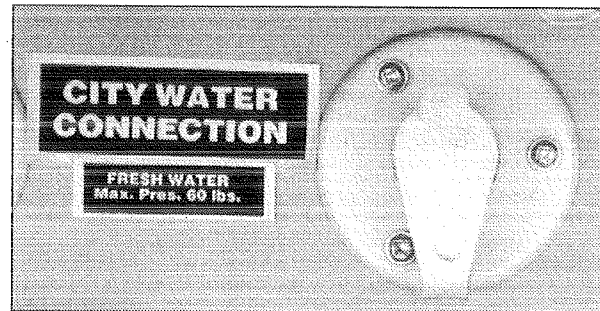

Turn the city water supply on for a few seconds in order to clear the line. Once the hose has been flushed, turn the supply off. Connect the other end of the hose to the city water connections. Turn on the water supply and open all of the faucets to clear the air from the lines in the unit. Once air pockets have been purged from the water lines and water flows freely, close all of the faucets. The city water supply is under pressure, therefore the water pump is not necessary when connected to city water. Once the city water fill valve is opened, water is supplied to the fresh water system including the hot water heater, faucets, and stool. To disconnect from the city water supply, close the valve and remove the hose from the city water supply. Disconnect the hose from the city water connection and store the hose in the water compartment.

Fresh Water Tank Fill

The fresh water tank is filled from the city water hook-up. The valve located in the service compartment near the water hook-up determines whether the city water is going through the water system or into the fresh water tank. An additional way to fill the fresh water tank is with the winterizing intake hose placed in a bucket of water (See Chapter 14). Since there is not an automatic shut-off for the fresh water tank fill, check the level from the monitor panel while filling the unit. The excess water will be vented from an overflow vent pipe onto the ground when the tank capacity has been reached. This pipe is installed in the fresh water tank to prevent tank rupture from overflowing. All of the water should be drained from the fresh water system when the unit is not in use for more than one week. Whenever possible, drain the fresh water tank before traveling. Water in the tank will reduce the carrying capacity of the unit.

SANITIZING

To assure complete disinfecting of your fresh water system, it is recommended that the following procedure be followed on a new system, on one that has not been used for a length of time, or one that may have become contaminated. This procedure is also recommended before long periods of storage, such as over the winter months:

1. Drain the fresh water tank by opening the drain valves. There is one valve per water tank. All of the faucets should be in the closed or off position.
2. Prepare a chlorine solution using one gallon of water and $\frac{1}{4}$ cup of chlorine bleach (5% sodium hypo-chlorite solution). Prepare enough of the chlorine solution to administer one gallon of solution for every 15 gallons of tank capacity. For sanitizing this unit, prepare $4\frac{1}{2}$ gallons of the chlorine solution. This mixture puts a 50 PPM (parts per million) residual chlorine concentration in the water system that will act as a quick kill dosage for harmful bacteria, viruses and slime forming organisms. Concentrations higher than 50 PPM may damage the water lines and/or tank.
3. Once the fresh water tank is empty, close the drain valves on the water tank.
4. Pump the chlorine solution into the tank. This is done by placing the winterizing hose into the chlorine solution. Close the valve from the fresh water tank to the pump and open the valve from the solution to the pump. Turn the tank fill valve from city water to tank fill. Turn on the water pump until all of the solution is pumped into the fresh water tank.

5. Turn off the water pump. Close the valve to the solution. Open the valve from the tank to the water pump. Fill the water tank with the city water tank fill (or by using the same method as was used to put the sanitizing solution into the tank). Remove the water filter (from the drink dispenser faucet, if installed) and install the by-pass pipe to allow the sanitizing solution access to the faucet. Open each faucet in turn including the kitchen faucet, bath faucet, inside and outside shower, turning on both the hot and cold, and flushing the stool until all of the air has been purged from the pipes and the water runs freely. The entire system will then be filled with the sanitizing solution.
6. Allow the 50 PPM disinfecting solution to stand in the system at least four hours.
7. Drain the system and flush with fresh water. The water system needs to be flushed with clean water repeatedly, if necessary, until there is no chlorine taste or smell left in the system. To remove any excessive chlorine taste or odor that might remain, prepare a solution of one quart vinegar to five gallons of water. Allow this solution to agitate in the tank for several days by vehicle motion. Drain the solution and refill the tank with clean water.

Drink Dispenser with Water Filter

Before disinfecting the fresh water system, remove the water filter and install the by-pass pipe to allow water access to the drink dispenser faucet. The water filter is located under the kitchen sink. The filter will remove chlorine, dirt, and other matter. It will also eliminate most phenol (or similar) odors and tastes while delivering sparkling, taste free water for drinking and cooking. The filter is connected only to the cold water line that is attached to the drink faucet. The filter is not guaranteed to remove the tastes and odors of iron and sulfur. To remove these tastes you will need to chlorinate the water. Replacement filters are available that will filter iron and sulfur. Ask your dealer or RV supply center about acquiring an iron and sulfur filter. If you are traveling in an area where the water has a high iron and sulfur content, then add 1 tablespoon of chlorine bleach to every 10 gallons of water in your tank. This will precipitate the iron or sulfur so that the filter can remove it. If you are at a site where the unit is hooked up to city water, you will not be able to chlorinate the system because the water flows straight to your faucets and not through the fresh water tank. Filters should be changed every 6 - 12 months depending on the quality and quantity of water that is used in your unit.

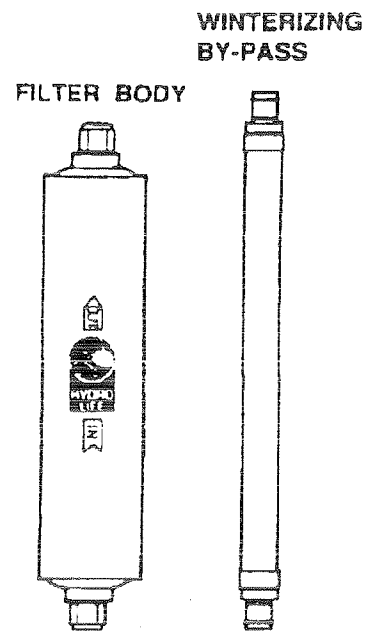

Water Heater By-Pass System

The water heater by-pass valve is located in an outside compartment near the water heater. By closing the water heater supply valve and opening the by-pass valve you can divert water away from the water heater. This is done when winterizing your unit. Using the by-pass will keep antifreeze out of the water heater when winterizing the system. Draining the water heater during winterizing is a MUST.

Fresh Water Lines

Vibration and flexing during traveling can cause pipes and fittings to work loose. Check all of the plumbing connections for leaks on a yearly basis. If the water pump runs when all faucets are turned off, check for a leak. Be sure the drain valves are closed. Connections at the kitchen and bathroom faucets normally seal with hand tightening and a half turn with a wrench. If a fitting leak persists, disconnect it completely and check for mineral deposits or foreign material on the sealing surfaces. Clean the surfaces thoroughly and reinstall the fitting. Take the coach to an authorized service center for repairs if the system continues to leak. Follow the winterizing instructions given in Chapter 14 to reduce the risk of leaks caused by cracks from freezing pipes. Freezing damage can be extensive and expensive.

WASTE WATER SYSTEM

General Information

The waste drainage system was designed to provide adequate and safe storage and/or disposal of waste materials. All of the materials used in the making of this system are tested by a nationally recognized testing laboratory. The drainage system uses plastic piping and fittings connected to the sinks, toilet, and holding tanks. This provides for their drainage to an outside termination. The unit should be reasonably level for best operation of the system. There are two separate waste systems. The gray water system is for waste water from the sinks and shower. The black water system is generally for sewage waste from the stool. Each tank has its own control valve, and both tanks drain through the sewer drain hose.

Toilet

The stool operates with water from either the fresh water tank with the water pump on or the city water supply. Before using the stool, add water to the bottom of the tank. Refer to the 'BLACK WATER TANK' instructions in this chapter. The stool flushes waste directly into the black water holding tank. The stool uses high velocity water injection to produce a swirl effect in the bowl. The greatest problem that causes stool solids to build up in the holding tank is lack of liquids. When using your stool, it is wise to fill the stool 3/4 full of water. This will help to wash the solids away from directly below the stool and to ensure complete dumping of the holding tank. To add water to the stool bowl, lift up on the lever. To flush the stool, push down on the lever until the water swirls.

The stool requires little maintenance. Use an approved non-abrasive cleaner to clean the bowl. Spraying the bowl sealing blade with a silicone spray will retain the original smooth operating condition.

Check the complete instruction and trouble shooting guide in the stool manufacturer's Owner's Manual provided in the Owner's Package.

P-Traps

Each of the sink drains, the shower drain, and the washing machine drain (if equipped) has a water trap (P-Trap) to prevent holding tank odors from entering the coach. These traps must have water in them in order to trap the odors. While traveling, the water may splash out of the sink and shower drains. While stored, the water may evaporate allowing an odor to enter the coach. If this occurs, run water from the faucet into the drain, allowing water to fill the trap.

Black Water Holding Tank

The black water, or sewage, holding tank is located directly beneath the toilet. Before using the stool, you will need to treat the tank with water that is mixed with an odor controlling chemical. These chemicals are readily available at any RV supply store. Be careful not to spill the chemical on your hands, clothing, or the carpet because it may cause a permanent stain. Pull the toilet levers forward to allow the chemical to mix with the toilet water. Continue pulling the toilet levers until at least one inch of solution is directly under the toilet. Release the levers, and the waste tank is ready for use.

CAUTION

Use only approved RV odor controlling chemicals in the holding tanks. Products containing ammonia and petroleum will damage the ABS plastic holding tanks and seals.

Gray Water Holding Tank

The gray water holding tank is located in the underbelly of the unit. It is primarily used for the drainage from the kitchen and bath sinks and the shower.

Waste Water Disposal

Both of the holding tanks terminate in a valve arrangement that permits draining each tank separately or together. It is recommended to drain the black water tank before the gray water tank. This will allow the water from the gray tank to wash the black water residue from the drain lines and hose. The valves that open to release the water are called gate valves. The blade that closed the opening in the sewer drain pipes is connected to the T-handle to release the contents of the tank(s) when pulled. The sewer line must be securely capped during self-containment use to prevent leakage of waste material onto the ground or pavement. Do not pull the holding tank gate valve open when the protective cap is installed on the pipe. Always drain the tank into an acceptable sewer inlet or dump station.

WARNING

Holding tanks are an enclosed sewer system and must be drained into an approved dump station. Both black and gray water holding tanks must be drained and rinsed thoroughly on a regular basis in order to prevent the accumulation of harmful or toxic materials.

Whenever possible, drain the holding tanks prior to traveling. The carrying capacity of your unit will be reduced if water is left in the black or gray tanks.

The holding tanks should only be drained when they are at least $\frac{3}{4}$ full. Doing this will provide sufficient water to allow the complete flushing of waste materials in the drain lines and hose. If the tanks are not $\frac{3}{4}$ full, add enough water to allow for sufficient flushing.

To empty the waste water tanks, connect the adapter to the drain hose. Use the adapter supplied with your unit. If the adapter is lost or broken, one can be purchased from any RV supply store. Once you have placed the adapter on the drain hose, it can remain there for the life of the hose. One end of the hose threads up through the hole in the bottom of the service compartment, and the other end of the hose feeds into the sewer at the dump station. Unscrew the cap off the drain. Connect the hose with the adapter in place to the drain fitting. Open the gate valve all the way by pulling on the T-handle. The tank will start to drain as soon as the T-handle is pulled. After you have drained the black water tank, immediately drain the gray water tank. Doing this helps to flush the black water from the sewage hose.

When both of the tanks are empty, flush them with a fresh water rinse before you close the valves. The gray tanks are easily flushed by pouring a couple of gallons of water into a sink drain. The drain outlet is engineered for quick release of the drain hose adapter. Always close the gate valves and secure the end cap to prevent leakage while in transit. After draining the black water tank, it is recommended to add a holding tank deodorant (such as Thetford Aqua-Kem) to help control the odor and break down the solids. Follow the instructions given on the holding tank deodorant package.

When using dump stations for draining the holding tanks, keep other travelers in mind. Practice good housekeeping. Leave the dump stations in good order. Above all, do not pollute.

Camping with Sewer Hook-Up

When camping at parks with sewer hook-up, it is important to keep the black water holding tank gate valve closed at all times, except when dumping. The gray tank can be kept open while hooked to a sewer connection but again, the black water tank must be kept closed. This is done so that an ample supply of liquid remains in the tank to provide a smooth flow through the gate and drain valve when dumping. Sufficient liquid in the tank causes a swirling action that should take any accumulated solid wastes with it. Accumulation of solid wastes in the black water tank can be avoided by keeping the gate valve closed when connected to the sewer hook-up. If the valve is left open, solid wastes may accumulate in the tank. This may eventually result in costly repairs. The gray tank valve needs to be in the open position when operating the optional washing machine.

CHAPTER 12

CONSTRUCTION FEATURES

Table of Contents

Construction Features	12 - 1
---------------------------------	--------

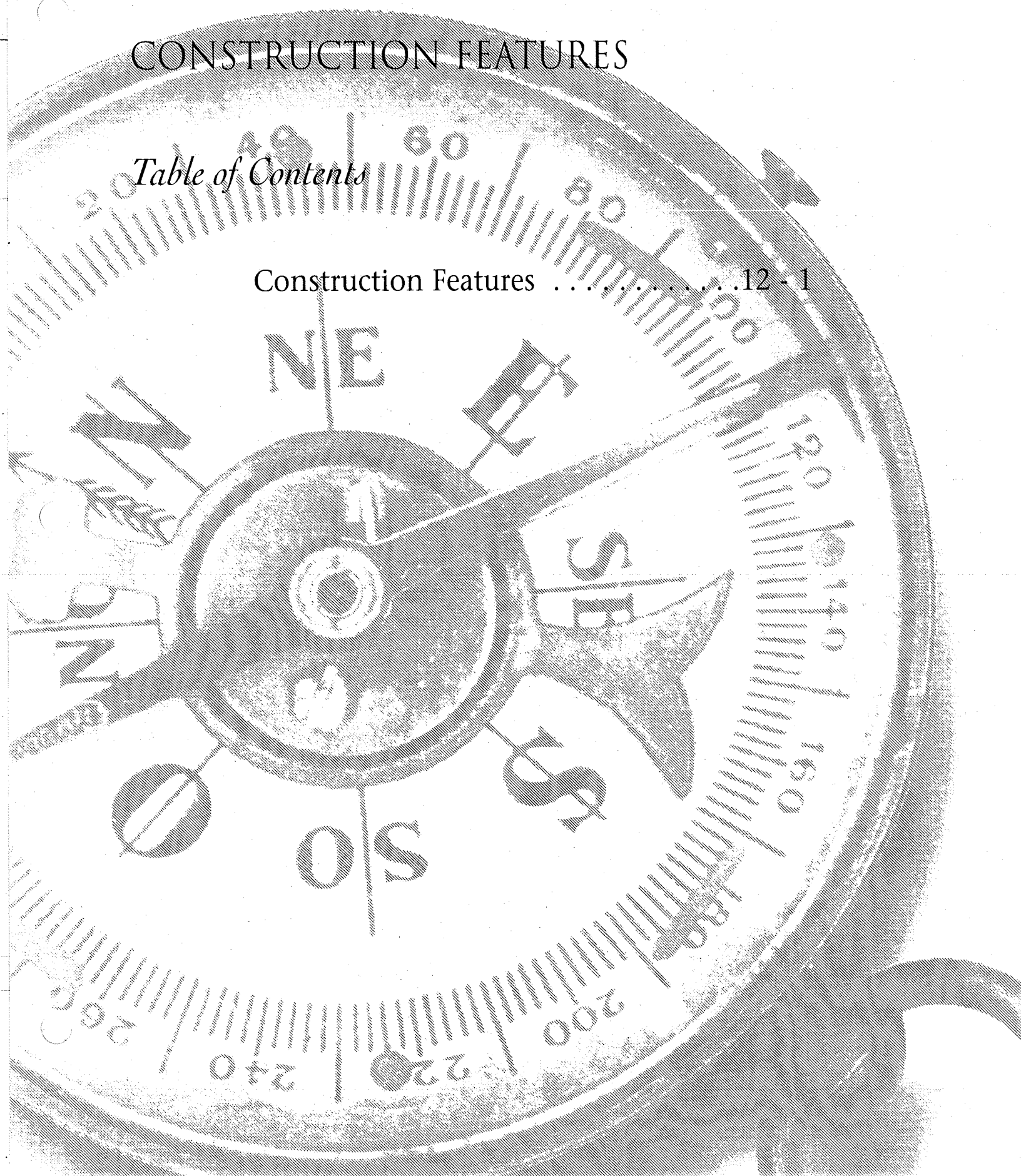

CONSTRUCTION FEATURES

The floor decking is constructed of durable $\frac{1}{32}$ " structure wood. The fiberglass insulation in the floor and sidewall is rated at R7, while the roof is rated R11.

On this model, each sidewall is constructed for strength and is well insulated for comfort. Welded for added strength the extruded aluminum sidewalls and roof are built with 16" on center framing to provide a strong and durable construction. The inside consists of $\frac{5}{8}$ " beaded foam that is laminated to kraft paper and covered by the interior paneling. A blanket of rolled insulation is added to the sidewalls, roof, and slide out to provide a greater efficiency and consistency of climate control. This will assist the furnace in the winter by keeping the warm in and the cold out. In the summer months it will assist the air conditioning by keeping the cool air in and the hot air out.

Below are examples of the framing and insulation similar to that in your unit.

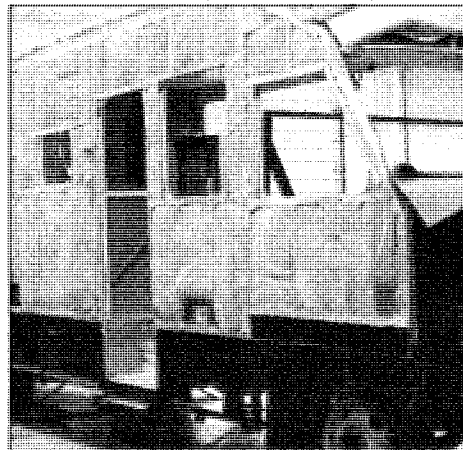
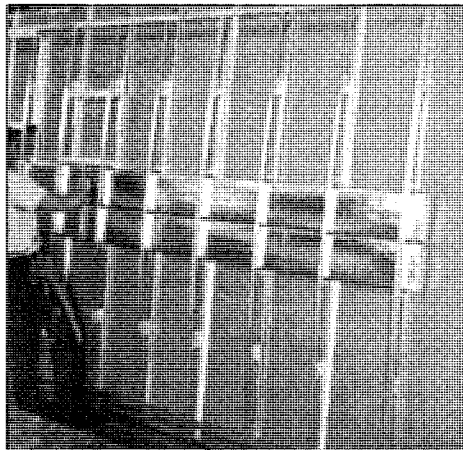
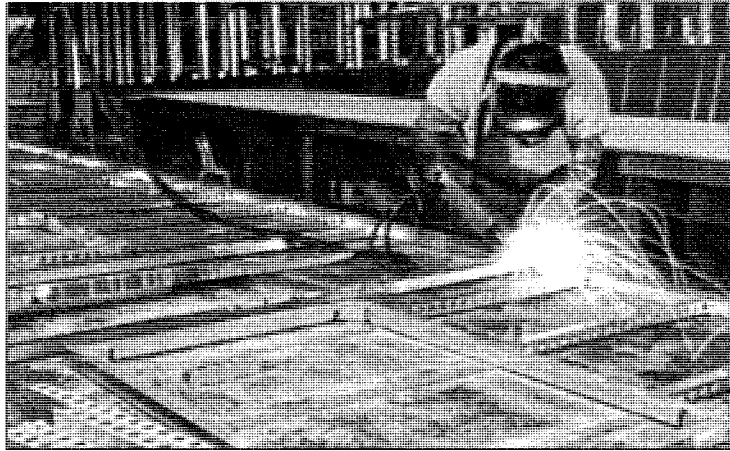
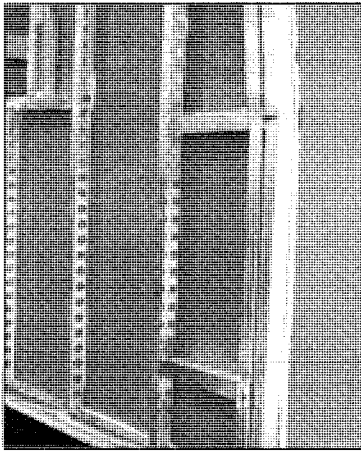

CHAPTER 13

WINDOWS, AWNINGS, VENTS & DOORS

Table of Contents

Windows	13 - 1
Awnings	13 - 2
Window Awnings	13 - 3
Vents	13 - 4
Doors	13 - 5

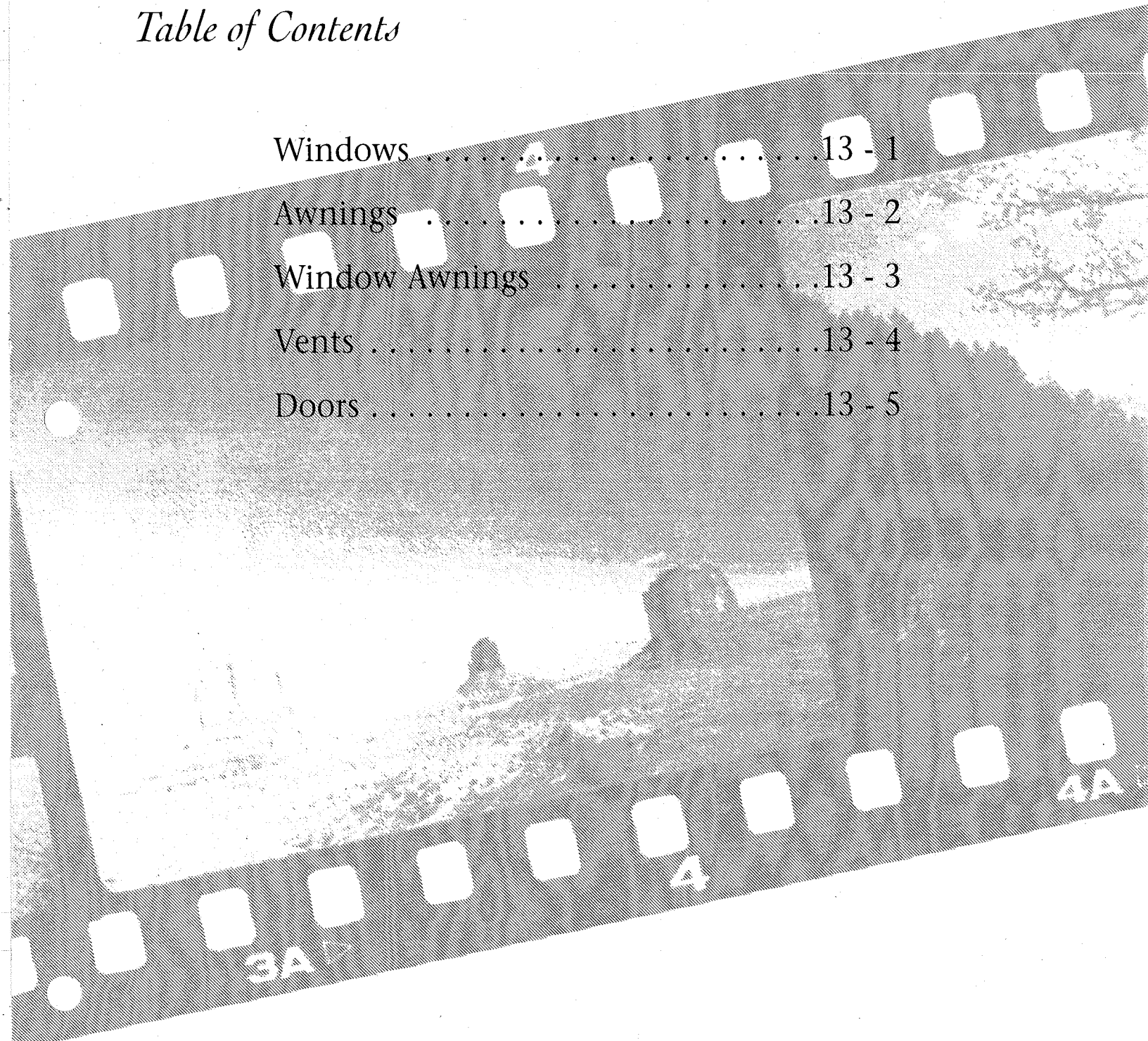



AWNINGS

Side Awning

The side awning is an available option on this unit. When installed, the side tension rafter can also be optioned. To operate, follow these instructions:

EXTENDING

1. Loosen the black adjustment lock knob behind each main arm. Flip the travel lock latches up.
2. Using the provided pull rod, reach up and pull the locking lever forward to release the awning.
3. Hook the rod into the loop of the pull strap and pull the awning all the way out.
4. Slide one rafter arm up until it snaps into place. Push down on the main arm to remove slack from the fabric, and tighten the black adjustment knob. Repeat on other side.
5. Slide the pull strap to the right end of the roller and wrap it around the main arm.
6. Pull up on the lift handle and raise the arm assembly to the desired height. Swing the handle in and allow the lock button to snap into one of the holes. Repeat on the other side.
7. Press the release lever at the bottom end of one main arm, pull the arm assembly outward to a vertical position, and readjust height. Repeat on the other side. Drive provided stakes through holes of each patio foot into the ground.
8. During rain, lower one end to allow water to flow off.

CAUTION

Whenever heavy or prolonged rain or wind is anticipated, or you will leave the awning unattended, it is best to close the awning. Damage as a result of weather is not covered by warranty.

RETRACTING

1. Pull the stakes from the ground, swing the arm toward the vehicle, and snap the patio foot into the bracket. Repeat on the other side.
2. Raise the lift handle to release the lock button. Lower the main arm to the stop plug. Swing the handle in to engage the lock button in a hole. Repeat on other side.
3. Loosen black adjustment knob, lift slider catch, and slide the rafter arm down to the bottom of the main arm. Leave the black adjustment knob loose. Repeat on other side.
4. Grasp the pull strap and pull toward you. Flip the locking lever to the ROLL UP position. Hold the awning in the down position until you are ready to roll up the awning.

CAUTION

The awning will try to roll up as soon as the locking lever is flipped to the "ROLL UP" position.

5. Slide the pull strap to the center and using it to control speed, allow the awning to return to the side of the vehicle. Allow the strap to wind diagonally to prevent a bulge in the fabric.
6. Tighten the black adjustment knob and flip the travel lock latch down. Repeat on other side. The awning is now ready for travel.

Window Awning (Optional)

Also optional for this unit are the matching A & E window awnings. To operate, follow these instructions.

EXTENDING

1. Grasp the loop on the pull strap and pull down to extend the awning. Then hook the loop onto the window strap hanger.

RETRACTING

1. Remove loop on the pull strap from the window strap hanger.

CAUTION

Do not release the strap as the window awning is under tension and may snap back against the vehicle.

2. Slowly allow the awning to roll back to the closed position by feeding the pull strap upwards and diagonally. This prevents the strap from building up and creating a bulge in the fabric.
3. The window awning is now ready for travel with no further locking required.

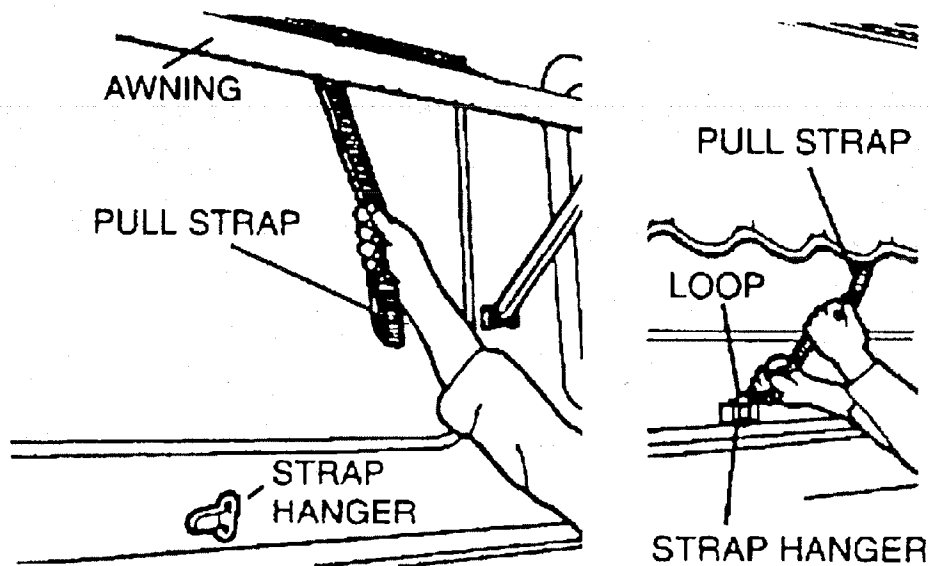

Vents

The standard vent in the kitchen is the 12 volt Fantastic Vent. This vent is equipped with a rain sensor on the roof hood. If the vent is open and it senses rain, it will automatically close. The vent is controlled by the wall thermostat. Once powered "ON" and the desired temperature is selected, the vent will run until the temperature is reached. When the temperature is reached, the vent will automatically shut off.

Optional on this unit is to have the Fantastic Vent ducted through the central air ducts. This would make it a central vent. This central vent would draw the air from the unit through the air conditioning warm air duct. This ducting feature would not alter the thermostat functions or the rain sensor feature.

The vent installed in the bathroom is also powered by 12 volt electricity. This vent is controlled by the ON/OFF switch located on the wall.

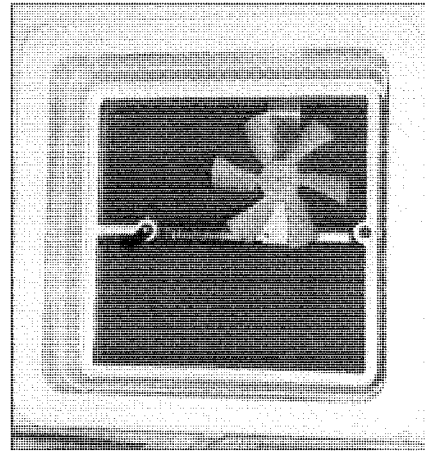

The installation of the skylight in the bathroom is a standard feature on this unit. In addition, a soft shade is installed on the skylight for privacy. To open or close the shade, simply move the bottom rail in the direction desired.

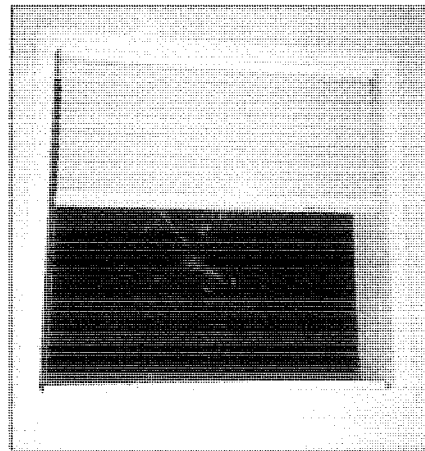

Notes

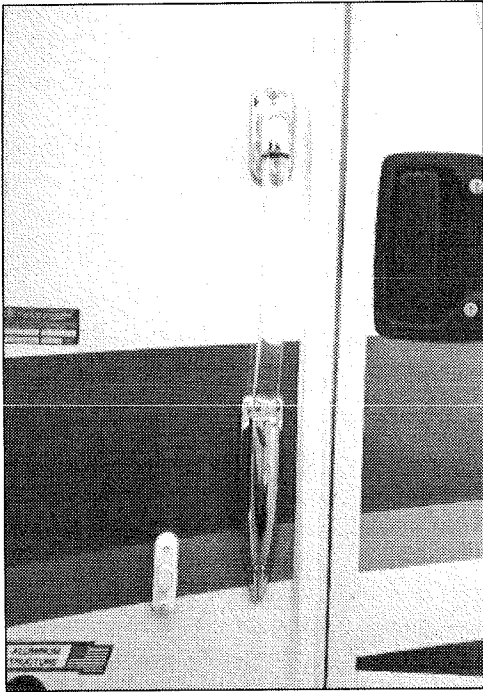

Doors

The entrance door is a radius door with a dead bolt lock for added security. When the door is opened fully, the door hinge will automatically hold the door open. To close the door from the open position, either the inside or outside handle must be released for the door to move. Next to the entrance door you will find the lighted acrylic assist handle. This handle may be used to assist anyone entering the unit. Next to the exterior handle, you will find the door bell button for the door bell. This door bell operates on four C cell batteries.



Optional for this unit is the installation of the driver's door. If the driver's door is installed, it is equipped with a power window for driver convenience.

Notes

CHAPTER 14

ROUTINE MAINTENANCE

Table of Contents

Washing	14 - 1
Waxing	14 - 1
Seals	14 - 2
Proper Sealants	14 - 2
Striping and Decals	14 - 2
Rubber Roof Care and Maintenance	14 - 3
Interior Care	14 - 3
Carpet	14 - 4
Fabrics	14 - 4
Walls and Ceiling	14 - 4
Dash	14 - 5
Woodwork	14 - 6
Counter Tops	14 - 6
Accessories	14 - 6
Detectors	14 - 6
Windows	14 - 6
Condensation	14 - 6
Routine Maintenance	14 - 8
Winterizing	14 - 9

EXTERIOR CARE

Washing

The exterior of your new camping vehicle is made of pre-finished aluminum and fiberglass. Frequent washings and thorough cleanings are recommended to prevent damage to the vehicle finish after exposure due to damaging salts, calcium chloride, road tar, tree sap, insects, and other foreign material. Never wash the vehicle in direct sunlight, while the vehicle is hot, or with hot water. Build up of mud and dirt under the body can cause damaging rust on steel parts and can add needless weight to the vehicle. Corrosive materials, such as those used for ice and snow removal and dust control, also accumulate on the underside of the vehicle. These materials should be removed by flushing the underbelly regularly with water, especially areas where mud and other foreign materials collect. The chance of corrosion can be minimized by frequent washings of the vehicle. When washing the vehicle, make certain that the undercarriage and the wheel wells are cleaned, as well as the exterior of the coach. Do not use strong soaps or detergents for washing the vehicle. Always use a mild soap in warm water, a commercially prepared product for automotive finishes, or your local car wash. Be careful when using a pressure-type washer to avoid loosening any exterior decals or sealants, etc. After washing, carefully inspect the caulking around window frames and vents and any other joints that may have separated. Recaulking, if necessary, is relatively simple.

IMPORTANT

Never use a strong solvent, such as lacquer thinner, or harsh abrasives, on any of the exterior painted surfaces.

Waxing

The exterior finish will require a routine waxing. When water will not bead and roll off a freshly washed vehicle, a new coat of wax is needed. Wax not only improves the appearance of the vehicle, but it also protects the finish against oxidation and corrosive materials. The recommended type of wax is one that is compatible with painted and gel-coated fiberglass finishes. Cleaning with a polishing compound will improve a dull or discolored finish.

IMPORTANT

When using a polishing compound that does not contain a wax preservative, reapplying a coat of hard wax after polishing is recommended.

Seals

The seals around doors, windows, vents, and external seams should also be checked at least twice a year. Check the roof seams once a year for cracking or peeling. If deterioration is noted, reseal the seams or seals with an approved sealant to prevent leaks. Your dealer can perform the resealing inspections and work for you. Your dealer is also able to inform you of the appropriate sealants to be used, if you prefer to do the job yourself. Sealants can be purchased from your Newmar Dealer.

Proper Sealants for Application

Plas-T-Cote	Metal or fiberglass roof
Surebond #SB-140	All Skylights
Carlisle #502-LSW Self Leveling Sealant	Rubber roof
Silicone Sealant	To cover butyl and other sealants, not to be used as the main sealant
Sikaflex-221	To seal or glue side walls, frame rails, etc.
Sikaflex-255 FC	To glue windshield and windshield gasket to cap
Neoprene Black Tape #P-8125	¼" x ½" to seal windows with clamp ring, baggage doors
Butyl Tape #5000-G	To seal screws in windows from outside Any place that screws are used
Parbond	To seal across tops of windows, etc. on exterior where silicone is not used
Dicor #710-SA Splice Cement	To splice rubber roofs

Striping and Decals

The striping and decals on your vehicle require very little maintenance. Treat these as you would any painted surface on your vehicle. Wash them with mild soap and warm water, or any retail car soap. Rinse thoroughly to prevent soap residue accumulation. Use caution with high pressure wash nozzles. Keep them at least 18 inches from the edge of the decals. High pressure water may cause the decal to loosen and peel. Test small sections of decals when using any type of cleaning solution.

IMPORTANT

Do not use solvents such as acetone, MEK, toluene, etc. on the decals. Any solvent including alcohol may soften or smear colors. Do not use lacquer thinner or paint on decals. Do not overcoat the decals with clear paint. Do not allow gasoline or other fuels to drip or stay on the decals for any length of time. If this occurs, immediately flush the area with water.

Rubber Roof Care and Maintenance

Proper care and maintenance of your recreational vehicle, including your rubber roof, is important for trouble free performance. Normal maintenance is simple and easy and does not require special materials.

Keep the roof clean. Clean the roof four (4) times annually. For normal cleaning:

1. Use a mild laundry detergent. ZEP - Formula 50 Heavy Duty All Purpose Cleaner and Degreaser is the recommended cleaner. Do not use general purpose cleaners containing petroleum solvents, harsh abrasives, or citric based cleaners.
2. Rinse the complete roof with clean water to remove any loose dirt or debris.
3. Using a medium bristle brush, along with your selected cleaner mixed with water, scrub the entire roof. Rinse thoroughly with clean water to avoid residue build up on the roof or sidewall of the vehicle.

For more difficult stains, you may use cleaning materials mentioned above in a more concentrated mixture. For stubborn stains, using a rag dampened with mineral spirits is recommended. Do not use mineral spirits in a large area or allow it to soak in the roof membrane. Household bleach can also be used (fully concentrated) and allowed to soak in stubborn stain areas, then scrubbed with a medium bristle brush or rag. Rinse thoroughly.

WARNING

Use caution when working on top of your vehicle. The wet roof membrane may be extremely slippery.

INTERIOR CARE

WARNING

Urea-formaldehyde is used in the production of particle board, hardwood plywood, and most paneling. Urea-formaldehyde resin may release formaldehyde vapors into the air, which may cause headaches, and in some people, eye, nose, and throat irritation. Formaldehyde may intensify some allergies or upper respiratory problems like asthma. Proper ventilation should reduce the risk of such problems.

Carpet

A weekly routine of vacuuming the carpet and fabrics throughout the vehicle is recommended. Doing this will prevent an accumulation of dirt that can detract from the material's appearance and shorten its life.

Included in the Owner's Information Package is the carpet manufacturer's Carpet Care Guide. The Carpet Care Guide lists detailed information on cleaning soiled areas and removing stains from the fine carpet installed in the unit.

Fabrics

The fabrics used in this motor home for the bedspread, draperies, headboard, and valances contain fire retardant additives that may be damaged by the use of improper cleaning products. Water-based products are not recommended for cleaning the fabrics in your new unit. Most water-based household cleaning products are not formulated for use on these fabrics and may cause excessive shrinkage or fading. Always test any cleaning product on a hidden area of fabric before using on visible areas. For best results, the fabrics in this unit should be cleaned by a professional carpet and upholstery cleaner.

Spills, spots, or stains should be treated as soon as possible to avoid permanent damage. If a spill occurs, blot the fluid with a dry towel. Do not rub the spill. Rubbing may cause the liquid to "set" in the fabric. When attempting to clean a spot or stain, always start from the outside and work inward to avoid spreading it further. Some stains or soils are extremely difficult or impossible to be removed completely. These should receive immediate professional attention.

WARNING

When cleaning the upholstery and fabric in the unit, do not use lacquer thinner, nail polish remover, laundry soaps, or bleach. Never use carbon tetrachloride or gasoline for cleaning purposes. These items may cause damage to the materials being cleaned and most are highly flammable.

The vinyl material used in creating the interior of this unit should be cleaned with a soft damp cloth and mild detergent. Do not use solvents of any kind. Solvents may damage the surface of the vinyl.

IMPORTANT

The fading of upholstery, carpet, and other interior fabrics is generally caused by excessive sunlight. The drapes, blinds, or shades should be kept closed when the vehicle is parked for an extended period of time to minimize the fading.

Walls and Ceiling

The wall and ceiling coverings should be cleaned periodically to maintain a new appearance. Use a non-abrasive cleaner with a soft cloth on the walls. The ceiling panels should be steam cleaned by a professional carpet cleaner.

Dash

The dash installed in your motor home is made from ABS plastic that has been laminated with a KORAD acrylic film. In order to keep the dash in like-new condition, follow these guidelines:

DO—

- Dust and clean the dash with a soft, damp cloth, or chamois, wiping the surface gently.
- Use pure soap and lukewarm water. Other cleaning agents that can be used are: 409, Mr. Clean, Top Job w/Ammonia, Spic & Span, Johnson's Pledge, Fantastik, Cascade, Janitor in a Drum, Handy Andy, Joy Detergent, Swish Detergent, Calgonite, All Detergent (powder), Isopropanol (45%) rubbing alcohol.
- Dry the surface, after washing and rinsing, by blotting with a damp cloth or chamois.
- Wax the surface sparingly for protection and the highest degree of polish. Apply one of the recommended commercial waxes sparingly in a thin, even film with a soft clean cloth. The recommended waxes are Simonize, Aero Wax, and Glo-Coat.
- Polish waxed surfaces lightly with a clean cotton flannel or jersey. After polishing, wipe gently with a damp cloth to ground any electrostatic charges which may attract dust particles.
- Normal liquid cleaners or soap and water may not remove dirt and grease. Janitor in a Drum and Cascade were found to be the best cleaners to remove ground-in dirty grease.
- Stains such as iodine may be safely removed with 45% isopropanol rubbing alcohol. The higher concentration commercial grades will remove the stain but will dull the film surface. The gloss can be returned with Simonize wax.
- Light scratches can be removed by waxing with Simonize paste wax. Deeper scratches may be removed by lightly buffing with a fine grade of rubbing compound.

DO NOT—

- Use cloths containing grit or abrasive particles or kitchen scouring compounds to clean or dust the dash. Light scratches may be rubbed out with wax.
- Subject the dash to hard, direct blows.
- Use boiling water, strong solvents, or other materials listed below to clean the dash, as they will soften the plastic.
- The following are cleaners and waxes that are not recommended: Wisk, Liquid All, Dynamo, Endust, Lestoil, Pine-Sol, Gain, Halogenated Hydrocarbons, Ketones, Cellusolve Acetate, Aromatic Hydrocarbons (Asmoc G, Solvesso 100, Solvesso 150), Tetrahydrofuran, Butyl Cellosolve, Methanol, Ethanol, Isopropanol (90% and 70%) rubbing alcohol, Gasoline, Brake Fluid, Kerosene, Isopar K, Hexane, Spot Cleaner (Trichlorethane, Trichlorethylene, Perchlorethylene), Abrasives Cleaners, Plasti Shine, Carnu, Turtle Wax, Body Sheene, Johnson's Pride; Dupont No. 7 (Rubbing Compound), Lighter Fluid.

Woodwork

The wood cabinetry should be cared for with furniture polish to sustain the natural beauty and luster of the wood. This will also keep your cabinetry looking new and prevent the wood from drying. The plank flooring should be protected from dents, scratches, and nicks by installing protective pads on the bottom of chairs and tables. Use of area rugs and floor mats by the entrance door is recommended to trap dirt. Sweep or vacuum the floor often and wipe up spills as soon as possible. Clean with a hardwood floor cleaner. Do not use wax, dish washing detergent, abrasive chemicals or oil cleaners on the wood floor. Silicone or solvent based polishes (for example, waxes, oil soap, vinegar, ammonia, Pledge, Fantastic, Formula 409, etc.) will make the floor harder to clean because of residual deposits. Wipe up spills and avoid allowing moisture to accumulate on the woodwork.

Counter Tops

To care properly for the countertop in your new unit, always use a heat pad or trivet to protect the surface from hot objects that may mar or damage the surface. Wipe the counter top with a damp cloth to remove water spots. For stains, wipe with soapy water or ammonia based cleaners.

Accessories

The brass light fixtures, bath accessories, and faucets can be cleaned by wiping with a soft damp cloth. Washing with warm water will remove dry water spots. Do not use cleaners that contain harsh or abrasive chemicals. Alcohol or similar solvents should never be used.

Detectors

The CO and LP detectors are self-contained and DO NOT require any maintenance other than normal cleaning and dusting. The smoke detector installed in this coach is 9 volt battery operated. The battery needs to be tested periodically and replaced when necessary. When cleaning the case on any of the detectors use a damp cloth or paper towel. Do not spray cleaners or wax directly into the case as it may cause false alarms.

Windows

The glass in the windows may develop water spots, especially if water containing salts or other matter is not properly removed. The spotting effect is magnified when the glass has a reflective finish. Using a squeegee immediately after washing will help reduce water spotting.

Condensation

The following information is to make the retail owner of this unit aware of the potential problem with condensation in a recreational vehicle. Damage may occur to your unit if excessive condensation exists.

ROUTINE MAINTENANCE

Below is a brief list of basic routine maintenance items that should be checked as follows:

Every Trip

- Check all of the engine fluids
- Check the tire pressure of all tires
- Tighten all lug nuts on all of the wheels
- Check the running lights

Every Month

- Clean range hood exhaust fan filter and blades
- Check gas lines for leaks with soap solution or leak detector
- Test smoke alarm, carbon monoxide detector, and LP gas detector
- Check operation of windows, latches, and hinges
- Clean the roof ducted air conditioner filter

Every 6,000 Miles or 3 Months

- Check all fluid levels
- Change the oil and the oil filter
- Check the air intake system
- Inspect the slide out room for alignment, adjust if necessary
- Clean all door and window seals
- Inspect and repair broken seals around the tub and shower area
- Lubricate the exterior door hinge and latch with a graphite (silicone) lubricant
- Check, clean, and tighten battery cables
- Check steering for noise or play
- Check radiator and hoses for leaks
- Check belts for tension and for cracks

Every 12,000 Miles or 6 Months

- Lubricate exterior doors and locks with silicone
- Inspect the slide out room for alignment, adjust if necessary
- Rotate tires and check alignment
- Check gas appliances for proper operation
- Clean window and door seals with a mild soap and spray with silicone lubricant
- Lubricate the moveable parts on the entrance step
- Check the wheels and nuts for cracks and the tightness of the lug nuts
- Check the antifreeze level
- Have the LP system checked by a qualified technician

Annually

- Inspect roof seams and joints, reseal when necessary or consult your dealer
- Sanitize the fresh water system
- Check the front end alignment
- Have the axle bearings re-packed

WINTERIZING

To store your unit for the winter months, it is necessary to winterize the water system to help prevent freezing. To do this, follow these instructions:

1. The water heater must remain off during this process. Shut off the water pump and make sure the water supply valves are closed.
2. To drain the fresh water tank, open the drain valves.
3. Open the low point drain valves. There is one drain valve for each water line, one cold and one hot. This is done to drain all of the water out of the system.

4. After the water heater has cooled off, remove the drain plug to drain the water from the water heater. In the exterior compartment beside the water heater there are two water heater shut-off valves and a by-pass valve. The shut-off valves must be closed and the by-pass valve must be open, prior to winterizing, to prevent the antifreeze solution from entering the water heater.

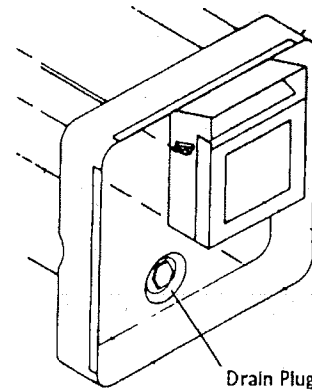

5. Close the low point drains to prevent the antifreeze from draining through the lines onto the ground.
6. Remove the water filter. See Chapter 11 for more information.
7. Close the water supply valve that flows from the pump to the tank.
8. Use only non-toxic antifreeze that has been approved for use in drinking/potable water systems. Place the in-take hose into the antifreeze supply. Open the antifreeze valve to allow the solution to flow freely. Once the water pump is turned on, proceed to the kitchen faucet, bath faucet, inside and outside shower, turning on the hot and cold water and flushing the stool until the antifreeze solution flows freely. If the unit is equipped with a washer, be certain to purge the air from it also. This forces the antifreeze through all of the water lines and faucets. It also allows the antifreeze solution to enter the drain lines and prevent the p-traps from freezing. Check the antifreeze solution from time to time to make sure there is an adequate supply.
9. Close the antifreeze valve when the winterizing process is complete. Store the in-take hose and turn the water pump off.
10. Open the water supply valve that flows from the pump to the tank to help prevent freezing on that water line.

CHAPTER 15

CHARTS & DIAGRAMS

Table of Contents

Model Numbers	15 - 1
Maintenance Record	15 - 3
Fuel & Mileage Log	15 - 5
12 Volt Distribution Panel	15 - 7
30 Amp Distribution Panel	15 - 9
50 Amp Distribution Panel	15 - 11
Wiring Color Scheme	15 - 13
Inverter Wiring Diagram	15 - 17
Typical 12 Volt Wiring Diagram	15 - 19
Typical Fresh Water Diagram	15 - 21
Typical Drain Line Diagram	15 - 23
Water Works Compartment Diagram	15 - 25
Slide Out Mechanism	15 - 27
Brief Parts Listing	15 - 29



**IMPORTANT INFORMATION
FOR YOUR
NEWMAR MOTORHOME**

Coach: Year _____ Model _____ Serial _____
 Chassis: Make _____ VIN _____

Appliance	Brand	Model	Serial
Refrigerator	_____	_____	_____
Freezer	_____	_____	_____
Water Heater	_____	_____	_____
Range	_____	_____	_____
Converter	_____	_____	_____
Washer	_____	_____	_____
Dryer	_____	_____	_____
Microwave	_____	_____	_____
Icemaker	_____	_____	_____
Television, front	_____	_____	_____
Television, rear	_____	_____	_____
Radio	_____	_____	_____
CD Player	_____	_____	_____
CB Radio	_____	_____	_____
Generator	_____	_____	_____
Air Conditioner, front	_____	_____	_____
Air Conditioner, rear	_____	_____	_____
Video Cassette Recorder (VCR)	_____	_____	_____
Rear View Monitor	_____	_____	_____
Furnace, front	_____	_____	_____
Furnace, rear	_____	_____	_____

HOT FEED LINES FROM BATTERIES AND
CONVERTER, WITH OVERCURRENT PROTECTION

GROUND TO CHASSIS, CONVERTER
AND BATTERIES MINIMUM SIZE #8

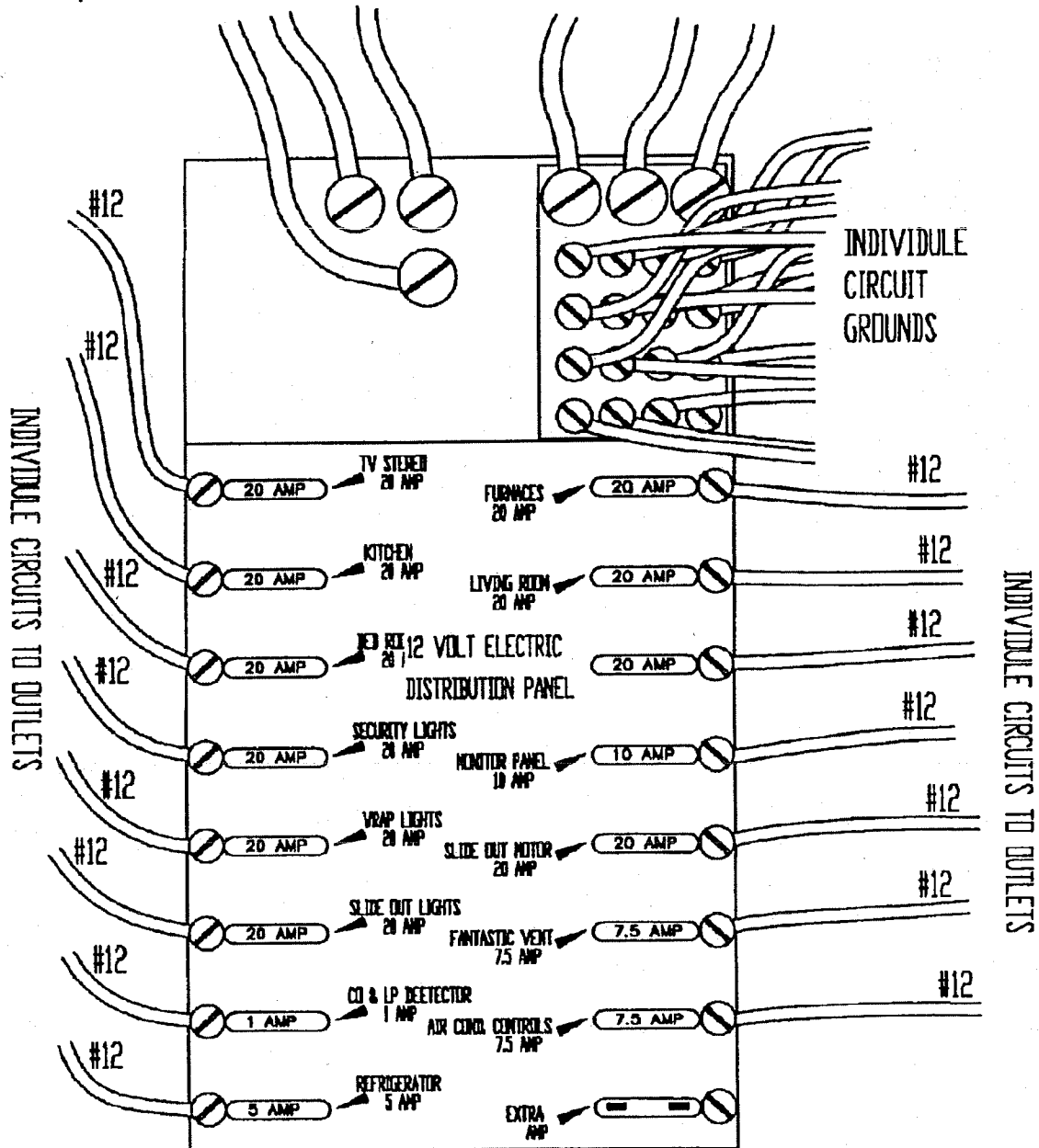

WIRE OVER CURRENT PROTECTION IS PER THIS CHART

WIRE SIZE	AMPACITY	WIRE SIZE	AMPACITY
# 6	55	# 8	40
#10	30	#12	20
#14	15	#16	8
#18	6		

12 VOLT ELECTRIC
DISTRIBUTION PANEL

load protection

30 AMP MAIN	
AIR CONDITIONER	# 1
	20 AMP
MICROWAVE	# 2
	15 AMP
CONVERTER & 8 RECEPES	# 3
	15 AMP
REFRIGERATOR & 8 RECEPES	# 4
	15 AMP
WATER HEATER	# 5
	15 AMP

30 AMP 110 SERVICE

30 Amp lead in cord & wire = 10/2 w/ground
 20 Amp circuit wire = 12/2 w/ground
 15 Amp circuit wire = 14/2 w/ground

Maximum of 10 outlets (lights and recepts) on any 15 amp circuit with no other appliance on that line. Circuits 3 and 4 may have recepts as noted at left. NOTE: A duplex recept is counted as 1 recept.

Not all units will get all of these items

load		protection		50 AMP MAIN	
1st	# 1	# 1	# 13		
AIR COND.	20 AMP	20 AMP	15 AMP		
MICROWAVE	# 2	# 2	# 14	MAY HAVE 10 RECEPIS	
	15 AMP	15 AMP	15 AMP		
CONVERTER & 5 RECEPIS	# 3	# 3	# 15	MAY HAVE 10 RECEPIS	
	15 AMP	15 AMP	15 AMP		
REFRIGERATOR	# 4	# 4	# 16	DISHWASHER & 2 RECEPIS	
FOOD CENTER & 5 RECEPIS	15 AMP	15 AMP	15 AMP		
WATER HEATER	# 5	# 5			
	15 AMP	15 AMP			
DRYER	# 6	# 6			
	15 AMP	15 AMP			
WASHER	# 8	# 8			
	15 AMP	15 AMP			
2nd AIR COND.	# 8	# 8			
	20 AMP	20 AMP			

This is a 50 Amp 220 service

50 Amp lead in cord to box = 6/3 w/ground
 20 Amp circuit wire = 12/2 w/ground
 15 Amp circuit wire = 14/2 w/ground

Maximum of 10 outlets (lights and receipts) on any 15 amp circuit with no other appliance on that line. Circuits 3, 4, and 16 may have receipts as noted at left. NOTE: A duplex recept is counted as 1 recept.

This is a fully loaded system for which there has been a calculation done. Not all units will get all of these items.

Wiring Color Scheme

8 gauge

Grounds	White
Battery	Red
Converter	Black
Solar Prep	Green

10 gauge

Grounds	White
Living Room Entry Lights (hot feed)	Red
Bedroom Lights (hot feed)	Orange
Kitchen Lights (hot feed)	Green
Bathroom Lights (hot feed)	Brown
Power Rear Awning & Freezer	Purple w/Yellow
Power Step (hot feed)	Green w/Black
Power Jacks	Yellow
Electric Brakes (tri-axle)	Blue
100 Watt Inverter	Red w/White

16 gauge

Larson Monitor Panel Tank Harness	Fresh Water Tank	White* Grey w/Black (replaces Red tank lead) * Black w/Yellow (replaces Blue tank lead) *
	Grey Water Tank	White* Green w/White (replaces Red tank lead) * Blue w/Black (replaces Blue tank lead) *
	Black Water Tank	White* Red w/White (replaces Red tank lead) * Blue w/White (replaces Blue tank lead) *

* - multiple applications for this color

12 gauge

Grounds	White
Living Room & Entryway Lights (hot to switch)	Red
Living Room & Entryway Lights (switched)	Red w/White
Bedroom Lights (hot to switch)	Orange
Bedroom Lights (switched)	Orange w/White
Bathroom Lights (hot to switch)	Brown
Bathroom Lights (switched)	Brown w/White
Kitchen Lights (hot to switch)	Green
Kitchen Lights (switched)	Green w/White
Wrap & Storage Compartment Lights	Black
TV and Stereo	Pink
Furnaces	Green w/Black
3 Way Switches (commons)	Red w/Black
Fantastic Vent and Water Heater	Brown w/Black
Monitor Panel	Yellow
Security Lights (hot to switch)	Purple
Security Lights (switched)	Purple w/White
Slide Out Module (hot feed)	Green/Yellow
Slide Out Motor & Voice Module	Black w/Yellow & Red w/Yellow
Slide out Lights	Grey
Water Pump	Yellow w/Black
Power Step Switch	Black w/White
Electric Brakes (tandem axle)	Blue

16 gauge

Grounds	White
Back-up Lights	Yellow
Ignition to Power Step	Pink
Clearance & Running Lights	Green
Right Turn Lights	Brown
Left Turn Lights	Red
Ignition to Slide Out Motor	Pink w/Green
Class A Blower Fan (in holding tank area)	Orange
Slide Out Switch	Purple
Courtesy Lights (hot to switch)	Grey
Courtesy Lights (switched)	Grey w/White
Detectors, CO & LP	Red w/Black
Rear Center Brake Light	Blue
LP Fuel Gauge	Red w/Yellow
Air Conditioner Controls	Pink w/Black
Monoplex Water Pump Switch	Yellow w/Black
Refrigerator Controls	Purple w/White
Vent Thermostats	Black
Water Heater DSI Switch Harness	Red w/White*
	Green w/White*
	Blue w/White*
	Red w/White*
	Green w/White*
Diesel Generator	Blue w/White*
Gas Generator	Grey w/Black*
Start/Stop Switch	Black w/Yellow*
Harness	White*

* - multiple applications for this color

TYPICAL WIRING DIAGRAM FOR INVERTERS

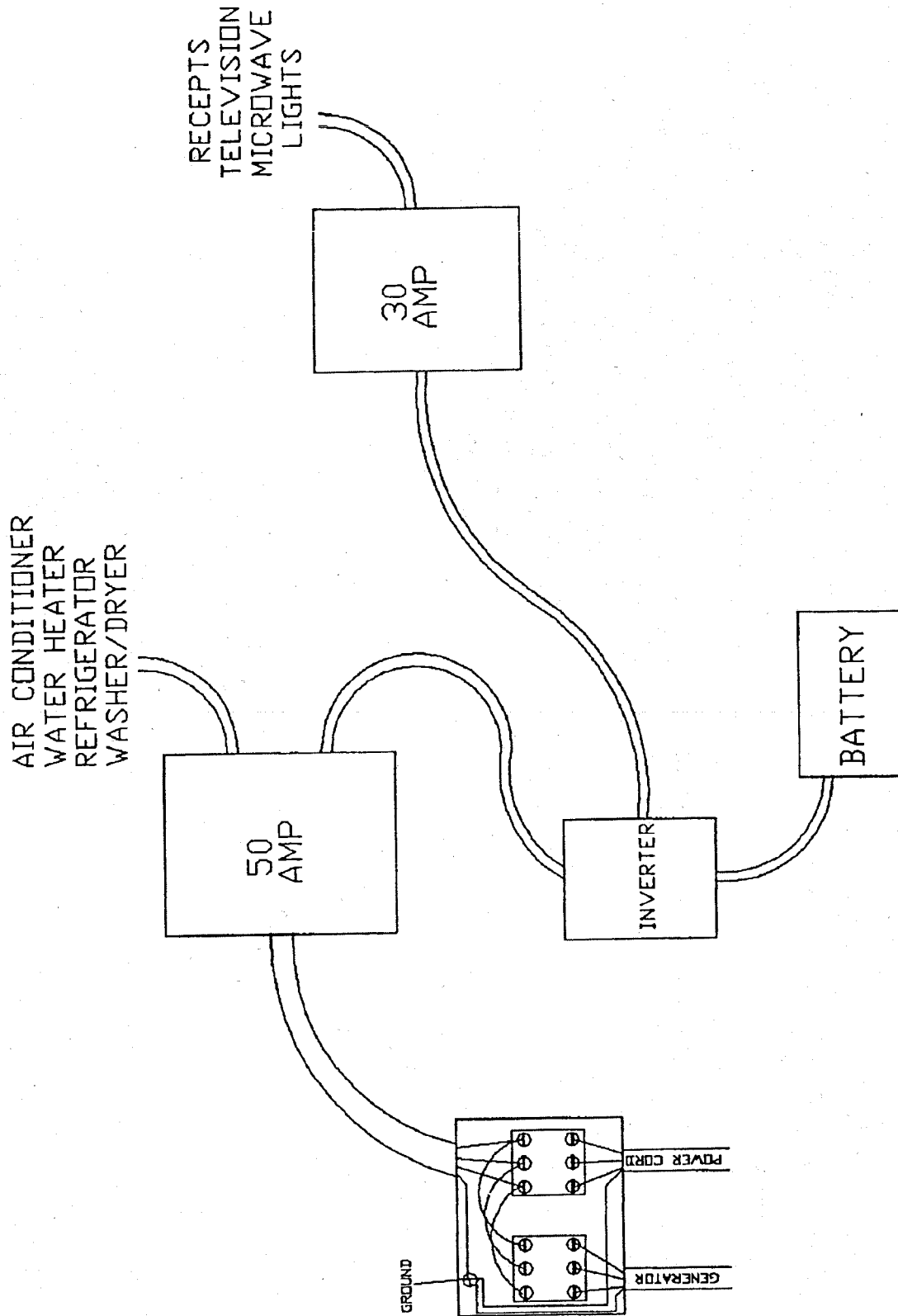

TYPICAL 12 VOLT WIRING DIAGRAM – MOTOR HOME

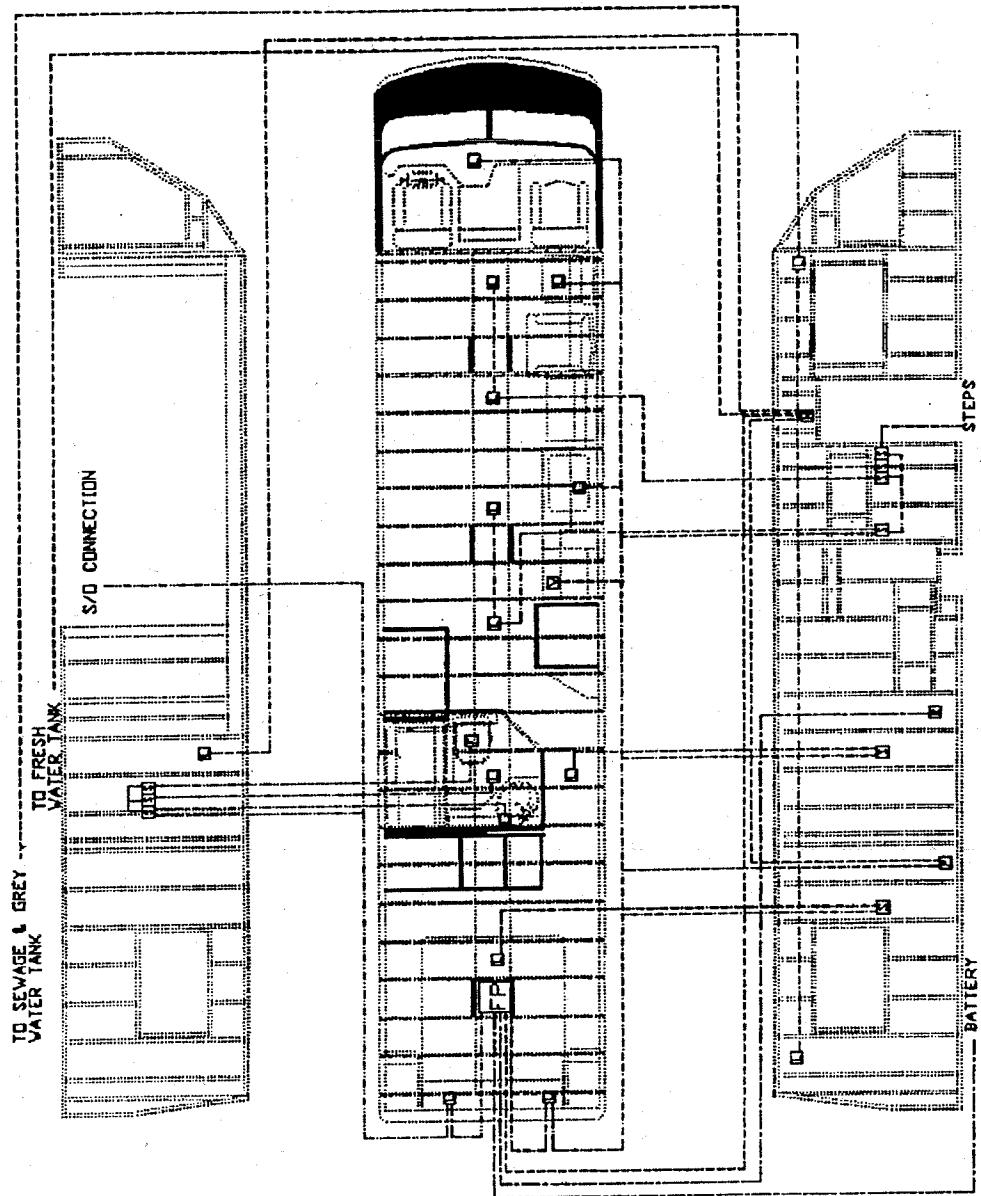

- - - - - MONITOR LINE
 _____ DOOR SIDE
 - - - - - OFF DOOR SIDE
 INDIVIDUAL LINE

L - LIGHT
 S - SWITCH
 T - TV JACK
 V - RANGE VENT FAN
 R - REFRIGERATOR
 W - WHEATER (REIGNITOR OPT.)
 M - MONITOR PANEL
 F - BATH VENT FAN
 FP - FUSE PANEL
 P - WATER PUMP

NOTE:
 ALL WIRES SHOWN DO NOT NECESSARILY
 RUN THROUGH A SPECIFIC STUD.
 THIS PRINT SHOWS GENERAL LOCATIONS
 OF WIRES ONLY.

TYPICAL FRESH WATER DIAGRAM

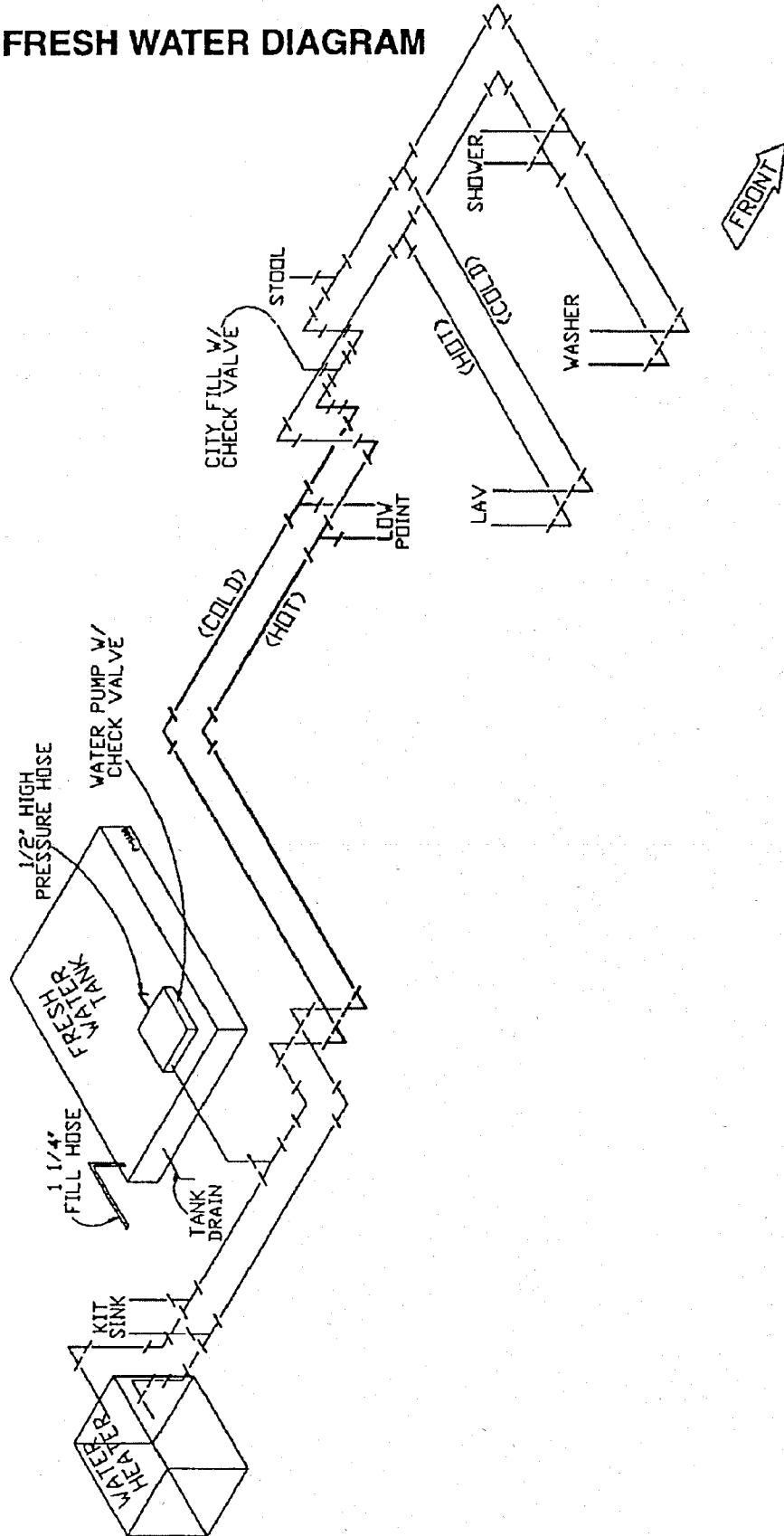

TYPICAL DRAIN LINE DIAGRAM

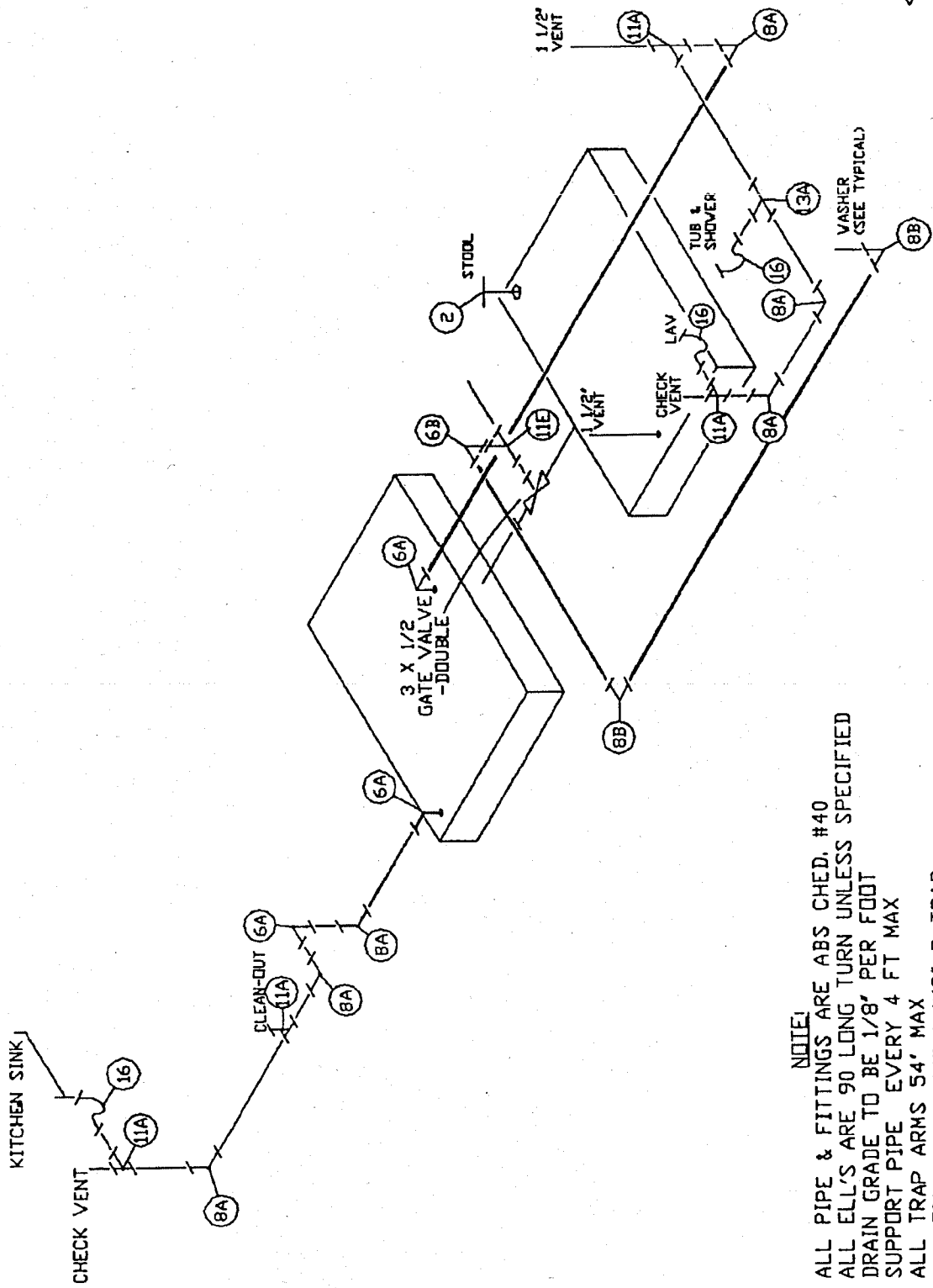

NOTE:
 ALL PIPE & FITTINGS ARE ABS CHED. #40
 ALL ELL'S ARE 90 LONG TURN UNLESS SPECIFIED
 DRAIN GRADE TO BE 1/8" PER FOOT
 SUPPORT PIPE EVERY 4 FT MAX
 ALL TRAP ARMS 54" MAX
 ALL FIXTURES HAVE 1 1/2" P-TRAP
 ALL TANK HOOK-UPS ASE A DOUBLE LTTY UNLESS SPECIFIED OTHERWISE
 BELOW FLOOR PLUMBING

TYPICAL WATER WORKS COMPARTMENT

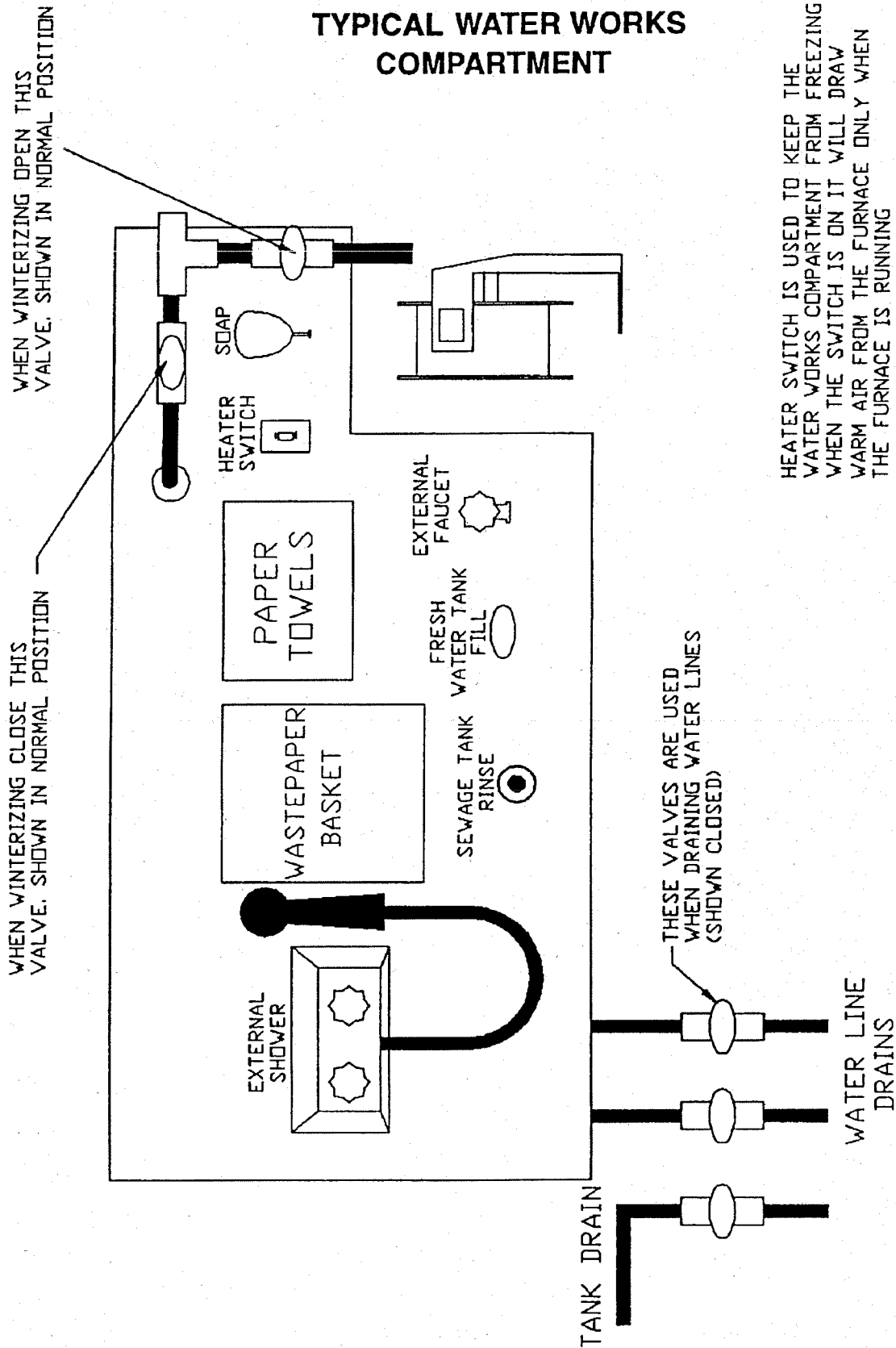

SLIDE-OUT MECHANISM

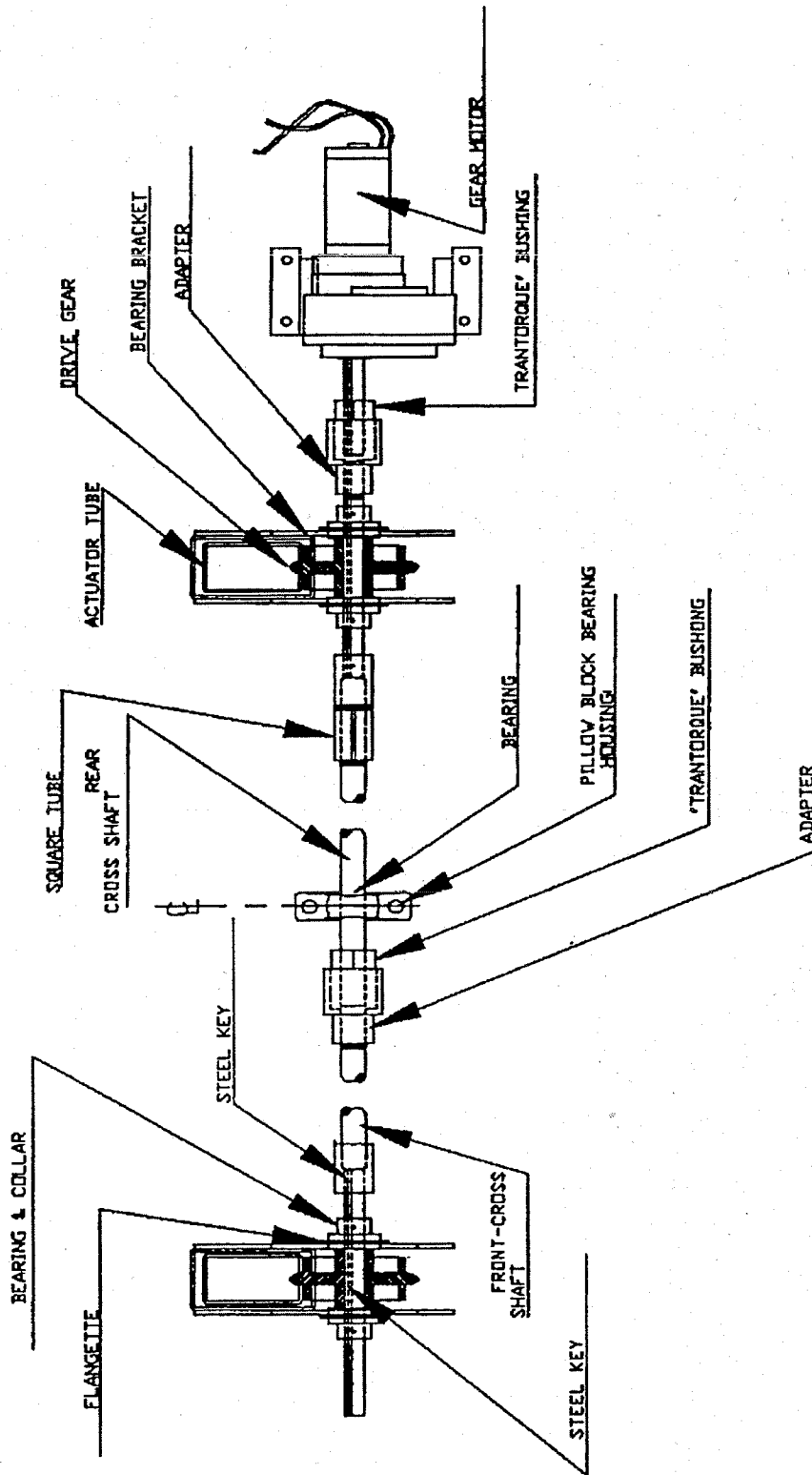

Mountain Aire Diesel Pusher	
Description	Item #
Air Horn	NK 28553
Antenna, CB	QD 11569
Antenna, Cellular Phone	QD 29642
Antenna, Radio	QD 15654
Antenna, TV	QD 18380
A/C	QA 20097
Bumper, Front, Center	GG 29170
Bumper, Rear	GG 22203
Door, Entrance	ID 27154
Door, Furnace	QC 21868
Door, Refer Vent	QF 11526
Door, Water Heater	QG 24915
Faucet, Bath	CM 22540
Faucet, Kitchen, Sgl Hdl	CM 29207
Faucet, Shower	CM 22541
Grab Handle, Acrylic, Door	NA 16229
Grab Handle, Chrome, Door	NA 12316
Grab Handle, Chrome, Door	MC 11665
Grill	GG 29355
Hood	GG 29574
Ladder	NA 17187
Light, Clearance, Amber	EH 18684
Light, Clearance, Red	EH 20619
Light, Clearance, Side(Turn)	EH 21391
Light, Docking	EH 13851
Light, Fog	EH 29330
Light, Head, Left Hand	EH 22032

Mountain Aire Diesel Pusher	
Description	Item #
Light, Head, Right Hand	EH 22031
Light, Scare	EH 10674
Light, Spot	EH 12300
Light, Tail, Back Up	EH 17075
Light, Tail, Center	EH 17074
Light, Tail, Wrap Around	EH 17073
Mirror, Rear View	NB 27356
Recept, 12 Volt, Brown	EB 22281
Recept, 12 Volt, White	EB 10641
Recept, 120 Volt	EB 10551
Recept, GFCI	EB 10553
Register, Ceiling	QC 22580
Register, Floor	QC 12292
Roof Rack	NA 11820
Skylight	IS 14607
Step, Bumper, Fold-A-Way	NK 16169
Step, Kwikkee	ID 27342
Switch, 12 Volt, Double	EB 24810
Switch, 12 Volt, Single	EB 24809
Switch, 12 Volt, Triple	EB 24811
Switch, 120 Volt	EB 10543
T-Stat, Dometic	QA 27782
T-Stat, FanTastic Vent	IS 01513
Windshield Gasket	PE 27261
Windshield, Left Hand	IO 26315
Windshield, Right Hand	IO 26316

