

NEW MAR



OWNER'S GUIDE

2000 Kountry Star

CLASS A MOTORHOME

NEWMAR CORPORATION OWNER'S GUIDE

Table of Contents

Chapter 1	General Information
Chapter 2	Driving & Safety Precautions
Chapter 3	Air Conditioning & Heating
Chapter 4	Appliances & Accessories
Chapter 5	Cabinets & Furniture
Chapter 6	Structure Features
Chapter 7	Electrical Features
Chapter 8	Slide Out Features
Chapter 9	Exterior Features
Chapter 10	Interior Features
Chapter 11	Plumbing & Bath Features
Chapter 12	Construction Features
Chapter 13	Windows, Awnings, Vents & Doors
Chapter 14	Routine Maintenance
Chapter 15	Charts & Diagrams

CHAPTER 1

GENERAL INFORMATION

Table of Contents

Delivery	1 - 1
Limited Warranty	1 - 2
Major Equipment Manufacturers	1 - 2
Warranty Service	1 - 3
Owner's Information Package	1 - 3
Customer Relations	1 - 3
Reporting Safety Defects	1 - 3
Specification Label	1 - 4
Recommended Service Centers	1 - 5

Welcome to the exciting world of RV traveling and the growing family of recreational vehicle owners.

Congratulations on your purchase of a Newmar product. We sincerely thank you for choosing Newmar as your recreational vehicle. We trust this guide will help you to better understand and enjoy your new RV. We hope that you will enjoy many miles of traveling. Your new vehicle was built with care using today's technology and old world craftsmanship. We, at Newmar, strive to build vehicles that are safe, dependable, and comfortable to provide years of carefree, pleasant traveling.

This Owner's Guide, along with the Video Guide, should be kept in your vehicle for quick reference. Take time to get acquainted with your unit and how it operates. Carefully read both the instructions in this guide and the booklets supplied by the component manufacturers for important operation, safety, and maintenance information. Your dealer should be consulted should you have any questions. If your dealer is unable to answer the questions to your satisfaction, he will refer you to our staff for help. Our customers are extremely important to us, and we will make every effort necessary to ensure your satisfaction.

Again, thank you and welcome to our Newmar family.

Newmar Corporation

This guide, along with the Video Owner's Guide, has been provided by Newmar Corporation solely for the purpose of providing instructions about the operation and maintenance of this vehicle and its components. Nothing in this manual creates any warranty, either express or implied. The only warranty offered by Newmar Corporation is set forth in the written limited warranty that applies to this vehicle.

Instructions are included in this manual for operating some of the components that are standard on this vehicle. Instructions are also given for components that are options and may not appear on all vehicles. For more detailed information on components refer to the individual manufacturer's operating instructions contained in the Owner's Information Package.

The limited warranties issued by component manufacturers require periodic service and maintenance, and the owner's failure to provide this service and/or maintenance will result in the loss of warranty coverage. The owner should review the Newmar Corporation limited warranty and other manufacturers' limited warranties of all components applicable to this vehicle. To activate the warranties on the components within your Newmar recreational vehicle, be sure to file the appropriate registration card with the component manufacturer as described with the individual instruction booklet.

Newmar Corporation has compiled the most current information available at the time of publication. If the components in your unit vary significantly from what is described within this manual, then consult the instructions provided by the component manufacturer found in the Owner's Package.

Throughout this guide, reference is made to the following terms: Warning, Caution, and Important. These terms indicate important information that must be understood and followed. The definitions of these terms are:

WARNING
Emphasizes an area in which personal injury or even death could result from failure to follow instructions properly. Mechanical damage may also occur.

CAUTION
Failure to observe a caution can cause damage to the equipment or unit. Personal injury is unlikely.

IMPORTANT
Provides additional information to make a step easier or clearer.

DELIVERY

Throughout the manufacturing process your vehicle has been inspected by our qualified technicians. However, our final inspection at the factory is not to be the last one. The pre-delivery inspection and systems check your dealer performs are the final inspections done to the unit prior to you receiving your new coach. Your dealer is also available to assist you in understanding the limited warranties and completing any necessary forms to activate the warranties for the various appliances and accessories installed in your unit.

Dealer Responsibilities

1. A pre-delivery inspection and systems check. Thoroughly inspecting the vehicle and the operation of the factory installed components.
2. A customer walk-through. This is done to familiarize the customer with the vehicle, its systems and components, and their operation.
3. Delivery of the Owner's Information Package. This package contains the warranty cards and registrations for the vehicle and factory installed components that carry a separate warranty. The detailed operating and maintenance instructions on these components are also included in this package.
4. Assisting the customer in completing the component registration forms, at the customer's request. To avoid loss of warranty coverage, the dealer should review the limited warranty provisions with the customer stressing the importance of filing warranty cards and registrations to the component's manufacturers within the prescribed time limit.
5. Providing the customer with information regarding warranty and non-warranty work on the vehicle and its separately warranted components whether the customer is in or out of the area.

Customer Responsibilities

The customer is responsible for regular and proper maintenance of the vehicle. Properly maintaining your vehicle will prevent conditions arising from neglect that are not covered by your Newmar limited warranty. The maintenance guidelines in this manual and any other applicable manual should be followed. It is your responsibility and obligation to return the vehicle to an authorized dealer for repairs and service.

To assist you in avoiding problems with your vehicle, we recommend you do the following:

- a. Read the warranty. Go over it thoroughly with your dealer.
- b. Inspect the vehicle. Do not accept delivery until you have gone through the unit with the dealer. Newmar has provided a check list to be used during retail delivery. Check each item on the list and make sure the dealer does the same. Do not sign this checklist until you have done this.
NOTE: The sales literature versus actual specifics to the vehicle's measurements, weights, or quantities may vary.
- c. Ask questions about anything that you do not understand concerning your recreational vehicle.
- d. When taking delivery, set an appointment for adjustments. This appointment should be approximately two (2) weeks after you accept delivery.
- e. Responsible Use. Your vehicle is designed to be used for recreational or temporary living purposes. It is not designed to be used as a full-time residence or for commercial use. Commercial use means using as a business asset such as a mobile office or using the vehicle for lease/rental purposes.

RECREATIONAL VEHICLE LIMITED WARRANTY

The Newmar Corporation Limited Warranty was provided to you by your selling dealer prior to purchase. Please refer to this document when inquiring about the Newmar Warranty. To receive an additional copy, please write to: Newmar Corporation, Warranty Department, P.O. Box 30, Nappanee, IN 46550-0030.

Major Equipment Manufacturers

A & E Awnings800-544-4881
AntennaTek303-772-9591
Atwood (LP Detector & Water Heater)815-877-5700
Clarion Back Up Systems800-366-4567
Diesel Equipment (Wiper System)910-373-8331
Dometic, Duo Therm800-544-4881
Evans Dash Air Conditioning800-354-7088
Exide Batteries800-537-9434
Fantastic Vents800-521-0298
Flexsteel319-556-7730
Ford Motor Company800-444-3311
Freightliner Chassis864-488-8388
Gekotek Electronics (Monitor Panel)714-738-3551
Generac Generators800-747-1530
Goodyear Tires800-227-1999
Heart Interface800-446-6180
HWH Leveling Jacks800-494-3213
Kwikkee Products (Step)800-736-9961
Magnadyne219-262-4479
Magnavox Appliances800-851-8885
Michelin Tires800-847-8475
Newmar Corporation800-731-8300
Norcold Refrigeration800-543-1219
Onan Generators800-888-6626
Panasonic Microwaves888-433-6486
Pioneer800-777-4856
Power Tech Generators800-760-0027
Sealand Toilets800-321-9889
Sears Washer & Dryer800-359-2000
Sharp800-334-8251
Sony800-222-7669
Spartan Motors800-543-4277
Splendide Washer/Dryer504-229-4922
Suburban Furnace800-659-2138
Thetford Toilet800-521-3032
Michigan Residents313-769-6000
Todd Engineering800-439-8633
U-Line Ice Maker800-779-2547
Ventline (Range Hood)219-848-4491
Wedgewood Range (Atwood)815-877-5700
Wilson Art Flooring800-433-3222
Winegard Antenna Systems800-288-8094

Warranty Service

Warranty service required needs to be completed during the term of the warranty. Service work performed after the expiration of the Newmar three (3) year, 36,000 mile warranty **WILL NOT** be covered by the warranty. Exceptions may be made on an individual basis to this deadline due to unavailability of parts or service appointment time where work is to be performed. Don't rely on the possibility of an exception. Get the work scheduled and completed before your warranty expires.

Owner's Information Package

Included in this package are valuable documents about your vehicle and its components and systems. The Newmar Owner's Guide does not cover every possible detail of equipment, standard and/or option, installed on or in your vehicle. Consulting the booklets and instruction manuals in this package will help you safely operate, maintain, and troubleshoot these items.

Read all of the information and understand the safety and operating instructions included in the Owner's Information Package. To assure full warranty coverage, it is essential that all maintenance instructions are followed.

CUSTOMER RELATIONS

If you wish to schedule maintenance, service or to order parts, you should notify your local Authorized Newmar Service Center to set up an appointment. If you are unsure of the location of your closest Authorized Newmar Service Center, see the listing in the manual.

You may also write to:
Newmar Corporation
Warranty Department
P.O. Box 30
Nappanee, IN 46550-0030

REPORTING SAFETY DEFECTS

If you believe that your vehicle has a defect which could cause a crash or could cause injury or death, you should immediately inform the National Highway Traffic Safety Administration (NHTSA) in addition to notifying Newmar Corporation.

If NHTSA receives similar complaints, it may open an investigation, and if it finds that a safety defect exists in a group of vehicles, it may order a recall and remedy campaign. However, NHTSA cannot become involved in individual problems between you, your dealer, or Newmar.

To contact NHTSA, you may either call the Auto Safety Hotline toll free at 1-800-424-9393 (or 366-0123 in Washington, D.C. area) or write to: NHTSA, U.S. Department of transportation, Washington, DC 20590. You can also obtain other information about motor vehicle safety from the hotline.

SPECIFICATION LABEL

There are two main numbers used to identify the vehicle. The Vehicle Identification Number (VIN) is the legal identification of the completed vehicle. The VIN is the number used by the state for vehicle registration. The Newmar Serial Number (1) is a five digit number that is needed whenever making an appointment for service or ordering parts through your Newmar Dealer or Service Center. This number can be found on the placard in the kitchen overhead and on the Customer Care Card received from Newmar. Below is a sample of the placard located in the kitchen.

1. The Newmar Serial Number
2. Last five digits Vehicle Identification Number (VIN)
3. Model Number of the Unit
4. Model Year of the Unit
5. Manufacturer, Model Number, and Serial Number of factory installed appliances

SPECIFICATION LABEL					
SERIAL #	XXXXXXXX	VIN #	XXXXXXXXXXXXXXXXXXXX	MODEL #	XXXXXXXXXX
DECOR #	XXXXXX	WOODCOLOR	XXXXXXXX	MODEL YEAR	XXXX
HEIGHT	XXXXXXXX	DRY WEIGHT	XXXXXX	LENGTH	XXXXXXXX
APPLIANCE INFORMATION					
	MODEL #	SERIAL #		MODEL #	SERIAL #
FRONT A/C	620315 421	XXXXXXXX	REAR A/C	620315.421	XXXXXXXX
FRONT TV	XR1901	XXXXXXXX	REAR TV		
FRONT FURN.	SF42	XXXXXXXX	DASH A/C		XXXXXX
WATER HEATER	SW100E	XXXXXXXX	RANGE	C378P	XXXXXXXX
GENERATOR 15MHFA2610DN		XXXXXXXX	AUX.HEATER		
FRONT RADIO	EXGD-21	XXXXXX	REAR RADIO		
WASHER			DRYER		
CB RADIO			VCR		
CONVERTER	TODD	XXXXXXXX	MICROWAVE	R1850	XXXXXX
REFRIGERATOR	RM0602	XXXXXXXX	BLENDER		
MONITOR	CJ750E	XXXX	FREEZER		
ICE MAKER			DISHWASHER		
SAFE			CD PLAYER		

Notes

RECOMMENDED SERVICE CENTERS

ALABAMA

MADISON RV CENTER

1707 JORDAN LANE N.W.
HUNTSVILLE AL 35816
(256) 837-3881 Fax (256) 830-4451

MILLICAN RV AMERICA

36115 US HWY. 280
SYLACAUGA AL 35150
(256) 249-3773 Fax (256) 249-3958

REED CAMPER SALES

2405 JORDAN LANE
HUNTSVILLE AL 35816
(256) 830-5024 Fax (256) 830-4682

ARIZONA

AMERICAN PRIDE RV CENTER

2145 E. MAIN ST.
MESA AZ 85213-9100
(480) 644-1500 Fax (480) 644-0293

LA MESA RV CENTER

2260 E. MAIN ST.
MESA AZ 85203
(480) 834-4900 Fax (480) 834-4800

LA MESA RV CENTER

3255 E. IRVINGTON RD.
TUSCON AZ 85714
(520) 745-4900 Fax (520) 294-7635

LA MESA RV CENTER

6651 GILA RIDGE ROAD
YUMA AZ 85364
(520) 344-4900 Fax (520) 341-9415

ARKANSAS

OUTDOOR LIVING CENTER

HWY. 7 SOUTH
P.O. BOX 1081
RUSSELLVILLE AR 72801
(501) 968-7706 Fax (501) 968-4360

CALIFORNIA

ALPINE RECREATION SLS & SVC

19380 MONTEREY ROAD
MORGAN HILL CA 95037
(408) 779-4511 Fax (408) 779-0754

DAVE ALTMANS RV

1201 BALDWIN PARK BLVD.
BALDWIN PARK CA 9170
(626) 960-1884 Fax (626) 962-6906

DAVE ALTMANS RV

22020 RECREATION ROAD
CARSON CA 90745
(310) 518-6182 Fax (310) 513-0500

DAVE ALTMANS RV

1313 RV CENTER DRIVE
COLTON CA 92324
(909) 422-0311 Fax (909) 422-0450

LA MESA RV CENTER

5200 CHILES ROAD
DAVIS CA 95616
(530) 750-5070 Fax (530) 759-8139

LA MESA RV CENTER

7430 COPLEY PARK PLACE
SAN DIEGO CA 92111
(858) 874-8000 Fax (858) 874-8042

MANTECA TRAILER & CAMPER

1990 E. YOSEMITE AVE.
MANTECA CA 95336
(209) 239-1267 Fax (209) 239-4348
COLORADO

ALPINE TRAVEL TRAILERS

2487 HIGHWAY 6 & 50
GRAND JUNCTION CO 81505
(970) 242-5898 Fax (970) 242-5989

J D L TRAILER SALES

2734 LAKE AVENUE
PUEBLO CO 81004
(719) 564-8056 Fax (719) 564-0306

MOUNTAIN STATES RV

14300 E. COLFAX AVENUE
AURORA CO 80011
(303) 360-0252 Fax (303) 363-9103

CONNECTICUT

DAVE'S RV CENTER

2 INDUSTRIAL PLAZA ROAD
DANBURY CT 06810
(203) 730-1744 Fax (203) 730-1741

DELAWARE

SLICERS CAMPING TRAILERS

773 S. DUPONT HWY.
NEW CASTLE DE 19720
(302) 836-4110 Fax (302) 836-4781

FLORIDA

DICK GORE'S RV WORLD

14590 DUVAL PLACE WEST
JACKSONVILLE FL 32218
(904) 741-5100 Fax (904) 741-4905

FREIGHTLINER OF SO. FLORIDA

1699 N. US 1
FORT PIERCE, FL 34950
(561) 466-9424 Fax (561) 466-5102

INDEPENDENCE RV

12705 W. COLONIAL DRIVE
WINTER GARDEN FL 34787
(407) 877-7878 Fax (407) 877-3806

LAND YACHTS

1414 COMMERCE LANE
P.O. BOX 1840
JUPITER FL 33468
(561) 745-0242 Fax (561) 745-1725

LEISURE TYME RV

1490 HWY. 98 WEST
MARY ESTHER FL 32569
(850) 581-0880 Fax (850) 581-2300

LEISURE TYME RV

6428 PENSACOLA BLVD.
PENSACOLA FL 32505
(850) 476-6848 Fax (850) 474-6392

NORTH TRAIL RV CENTER

5270 ORANGE RIVER BLVD.
FORT MYERS FL 33905
(941) 693-8200 Fax (941) 693-9702

TRAVEL EASY SALES & SERVICE

4299 HWY. 441 SOUTH
OKEECHOBEE FL 34974
(941) 467-0400 Fax (941) 467-9396

TRI AM RV CENTER INC.

5441 N.E. JACKSONVILLE ROAD
OCALA FL 34479
(352) 732-6269 Fax (352) 368-7992
GEORGIA

DICK GORE'S RV WORLD INC.

250 LONGWOOD DRIVE
RICHMOND HILL GA 31324
(912) 756-6606 Fax (912) 756-6627

TRAVEL COUNTRY RV CTR. INC.

5355 MILL STORE RD.
LAKE PARK GA 31636
(912) 559-7924 Fax (912) 559-4757

IDAHO

AMERICAN WAY RV CENTER

4033 CHINDEN BLVD.
BOISE ID 83714
(208) 345-6644 Fax (208) 345-5540

ILLINOIS

COLLIER RV CENTER

3510 MERCHANDISE DRIVE
ROCKFORD IL 61109
(815) 874-7188 Fax (815) 874-9426

LARRY'S TRAILER SALES

HWY. 148 NORTH
ZEIGLER IL 62999
(618) 596-6414 Fax (618) 596-6344

R & S SALES & SERVICE

218 S. LAKE OF THE WOODS ROAD
MAHOMET IL 61853
(217) 586-2055 Fax (217) 586-2382

INDIANA

ALL BRAND RV SERVICE

2717-B OAKLAND AVE.
ELKHART IN 46517
(219) 294-2363 Fax (219) 522-2251

DONS CAMPER SALES

U.S. 41 S. BOX 373
BOSWELL IN 47921
(765) 869-5009 Fax (765) 869-5009

HART CITY RV SERVICE

2300 S. NAPPANEE STREET
ELKHART IN 46517
(219) 295-5793 Fax (219) 295-6190

INDY RV CENTER

457 KNIGHT DR.
GREENWOOD IN 46142
(317) 881-0300 Fax (317) 881-0431

PREMIER RV

1400 LEISURE WAY
CLARKSVILLE IN 47129
(812) 284-1400 Fax (812) 283-3465

TERRY'S RV SALES & SERVICE

2900 E. CR 350 NORTH
MUNCIE IN 47303
(765) 289-9704 Fax (765) 289-9737

TOM STINNETT HOLIDAY RV. CTR.

520 MARRIOTT DRIVE
CLARKSVILLE IN 47129
(812) 282-7718 Fax (812) 285-7578

WETNIGHT RV SALES & SERVICE

4401 US 41 NORTH
TERRE HAUTE IN 47805
(812) 466-3961 Fax (812) 466-6851

IOWA**HEROLD TRAILER SALES**

1806 W. 2ND AVE., HWY. 92 WEST
INDIANOLA IA 50125
(515) 961-7405 Fax (515) 961-3674

WALKER TRAILER SALES INC.

HWY. 18 WEST, BOX 633
NORA SPRINGS IA 50458
(515) 749-2321 Fax (515) 749-2379

KANSAS**A & R**

16685 ORCHARD LANE
STILWELL KS 66085
(913) 681-5446 Fax (913) 681-5446

HARPER CAMPERLAND

1200 E. 10TH
GREAT BEND KS 67530
(316) 792-5170 Fax (316) 792-8466

HARPER CAMPERLAND

117 W. 14TH
HARPER KS 67058
(316) 896-2862 Fax (316) 896-2858

JAYHAWK CAMPER SALES

24105 W. 43RD
SHAWNEE KS 66226
(913) 422-5677 Fax (913) 422-7147

WILCOX HOMES & RV CENTER

835 NORTH EAST HWY. 24
TOPEKA KS 66608
(785) 357-5111 Fax (785) 232-1574

KENTUCKY**HALL ENTERPRISES**

975 BEASLEY STREET
LEXINGTON KY 40555
(606) 233-1777 Fax (606) 254-1073

SUMMIT RV SALES INC.

6917 US 60
ASHLAND, KY 41102
(606) 928-6795 Fax (606) 928-4102

TOM STINNETT

9213 DIXIE HWY.
LOUISVILLE, KY 40272
(502) 933-3345 Fax (502) 933-5626

YOUNGBLOOD RV CENTER INC.

2132 STATE ROUTE #45 NORTH
MAYFIELD KY 42066
(270) 247-8591 Fax (270) 247-0604

LOUISIANA**HOPE'S CAMPER CORNER INC.**

6120 FRONTAGE ROAD
MONROE LA 71202
(318) 345-1691 Fax (318) 345-0224

JACKIE EDGAR RV CENTER

3018 N.E. EVANGELINE THRUWAY
LAFAYETTE LA 70507-3425
(3180) 232-1941 Fax (318) 232-1950

MILLER RV

12912 FLORIDA BLVD.
BATON ROUGE LA 70815
(504) 275-2940 Fax (504) 275-6807

MAINE**MOUNTAIN ROAD RV**

31 MOUNTAIN ROAD
SABATTUS ME 04280
(207) 375-4091 Fax (207) 375-4014

MARYLAND**BECKLEY'S CAMPING CENTER**

11109 ANGLEBERGER ROAD
THURMONT MD 21788
(301) 898-3300 Fax (301) 898-1017

MASSACHUSETTS**STEARNS RV SALES**

71 MECHANIC ST.
BELLINGHAM MA 02019
(508) 966-1220 Fax (508) 966-3408

MICHIGAN**BEECH GROVE TRAILER SALES**

51439 M 40 NORTH
MARCELLUS MI 49067
(616) 646-7845 Fax (616) 646-2012

ERNIES RV SALES & SERVICE INC.

1066 STEPKE CT.
TRAVERSE CITY MI 49684
(231) 943-9111 Fax (231) 943-4441

GAYLORD RV SALES & SVC

271 WEST JOHNSON ROAD
GAYLORD MI 49735
(517) 732-6141 Fax (517) 731-2735

GENERAL RV CENTER

17277 RANCHO ROAD
BROWNSTOWN TWP MI 48192
(734) 284-5500 Fax (734) 284-5568

GENERAL TRAILER SALES

24583 N. RIVER ROAD
MT. CLEMENS MI 48043
(810) 954-3600 Fax (810) 959-4802

GENERAL TRAILER SALES

5300 HIGHLAND ROAD
WATERFORD MI 48327
(248) 674-0346 Fax (248) 674-3809

GENERAL TRAILER SALES

48500 12 MILE ROAD
WIXOM MI 48393
(248) 349-0900 Fax (248) 349-7965

HILLTOP RV SUPERSTORE

2905 N. LINCOLN ROAD
ESCANABA MI 49829
(906) 786-7986 Fax (906) 786-3421

INTERNATIONAL RV WORLD INC.

2717 E. DELTA ROAD
BAY CITY MI 48706
(517) 667-9840 Fax (517) 667-9843

KITSMILLER RV

1211 N. CEDAR
MASON MI 48854
(517) 694-7500 Fax (517) 694-3542

MIDWAY MOTOR HOMES

5590 S. DIVISION AVE.
GRAND RAPIDS MI 49548
(616) 534-9641 Fax (616) 534-6869

MODERN TRAILER SALES

3449 S. DIVISION AVE.
GRAND RAPIDS MI 49548-2110
(616) 241-2925 Fax (616) 241-5451

RANCH RV SALES INC.

6825 HWY. M-68
ALANSON MI 49706
(231) 548-5443 Fax (231) 548-2202

TC RV INC.

705 N. US 31 SOUTH
TRAVERSE CITY MI 49684
(231) 943-4050 Fax (231) 943-4075

MINNESOTA**HILLTOP TRAILER SALES**

7810 UNIVERSITY AVE. NORTHEAST
MINNEAPOLIS MN 55421
(612) 571-9103 Fax (612) 571-2536

THERMO LEASING CORP.

8390 HWY. 10 NORTH WEST
ANOKA MN 55303
(612) 421-2505 Fax (612) 421-6076

MISSISSIPPI**AMERICAN RV CENTERS, INC.**

8150 CRAFT ROAD
OLIVE BRANCH MS 38654
(601) 893-3040 Fax (601) 893-3044

RV REPAIR & SALES

4749 HWY. 80 WEST
JACKSON MS 39209
(601) 922-9425 Fax (601) 922-5153

MISSOURI**CAPETOWN R V SALES**

155 & AIRPORT ROAD
CAPE GIRARDEAU MO 63702
(573) 334-7152 Fax (573) 334-9059

COACHLIGHT RV SALES

5327 S. GARRISON AVE.
CARTHAGE MO 64836
(417) 358-7444 Fax (417) 358-0856

FRANK REED RV

HWY. 47 NORTH
ST. CLAIR MO 63077
(636) 583-2244 Fax (636) 583-2147

K C TRAILER SALES

11520 S. 71 HWY.
KANSAS CITY MO 64137
(816) 761-1393 Fax (816) 761-7722

THOMAS BILL CAMPER SALES

5217 N. LINDBERGH
ST. LOUIS MO 63044
(314) 731-2217 Fax (314) 731-0269

MONTANA**BRETZ RV & MARINE**

RESERVE STREET AT I-90
4800 GRANT CREEK ROAD
MISSOULA MT 59808
(406) 541-4800 Fax (406) 541-4813

NEBRASKA**RICH & SONS CAMPER SALES**

5112 S. ANTELOPE DRIVE
GRAND ISLAND NE 68803
(308) 384-2040 Fax (308) 384-2043

NEVADA**WHEELERS LAS VEGAS RV**

13175 LAS VEGAS BLVD. SOUTH
LAS VEGAS NV 89124
(702) 896-9000 Fax (702) 896-4504

NEW HAMPSHIRE

CH DANA RV SALES & SVC
628 WOODSVILLE RD.
MONROE NH 03771-3328
(603) 638-2200 Fax (603) 638-2066

CAMP AMERICA
222 PLAISTOW ROAD, RTE. 125
PLAISTOW NH 03865
(603) 382-9296 Fax (603) 382-1060

MOUNTAIN VALLEY RECREATION
410 MAIN STREET
GORHAM NH 03581
(603) 466-3868 Fax (603) 466-2416

NEW JERSEY

SCOTT MOTOR COACH SALES
1133 ROUTE 88
LAKEWOOD NJ 08701
(732) 370-1022 Fax (732) 905-0993

NEW MEXICO

ALOHA RV
11200 CENTRAL S.E.
ALBUQUERQUE NM 87123
(505) 298-8444 Fax (505) 275-7687

AMERICAN RV & MARINE
11810 CENTRAL S.E.
ALBUQUERQUE NM 87123
(505) 293-1983 Fax (505) 293-6991

AMERICAN RV & MARINE
200 NORTH TELSORE BLVD
LAS CRUCES NM 88011
(505) 522-5512 Fax (505) 522-3781

NEW YORK

BALLARDS CAMPING CENTER
S - 5849 SOUTHWESTERN BLVD.
HAMBURG NY 14075
(716) 649-9654 Fax (716) 648-0340

FREEDOM RV OUTLET
103 SITTERLY ROAD
CLIFTON PARK NY 12065
(518) 371-1289 Fax (518) 371-3001

JOURNEYTIME TRAILERS INC.
940 MIDDLE COUNTRY ROAD
SELDEN NY 11784
(631) 698-0055 Fax (631) 736-6622

SEVEN O'S
7917 DEVAUL ROAD
KIRKVILLE NY 13082
(315) 687-9342 Fax (315) 687-7992

WES TRAILER SALES
6166 ROUTE 25
WADING RIVER NY 11792
(631) 727-5852 Fax (631) 727-5396

WILKINS RV INC.
1099 ALMOND ROAD
HORNELL NY 14843
(607) 324-1313 Fax (607) 324-1082

WRATTEN TRAILER SALES
9209 ROUTE 11 SOUTH
ADAMS NY 13605
(315) 232-4535 Fax (315) 232-3445

NORTH CAROLINA

CAMPTOWN RV
12856 US HWY. 70 WEST
CLAYTON NC 27520
(919) 553-7277 Fax (919) 553-2716

HOWARD RV CENTER
6811 MARKET STREET
WILMINGTON NC 28405
(910) 791-5371 Fax (910) 392-0672

OLD TOWN CAMPER SALES
5109 NORTH CAUSEWAY DRIVE
WINSTON-SALEM NC 27106
(336) 924-9864 Fax (336) 922-1458

NORTH DAKOTA

CAPITAL RV CENTER
1900 N. BISMARCK EXPY.
BISMARCK ND 58501
(701) 255-7878 Fax (701) 255-1678

OHIO

AMOS MOTOR & RV
109 S MAIN STREET
BRADNER OH 43406
(419) 288-2700 Fax (419) 288-3273

ARBOGAST RV DEPOT
3540 SOUTH COUNTY ROAD 25A
TROY OH 45373
(937) 335-0068 Fax (937) 335-0471

BEGGS MOTOR HOMES
11197 CLEVELAND AVE NORTH WEST
P.O. BOX 545
UNIONTOWN OH 44685
(330) 499-9755 Fax (330) 499-6002

COLERAIN RV
3491 STRUBLE ROAD
CINCINNATI OH 45251
(513) 923-3600 Fax (513) 245-5145

FARBER MOTORS
5858 SCARBOROUGH BLVD.
COLUMBUS OH 43232
(614) 864-7878 Fax (614) 864-7899

OKLAHOMA

DAVE'S CLAREMORE RV
1400 S. LYNN RIGGS
CLAREMORE OK 74017
(918) 341-0114 Fax (918) 341-8936

DEAN'S RV SUPERSTORE INC
9955 EAST 21ST
TULSA OK 74129
(918) 664-3333 Fax (918) 664-8643

LEE'S RV CITY
13111 N. BROADWAY EXT.
EDMOND OK 73083-6250
(405) 936-9300 Fax (405) 936-9323

LEWIS TRAVEL TRAILER SALES
11518 E. 66TH ST.
OWASSO OK 74055
(918) 272-1353 Fax (918) 272-5451

OREGON

ALL SEASONS RV & MARINE
63195 JAMISON STREET
BEND OR 97708
(541) 382-5009 Fax (541) 382-8510

EUGENE RECREATION SALES
1700 HWY. 99 NORTH
EUGENE OR 97402
(541) 688-4849 Fax (541) 688-1885

OLINGER TRAVEL HOMES
6503 ALEXANDER
HILLSBORO OR 97123
(503) 649-2141 Fax (503) 642-9579

OLINGER TRAVEL HOMES
9401 S. E. 82ND
PORTLAND OR 97266
(503) 771-2121 Fax (503) 771-4638

TRIPLE A RV CENTER INC.
938 CHEVY WAY
MEDFORD OR 97504
(541) 772-1938 Fax (541) 779-1460

PENNSYLVANIA

ANSLEY RV
1280 ROUTE 764
DUNCANSVILLE PA 16635
(814) 695 9817 Fax (814) 695-9814

COUNCIL CUP TRAILER SALES
ROUTE 239
WAPWALLOPEN PA 18660
(570) 379-3751 Fax (570) 379-2913

HAROLD'S RV CENTER
7514 BETH BATH PIKE
BATH PA 18014
(610) 837-9880 Fax (610) 837-9473

R D KENNEDY SALES & SERVICE
1394 OLD YORK ROAD
DILLSBURG, PA 17019
(717) 432-9741 Fax (717) 432-1400

ROLLING WHEELS RV
2314 LYCOMING CREEK ROAD
WILLIAMSPORT PA 17701
(570) 322-1894 Fax (570) 322-1902

RHODE ISLAND

ARLINGTON RV SUPER CENTER
966 QUAKER LANE
EAST GREENWICH RI 02818
(401) 884-7550 Fax (401) 885-4566

SOUTH CAROLINA

TONY'S RV PARTS & SERVICE INC
130 POND BRANCH RD
LEXINGTON SC 29073
(803) 894-3071 Fax (803) 894-5385

SOUTH DAKOTA

SCHAAP'S TRAVELAND
3100 W. RUSSELL
SIOUX FALLS SD 57107
(605) 332-6241 Fax (605) 332-5422

TENNESSEE
AMERICAN RV CENTERS
4050 N. THOMAS
MEMPHIS TN 38127

(901) 353-1999 Fax (901) 353-1888
BENTON RV CENTER
7264 GEORGETOWN RD. NORTH WEST
CLEVELAND TN 37312
(423) 339-2811 Fax (423) 614-5518

TEXAS

CAMPER COACHES
1701 SOUTH LOOP 289
LUBBOCK TX 79423
(806) 748-7274 Fax (806) 748-7277

EAST TEXAS RV SALES
P.O. BOX 250
KIRBYVILLE TX 75956
(409) 423-4032 Fax (409) 423-5824



HILLTOP TRAVEL TRAILERS

850 W. RED OAK ROAD
 RED OAK TX 75154
 (972) 299-5074 Fax (972) 617-7065

PRO-TECH RV SERVICE CENTER

1620 N. 123 BYPASS
 SEGUIN TX 78155
 (830) 379-4100 Fax (830) 379-6812

PROFESSIONAL SALES

1809 JOHN MCCAIN ROAD
 COLLEYVILLE TX 76034
 (817) 488-9542 Fax (817) 488-1523

RON HOOVER CO.

29277 L.H. 10 WEST
 BOERNE TX 78006
 (830) 755-2252 Fax (830) 755-8644

RON HOOVER CO.

5029 COLUMBIA STREET
 CORPUS CHRISTI TX 78416
 (361) 854-5383 Fax (361) 851-9578

RON HOOVER CO.

16465 KATY FREEWAY
 HOUSTON, TX 77094
 (281) 829-1560 Fax (281) 829-9562

RON HOOVER CO.

1510 W. MARKET STREET
 ROCKPORT TX 78382
 (361) 729-9695 Fax (361) 729-9698

VOGT MOTOR HOMES

5624 AIRPORT FREEWAY
 FORT WORTH TX 76117
 (817) 831-4222 Fax (817) 838-5574

UTAH**BLAINE JENSEN & SONS RV CTRS.**

780 N. 900 WEST
 KAYSVILLE UT 84037
 (801) 544-4298 Fax (801) 544-3685

ESQUIRE RV

1285 W. 600 SOUTH
 VERNAL UT 84078
 (435) 789-4859 Fax (435) 781-9946

VERMONT**PETE'S RV CENTER**

4016 WILLISTON ROAD
 S. BURLINGTON VT 05403
 (802) 864-9350 Fax (802) 862-4806

VIRGINIA**CAMP - A - RAMA**

1107 N. GEORGE WASHINGTON HWY.
 CHESAPEAKE VA 23323
 (757) 487-8113 Fax (757) 485-2736

KOGLER SALES & SERVICE

ROUTE 2
 FISHERSVILLE VA 22939
 (540) 942-5556 Fax (540) 943-0853

VIRGINIA RV SALES, INC.

7023 ROUTE 17
 YORKTOWN, VA 23692
 (757) 898-5700 Fax (757) 890-0387

WASHINGTON**AL'S I-5 RV INC.**

2039 MOORE STREET
 BELLINGHAM WA 98226
 (360) 676-1515 Fax (360) 714-1447

FAMILY FUN RV

6722 PACIFIC HWY. EAST
 TACOMA WA 98424-1541
 (253) 926-6371 Fax (253) 926-6375

KORUM MOTORS

500 RIVER ROAD
 PUYALLUP WA 98371
 (253) 845-6600 Fax (253) 841-7620

MILESTONE RV CENTER

6722 EAST SPRAGUE AVE.
 SPOKANE WA 99212
 (509) 924-6446 Fax (509) 891-4131

RV OUTLET SUPERMALL

6407 NE 33RD
 MARYSVILLE WA 98271
 (360) 653-6100 Fax (360) 653-6200

WEST VIRGINIA**BRAND TRAILER SALES**

2045 FAIRMONT AVE.
 FAIRMONT WV 26554
 (304) 366-7104 Fax (304) 363-9345

SETZER'S WORLD OF CAMPING

5840 DAVIS CREEK ROAD
 BARBOURSVILLE WV 25504
 (304) 736-5287 Fax (304) 736-5992

WISCONSIN**FINNEGANS RV**

205 PARK AVE.
 BELOIT WI 53511
 (608) 365-2306 Fax (608) 365-3569

HORN'S SALES & SERVICE

8120 S. FRONTAGE ROAD
 SHEBOYGAN WI 53081
 (920) 564-2381 Fax (920) 564-2385

WYOMING**EASTSIDE MOTORS & RV'S INC.**

1200 E. SECOND ST.
 GILLETTE WY 82717
 (307) 686-1435 Fax (307) 682-1435

ALBERTA**MAJESTIC RV WORLD**

2777 SUNRIDGE BLVD. NORTH EAST
 CALGARY AB T1Y 3C2
 (403) 291-1203 Fax (403) 291-9561

VELLNER LEISURE PRODUCTS

1890 49 AVENUE
 RED DEER AB T4R 2N7
 (403) 343-1464 Fax (403) 340-8135

BRITISH COLUMBIA**JIM BOTTOMLEY'S RV WORLD**

1834 BYLAND ROAD
 KELOWNA BC V1Z 3E5
 (250) 769-3688 Fax (403) 769-3899

MIDTOWN MOTORS LTD.

64 INDUSTRIAL AVE. WEST
 PENTICTON BC V2A 6M2
 (250) 492-5705 Fax (250) 492-0430

N R MOTORS LTD.

805 1ST AVE.
 PRINCE GEORGE BC V2L 2Y4
 (250) 563-8891 Fax (250) 563-6315

TRAVELAND RV SUPERCENTER

20529 LANGLEY BY PASS
 LANGLEY BC V3A 5E8
 (604) 530-8141 Fax (604) 530-9576

TRIANGLE RV CENTRE LTD.

10299 MC DONALD PARK ROAD
 SIDNEY BC V8L 5X7
 (250) 656-1122 Fax (250) 656-2161

MANITOBA**WALT'S TRAILER SALES LTD.**

5195 PORTAGE AVE.
 HEADINGLY MB R4H 1E1
 (204) 837-8388 Fax (204) 831-8674

NEW BRUNSWICK**CAMPERS ALLEY LTD.**

11 BOURQUE ST.
 BOUCTOUCHE NB E4S 2X7
 (506) 743-8404 Fax (506) 743-6855

ONTARIO**1000 ISLANDS RV CENTRE**

409 CR #2, R.R. #2
 GANANOQUE ON K7G 2V4
 (613) 382-4400 Fax (613) 382-2466

FRONTIER RV

4131 HWY 115-35
 984 FINLEY AVE.
 ORONO ON L0B 1M0
 (905) 983-8000 Fax (905) 983-5746

WILLIAM PATTERSON RV SALES

28359 PIONEER LINE
 R.R. #1
 DUTTON ON N0L 1J0
 (519) 762-2125 Fax (519) 762-3386

QUEBEC**RAYMOND LEBLANC**

1275 DES LAURENTIDES BLVD.
 VIMONT LAVAL PQ H7M 2Y2
 (450) 663-7941 Fax (450) 663-2213

SASKATCHEWAN**D J'S RV CENTRE LTD.**

THATCHER DRIVE EAST & #1 HWY.
 MOOSE JAW SK S6H 4N9
 (306) 694-6048 Fax (306) 694-1221

5/9/00

CHAPTER 2

DRIVING & SAFETY PRECAUTIONS

Table of Contents

Safety Precautions	2 - 1
General Warning	2 - 1
Before Starting Out	2 - 2
Driving	2 - 2
LP Gas & Fuel	2 - 3
LP Gas System	2 - 3
LP Regulator	2 - 4
LP Distribution Lines	2 - 4
Fire Safety	2 - 5
Fire Extinguisher	2 - 5
Smoke Detector	2 - 6
Emergency Exit Window	2 - 6
Weight Information	2 - 6
Weighing the Unit	2 - 7
Campsite Parking	2 - 8
Car Towing Hitch	2 - 9

SAFETY PRECAUTIONS

WARNING

Prior to driving your vehicle, be sure you have read this entire owner's guide and that you understand your vehicle's equipment completely and how to use the equipment safely.

Read and understand all of the instructions and precautions in this owner's guide and the chassis manufacturer owner's manual before operating your new motorhome. Listed below are some safety precautions that must be adhered to while your motorhome is in motion. These precautions, as well as others that involve possible damage to equipment, are also listed in the appropriate areas in this manual.

General Warning

WARNING

Portable fuel-burning equipment, including wood and charcoal grills and stoves, shall not be used inside the recreational vehicle. The use of this equipment inside the recreational vehicle may cause fires or asphyxiation.

- Seats equipped with seat belts are the only ones to be used while the vehicle is in motion.
- While the vehicle is in motion, all seats should be locked in the forward facing position.
- Passengers should never be allowed to stand or kneel on seats in a moving vehicle.
- All passengers must have seat belts fastened in a low and snug position so that the force exerted by the belt in a collision will be spread across the hip area. Pregnant women should wear the lap-shoulder belt, with the lap belt portion worn low and snug.
- The fire extinguisher should be inspected monthly for proper charge and operating condition. The smoke alarm should also be tested on a regular basis. The label on the detector should be removed when preparing the unit for the first trip. In addition to the recommended inspection, these should also be checked prior to a vacation or extended trip.
- Sleeping facilities are not to be used while the vehicle is in motion.
- Become familiar with the operation of the escape window, but use this window strictly as an emergency exit.

Before Starting Out

The following is a brief list of procedures that will aid in your driving safety and extend your equipment's life.

- Windows, mirrors, and light lenses are to be clean and unobstructed.
- Tires should be checked for proper cold inflation pressure.
- Wheel lug nuts should be checked for proper tightness.
- Fluid levels, including engine oil, transmission fluid, coolant, power steering fluid, brake fluid, and windshield washer solvent, should be checked and filled if necessary.
- Disconnect the unit and store the sewer and water supply hoses as well as shoreline power cords.
- Secure all cargo in the storage compartments in the event of a sudden stop.
- Verify that the step has retracted prior to engine ignition.

Driving

There are various adjustments that need to be made prior to starting and moving the vehicle.

- Among them are the driver's seat, the tilt steering, and the exterior rear view mirrors.
- The dashboard may contain several gauges and controls you have not previously used. Become familiar with all of these devices and their operation before starting out.
- The cruise control is not to be operated on icy roads, extremely wet roads, winding roads, heavy traffic, or in any other traffic situation where a constant speed cannot be maintained.
- While driving on slippery surfaces, use care when accelerating or decelerating. Skidding and loss of vehicle control may be the result of abrupt changes in speed.
- Driving through water deep enough to wet the brakes may affect the stopping distance or cause the vehicle to pull to one side. If you have driven through deep water, check the brake operation in a safe area to be sure they have not been affected. Never operate a vehicle if a difference in braking efficiency is noticeable.
- Extreme terrain and adverse weather may affect the handling and/or performance of your vehicle. Please refer to your chassis manual for related information.

Notes

LP Gas & Fuel

WARNING

LP gas containers, gasoline or other flammable liquids shall not be placed or stored inside the vehicle because fire or explosion may result. LP gas containers are equipped with safety valves that relieve excessive pressure by discharging gas into the atmosphere.

- While refilling the fuel or LP tank, the engine must be off, all pilot lights must be extinguished, and appliances turned off. Smoking is also prohibited at this time.
- Exhaust gases contain carbon monoxide (an odorless, colorless, and poisonous gas). These gases are produced by burned gasoline, diesel, or LP gas. Items such as the range, furnace, water heater, refrigerator, chassis engine, or generator engine can produce these gases. These fumes should not be inhaled. Inhaling carbon monoxide may produce headaches, dizziness, nausea, or even death.
- An open flame is never to be used to test for LP gas leaks.
- All protective covers and caps must be replaced after filling the LP system.
- Once the valve is closed, securely latch the LP door.
- LP gas and natural gas are not interchangeable. Never connect natural gas to the LP gas system.
- The use of equipment such as wood and charcoal grills and stoves inside this recreational vehicle may cause fires or asphyxiation.

LP GAS SYSTEM

General Information

A warning label has been placed near the LP gas container. This label reads:

WARNING

DO NOT FILL CONTAINER(S) TO MORE THAN 80 PERCENT OF CAPACITY

Overfilling the LP gas container can result in uncontrolled gas flow, which can cause fire or explosion. A properly filled container will contain approximately 80 percent of its volume as liquid LP gas.

The LP gas system components in your unit have been approved for use in camping vehicles by a nationally recognized testing laboratory. LP gas is a clean-burning dependable fuel when properly handled. The LP gas tank mounted on your unit contains liquid propane gas under high pressure. The liquid gas vaporizes as the fuel is used and passes through the tank valve

to a regulator that automatically reduces the pressure. The low-pressure gas is then distributed to the appliances through the pipe manifold system. Appliance lighting problems are commonly caused by an improperly adjusted gas regulator. Never attempt to reset the regulator yourself. Have an authorized service technician make any necessary adjustments. We recommend that you have the LP gas system checked by an authorized service technician at least once a year and after every extended trip. Although the manufacturer and dealer carefully test for leakage, travel vibrations could loosen fittings. Leaks can be easily found by applying leak detector solution at the connections. If leak detector solution is not available, a soapy water solution made with dish soap can be used. Tightening the fitting usually stops any leaks. If this does not work, shut off the main gas valve at the tank and immediately consult an authorized service technician for repairs. If a leak is suspected, the identifying odor smells similar to rotten eggs (sulfur). Never test for a leak by lighting a match or having an open flame where you suspect leaking gas.

WARNING

Shut off the main gas valve at the tank when the camping vehicle is not in use. Also, shut off the valve when refueling to avoid potential danger from pilot lights igniting fuel fumes. Some appliances, such as the refrigerator, water heater, and furnace, have DSI (direct spark ignition) boards, so it is important that you turn the appliances off when the LP gas is off. The ignition in the appliances will continue to spark even if there is no LP gas available.

LP Regulator

The regulator acts as the heart for the LP gas system. The LP gas in the tank is under high pressure. The regulator reduces the pressure of this gas so that it is safe to use with the various appliances in your unit. If corrosion is noticed, contact a qualified LP gas service technician. Do not adjust the regulator. It is factory preset. Adjustments are to be made by a qualified LP service technician using specialized equipment.

LP gas regulators must always be installed with the diaphragm vent facing downward. Regulators that are not in compartments have been equipped with a protective cover. Make sure that the regulator vent faces downward and that the cover is kept in place to minimize the vent blockage that could result in excessive gas pressure causing fire or explosion.

LP Distribution Lines

The primary manifold is a black steel pipe running the length of your unit. Most secondary lines leading to gas appliances are made of copper tubing with flare fittings. If any of the gas lines rupture, do not attempt to splice them. Always run a new line. We recommend gas distribution work be performed by an authorized service technician. The main valve at the LP tank must be closed when removing or servicing any gas appliance. This will prevent dangerous gas leakage that could result in an explosion and possibly serious injury. If a leak is suspected, have the systems inspected and repaired by a qualified service technician.

Precautions & Recommendations

- Inspect the LP fill valve for foreign materials before refueling.
- Shut the pilot lights off prior to refueling LP gas tanks.
- Never check for gas leaks with an open flame (match, etc.).
- Gas lines should be visually inspected periodically.
- Have the gas system inspected yearly and before and after extended trips.
- The gas system should be inspected and repaired by qualified technicians only.

WARNING

The LP system in your recreational vehicle is designed for liquefied petroleum gas only. Never attempt to connect natural gas or butane gas in this system.

FIRE SAFETY

The possibility of fire exists in all areas of life, and the recreational life-style is no exception. Recreational vehicles are complex machines. They are made up of many materials, some of which are flammable. Like most hazards, the possibility of fire can be minimized, if not totally eliminated. This is done by recognizing the danger and practicing common sense safety and maintenance habits. For safety reasons, your unit is furnished with both a fire extinguisher and a smoke alarm.

Fire Extinguisher

The fire extinguisher is rated for Class B (grease, gasoline, diesel fuel, flammable liquids) and Class C (electrical) fires. These are the most common types of fires in vehicles. Read the operator's manual and the instructions on the fire extinguisher. Be sure to know how and when to use the extinguisher and where it is located.

Fire extinguishers are mechanical pressurized devices. Care must be exercised when they are handled. They must be maintained as the operator's manual instructs for proper and safe operation. The extinguisher should be inspected at least once a month. More frequent inspections may be required if the extinguisher is exposed to the weather or to possible tampering. Do not test the extinguisher by partially discharging. Doing this will cause a loss of pressure.

If a fire occurs in the vehicle, evacuate the vehicle as quickly and as safely as possible. Consider the cause and the severity of the fire and the risk involved before trying to extinguish it. If the fire is major or fuel fed, move away from and stand clear of the vehicle and wait for emergency assistance to arrive.

Smoke Detector

The battery powered smoke detector is mounted on the ceiling in the living area of the unit. Read the operating instructions for details on the testing and care for this important safety device. Test the smoke detector after the unit has been in storage, before each trip, and at least once a week during use. The detector should never be disabled because of nuisance or false alarm from cooking smoke or a dusty furnace. Ventilate the unit with fresh air and the alarm will shut off. Never disconnect or remove the battery from the smoke alarm. The battery should be replaced once a year or when the low battery signal sounds.

Emergency Exit Window

In the bedroom of the unit, there is an emergency exit (egress) window. This window is designed to be used as an additional exit in emergency situations. It can be easily identified by the red color of the handle and the red "EXIT" label. To open the egress window, lift the handle and push outward on the window. The window can be closed by pulling the window closed and lowering the handle to the down or locked position.

WEIGHT INFORMATION

Below is a sample of a weight information label which may appear in your unit.

MOTORHOME WEIGHT INFORMATION			
Newmar Serial Number	xxxxxxx	VIN #	xxxxxxxxxxxxxxxxxxxxxxxx
Model	xxxxxxxxxxx		
GVWR	xxxxxxx		
UVW	xxxxxxx		
NCC	xxxxxxx		
GCWR	xxxxxx		

GVWR (Gross Vehicle Weight Rating) means the maximum permissible weight of this motorhome. The GVWR is equal to or greater than the sum of the Unloaded Vehicle Weight plus the Net Carrying Capacity.

UVW (Unloaded Vehicle Weight) means the weight of this motorhome as built at the factory with full fuel, engine oil, and coolants. The UVW does not include cargo, fresh water, LP gas, occupants, or dealer installed accessories.

NCC (Net Carrying Capacity) means the maximum weight of all occupants including the driver, personal belongings, food, fresh water, LP gas, tools, tongue weight of towed vehicle, dealer installed accessories, etc., that can be carried by this motorhome. (NCC is equal to or less than GVWR minus UVW)

GCWR (Gross Combination Weight Rating) means the value specified by the motorhome manufacturer as the maximum allowable loaded weight of this motorhome with its towed trailer or towed vehicle.

This motorhome is capable of carrying up to xxx gallons of fresh water (including water heater) for a total of xxxx pounds.
Reference: Weight of fresh water is 8.33 lbs/gal.

CONSULT OWNER'S MANUAL FOR SPECIFIC WEIGHING INSTRUCTIONS AND TOWING GUIDELINES.

Weighing the Unit

The following definitions are given to help in communications of issues of weight and your unit.

- GAWR:** Gross Axle Weight Rating means the maximum permissible weight for an axle. This takes into consideration the weakest link in the tire, wheel, brakes, hubs, axle, springs, and attaching parts. For example, if the axle is rated at 15,000 pounds and the tires are rated at 3,415 pounds each as a dual, the maximum GAWR would be 13,660 pounds with four tires.
- GCWR:** Gross Combined Weight Rating means the value specified by the manufacturer of the vehicle as the maximum allowable loaded weight of the vehicle with its towed trailer or towed vehicle.
- GVWR:** Gross Vehicle Weight Rating means the maximum permissible weight of this motorhome. The GVWR is equal to or greater than the sum of the Unloaded Vehicle Weight plus the Net Carrying Capacity.
- UVW:** Unloaded Vehicle Weight means the weight of the motorhome as built at the factory, with full fuel, engine oil, and coolants. The UVW does not include cargo, fresh water, LP gas, or dealer installed accessories.
- NCC:** Net Carrying Capacity means the maximum weight of all occupants, including the driver, personal belongings, food, fresh water, waste water, LP gas, tools, tongue weight of towed vehicle, dealer installed accessories, etc., that can be carried by the motorhome. NCC is equal to or less than the GVWR minus the UVW.
- GVW:** Gross Vehicle Weight is the weight of the unit with all items and supplies that are loaded into the unit at any point in time.

To assure the accuracy of your weights be sure the unit is always level during weighing.

The unit has been built to comply with the component suppliers recommended limits and give you a realistic NCC. When loading the unit, distribute the items so that not all of the weight is added to one area of the unit. If you have questions as to what the weight of the unit is after it has been loaded, take the unit to a drive-on scale or use individual wheel scales and verify that the weights are within the limits of those specified for the unit. When weighing the unit follow these instructions. Failure to follow these instructions may give an erroneous weight reading.

NOTE: The sales literature may give approximates or standards. Each individual unit may weigh differently based on the factory and/or dealer options added.

Notes

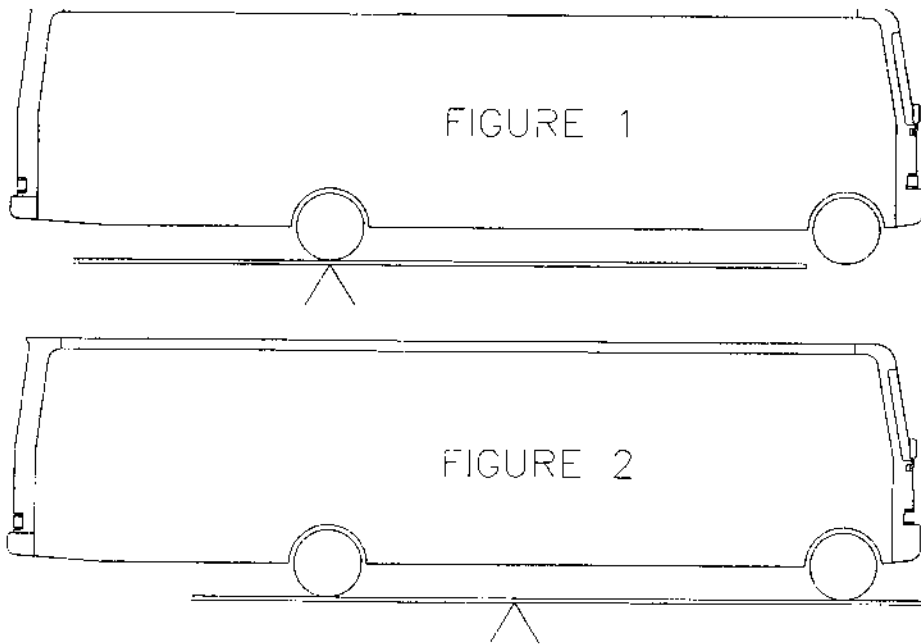

1. Pull the unit onto the scales as shown in Fig. 2, to get the total weight of the unit. To do this, pull the unit onto the scales so that all of the wheels are on the scale. Record the weight. This is the GVW and should not exceed the GVWR supplied by Newmar for the unit.
2. Move the unit so that the front wheels are off the scales as shown in Fig. 1. Try to keep the unit as level as possible. Record the weight. This is the total weight of the unit except for the front axle. This weight should not exceed the total rating of the axles remaining on the scales. The front axle weight is determined by subtracting this weight from the GVW that was obtained in step one (1). This amount should not exceed the listed front axle weight rating.

Campsite Parking

If the campground does not have drive-through sites, it is recommended to stop near the site and inspect it for slopes or uneven areas. Back into the site carefully. Watch for low-hanging limbs, posts, large rocks, or other obstacles. Back the unit in so the site is on the driver's left, if possible. This will enable the driver to watch the rear of the unit. Back up slowly using the side mirrors as a guide or with the assistance of another person outside guiding the parking procedure.

Place the vehicle in park and turn off the ignition. If parked on a steep incline, pre-level the coach by driving the appropriate wheels onto blocks. Finish the leveling process by using the leveling jack system to level and stabilize the unit. Connect the 120 volt shore power to the unit. Open the LP gas valves at the LP tanks. Connect the fresh water supply and sanitize the water systems, if necessary. Connect the waste drain hose to the sewer hook-up. Start the refrigerator, water heater, and furnace, if needed. Light the oven pilot light, if applicable. Remember that the refrigerator will not operate efficiently if the unit is unlevel.

CAUTION

Do not lift the wheels of the unit off the ground at any time during this process. The unit can roll forward or backward when the weight of the unit is on the jacks.

Car Towing Hitch

The motorhome is equipped with a 5,000 pound, class three hitch and wire connector. Your unit is designed for use as a recreational vehicle and is intended for towing light loads. The instructions for towing are listed in the chassis manufacturer owner's manual provided with your unit. The total weight of the motorhome and any vehicle towed by it must not exceed the GCWR. When weighing the motorhome, be sure to take passenger locations into consideration. The towed vehicles must have adequate active brakes. The wire connector installed is the standard seven-pin connector. Chapter 7 of this guide will have more information regarding this connector.

Notes

CHAPTER 3

AIR CONDITIONING & HEATING

Table of Contents

Air Conditioning	3 - 1
Furnace	3 - 2
LP Tank	3 - 3
LP Tank Filling	3 - 3
LP Regulator	3 - 4
LP Detector	3 - 4

AIR CONDITIONER(S)

The roof mounted air conditioner(s) which is installed on your coach will operate only when the unit is supplied with 120 volt AC power from the power cord or the generator. The air conditioner circuit breaker must be in the ON position to work.

To assist the air conditioner in cooling the coach, park in the shade and keep the drapes or blinds closed. Set the thermostat to the desired temperature.

Air conditioners can use a large portion of the available electric power. RV parks may experience low voltage on days with high heat or humidity. This is commonly referred to as a "brown out." A "brown out" may trip the air conditioner circuit breaker. The circuit breaker protects your air conditioner from damage and is necessary during low voltage conditions. The tripped breaker is not a fault in your electrical system.

The cool air from the air conditioner is ducted throughout the coach through ceiling air ducts. Below is the thermostat that controls the air conditioner. It also controls the furnace. Simply select the desired temperature. The blower will cycle automatically, or you may choose low, medium, or high fan settings.

If the coach is equipped with two air conditioners, both units must be in the same mode. Please consult the air conditioner manufacturer's Owner's Manual for further assistance.

Step One: Move power switch to ON.

Step Two: Press MODE button to select function. (COOL*, FURNACE, FAN ONLY, etc.)

* There is an approximate 2-minute time delay after selecting cooling function for refrigerant compressor to start.

Step Three: Press FAN button to select fan speed or automatic operation.

Step Four: Press UP or DN button to set your desired temperature for the zone.

Step Five: If your vehicle contains more than one zone, depress FAN and MODE simultaneously to select zone 2, and repeat procedures from step 2 above. Repeat entire procedure for each additional zone.

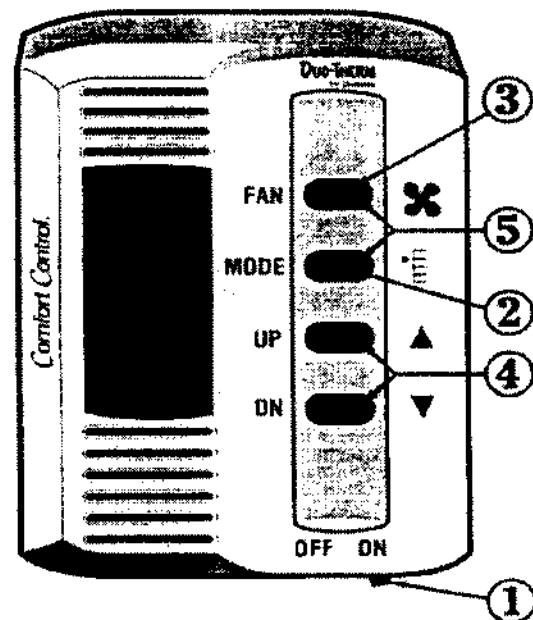

Shutdown: If you turn the Comfort Control off or if there is a power interruption for any reason, the system will resume operation on the last settings when power returns.

FURNACE

WARNING

Never attempt to modify this furnace. Fire, explosion, asphyxiation, or carbon monoxide poisoning may occur. If the furnace malfunctions, consult a trained service technician.

The furnace installed in your unit is a forced-air furnace fueled by LP gas. The furnace is controlled by the air conditioner wall thermostat. This thermostat controls both the heating and cooling of the coach.

The heat is supplied to the coach through ducts in the floor. The furnace will not operate properly if the air flow at the floor registers or the air return to the furnace is blocked by personal or storage items. Storage under the cabinets should be done carefully to prevent crushing or damaging the furnace ducting or blocking of the cold air return.

Smoke and fumes may be created as a result of the residual burn off of the manufacturing compounds that are sometimes present the first time the furnace is used. This is normal. To minimize the smoke and fumes, the initial lighting of the furnace should be done with the windows and doors open. Continue until the residue is completely "burned off."

To operate, set the thermostat to the desired temperature setting and turn the thermostat to the on position. Allow 60 seconds for the furnace to begin operating. To shut down the furnace, turn the thermostat to the off position. After the furnace has been turned off, the fan will run for approximately 60 seconds to cool down.

For your safety, do not use gasoline or other flammable liquids in the vicinity of the furnace or any other appliance. Clean the complete furnace and air tube passageways periodically to remove dust, lint, etc. Check the gas system for leaks at least once a year. Check and clean the blower wheel annually.

On the exterior of the coach you will find a furnace cover. There are no owner serviceable parts on the furnace. This cover should be removed by authorized service technicians only.

WARNING

Use caution when washing the exterior of your vehicle. Water should not be sprayed directly into the furnace vent. If water is forced beyond the rain baffles into the furnace vent, rusting of the furnace could occur. This could also cause improper combustion.

The furnace should be thoroughly cleaned before the start of each heating season. Any debris in the system may restrict air flow for combustion, bind the combustion air impeller, or prevent the blower motor from running properly. Also, check the burner pilot orifices for debris. Lint accumulations may cause the blower to become unbalanced, vibrate, or restrict the ability of the blower to move air. If the lint is blown into the heat exchanger, it may cause odors or create a fire hazard. Contact an authorized service technician for annual cleaning. Consult the manufacturer's operating instructions in your Owner's Packet for further information.

WARNING

Portable fuel burning appliances are not safe for heating inside the recreational vehicle. Asphyxiation or carbon monoxide poisoning can occur.

LP TANK

This unit is equipped with an ASME (American Society of Mechanical Engineers) approved LP tank. This tank is controlled with an automatic pressure regulator. The LP tank contains liquid petroleum gas under high pressure. As the fuel is used, the liquid gas vaporizes and passes through the tank valve to a regulator that automatically reduces the pressure. The low-pressure gas is then distributed to the appliances throughout the pipe manifold system. Improperly adjusted regulators are the major cause of appliance lighting problems. Never attempt to reset the regulator. This is to be done by a qualified service technician. While in high altitudes or extreme cold weather a gas shortage may be experienced. Running one appliance at a time can help adjust to this problem.

It is recommended to have the LP system inspected by an authorized service technician at least once a year, and after every extended trip. This system is tested by both the manufacturer and the dealer. Leaks can be caused by travel vibrations, therefore routine inspections are recommended.

The primary gas supply manifold is a black steel pipe running the length of the unit. Most secondary lines leading to the gas appliances are made of copper tubing with flare fittings. If any of these lines rupture do not attempt to splice them. Always have a new line run. Gas distribution work must be performed by an authorized service technician. When removing or servicing any gas appliance, close the main gas valve at the LP tank. This will prevent dangerous gas leakage that could result in an explosion and possible serious injury. If a gas leak is suspected, have the system inspected and repaired by a qualified service technician as soon as possible.

WARNING

The main gas valve must be shut when the vehicle is not in use. Shut the valve off when refueling to avoid potential danger from pilot lights igniting fuel fumes. Gas valves on appliances with direct spark ignition (DSI) should also be in the off position. Do not store LP, gasoline, diesel, or other flammable liquids inside the vehicle. Fire or an explosion could be the result of ignoring this warning.

LP Tank Filling

Do not fill the tank to more than 80 percent of capacity. The unit must be level when filling the LP tank. If unlevel, overfilling may occur. Fire or explosion may be the result of uncontrolled gas flow from an overfilled tank.

LP Regulator

The regulator is the heart of the LP system. The regulator reduces the pressure of the gas so it is safe to use with various appliances. Regulators are equipped with a vent. In the event excess pressure builds up in the body of the regulator, a relief mechanism vents it to the atmosphere. It will vent until the pressure returns to the normal range. The vent must be kept clean and clear of obstructions or corrosion. A clogged vent could cause the failure of components. Contact a qualified LP technician if corrosion or obstruction is noticed.

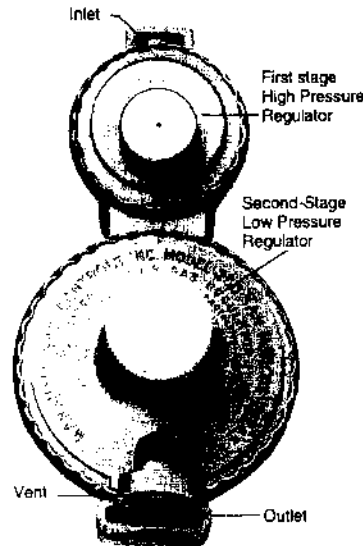

The presence of moisture in LP fuel causes the regulators to freeze. The moisture will pass through the cylinder valve and into the regulator where freezing occurs. To help prevent the regulator from freezing, always keep the tank control valve closed when not in use, even when the tank is empty, to prevent moisture from collecting on the inside.

If moisture becomes a problem, consult an authorized LP service center for assistance.

The regulator must always be installed with the diaphragm vent facing downward. Please refer to Chapter 2 of this manual for further LP gas safety information.

LP Gas Detector

WARNING

Never check gas lines for leaks with an open flame. Do not check for leaks using ammoniated or chlorinated household type detergents. These detergents can cause cracks to form on the metal tubing and brass fittings. Take the unit to a qualified LP gas service technician to find and repair the leak. Keep the tank valve closed and all of the appliances turned off when the unit is stored. If any of the LP gas valves do not close leak-tight by hand, consult a service technician.

Liquid Propane (LP) Gas is heavier than air and will settle to the lowest point of the room, which is generally the floor of your coach. Because of this, the LP detector installed in your coach is located near the floor. The detector is also sensitive to other fumes, such as hair spray, of which most contain butane as the propellant. Butane, like propane, is heavier than air and will settle to the floor level where it may be detected.

CHAPTER 4

APPLIANCES & ACCESSORIES

Table of Contents

Refrigerator	4 - 1
Microwave	4 - 2
Range Hood	4 - 2
Range	4 - 2
Television Antenna	4 - 3
Television	4 - 4
Video Cassette Recorder	4 - 4
Video Control Center	4 - 5
Cable & Telephone Jack	4 - 6
Stereo	4 - 6
Water Heater	4 - 6
Water Heater Storage	4 - 7
Pressure Relief Valve	4 - 7
CB Radio	4 - 8
Rear View Monitor System	4 - 8
Cellular Antenna	4 - 8
Washer & Dryer	4 - 9
Carbon Monoxide Detector	4 - 9

MAJOR APPLIANCES

Refrigerator

Before starting the refrigerator, verify that the main LP gas valve is in the on position. The refrigerator is equipped with a semi-automatic energy selector (AES) control system. It can be set to select either 120 volt or LP gas operation, automatically, if desired.

WARNING

Most LP gas appliances used in recreational vehicles are vented to the outside of the vehicle. When parked close to a gasoline pump it is possible that the gasoline fumes could enter this type of appliance and ignite the burner flame causing a fire or explosion. Use caution when refueling.

A 12 volt power supply must be available for the electronic control panel to function. The shore line must be plugged in, or the optional generator running, to operate in the 120 volt mode. The main LP gas valve must be open for operation in the LP mode. To start the refrigerator, press the main power ON/OFF button to the ON position.

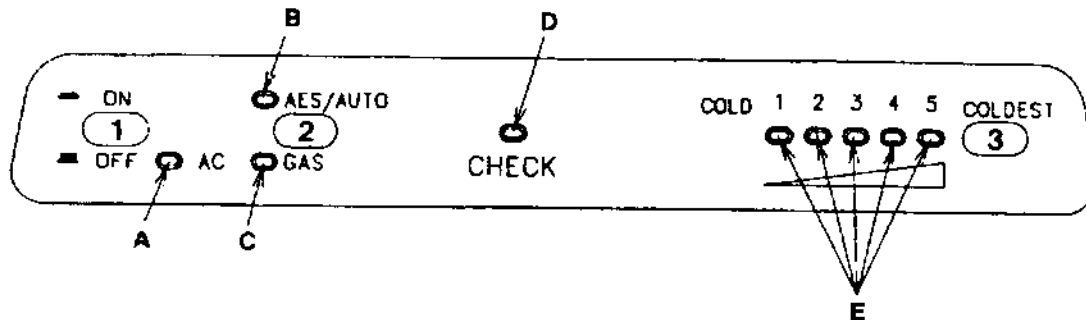

LEGEND 2-WAY AES Model

1. Main Power Button ON/OFF
2. AES/AUTO/GAS Mode Selector Button
3. Temperature Selector Button

- A. AC Mode Indicator Lamp
- B. AES/AUTO Mode Indicator Lamp
- C. GAS Mode Indicator Lamp
- D. CHECK Indicator Lamp
- E. Temperature Indicator Lamps

To use the 2-way Auto Mode, push the AUTO/GAS mode selector into the ON position. If 120 volt is available, the AC mode indicator light will be illuminated designating AC operation. If 120 volt is not available, the gas mode indicator light will be illuminated. The control system will automatically switch to gas operation. To operate on gas only, push the AUTO/GAS mode selector until the gas indicator light has lit. After 45 seconds the burner should be ignited and operating normally. The initial start up may take longer than 45 seconds in order to allow the air to be purged from the gas line. If the gas does not ignite within 45 seconds, the check indicator light will illuminate and the gas mode light will go off. If the check indicator light illuminates and the gas mode indicator light is off, then the controls have failed to ignite the burner in the gas mode. When the check indicator light is on, press the main power ON/OFF button to the off position to reset. Do not continue to reset the gas operation if the check indicator light continues to illuminate after several tries.

The thermostat on the refrigerator controls the gas and electric operation. This eliminates the necessity of resetting the temperature each time a different energy source is used. Press the

temperature selector button until the light at the desired setting is illuminated. After the initial start up, the thermostat should be moved from the coldest setting to the desired setting, which is usually mid range.

An additional optional feature on the Dometic refrigerator is the installation of the automatic ice maker in the freezer compartment. For detailed operating instructions, please consult the manufacturer owner's manual in the Owner's Package.

Microwave

A microwave is installed in your coach as part of the standard equipment package. In place of the standard microwave, a convection microwave may be optioned. All microwaves operate on 120-volt electricity. The microwave's control panel is the touch pad type. Simply enter the temperature, mode, and cooking time desired. The microwave is plugged into the electrical outlet through a surge protector. This will help protect the microwave in case of an electrical surge. For instructions on how to operate any of the special features on the microwave oven, please refer to the microwave owner's manual in your Owner's Package.

Range Hood

The standard range hood is a separate appliance installed above the range, below the microwave. This range hood has both a fan and a light for your convenience. It is operated by turning the switch for the light either on or off, and for the fan either low, high, or off. Consult the range hood owner's manual for further instruction on the hood operation.

Range

There is no pilot light for the range. The burners are controlled by a spark ignition. There are different models used in the Newmar product line with different types of controls. To light the burners on some models, turn the control knob to turn the gas on. Wait a couple of seconds, then push the red spark button until a flame appears. On other models turn the spark control knob until a flame appears. All burner controls operate counter clockwise and have to be pushed inward in order to turn. For further instructions, please refer to the oven manufacturer owner's manual in your Owner's Package.

The following warning label has been placed in the cooking area to remind the user to provide an adequate supply of fresh air for combustion:

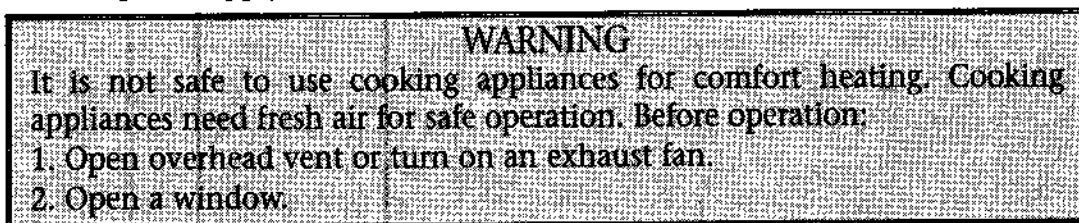

Unlike homes, the amount of oxygen supply is limited due to the size of the recreational vehicle. Proper ventilation when using the cooking appliance(s) will avoid dangers of asphyxiation. It is especially important that cooking appliances not be used for comfort heating as the danger of asphyxiation is greater when the appliance is used for long periods of time.

The following label has been placed in the vehicle near the range area:

If You Smell Gas:

1. Extinguish any open flames, pilot lights, and all smoking materials.
2. Do not touch electrical switches.
3. Shut off the gas supply at the tank valve(s) or gas supply connection.
4. Open doors and other ventilating openings.
5. Leave the area until the odor clears.
6. Have the gas system checked and leakage source corrected before using again.

TELEVISION OPERATION

AntennaTek Television Antenna

The TV antenna in your unit is designed for reception of all color and black-and-white channels. If the reception is poor, you should verify that the power switch is in the "ON" position and that all of the connectors are tight. If poor reception still occurs, consult your authorized dealer.

To raise the antenna into the operating position, rotate the elevation handle clockwise. A clicking sound will occur when the antenna is completely extended. Switch on the main power supply. Note the red LED indicator illuminated. This indicated amplified reception. Switch on the television and tune in a suitable station. Pull the rotation handle down to disengage the gear from the ceiling plate and rotate the antenna until the picture and sound are the clearest.

To lower the antenna, pull the rotation handle down to disengage the gear from the ceiling plate and rotate the antenna until the pointer on the ceiling plate is aligned with the pointer on the rotation handle. Rotate the elevation handle counter-clockwise until you hear the antenna touch the roof. Resistance will be felt in the handle.

CAUTION

Lowering the antenna with the pointers misaligned will damage the gears or the elevating handle.

You may want to switch your main power supply off. Amplified reception is possible if the antenna is in the full down position.

RAISING ANTENNA TO OPERATING POSITION

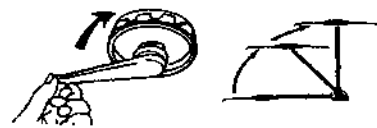

ROTATING ANTENNA FOR BEST PICTURE



LOWERING ANTENNA TO TRAVEL POSITION

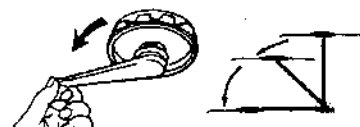

Video Control Center (Optional)

The Audio Video Control Center (AVCC) may be installed in your vehicle as part of the optional VCR Prep feature. The AVCC will direct the signal to one or two televisions and one VCR. Simply push a button to select what is viewed and where. To control what is being viewed on the front television use the selections for "TV 1." To control what is being viewed on the bedroom (and outside television, if desired) use the selections for "TV 2." Each television is capable of viewing different programming at the same time. For example, by selecting "ANT" for "TV 1" you are able to watch your favorite network broadcast on the front television,

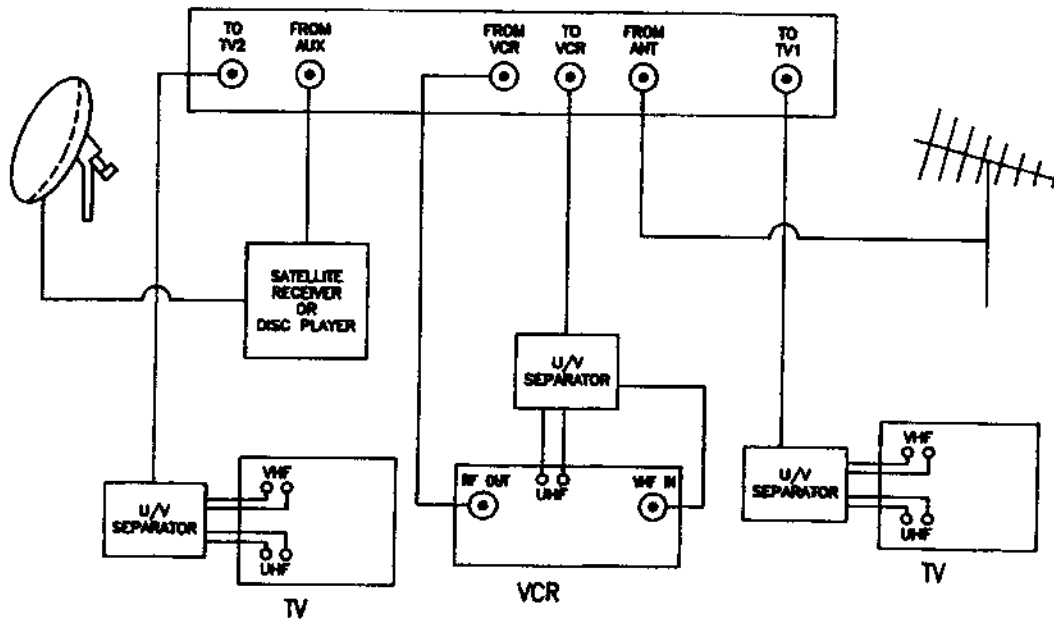

while a movie from the VCR is being watched in the bedroom or outside, after selecting the "VCR" button for "TV 2." This control center is capable of receiving three sources of input. They are "FROM ANTENNA," "FROM VCR," and "FROM AUX." The "FROM AUX" selection is used for cable input. It will also accommodate video game systems or a satellite dish.

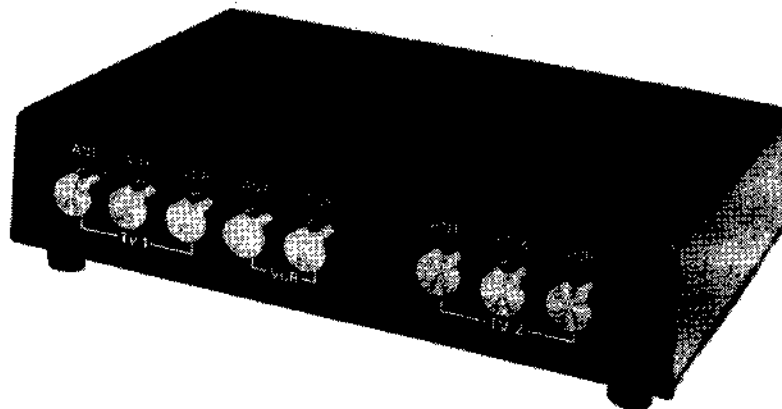

Cable & Telephone Jack

The exterior cable jack and receptacle are features on this coach, and are installed in the compartment beside the entrance door. Another feature on this coach is the telephone hook up. This will allow the user to connect the coach to a telephone cable, if the park is so equipped. This feature includes the connector for the incoming telephone line and one telephone outlet inside the coach. An additional interior telephone jack may be optioned.

Stereo

The standard dash stereo installed in your coach is an AM/FM stereo with a compact disc player. A cassette player is optional. The operation of this stereo is similar to that of many car stereos. The stereo operates on 12 volt electricity from the coach batteries. There are speakers located throughout the coach for listening pleasure. For further information on the operation of the stereo, consult the stereo manufacturer owner's manual in the Owner's Package.

WATER HEATER

WARNING

Do not light the water heater until it is filled with water. There is a switch on the exterior of the water heater labeled "Electric." This switch must be in the "ON" position for the water heater to work in the electric mode.

Before lighting the water heater, fill the fresh water system. Purge any air from the water heater by opening all hot water faucets until water flows steadily from each one. The water heater installed in this coach is a six gallon gas/electric model with direct spark ignition. This water heater operates on both LP gas and 120 volt electricity. An optional 10 gallon gas/electric model with direct spark ignition may be installed.

It is important to read all of the safety information provided in the water heater manufacturer operation manual in the Owner's Packet. The following instructions are for the standard water heater with direct spark ignition (DSI). This appliance does not have a pilot light. It is equipped with an ignition device that automatically lights the burner. Do not try to light the burner by hand. Before lighting smell all around the appliance area for gas. Be sure to smell next to the floor because some gas is heavier than air and will settle on the floor. Consult the Operation Manual for further instructions if a gas leak is noticed. The gas valve is fully automatic, no adjustments are necessary. Read the safety information provided in the Operation Manual before lighting the appliance. Turn off all of the electrical power to the water heater. Turn the gas supply to the "OFF" position. Wait five minutes for the gas to clear the area. If you smell gas, STOP! Following the safety instructions in the Operations Manual. If gas odor is not noticed, then turn the gas supply to the "ON" position. Turn on the electrical supply to the water heater. Inside the coach there is a switch marked "WATER HEATER." Turn the switch to the "ON" position. There will be a 15 second purge before the unit will spark. If

the burner does not light on the first try, there will automatically be 2 more tries for ignition before it will lock out. Each ignition cycle will have a 15 second purge. If lock out occurs before the main burner lights, turn the switch to "OFF," wait five seconds, and turn the switch to "ON" again. This will re-start the ignition cycle. The initial start-up of the water heater may require several ignition cycles before all of the air is purged from the gas lines.

WARNING
Do not store any combustible materials or liquids near or adjacent to the water heater.

Water Heater Storage

When storing your coach for the winter months, the water heater must be drained to prevent damage from freezing. The first step is to turn off all electrical power and LP gas going to the water heater. The water pump must also be turned off. Open both the hot and cold water faucets to drain the lines. Open the drain on the water heater. Drain the entire water system. When preparing the coach for use after it has been stored, make certain the water system, including the water heater, has been filled before re-lighting the water heater. Failure to fill the water heater before lighting may damage the water heater and void the warranty.

Pressure Relief Valve

The temperature and pressure relief valve is located on the exterior of the water heater. It is designed to open if the temperature of the water within the heater reaches 210° F, or if the water pressure in the heater reaches 150 pounds. Recreational vehicle water systems are closed systems, and during the water heating cycle the pressure build-up in the water system may reach 150 pounds. When this pressure is reached, the pressure relief valve will open and water will drip from the valve. This dripping will continue until the pressure is reduced to below 150 pounds, and the valve closes. This condition is normal and does not indicate a defective relief valve.

WARNING
Do not plug the relief valve under any circumstances.

Notes

CB Radio (Optional)

This coach may be equipped with the optional citizens band (CB) radio. This radio can be used to communicate with other travelers on the road. The model installed is a remote type. The hand held microphone/speaker contains the power, volume, and channel controls. Simply turn on using the power/volume control. Then select the channel you wish to monitor. Press the "Push-to-Talk-Switch" to transmit and release to receive. For more information regarding the operation of this CB radio, please consult the radio manufacturer's owner's manual.

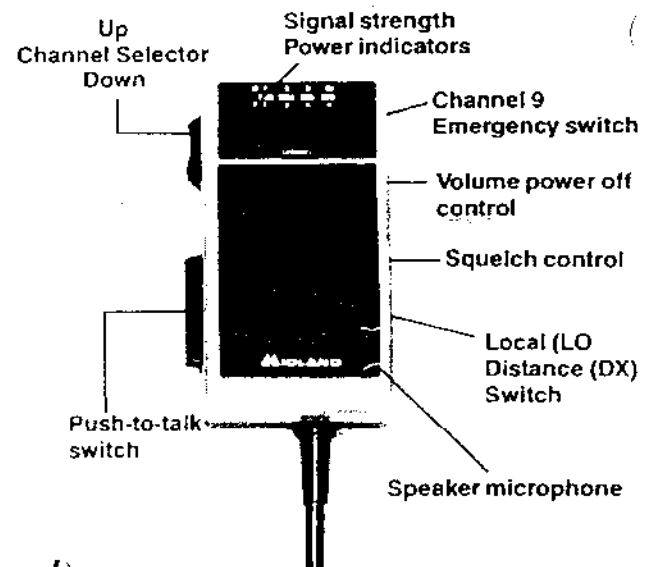

Rear View Monitor System (Optional)

This unit has been pre-wired for the installation of a rear view monitor system. If installed, the rear view monitor system would assist the driver in the backing and parking of the vehicle. This system consists of a camera, mounted on the rear cap, and a monitor, located on the dash. With the MODE switch in the "MANU" position, the monitor will be on when the ignition is turned on. With the MODE Switch in the "AUTO" position, the monitor will display the picture from the camera when the vehicle transmission is placed in reverse (R). For detailed instructions on this and all procedures regarding the monitor system, refer to the monitor operating Instructions in the Owner's Package supplied with this coach.

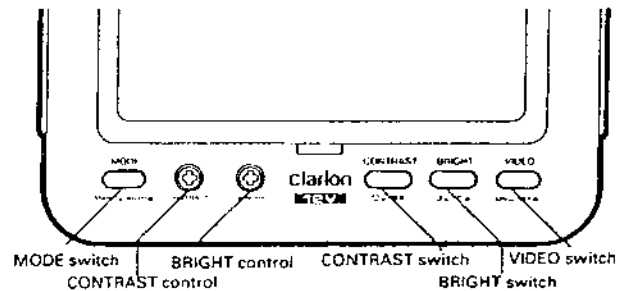

Cellular Antenna (Optional)

The installation of an antenna for use with a cellular telephone is an optional feature on this coach. The antenna would be installed on the roof for optimum transmission and reception with most cellular telephones. The antenna wires terminate under the dash for ease of connection.

Washer/Dryer (Optional)

The plumbing and other preparations for the installation of a washer and dryer are optional on this coach. To have the washer and dryer factory installed is also an option. The washers and dryers used by Newmar function as those in a home, operating on 120 volt electricity. For more detailed information on the operating instructions, read the appliance Owner's Manual in the Owner's Package.

CAUTION

The gray tank valve must be in the "open" position when operating the optional washing machine.

Carbon Monoxide Detector

Carbon monoxide is a colorless, tasteless, odorless gas. It is a by-product of the burning of fossil fuels (gasoline, LP gas, diesel fuel, etc.). The chassis and generator engines, furnaces, water heater, LP gas refrigerator, and range produce carbon monoxide constantly while they are operating. Carbon monoxide is **DEADLY**. Please read and understand the following precautions to protect yourself and others from the effects of carbon monoxide poisoning.

WARNING

Exhaust gases are deadly. Do not block the tailpipes or exhaust ports. Do not situate the vehicle in a place where the exhaust gases have any possibility of accumulating either outside, underneath, or inside your vehicle or any nearby vehicles. Outside air movements can carry exhaust gases inside the vehicle through windows or other openings remote from the exhaust outlet. Operate engines, carbon monoxide-producing systems, or components only when safe dispersion of exhaust gases can be assured. Monitor outside conditions to be sure that exhaust continues to be dispersed safely.

If you, or anyone else, experience any carbon monoxide symptoms (dizziness, nausea, vomiting, muscular twitching, throbbing in the temples, inability to think coherently, weakness and sleepiness, or intense headaches) exit the coach immediately. Seek medical attention if symptoms persist. Shut down the unit and do not operate it until it has been thoroughly inspected and repaired.

WARNING

UNDER NO CIRCUMSTANCE SHOULD YOU OPERATE ANY ENGINE WHILE SLEEPING. When you are sleeping you will not be able to *monitor* outside conditions to assure that engine exhaust does not enter into the coach. Check the exhaust system frequently for damage. If damage is found, do not operate the system. Never modify the exhaust system(s) in any way.

CHAPTER 5

CABINETS & FURNITURE

Table of Contents

Cabinets	5 - 1
Furniture	5 - 2
Living Room Area	5 - 2
Bedroom Area	5 - 2

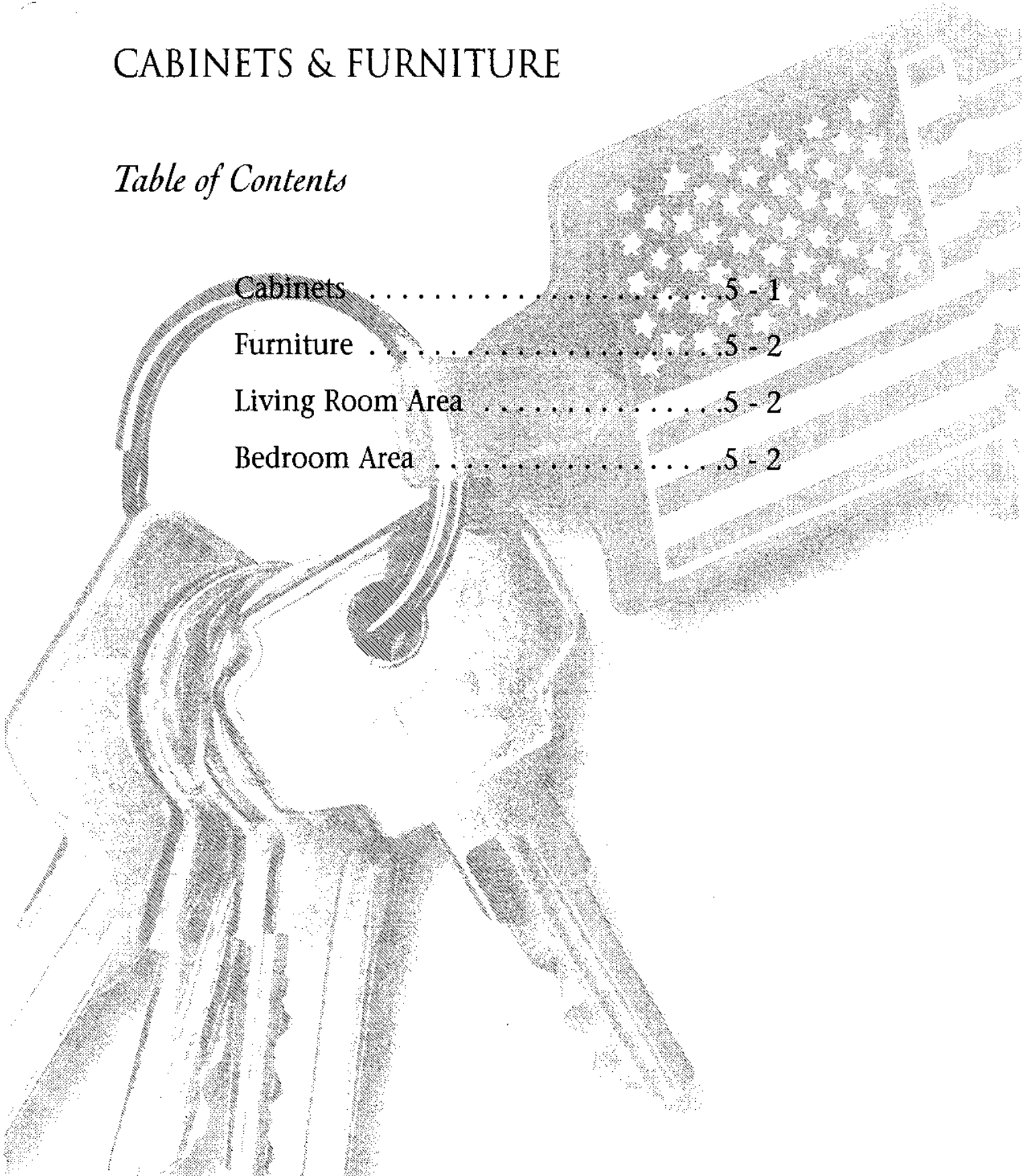

CABINETS

The cabinets in this unit are constructed on site at the Newmar production facility. Oak frame doors with raised panels are standard throughout the unit. The decor option regarding cabinetry is snow maple. These decors have brass door and drawer handles. These give the interior an added touch of class.

Depending upon the floor plan, this unit may be equipped with a counter top extension. If installed, the extension will provide additional counter space while cooking and fold out of the way while entertaining. The silverware drawer contains a molded silverware divider tray for added storage.

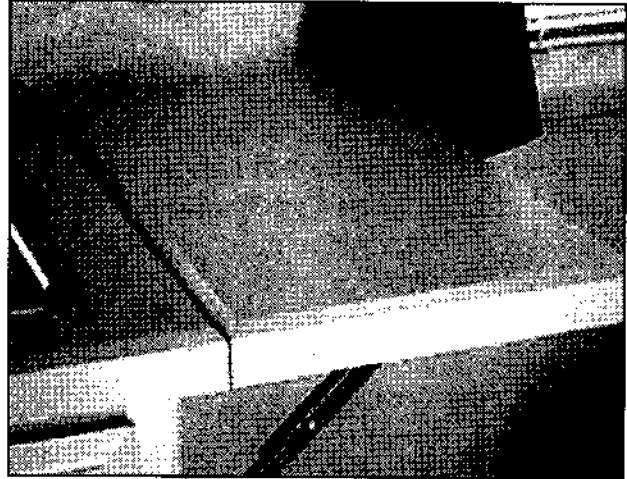

Storage is an important factor to all RV owners. Keeping this in mind, the cabinetry is structured to provide as much storage as possible. An option on most models is the pull out pantry. In the bedroom on all models, the bed platform lifts for convenient storage. This platform is held open by pressurized struts to allow hands-free access.

The counter top in the kitchen and bath is made of a decor matching Corian®. On most floor plans, the “drawer” directly in front of the kitchen and lavatory sink does not pull out, but rather flips down. This provides a storage tray for dish cloths, scouring pads, wash cloths, etc.

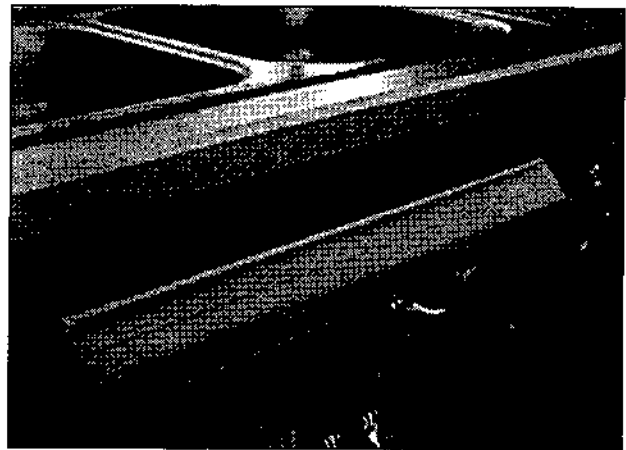

Metal drawer guides are standard on all of the drawers throughout the unit. These guides provide a smooth opening and closing of the drawers. To open a drawer, lift up slightly and pull open. The way this mechanism works will prevent the drawers from unintended opening while traveling. The drawers are constructed with maple panel bottoms for added strength.

All of the wardrobes have lights to assist in storing or retrieving items.

FURNITURE

Living Room/Kitchen Area

A standard feature in the kitchen area is the hidden leaf dinette table. This table allows for more room to be added to the table top when desired. Two fixed chairs and two folding chairs accompany this table. The chair seats and backs are designed with a coordinating upholstery fabric to match your decor.

One popular option in this unit is the built-in dinette booth. The built-in dinette would be installed in place of the free standing table and chairs. The dinette provides added storage under the seat area of the booth, along with an extra sleeping area. The sleeping area is made by lowering the table top and arranging the cushions.

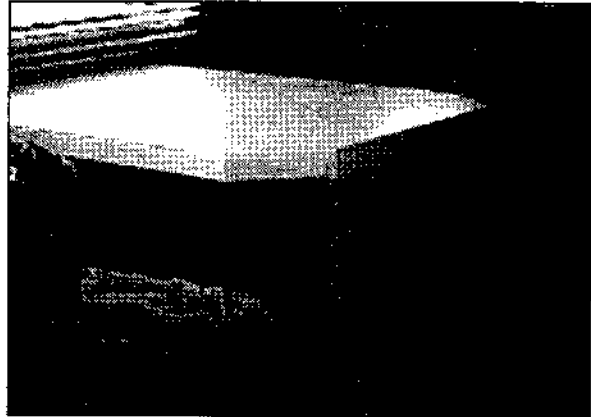

The driver and passenger seats are equipped with three-point seat belts. These should be used whenever the vehicle is in motion. To adjust the driver and passenger chairs for traveling ease, the optional six-way electric powered base will move the chairs forward and backward, as well as up, down, forward and reverse tilt. These chairs also have swivel and recline features. When the unit is not in motion, they can be swiveled to face the living room of the unit. To turn the chairs first, extend the slide out room. Then move the chair backwards all of the way to provide enough clearance for the steering wheel. Once this is done, the chair will swivel without interference. An added feature of this option is the power lumbar support. The control switch is located on the left hand side in front of the power base controls. Pushing the switch forward will inflate the support while pushing back will deflate it.

In the living room of most models, the standard sofa is a Flexsteel Magic Bed Sofa. The sofa is upholstered in decor matching fabric. If you have any questions regarding the warranty on this sofa, contact Flexsteel, the sofa manufacturer. Optional is the Flexsteel Hide-A-Bed sofa.

The standard living room chair is the Flexsteel recliner. In place of this standard chair, a Flexsteel leather/vinyl, swivel/rocker recliner may be optioned.

Bedroom Area

As previously stated, the bed platform lifts for added storage. The decor coordinating quilted bedspread with reverse sham and an accent pillow is included as part of this unit's standard package. On each side of the bed you will find wardrobe closets and drawers.

CHAPTER 6

STRUCTURE FEATURES

Table of Contents

Structure Features	6 - 1
Alignment	6 - 1

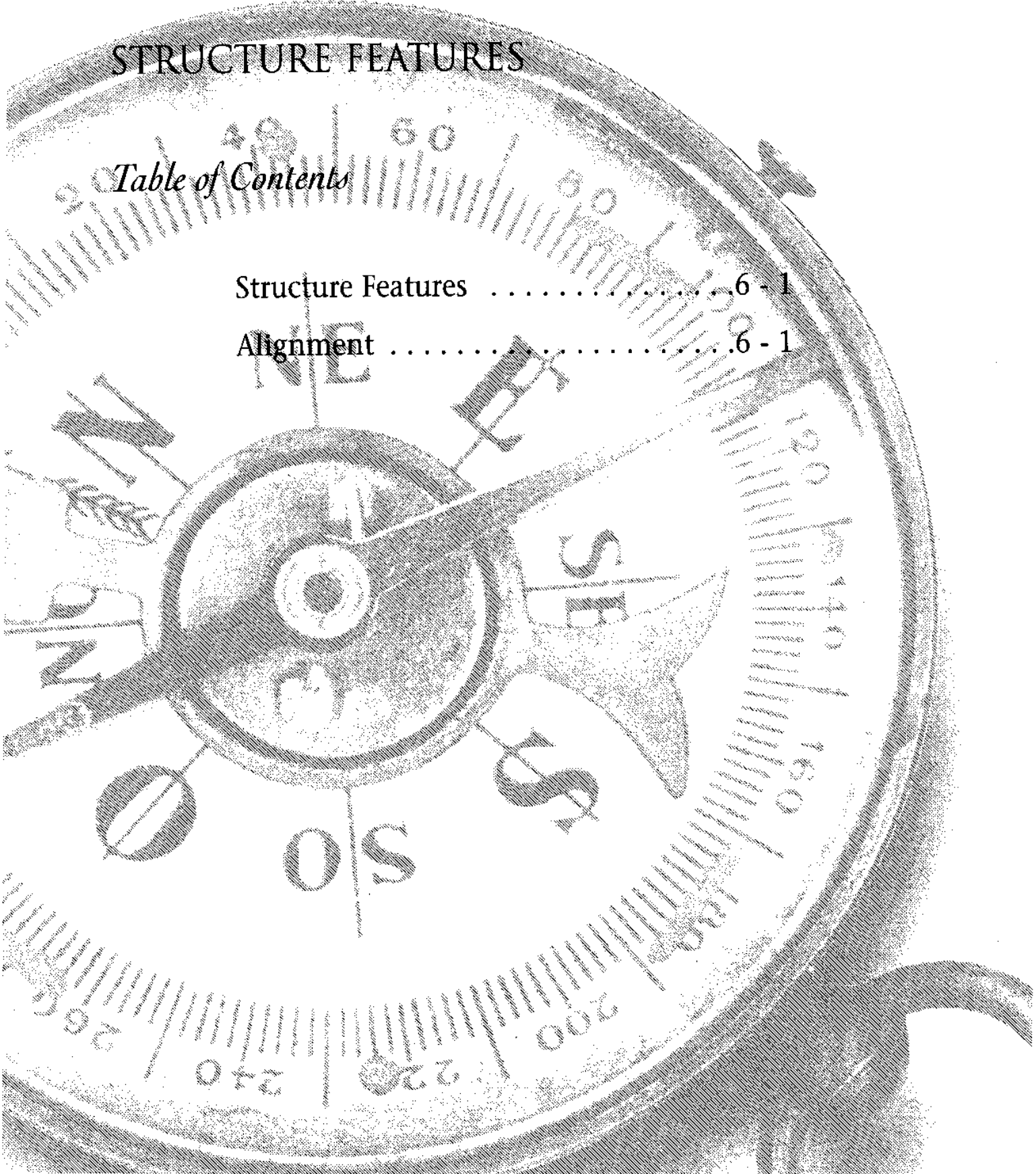

CHAPTER 7

ELECTRICAL FEATURES

Table of Contents

General Information	7 - 1
Breaker Boxes	7 - 1
Electrical Diagrams	7 - 1
Batteries	7 - 2
Battery Boost Switch	7 - 2
Battery Inspection & Care	7 - 2
Battery Disconnect Panel	7 - 3
12 Volt Receptacles	7 - 4
120 Volt Receptacles	7 - 4
GFCI Receptacles	7 - 4
ICC Flasher	7 - 4
Generator Prep	7 - 5
Wiring Connector	7 - 5
Resettable Breakers	7 - 6

ELECTRICAL SYSTEMS

General Information

There are two electrical systems in your coach. They are the 12 volt DC system and the 120 AC volt system. Most standard appliances require the 120 volt system while the majority of the lighting used in recreation vehicles is powered by 12 volt. The power for the 12 volt system is supplied by the coach batteries, which are charged by the 55 amp power converter. The power for the 120 volt systems is supplied by the power cord when the unit is connected to an outside power source or by the generator.

CAUTION

Failure to turn off the 120 volt appliances when starting or stopping the generator may damage the transfer switch and/or electrical appliances.

To connect the unit to 120 volt shore power, first make sure all of the breakers are in the off position. This is done to avoid a power surge. Unwind the power cord from the electrical compartment. The standard electrical service in this unit is 50 amp with a flexible cord. Check to make sure the pins in the outlet are oriented correctly, that they match the power cable, and that they are in good condition. If there is a circuit breaker switch at the plug, it should be turned OFF before making the connection. Insert the plug completely into the outlet and turn the circuit breaker on. Close and lock the electrical compartment door to keep the contents clean, dry, and secure. Close the cover on the power box, if equipped, to avoid an unintended disconnection and to keep contents clean. Switch the main breaker to the ON position. The 120 volt system will energize all 120 volt circuits and outlets when the main breaker is turned on.

Breaker Boxes

The 120 volt and 12 volt breaker boxes are generally located in the overhead cabinet on the rear bedroom wall. Circuit breakers and fuses are installed to protect the electrical system from overloading. Do not attempt to change the circuitry or add appliances yourself. Please consult an authorized Newmar Service Center.

Electrical Diagrams

In Chapter 15, you will find typical 12 volt and 120 volt electrical diagrams.

Notes

Batteries

The chassis batteries on your motorhome are installed and warranted by the chassis manufacturer. The two 12 volt coach (or house) batteries on your motorhome are installed by Newmar Corporation, but warranted by the battery manufacturer. These batteries are used to operate the 12 volt items that are not a direct part of the chassis. They are located on a pull out drawer in an outside compartment.

CAUTION

Do not use the motorhome with the coach batteries disconnected.

The coach and chassis batteries are recharged by the vehicle's electrical system whenever the engine is running. A decline in the coach battery voltage may be noticed while the chassis batteries are being charged. The converter will automatically charge the coach batteries when the unit is connected to a 120 volt outside power source. The chassis batteries are isolated from the coach batteries. This prevents the chassis batteries from being drained by the interior 12 volt equipment, allowing ample voltage for engine ignition.

Battery Boost Switch

The battery boost switch is located on the dash. This switch briefly connects the coach batteries to the chassis batteries. This allows the chassis batteries to borrow power from the coach batteries to assist in starting the engine. If the chassis batteries cannot turn the engine over in the normal mode, hold down the battery boost switch and attempt ignition. By using the battery boost switch while trying to start the chassis engine, a jump start situation is created between the coach and chassis batteries. If the battery boost switch is required to start the engine on a regular basis, ask your dealer to check the chassis batteries and charging system.

Battery Inspection & Care

WARNING

Remove rings, metal watch bands, and other metal jewelry before working around batteries. Use caution when using metal tools. If a tool contacts a battery terminal or metal connected to it, a short circuit could occur which could cause personal injury, explosion or fire.

CAUTION

Disconnect the 120 volt electrical power cord and the negative terminal from the coach batteries before working on the electrical system.

Remember that when batteries are not used for an extended period of time, they may lose their charge. Periodic charging of the batteries during storage of the unit will increase the life of the battery. Check the external condition of the battery periodically. Look for cracks in the cover and case. Check the vent plugs and replace them if they are cracked or broken. Keep

the battery clean. Accumulations of acid film and dirt may permit current flow between the terminals, which could drain the battery.

To clean, wash the batteries with a diluted solution of baking soda and water to neutralize any acid present. Rinse thoroughly with clean water. Foaming around the terminals or on top of the battery is a sign that acid is being neutralized. Avoid getting the baking soda solution in the battery. Secure all vent caps. Dry the battery cables and terminals to prevent corrosion. Do not use grease on the bare metal inside the cable terminals. Grease can act as an insulator, and electricity will not flow through it. A plastic ignition spray will protect the terminals after they have been cleaned.

WARNING

Do not allow the battery fluid to contact your skin, eyes, fabric, or painted surfaces. The fluid could cause serious personal injury or property damage. Wear eye protection when working with any battery.

The batteries should be removed and stored in a warm place when not using your motorhome for an extended period of time. Mark the cables, positive and negative, for easy identification. Batteries are not to be stored on concrete floors. The batteries require periodic charging during storage. If the motorhome is to be stored for a long period of time, it is recommended that all of the batteries inside the unit be removed from clocks, radios, smoke alarms, etc. This will prevent unnecessary drain and corrosion of the batteries. The coach batteries are 6 volt RV/Marine deep cycle batteries. This type of battery consumes water and must be filled periodically. Consult the owner's manual supplied by the battery manufacturer. This can be found in the Owner Information Package received with this unit.

Battery Disconnect Panel

The battery disconnect panel is located above or near the entrance door. There are two switches on the panel. The top switch is used to measure the battery voltage. The lower switch is used to disconnect the battery when the unit is stored for any period of time. Pressing downward disconnects the coach batteries, not the chassis batteries. This is done to prevent the coach batteries from being drained during storage. It disconnects all of the 12 volt circuitry from the batteries, with the exception of the CO and LP detectors. For information regarding the disconnection of

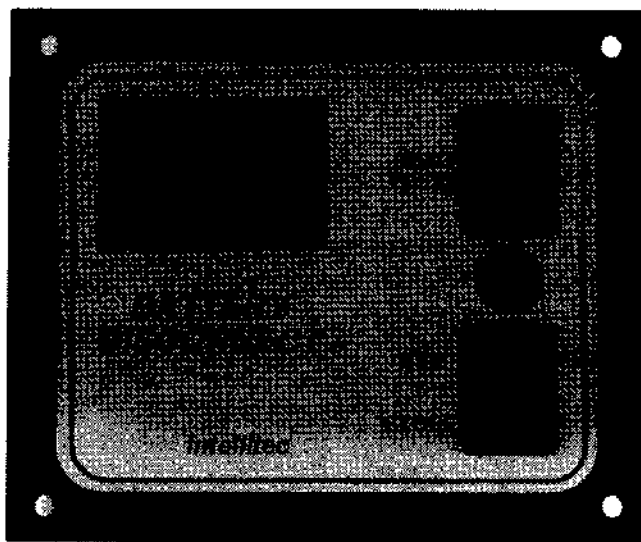

the power to the two detectors, see DETECTORS. When taking the unit out of storage, press upward to re-connect the batteries. This will make the 12 volt system ready for use. Diesel pusher motor homes are equipped with a second disconnect switch strictly for the chassis batteries. This "Master Kill Switch" is located in the rear engine compartment. It is used to prevent accidental ignition when the engine is being serviced.

12 Volt Receptacles

Your unit is equipped with several 12 volt receptacles conveniently located in the dash area. One is located on each of the ashtrays beside the driver's or passenger's chair. There are also two other receptacles located on the dash. These 12 volt receptacles can be used for items such as cellular phones or personal computers.

120 Volt Receptacles

For your convenience, there are 120 volt receptacles located throughout the interior of the unit. These receptacles require three-pin plugs that provide proper grounding to protect you from electrical shock. Do not use an adapter, cheater, or extension cord that breaks the continuity of the ground circuit to the ground pin. Never remove the ground pin from a plug in order to connect it to a two-pronged ungrounded outlet. Never operate the camping vehicle with an electrical short. An electrical short may cause the exterior of the unit to shock you when touched. If you feel even the slightest shock, disconnect the unit from the 120 volt power source and locate the fault. It is usually a break in the grounding circuit. The grounding circuit must be continuous from the frame to the distribution panel, to the power cord, and to the earth ground.

Ground Fault Circuit Interrupt Receptacles

The 120 volt electrical outlets in the kitchen and bath area are ground fault circuit interrupt (GFCI) receptacles. The GFCI outlets provide an overload and short circuit protection. The electrical outlets located in the slide out are wired through the kitchen GFCI. The exterior electrical outlets are wired through the bathroom GFCI. If an item plugged into a slide out or outside receptacle is not working, check for a tripped GFCI in the kitchen or bathroom. In addition, these outlets protect the user from ground faults between a hot wire and ground. The GFCI will not reduce the shock hazard if the short is between a neutral and hot wire, or two hot load wires.

The GFCI should be tested at least once a month. The 120 volt electrical system must be on in order to test the GFCI. The reset button needs to be pushed in all of the way before starting the test. Push the test button. This will cause the reset button to pop out which means that the protected circuits have been disconnected. Push the reset button back in until a click is heard. This will reactivate the protected circuit. If the GFCI is working properly, the reset button will remain in the "IN" position.

ICC Flasher

On the dash, you will find a switch labeled "ICC Flasher." This switch is a momentary type of switch. This means it is only active while the switch is being pressed. It enables the driver to communicate with other traffic by flashing the clearance and side lights of the coach. If the lights are on it will, turn them off. If the lights are off, it will turn them on.

Generator Prep

A standard feature on this unit is the preparation for the installation of a generator. If the generator is installed, it is generally located in an exterior compartment behind the rear axle of the motor home. It is mounted on slides for easy removal. The slides for the generator must be unlocked before free movement is allowed. Prior to starting or stopping the generator, make sure all of the 120 volt appliances are turned off. The generator can be started from either the remote start switch located on the dash or directly at the generator itself. The hour meter installed on the generator calculates the number of running hours of the generator motor. This is used for maintenance schedules.

CAUTION

Failure to turn off the 120 volt appliances when starting or stopping the generator may damage the electrical appliances.

Consult the manufacturer owner's manual for detailed operating instructions.

Wiring Connector

Standard on all Newmar motorhomes is the car towing hitch. This allows the consumer the capability of towing their passenger car while traveling. Also installed with the hitch is the wiring pigtail to connect tail lights, brake lights, turn lights, etc. of the towed vehicle with that of the motor home. The pigtail used is the standard seven-pin connector. The color scheme for the pigtail is as follows:

- | | | |
|--|---------------------------------------|-----------------------|
| Stop & Left Turn SignalRed | Stop & Right Turn SignalBrown | GroundWhite |
| Clearance & Tail LightsGreen | BrakesBlue | |
| Aux. Tow Connector PrepBlack | Back-up LightsYellow | |

Below is the diagram of both the trailer and motor home side of the pigtail. As stated above, this is a standard seven-pin pigtail.

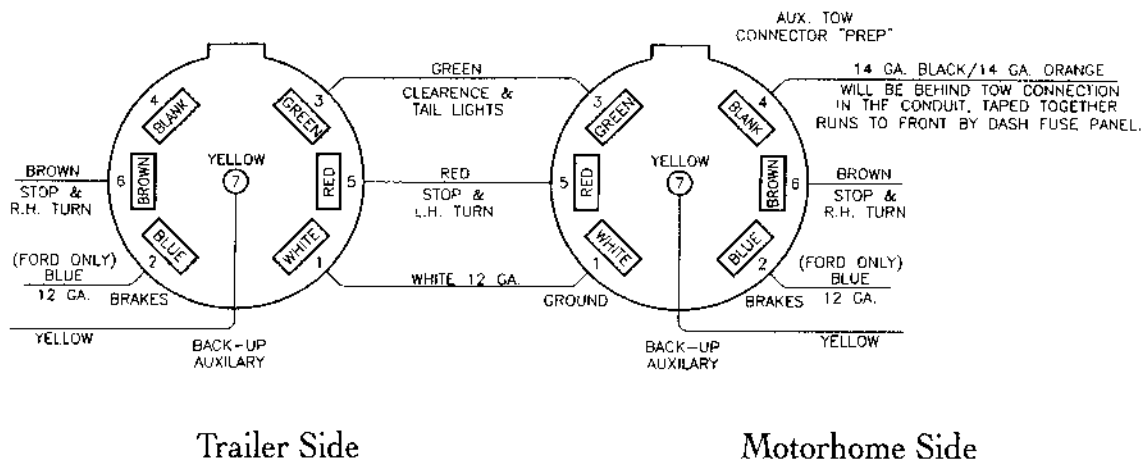

RESETTABLE BREAKERS

The resettable breakers are located within 18 inches of the source of power. This is the converter and the battery. (Figure 1)

When either of the breakers are shut down they must be manually reset.

To find the breakers, follow the line from the battery or converter approximately 18 inches.

This may lead to a junction box or to a cabinet inside the unit or similar location.

Manually reset the breaker as shown at right in Figure 2.

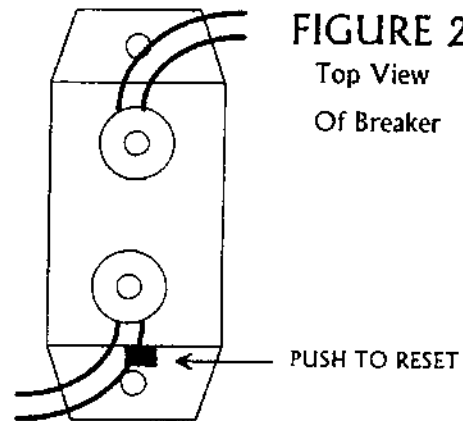

FIGURE 2
Top View
Of Breaker

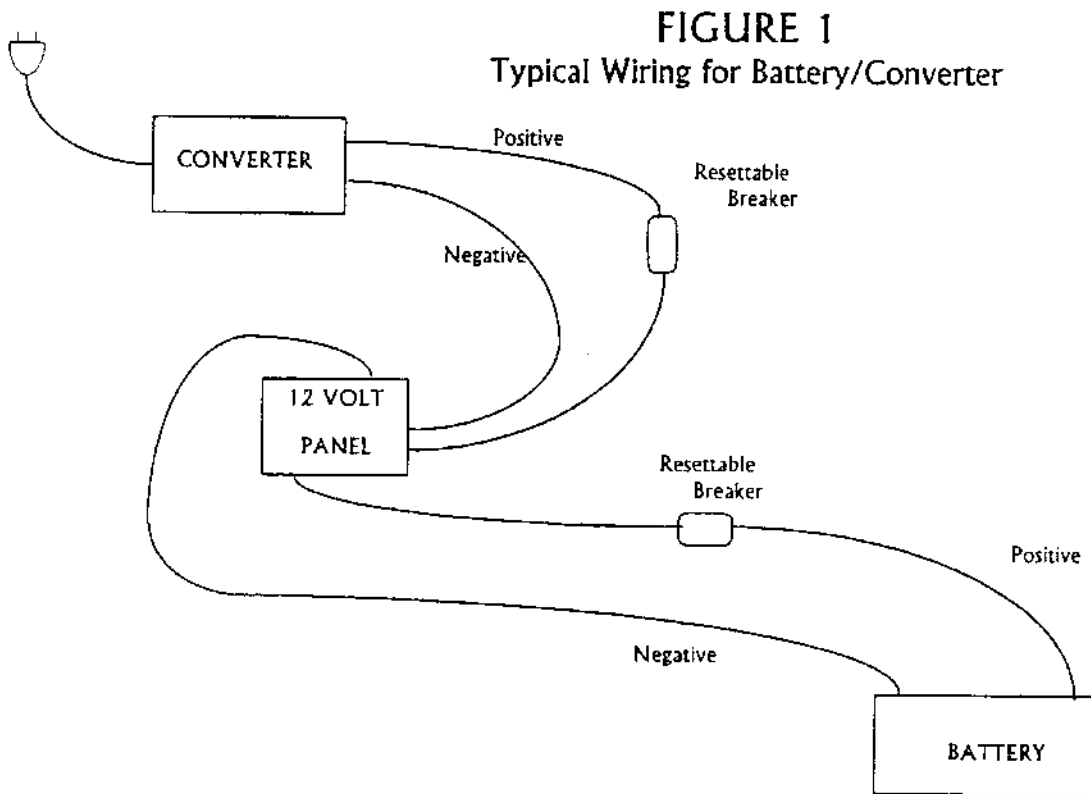

FIGURE 1
Typical Wiring for Battery/Converter

CHAPTER 8

SLIDE OUT FEATURES

Table of Contents

General Instructions	8 - 1
Extending	8 - 2
Retracting	8 - 2
Manual Operation	8 - 2
Operating Precautions	8 - 3

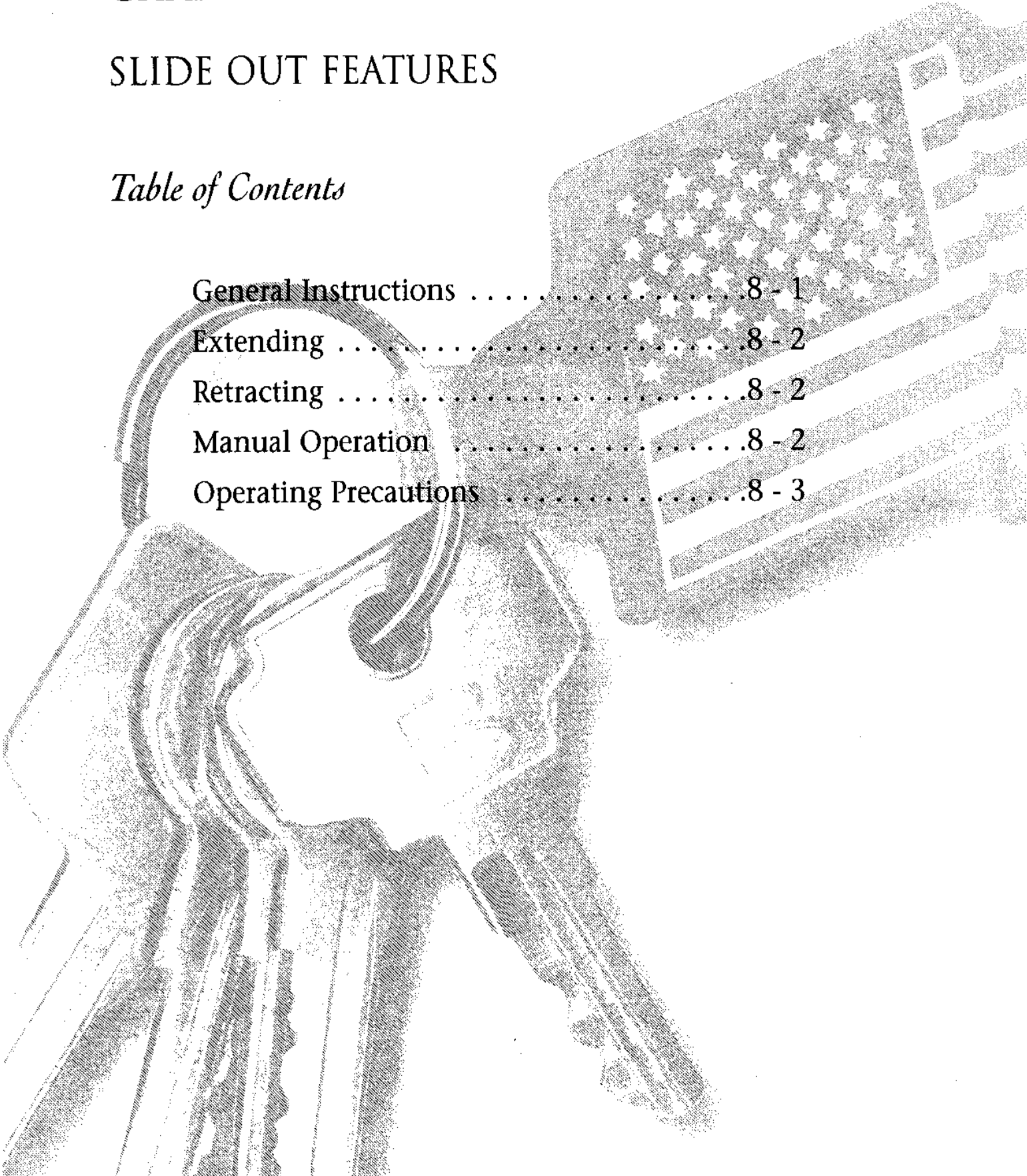

WARNING

READ THE FOLLOWING SLIDE OUT ROOM INSTRUCTIONS BEFORE ACTIVATING THE SWITCH.

CAUTION

The leveling jacks must be extended and the unit level before operating the slide out.

GENERAL INSTRUCTIONS

IMPORTANT

The slide out room should be inspected for alignment every six (6) months. If alignment is necessary, have the room adjusted.

1. The slide out room can be stopped at any time by activating the slide out switch. The room will reverse directions each time the switch is activated.
2. If the slide out room stops before reaching the full "OUT" or "IN" position, the slide out controller may need adjustment.
3. To adjust the slide out controller, turn the adjustment screw clockwise to increase the power and counter-clockwise to decrease the power.

CAUTION

Move the adjustment screw in small increments. Try moving the slide out room again. Use caution. There is a potential for component or structural damage if the screw is adjusted too high.

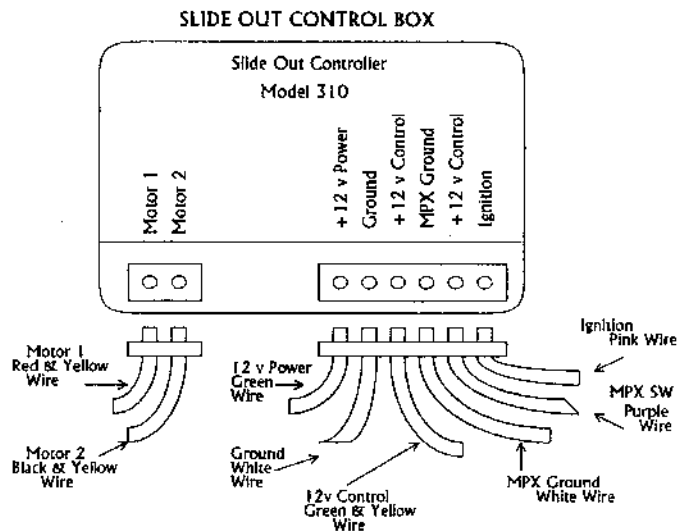

IMPORTANT

This screw does not adjust the slide out room speed. It sets the amount of power required to move the room against the mechanical stops.

Extending the Slide Out Room

1. The windows on the end of the slide out room must be closed before moving the room in either direction.
2. Before extending or retracting the room, look for and remove any obstructions.
3. Move the driver's chair forward before moving the slide out room in either direction.
4. Disengage the lock arms by pulling down on the center of the arm using the lock arm release tool, as required.
5. Activate the slide out switch. Once fully extended, the room will automatically stop. The indicator light will be lit while the room is traveling.

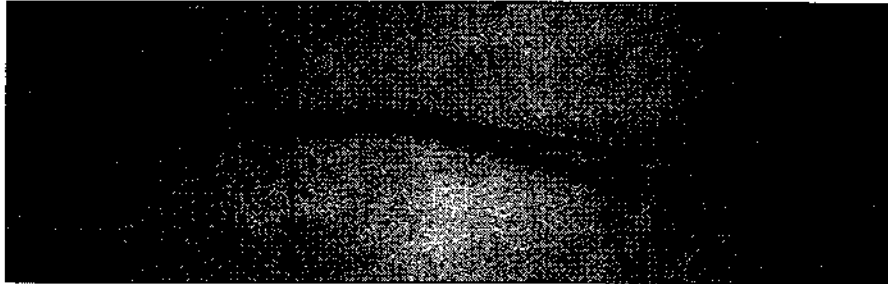

Retracting the Slide Out Room

1. Activate the slide out switch. When fully retracted, the room will automatically stop. The indicator light will be lit while the room is traveling.
2. Before moving the coach, engage the lock arms by pushing the arm up into the locked position using the lock arm tool, as required.

Manual Extension & Retraction

SHAFT END-MOUNTED MOTORS

If the motor is mounted on the ends of the slide out shaft, use the following directions:

1. Access must be gained to the TRANS-TORQUE bushing coupling at the end of the slide out gear motor.
2. Using a ½" drive – 1½" open end wrench and a ½" drive ratchet wrench, loosen the 1½" nut. This will require approximately 1½ turns. The nut is a standard right hand thread. After the initial release, the nut will turn for a partial turn, then will release again as you turn the wrench. This second release is required to loosen the TRANS-TORQUE bushing from the shaft.

SHAFT CENTER-MOUNTED MOTORS

If the unit is equipped with the K-900 slide out motor which is mounted near the center of the slide out room, use the following directions:

1. Access must be gained to the slide out motor located in the center of the slide out room.
2. The manual extension or retraction requires only a $\frac{5}{8}$ " socket and ratchet wrench. By placing the socket on the $\frac{5}{8}$ " hex nut located on the gear box of the K-900 motor, the slide out can be moved in either direction by turning the hex nut.
3. If the slide out does not move by using the hex nut, the room can also be extended or retracted by using the procedure described for the SHAFT END-MOUNTED MOTORS. If the room is moved using this method, the correct torque on the $1\frac{1}{2}$ " TRANS-TORQUE nut is 125 foot pounds MAXIMUM.

Slide outs with either the center-mounted or end-mounted motors can be moved by pushing the room the full length of its travel in either direction. This method will require the assistance of at least two people.

IMPORTANT

The TRANS-TORQUE bushing must be re-tightened to re-couple the slide out gear motor before moving the coach. This will hold the slide out room in place. The correct torque on the $1\frac{1}{2}$ " TRANS-TORQUE bushing is 110 foot pounds maximum. The correct torque on the $1\frac{1}{2}$ " TRANS-TORQUE bushing of the K-900 motor (center shaft motor) is 125 foot pounds maximum.

Operating Precautions

WARNING

Before extending the slide out, make certain that there is a minimum of five (5) feet of clear space on the slide out side of the unit. Prior to extending the room, be sure to unlock the slide out locking arms.

Before extending the slide out, make sure that the unit is level and that the stabilizing jacks, if available, have been set. Make sure there are no obstructions either inside or outside the unit that may interfere with the slide out extension. Tree branches, bushes, or telephone poles can cause extensive damage to the exterior of the unit.

Notes

CHAPTER 9

EXTERIOR FEATURES

Table of Contents

Hitch	9 - 1
Exterior Sides	9 - 1
Security Lights	9 - 1
Roof	9 - 1
Jacks	9 - 1
Jacks with Touch Control	9 - 2
Electric Steps	9 - 3
Mirrors	9 - 4

EXTERIOR FEATURES

Hitch

On the rear of this unit you will find a Class 2, 5,000 pound car towing hitch. This is installed for towing passenger cars to be used when the vehicle is parked. The wire connector installed with this hitch is a standard seven-pin connector. For more information on the connector, please see Chapter 7 of this guide.

Exterior Sides

The sides of this unit are constructed of gel-coated fiberglass. To add to this feature, the rear end caps are gel-coated fiberglass. Clean the fiberglass material with a mild cleanser and warm water. Use only soft cloths. Using stiff bristle brushes may cause scratches in the fiberglass surface.

Security Lights

Standard on this unit are exterior security lights. One is located on each side of the coach. As an option, two may be installed on each side of the coach.

Roof

The standard unit is manufactured with a rubber roof. On this model, the roof rack and ladder are standard features.

Jacks (Optional)

WARNING

If the vehicle is equipped with a slide out, do NOT operate any room extension until the leveling and stabilizing procedure is complete. Do NOT retract the leveling system until the slide out room has been retracted. NEVER operate the leveling system when the slide out is extended.

This unit may be equipped with hydraulic leveling jacks. Optional are the touch control jacks. The jacks work in pairs: front, right side, left side, and rear. Before extending, the engine must be off, the ignition switch must be in the "ACC" position, and the transmission must be in park. The parking brake needs to be set and the tires blocked securely.

CAUTION

Do not lift the wheels off the ground when leveling. The unit can roll forward or backward when supported only by the jacks.

IMPORTANT

If the hand/auto park brake is not set, the "NOT IN PARK/BRAKE" light will come on when the "ON" button is pushed. The panel will turn on, but the system will not operate.

Touch Manual Control Pad (Optional)

To extend, press the "ON" button on the HWH control panel. The "POWER ON" light will illuminate. Place pads under the jacks, if necessary, at this time. A lit yellow "LEVEL" light indicates that the end, side, or corner is low. Push an "EXTEND" (up arrow) button to extend the jack pairs according to the lit yellow lights. Always level the vehicle from side to side before leveling the vehicle from front to rear. Two yellow "LEVEL" lights can be on at one time. Extend the jack pair accordingly until all yellow lights are out. If the ground is too uneven, the jacks may not have enough stroke to level the vehicle. The vehicle may have to be moved. After the vehicle is level, the jacks not used for leveling may be extended until they touch the ground. This provides additional stability against wind and activity in the vehicle. Do this by pushing the front and/or rear "EXTEND" buttons as needed to extend any remaining jacks. Do not use the right or left "EXTEND" button. Push the "OFF" button on the touch panel. Turn the ignition switch off.

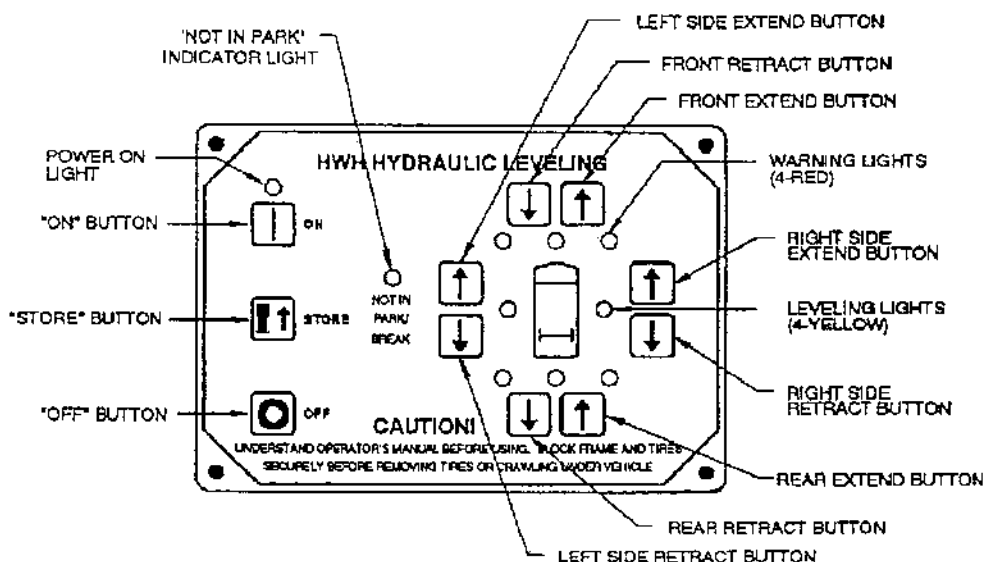

IMPORTANT

The leveling system should be cycled once a month or whenever the vehicle is used to keep the system in operating condition.

To retract the jacks, turn the ignition switch "ON" and press the "ON" button on the control panel one time. The "ON" indicator light will glow steady. Press the "STORE" button. As each jack retracts, its red "WARNING" light will go out. The vehicle can be moved as soon as the red "WARNING" lights are out, provided the jacks are in the STORE/TRAVEL position. The system will automatically shut down approximately two minutes after the four

individual red "WARNING" lights are out. Refer to the HWH Owner's Manual for more instructions.

Electric Steps

This unit is equipped with electric double entrance door steps. When the power switch for the steps is in the on position, simply open the door and the steps will open. Detailed operation for the electrical entrance door steps is as follows:

1. Turn the step power switch on.
2. Close the door. The step should retract and lock into the up position.
3. Open the door. The step should extend and lock into the down position.
4. Turn the step power switch off. The step should remain in the extended position when the door is closed. Turning off the power with the step retracted will hold the step in a retracted position as well.
5. With the step extended, turn the step power switch off and close the entrance door. Turn the vehicle ignition on. The ignition override system will go into effect, and the step will automatically retract.

CAUTION

If the vehicle is driven with the step in the extended position, there is the possibility of causing major damage to both the step and the vehicle.

6. Turn the vehicle ignition off and open the door. The step will extend and lock in the down position.

CAUTION

If the door is opened and closed without allowing the step to fully extend and lock in the 'DOWN' position, the step will retract and lock in the 'UP' position. When the door is reopened, the step will not extend. The power switch must be turned on for the step to extend.

7. This feature is only operative the first time that door is opened after the vehicle ignition is turned off. When the ignition is on, the step will always activate with the door movement, regardless of the step power switch position.

Notes

MIRRORS

This vehicle is equipped with exterior convex remote controlled rear view mirrors with defrost features. Always adjust the mirrors for maximum rear visibility prior to driving. Make sure the seat is positioned for proper vehicle control.

These mirrors are adjusted by using the multiple directional switch located on the driver's door. Select the mirror to be adjusted by pointing the arrow in the direction of that mirror. Move the control in the direction of movement desired to obtain the best view. The adjustment control moves the top half of both mirrors. The bottom half of the mirror is convex and is adjusted manually. These mirrors also contain heating elements to defog or de-ice the mirror glass during cold weather operation. The ON/OFF switch for this feature is located by the adjustment control.

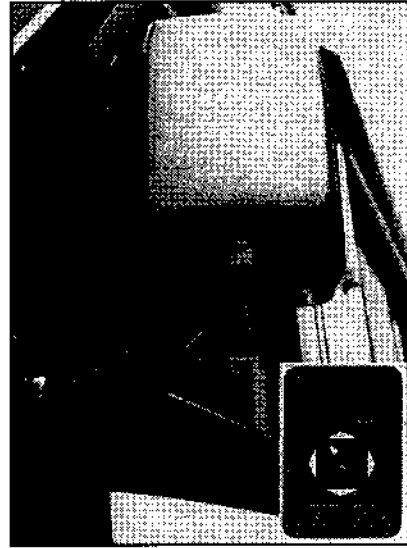

IMPORTANT

Objects viewed in convex mirrors appear smaller and farther away than they actually are.

Notes

CHAPTER 10

INTERIOR FEATURES

Table of Contents

Bedspread	10 - 1
Flooring	10 - 1
Ceiling	10 - 1
Window Treatment	10 - 1

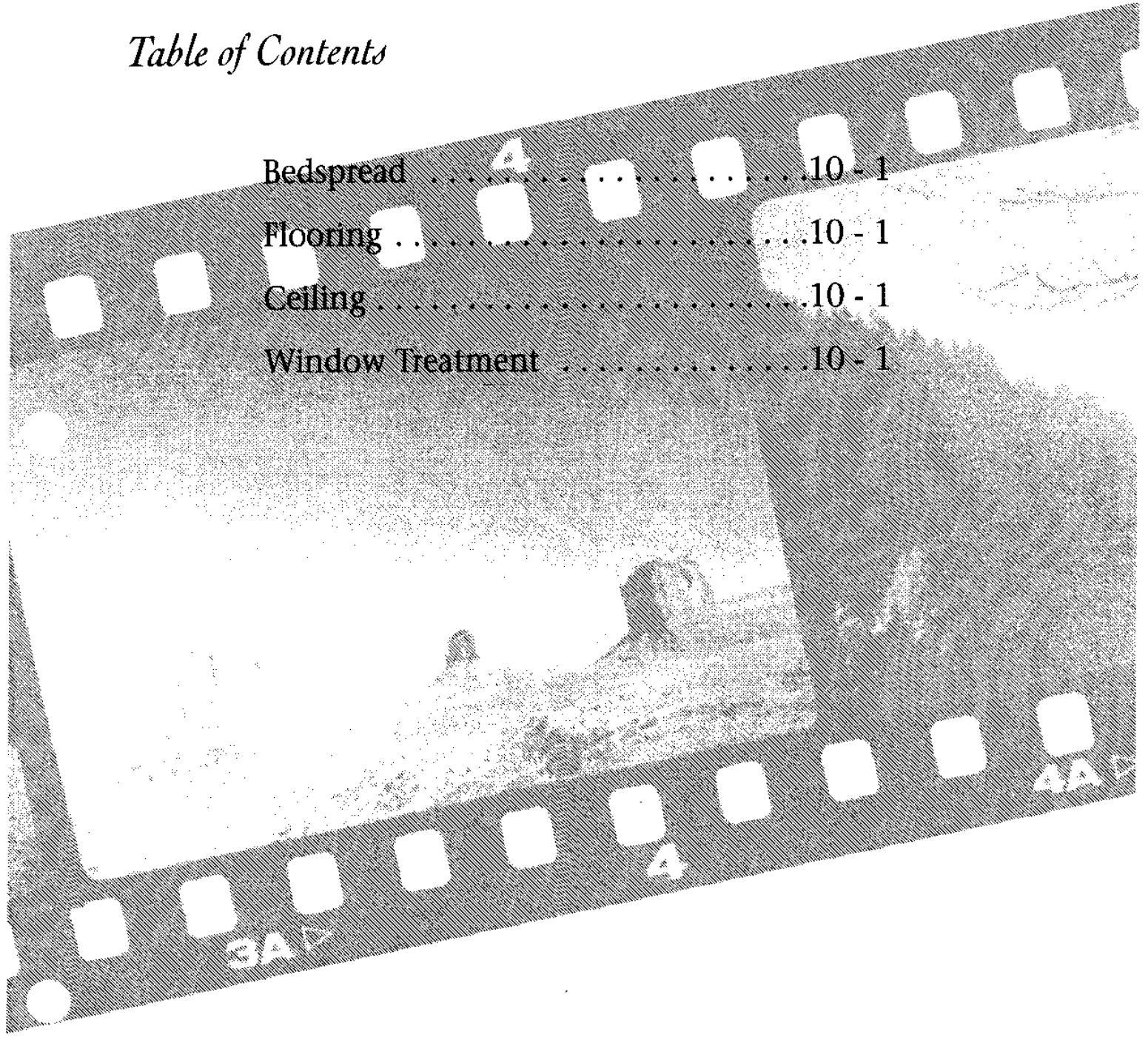

INTERIOR FEATURES

Bedsread

All units have a decor matching fitted bedsread enclosed as part of the standard package. The recommended cleaning instructions for this spread are Dry Clean Only. The materials that make up the spread may have been treated, and dry cleaning will preserve this treatment.

Flooring

The floor covering for the living room and bedroom of the unit is carpet. In the Owner's Information Package you will find literature supplied by the carpet manufacturer. This information will be helpful in maintaining and extending the life of the carpet. Please refer to this information for the carpet care and cleaning instructions. The standard floor covering in the kitchen and bath area is a vinyl linoleum. The cleaning procedures for this flooring are the same as with any linoleum. Use a mild soap with warm water and a soft cloth or mop. The optional floor covering available in the kitchen and bath would be the simulated plank. Also optional in the bath area is ceramic floor tile. For everyday cleaning mop occasionally, using a minimal amount of water. For more thorough cleaning, mop with a mixture of soap-free household cleaner and water (vinegar and ammonia both work well). Be careful not to saturate the floor with water; this could damage the flooring. Abrasive cleansers and scouring pads can scratch and damage the surface also.

Ceiling

The ceiling in this unit is covered with a padded vinyl. The recommended cleaning instructions would be a soft cloth and mild detergent.

Window Treatment

The window treatment throughout this unit, except in the kitchen, is pleated day/night soft shades and lambrequins. These shades have two sections. The first section visible when closing the shade is the "DAY" section. This material is translucent. Sunlight passes easily through the material into the unit. The second visible section is the "NIGHT" section. This material is a heavier, more opaque material. Very little to no light passes through it. It is generally used in the evening or when more privacy is desired. The kitchen window is equipped with a mini-blind. Sun shades are optional on the side windows.

Notes

CHAPTER 11

PLUMBING & BATH FEATURES

Table of Contents

Kitchen Sink	11 - 1
Bath Sink, Shower & Accessories	11 - 1
Monitor Panel	11 - 1
Monitor Panel Calibration	11 - 1
Water Pump	11 - 2
City Water Hook-Up	11 - 3
Fresh Water Tank Fill	11 - 3
Sanitizing	11 - 4
Drink Dispenser with Water Filter	11 - 5
Water Heater By-Pass	11 - 5
Fresh Water Lines	11 - 5
Waste Water System	11 - 6
Toilet	11 - 6
P-Traps	11 - 6
Black Water Holding Tank	11 - 6
Gray Water Holding Tank	11 - 7
Waste Water Disposal	11 - 7
Camping with Sewer Hook-Up	11 - 8
No Fuss Flush	11 - 8

FRESH WATER SYSTEM

Kitchen Sink

The kitchen sink installed is a double bowl Brite Star sink. The unit has two sink covers to provide additional counter space when the sink is not in use. Cleaning care consists of washing with mild detergents and a soft cloth. Avoid using "S.O.S." type cleaning pads because they may scratch the surface. The faucet in the kitchen is an 8" chrome single-handle faucet with lavatory spray.

Bath Sink, Shower & Accessories

The sink in the bathroom is vacuum formed durable white plastic. Use care when cleaning to prevent scratching the surface. The bathroom accessories include two towel bars, a robe hook and a tissue holder. The faucet in the bathroom is a decor matching white duel-handle faucet. The shower installed is a combination fiberglass tub and shower surround with enclosure. The white tub faucet with shower head, hose, and bracket are decor coordinates with the sink faucet.

Monitor Panel

The monitor panel allows you to check the approximate levels in the fresh, gray, and black water holding tanks, as well as the battery condition. The monitor panel is generally located above or near the entrance door. Simply press the button of the item to check its status. The empty indicator light will always light when the button is pressed. If the tank is full, all of the lights will be on. Lights are sequential and indicate the level in approximately $\frac{1}{4}$ tank increments. For example: If the tank selected is approximately $\frac{1}{2}$ -full, then the indicator lights E , $\frac{1}{4}$, and $\frac{1}{2}$ will be lit. On the right hand side of the monitor panel is the water pump switch. This switch controls the power going to the water pump, turning it either on or off.

Monitor Panel Calibration

The monitor panel comes to you factory calibrated for accuracy and should not need to be adjusted. In the event that the system does not read accurately, then re-calibration may be necessary. The procedure for re-calibration is simple: First, fill the tank to be re-calibrated. Second, using the adjustment tool enclosed in the Owner's Package (or any small flat-bladed screw driver), simultaneously push the button for that tank and rotate the adjustment screw located above the button and behind the face plate counter-clockwise until some of the lights turn off in sequence. Then slowly rotate the adjustment screw clockwise until the full light is completely on. Repeat this procedure as necessary for the remaining tanks. The system is now calibrated properly.

Water Pump

The water pump is self-priming and totally automatic, operating on demand whenever water is required. The water pump is used to pressurize the fresh water system when the unit is not connected to city water. The water pump switches are located in the bathroom above the entrance door and in the water works compartment. To start the pump follow these instructions:

1. Fill or partially fill the fresh water supply tank.
2. Open the kitchen and bathroom faucets.
3. Turn the water pump switch on and allow the water to fill the water line and the hot water heater.
4. Close each faucet after it delivers a steady stream of water (close the cold water first). Leave the hot water faucets on until they also deliver a steady stream of water. This will ensure that the water heater is filled with water.
5. The water pump should stop running once all faucets are closed.
6. The pump is now ready for automatic operation. The pump will run when a faucet is opened and stop when a faucet is closed.
7. Never allow the pump to run for long periods of time without water in the supply tank. Pump damage or blown fuses may result.

If water doesn't flow when a faucet is turned on while using the demand system, use the following trouble shooting chart:

SITUATION	SOLUTION
Pump running - no water	<ol style="list-style-type: none">1. Fill tank2. Clear the water line to the pump3. Check the fresh water fill valve position
Pump doesn't run	<ol style="list-style-type: none">1. Check the pump switch2. Check the 12 volt fuses3. Check the electrical connections4. Check the battery

All of the water should be drained from the fresh water system when the unit is not in use for more than one week. For more detailed information regarding the water pump, refer to the water pump manufacturer's brochure in your Owner's Package.

City Water Hook-Up

When connecting your unit to city water, be certain to use a water hose manufactured and labeled for potable water. This will ensure that the hose will not alter the taste of the water. To hook the city water supply to the unit, connect one end of the hose to the city water supply. This will usually be a faucet or valve similar to your garden hose valve at home.



Turn the city water supply on for a few seconds in order to clear the line. Once the hose has been flushed, turn the supply off. Connect the other end of the hose to the city water connections. Turn on the water supply and open all of the faucets to clear the air from the lines in the unit. Once air pockets have been purged from the water lines and water flows freely, close all of the faucets. The city water supply is under pressure, therefore the water pump is not necessary when connected to city water. Once the city water fill valve is opened, water is supplied to the fresh water system including the hot water heater, faucets, and stool. To disconnect from the city water supply, close the valve and remove the hose from the city water supply. Disconnect the hose from the city water connection and store the hose in the water compartment.

Fresh Water Tank Fill

The fresh water tank is filled from the city water hook-up. The valve located in the service compartment near the water hook-up determines whether the city water is going through the water system or into the fresh water tank. An additional way to fill the fresh water tank is with the winterizing intake hose placed in a bucket of water (See Chapter 14). Since there is not an automatic shut-off for the fresh water tank fill, check the level from the monitor panel while filling the unit. The excess water will be vented from an overflow vent pipe onto the ground when the tank capacity has been reached. This pipe is installed in the fresh water tank to prevent tank rupture from overfilling. All of the water should be drained from the fresh water system when the unit is not in use for more than one week. Whenever possible, drain the fresh water tank before traveling. Water in the tank will reduce the carrying capacity of the unit.

SANITIZING

To assure complete disinfecting of your fresh water system, it is recommended that the following procedure be followed on a new system, on one that has not been used for a length of time, or one that may have become contaminated. This procedure is also recommended before long periods of storage, such as over the winter months:

1. Drain the fresh water tank by opening the drain valves. There is one valve per water tank. All of the faucets should be in the closed or off position.
2. Prepare a chlorine solution using one gallon of water and $\frac{1}{4}$ cup of chlorine bleach (5% sodium hypo-chlorite solution). Prepare enough of the chlorine solution to administer one gallon of solution for every 15 gallons of tank capacity. For sanitizing this unit, prepare $4\frac{1}{2}$ gallons of the chlorine solution. This mixture puts a 50 PPM (parts per million) residual chlorine concentration in the water system that will act as a quick kill dosage for harmful bacteria, viruses and slime forming organisms. Concentrations higher than 50 PPM may damage the water lines and/or tank.
3. Once the fresh water tank is empty, close the drain valves on the water tank.
4. Pump the chlorine solution into the tank. This is done by placing the winterizing hose into the chlorine solution. Close the valve from the fresh water tank to the pump and open the valve from the solution to the pump. Turn the tank fill valve from city water to tank fill. Turn on the water pump until all of the solution is pumped into the fresh water tank.
5. Turn off the water pump. Close the valve to the solution. Open the valve from the tank to the water pump. Fill the water tank with the city water tank fill (or by using the same method as was used to put the sanitizing solution into the tank). Remove the water filter (from the drink dispenser faucet, if installed) and install the by-pass pipe to allow the sanitizing solution access to the faucet. Open each faucet in turn including the kitchen faucet, bath faucet, inside and outside shower, turning on both the hot and cold, and flushing the stool until all of the air has been purged from the pipes and the water runs freely. The entire system will then be filled with the sanitizing solution.
6. Allow the 50 PPM disinfecting solution to stand in the system at least four hours.
7. Drain the system and flush with fresh water. The water system needs to be flushed with clean water repeatedly, if necessary, until there is no chlorine taste or smell left in the system. To remove any excessive chlorine taste or odor that might remain, prepare a solution of one quart vinegar to five gallons of water. Allow this solution to agitate in the tank for several days by vehicle motion. Drain the solution and refill the tank with clean water.

Drink Dispenser with Water Filter (Optional)

If this unit is equipped with a water filter, it must be removed before disinfecting the fresh water system. First remove the water filter and install the by-pass pipe to allow the sanitizing solution access to the drink dispenser faucet. The water filter is located under the kitchen sink. The filter will remove chlorine, dirt, and other matter. It will also eliminate most phenol (or similar) odors and tastes while delivering sparkling, taste free water for drinking and cooking. The filter is connected only to the cold water line that is attached to the drink faucet. The filter is not guaranteed to remove the tastes and odors of iron and sulfur. To remove these tastes you will need to chlorinate the water. Replacement filters are available that will filter iron and sulfur. Ask your dealer or RV supply center about acquiring an iron and sulfur filter. If you are traveling in an area where the water has a high iron and sulfur content, then add 1 tablespoon of chlorine bleach to every 10 gallons of water in your tank. This will precipitate the iron or sulfur so that the filter can remove it. If you are at a site where the unit is hooked up to city water, you will not be able to chlorinate the system because the water flows straight to your faucets and not through the fresh water tank. Filters should be changed every 6 - 12 months depending on the quality and quantity of water that is used in your unit.

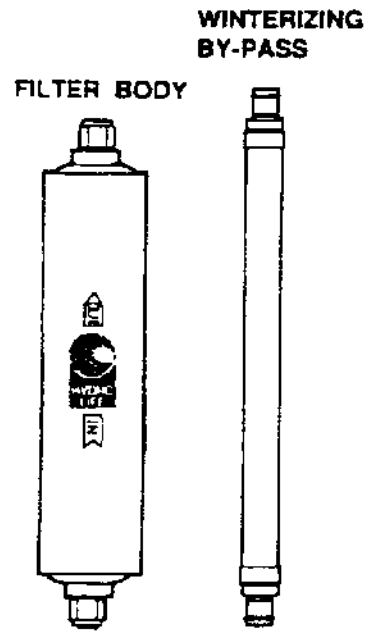

Water Heater By-Pass System

The water heater by-pass valve is located in an outside compartment near the water heater. By closing the water heater supply valve and opening the by-pass valve you can divert water away from the water heater. This is done when winterizing your unit. Using the by-pass will keep antifreeze out of the water heater when winterizing the system. Draining the water heater during winterizing is a MUST.

Fresh Water Lines

Vibration and flexing during traveling can cause pipes and fittings to work loose. Check all of the plumbing connections for leaks on a yearly basis. If the water pump runs when all faucets are turned off, check for a leak. Be sure the drain valves are closed. Connections at the kitchen and bathroom faucets normally seal with hand tightening and a half turn with a wrench. If a fitting leak persists, disconnect it completely and check for mineral deposits or foreign material on the sealing surfaces. Clean the surfaces thoroughly and reinstall the fitting. Take the coach to an authorized service center for repairs if the system continues to leak. Follow the winterizing instructions given in Chapter 14 to reduce the risk of leaks caused by cracks from freezing pipes. Freezing damage can be extensive and expensive.

WASTE WATER SYSTEM

General Information

The waste drainage system was designed to provide adequate and safe storage and/or disposal of waste materials. All of the materials used in the making of this system are tested by a nationally recognized testing laboratory. The drainage system uses plastic piping and fittings connected to the sinks, toilet, and holding tanks. This provides for their drainage to an outside termination. The unit should be reasonably level for best operation of the system. There are two separate waste systems. The gray water system is for waste water from the sinks and shower. The black water system is generally for sewage waste from the stool. Each tank has its own control valve, and both tanks drain through the sewer drain hose.

Toilet

The stool operates with water from either the fresh water tank with the water pump on or the city water supply. Before using the stool, add water to the bottom of the tank. Refer to the 'BLACK WATER TANK' instructions in this chapter. The stool flushes waste directly into the black water holding tank. The stool uses high velocity water injection to produce a swirl effect in the bowl. The greatest problem that causes stool solids to build up in the holding tank is lack of liquids. When using your stool, it is wise to fill the stool 3/4 full of water. This will help to wash the solids away from directly below the stool and to ensure complete dumping of the holding tank. To add water to the stool bowl, lift up on the lever. To flush the stool, push down on the lever until the water swirls.

The stool requires little maintenance. Use an approved non-abrasive cleaner to clean the bowl. Spraying the bowl sealing blade with a silicone spray will retain the original smooth operating condition.

Check the complete instruction and trouble shooting guide in the stool manufacturer's Owner's Manual provided in the Owner's Package.

P-Traps

Each of the sink drains, the shower drain, and the washing machine drain (if equipped) has a water trap (P-Trap) to prevent holding tank odors from entering the coach. These traps must have water in them in order to trap the odors. While traveling, the water may splash out of the sink and shower drains. While stored, the water may evaporate allowing an odor to enter the coach. If this occurs, run water from the faucet into the drain, allowing water to fill the trap.

Black Water Holding Tank

The black water, or sewage, holding tank is located directly beneath the toilet. Before using the stool, you will need to treat the tank with water that is mixed with an odor controlling chemical. These chemicals are readily available at any RV supply store. Be careful not to spill the chemical on your hands, clothing, or the carpet because it may cause a permanent stain. Pull the toilet levers forward to allow the chemical to mix with the toilet water. Continue

pulling the toilet levers until at least one inch of solution is directly under the toilet. Release the levers, and the waste tank is ready for use.

CAUTION

Use only approved RV odor controlling chemicals in the holding tanks. Products containing ammonia and petroleum will damage the ABS plastic holding tanks and seals.

Gray Water Holding Tank

The gray water holding tank is located in the underbelly of the unit. It is primarily used for the drainage from the kitchen and bath sinks and the shower.

Waste Water Disposal

Both of the holding tanks terminate in a valve arrangement that permits draining each tank separately or together. It is recommended to drain the black water tank before the gray water tank. This will allow the water from the gray tank to wash the black water residue from the drain lines and hose. The valves that open to release the water are called gate valves. The blade that closed the opening in the sewer drain pipes is connected to the T-handle to release the contents of the tank(s) when pulled. The sewer line must be securely capped during self-containment use to prevent leakage of waste material onto the ground or pavement. Do not pull the holding tank gate valve open when the protective cap is installed on the pipe. Always drain the tank into an acceptable sewer inlet or dump station.

WARNING

Holding tanks are an enclosed sewer system and must be drained into an approved dump station. Both black and gray water holding tanks must be drained and rinsed thoroughly on a regular basis in order to prevent the accumulation of harmful or toxic materials.

Whenever possible, drain the holding tanks prior to traveling. The carrying capacity of your unit will be reduced if water is left in the black or gray tanks.

The holding tanks should only be drained when they are at least $\frac{3}{4}$ full. Doing this will provide sufficient water to allow the complete flushing of waste materials in the drain lines and hose. If the tanks are not $\frac{3}{4}$ full, add enough water to allow for sufficient flushing.

To empty the waste water tanks, connect the adapter to the drain hose. Use the adapter supplied with your unit. If the adapter is lost or broken, one can be purchased from any RV supply store. Once you have placed the adapter on the drain hose, it can remain there for the life of the hose. One end of the hose threads up through the hole in the bottom of the service compartment, and the other end of the hose feeds into the sewer at the dump station. Unscrew the cap off the drain. Connect the hose with the adapter in place to the drain fitting. Open the gate valve all the way by pulling on the T-handle. The tank will start to drain as soon as

the T-handle is pulled. After you have drained the black water tank, immediately drain the gray water tank. Doing this helps to flush the black water from the sewage hose.

When both of the tanks are empty, flush them with a fresh water rinse before you close the valves. The gray tanks are easily flushed by pouring a couple of gallons of water into a sink drain. The drain outlet is engineered for quick release of the drain hose adapter. Always close the gate valves and secure the end cap to prevent leakage while in transit. After draining the black water tank, it is recommended to add a holding tank deodorant (such as Thetford Aqua-Kem) to help control the odor and break down the solids. Follow the instructions given on the holding tank deodorant package.

When using dump stations for draining the holding tanks, keep other travelers in mind. Practice good housekeeping. Leave the dump stations in good order. Above all, do not pollute.

Camping with Sewer Hook-Up

When camping at parks with sewer hook-up, it is important to keep the black water holding tank gate valve closed at all times, except when dumping. The gray tank can be kept open while hooked to a sewer connection but again, the black water tank must be kept closed. This is done so that an ample supply of liquid remains in the tank to provide a smooth flow through the gate and drain valve when dumping. Sufficient liquid in the tank causes a swirling action that should take any accumulated solid wastes with it. Accumulation of solid wastes in the black water tank can be avoided by keeping the gate valve closed when connected to the sewer hook-up. If the valve is left open, solid wastes may accumulate in the tank. This may eventually result in costly repairs.

CAUTION

The gray tank valve needs to be in the open position when operating the optional washing machine.

No Fuss Flush

This unit may be equipped with an optional flushing system for the holding tanks. When draining your sewer tank, attach a water hose to the sewer spray hookup. After the tank is drained, leave the gate valve open and open the water valve to allow water to spray inside the sewage tank. This will clean the inside of the tank of any debris that may be left inside the tank. After this is done, disconnect the water hose and close the gate valve. When unsure if any solids are still left inside the tank, fill the sewage tank with approximately ten gallons of water through the stool. As you travel, the agitation of the water should help liquefy any solids left in the tank. You can dump the sewage tank again at your next destination.

CAUTION

Do not use the same hose for the No Fuss Flush that is used for filling the fresh water tank.

CHAPTER 12

CONSTRUCTION FEATURES

Table of Contents

Construction Features	12-1
---------------------------------	------

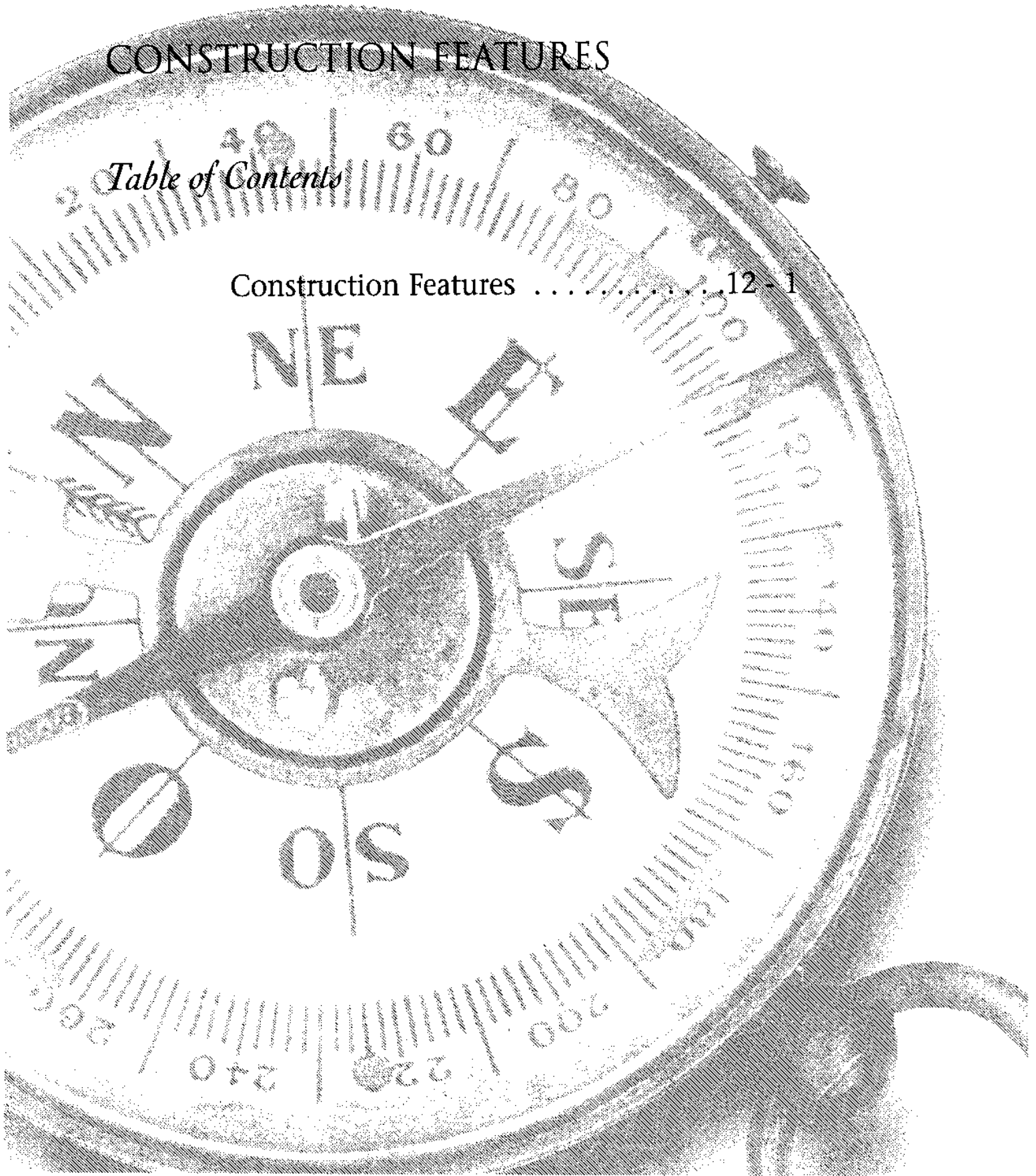

CONSTRUCTION FEATURES

The floor decking is constructed of durable $1\frac{9}{32}$ " structure wood. The fiberglass insulation in the floor and sidewall is rated at R7, while the roof is rated R11. The rear bumper pulls out with a slide out tray for the standard spare tire.

On this model, each sidewall is constructed for strength and is well insulated for comfort. Welded for added strength, the extruded aluminum sidewalls and roof are built with 16" on center framing to provide a strong and durable construction. The inside consists of $\frac{5}{8}$ " beaded foam that is laminated to kraft paper and covered by the interior paneling. A blanket of rolled insulation is added to the sidewalls, roof, and slide out to provide a greater efficiency and consistency of climate control. This will assist the furnace in the winter by keeping the warm in and the cold out. In the summer months, it will assist the air conditioning by keeping the cool air in and the hot air out.

Below are examples of the framing and insulation similar to that in your unit.

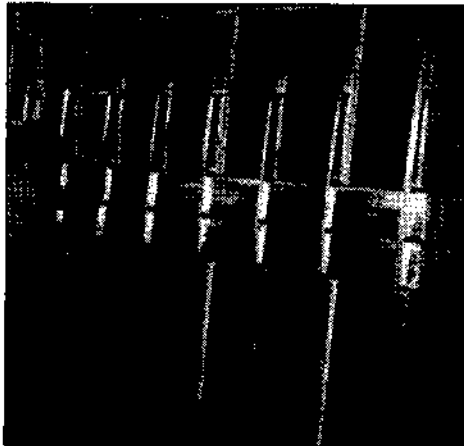
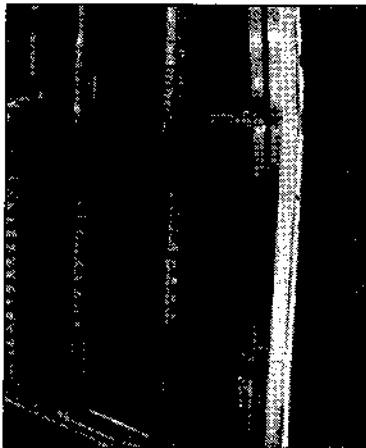

CHAPTER 13

WINDOWS, AWNINGS, VENTS & DOORS

Table of Contents

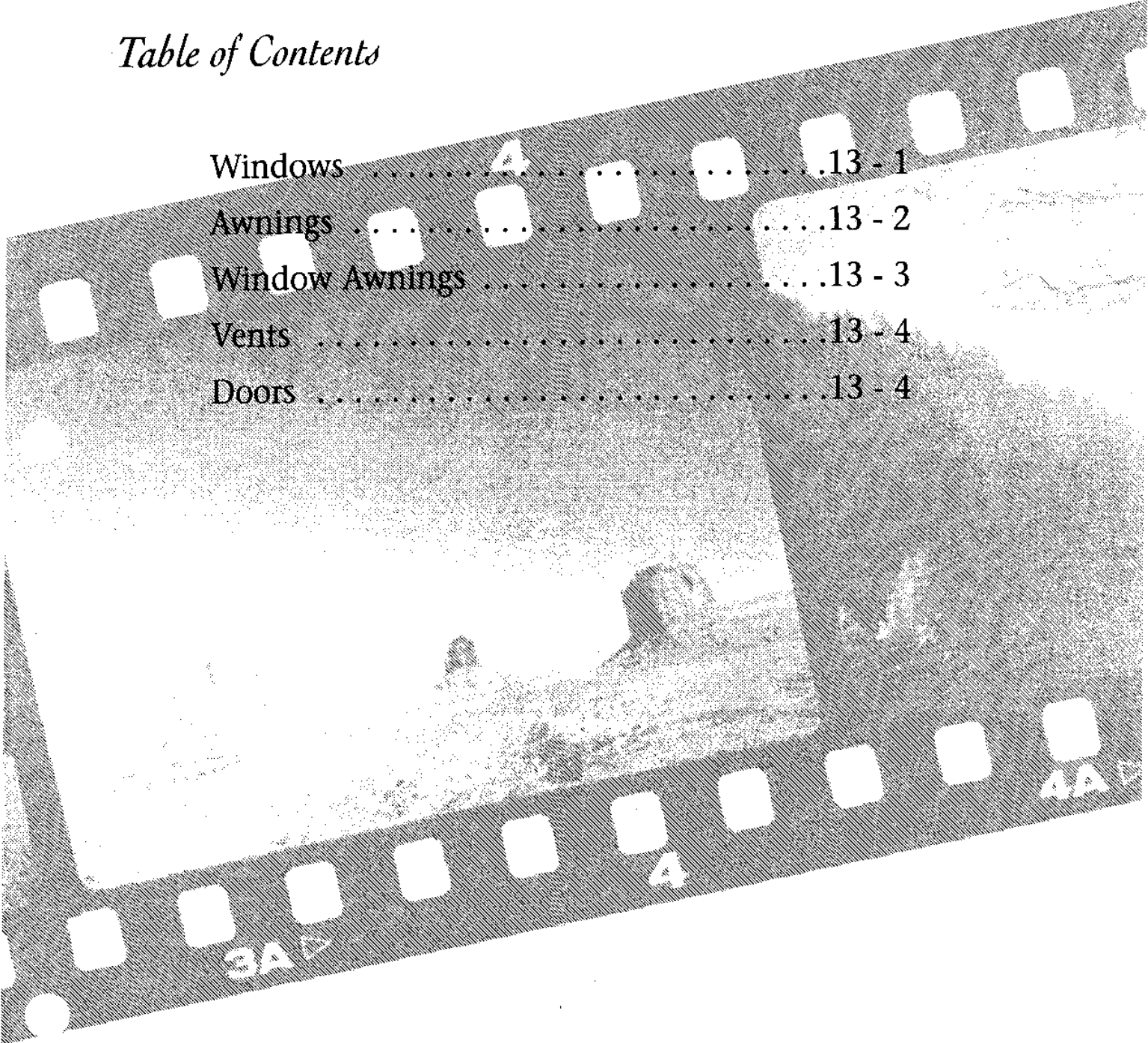

Windows	13 - 1
Awnings	13 - 2
Window Awnings	13 - 3
Vents	13 - 4
Doors	13 - 4

WINDOWS

The windows installed in this unit are the radius torque style tinted safety glass. These windows are also referred to as jalousie windows. They open with the simple turn of a crank. Optional are the double pane windows, except in the driver and passenger area. Also optional is the installation of a driver's side door with a window.

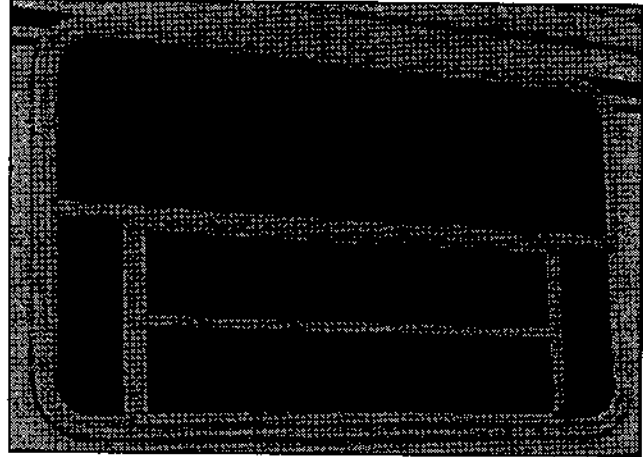

In the bedroom of the unit, one window will be marked "EXIT." This window is an emergency escape, or egress, window. To open in case of an emergency, lift the red handles at the bottom of the window and push out.

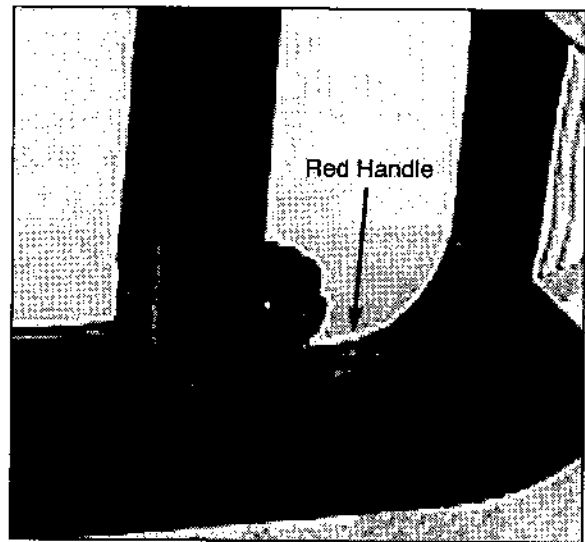

Notes

AWNINGS

Side Awning (Optional)

The A & E side awning is an optional feature for this unit. The following instructions will help in extending and retracting the awning.

EXTENDING

1. Loosen the black adjustment lock knob behind each main arm. Flip the travel lock latches up.
2. Using the provided pull rod, reach up and pull the locking lever forward to release the awning.
3. Hook the rod into the loop of the pull strap and pull the awning all the way out.
4. Slide one rafter arm up until it snaps into place. Push down on the main arm to remove slack from the fabric, and tighten the black adjustment knob. Repeat on other side.
5. Slide the pull strap to the right end of the roller and wrap it around the main arm.
6. Pull up on the lift handle and raise the arm assembly to the desired height. Swing the handle in and allow the lock button to snap into one of the holes. Repeat on the other side.
7. Press the release lever at the bottom end of one main arm, pull the arm assembly outward to a vertical position, and readjust height. Repeat on the other side. Drive provided stakes through holes of each patio foot into the ground.
8. During rain, lower one end to allow water to flow off.

CAUTION

Whenever heavy or prolonged rain or wind is anticipated, or you will leave the awning unattended, it is best to close the awning. Damage as a result of weather is not covered by warranty.

RETRACTING

1. Pull the stakes from the ground, swing the arm toward the vehicle, and snap the patio foot into the bracket. Repeat on the other side.
2. Raise the lift handle to release the lock button. Lower the main arm to the stop plug. Swing the handle in to engage the lock button in a hole. Repeat on other side.
3. Loosen black adjustment knob, lift slider catch, and slide the rafter arm down to the bottom of the main arm. Leave the black adjustment knob loose. Repeat on other side.
4. Grasp the pull strap and pull toward you. Flip the locking lever to the ROLL UP position. Hold the awning in the down position until you are ready to roll up the awning.

CAUTION

The awning will try to roll up as soon as the locking lever is flipped to the "ROLL UP" position.

5. Slide the pull strap to the center and using it to control speed, allow the awning to return to the side of the vehicle. Allow the strap to wind diagonally to prevent a bulge in the fabric.
6. Tighten the black adjustment knob and flip the travel lock latch down. Repeat on other side. The awning is now ready for travel.

Window Awning (Optional)

Also optional for this unit are the matching A & E window awnings. To operate, follow these instructions.

EXTENDING

1. Grasp the loop on the pull strap and pull down to extend the awning. Then hook the loop onto the window strap hanger.

RETRACTING

1. Remove loop on the pull strap from the window strap hanger.

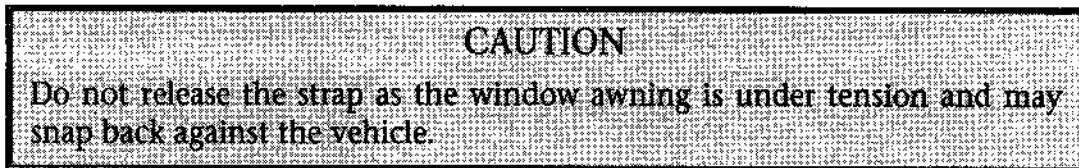

2. Slowly allow the awning to roll back to the closed position by feeding the pull strap upwards and diagonally. This prevents the strap from building up and creating a bulge in the fabric.
3. The window awning is now ready for travel with no further locking required.

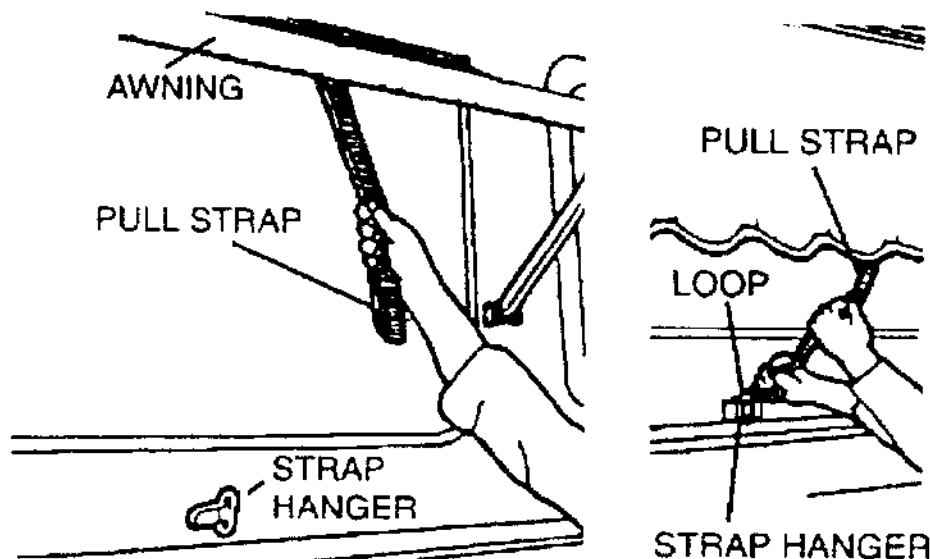

Vents

A standard feature in the kitchen is the 12 volt Fantastic Vent. This vent is equipped with a rain sensor on the roof hood. If the vent is open and it senses rain, it will automatically close. The vent is controlled by the wall thermostat. Once powered "ON" and the desired temperature is selected, the vent will run until the temperature is reached. When the temperature is reached, the vent will automatically shut off.



The vent installed in the bathroom is also powered by 12 volt electricity. This vent is controlled by the ON/OFF switch located on the wall. Optional is the Fantastic Vent.

Also standard in the bathroom is a skylight located above the tub/shower. An assist handle may be installed as an option in the tub/shower.

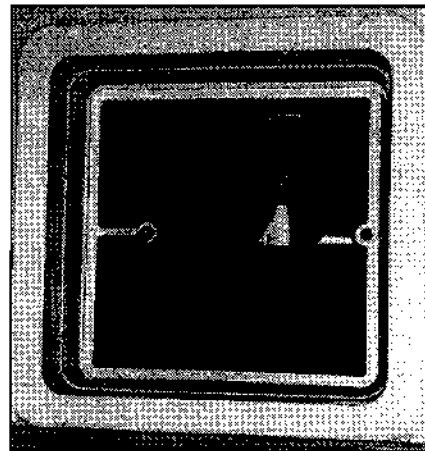

Doors

The entrance door is a radius door with a dead bolt lock for added security. The door can be held open with the door stop. With the door open, simply lift the "T" section on the door and place it in the holder on the exterior sidewall of the unit. Next to the entrance door you will find the exterior lighted acrylic assist handle. This handle may be used to assist anyone entering the unit.

Notes

CHAPTER 14

ROUTINE MAINTENANCE

Table of Contents

Washing	14 - 1
Waxing	14 - 1
Seals	14 - 2
Proper Sealants	14 - 2
Striping & Decals	14 - 2
Simulator Care	14 - 3
Rubber Roof Care & Maintenance	14 - 3
Interior Care	14 - 4
Carpet	14 - 5
Fabrics	14 - 5
Walls & Ceiling	14 - 5
Dash	14 - 6
Woodwork	14 - 6
Counter Tops	14 - 6
Accessories	14 - 6
Detectors	14 - 7
Condensation	14 - 7
Routine Maintenance	14 - 8
Winterizing	14 - 9

EXTERIOR CARE

IMPORTANT

Damage caused by improper or unapplied maintenance is not covered by your Newmar Limited Warranty.

Washing

The exterior of your new recreational vehicle is made of pre-finished aluminum and fiberglass. Frequent washings and thorough cleanings are required to prevent damage to the vehicle finish after exposure due to damaging salts, calcium chloride, road tar, tree sap, insects and other foreign material. Damage caused by exposure to these items is not covered by your warranty agreement. Never wash the vehicle in direct sunlight, while the vehicle is hot or with hot water. Build up of mud and dirt under the body can cause damaging rust on steel parts. Corrosive materials, such as those used for ice and snow removal and dust control, also accumulate on the underside of the vehicle. These materials should be removed by flushing the underbelly regularly with water, especially areas where mud and other foreign materials collect. The chance of corrosion can be minimized by frequent washings of the vehicle. When washing the vehicle, make certain that the undercarriage and the wheel wells are cleaned, as well as the exterior of the coach. Do not use strong soaps or detergents for washing the vehicle. Always use a mild soap in warm water, a commercially prepared product for automotive finishes or your local car wash. Be careful when using a pressure-type washer to avoid loosening any exterior decals or sealants, etc. After washing, carefully inspect the caulking around window frames and vents and any other joints that may have separated. Recaulking, if necessary, is relatively simple, and is considered routine maintenance which is the responsibility of the owner.

IMPORTANT

Never use a strong solvent, such as lacquer thinner or harsh abrasives, on any of the exterior painted surfaces.

Waxing

The exterior finish will require a routine waxing. When water will not bead and roll off a freshly washed vehicle, a new coat of wax is needed. Wax not only improves the appearance of the vehicle, but it also protects the finish against oxidation and corrosive materials. The recommended type of wax is one that is compatible with painted or gel-coated fiberglass finishes, and contains a UV (ultra-violet) inhibitor. Buffing with a polishing compound will improve a dull or discolored finish.

IMPORTANT

When using a polishing compound that does not contain a wax preservative, reapplying a coat of hard wax after polishing is recommended.

Seals

The seals around doors, windows, vents, slide out trim and external seams should be checked at least twice a year. In addition, the roof seams should be inspected twice a year for cracking or peeling. If deterioration is noted during a routine maintenance inspection, reseal the seams or seals with an approved sealant to prevent leaks. Your dealer can perform the resealing inspections and work for you. It is recommended that a Newmar Authorized Service Center perform these inspections, and reseal when necessary.

Proper Sealants for Application

Plas-T-Cote	Metal or fiberglass roof
Surebond #SB-140	Rubber laminated to metal roof and <u>ALL SKYLIGHTS</u>
Carlisle #502-LSW Self Leveling Sealant	Rubber roof over wood base
Silicone Sealant	To cover butyl and other sealants; not to be used as the main sealant
Parbond	To seal across tops of windows, etc. on exterior where silicone is not used

Striping & Decals

The striping and decals on your vehicle require little maintenance. Treat these as you would any painted surface on your vehicle. Wash them with mild soap and warm water, or any retail car soap. Never wash the vehicle in direct sunlight, while the vehicle is hot or with hot water. Rinse thoroughly to prevent soap residue accumulation. Use caution with high pressure wash nozzles. Keep them at least 18 inches from the edge of the decals. High pressure water may cause the decals to loosen and peel. Test small sections of decals when using any type of cleaning solution.

IMPORTANT

Do not use solvents such as acetone, MEK, toluene, etc. on the decals. Any solvent including alcohol may soften or smear colors. Do not use lacquer thinner or paint on decals. Do not overcoat the decals with clear paint. Do not allow gasoline or other fuels to drip or stay on the decals for any length of time. If this occurs, immediately flush the area with water.

Simulator Care

The care and maintenance of your Dicor stainless steel wheel product is simple and requires no special material or products. All Dicor products are constructed of highly polished 304L stainless steel. Timely care and cleaning will keep them looking great for many years. We suggest the following care:

1. Clean your Dicor wheel cover/liner on a regular basis to keep road dirt from building up.
 - A. Rinse with clean water to remove loose dust and dirt.
 - B. Clean with a mild soap and water solution. (Any non-abrasive household detergent works fine.) Apply with cloth, sponge, or soft bristled brush. Use solution liberally to avoid surface scratching due to trapped dirt on the applicator.

IMPORTANT

Do not use harsh detergents, acids, or abrasives which may scratch or dull the surface. The applicator cloth, sponge, or soft bristled brush should be non-metallic and non-abrasive.

- C. Rinse thoroughly with clean water to remove excess soap and dirt.
 - D. Repeat above steps as required.
 - E. If stubborn stains persist, such as road tar, brake dust, oil, etc., use only a product compatible with stainless steel. An over-the-counter window cleaner (like Windex) will often remove foreign material. If a harsher cleaner is needed, we recommend "NEVR-DULL," available at many general hardware or automotive stores.
2. Surface rust: From time to time, surface "spin out" rust may appear on the stainless steel. Normally the "spin out" rust comes from the wheel, lug nuts, locator pins, etc. In many cases, regular normal cleaning of your decorative wheel product, as indicated above, will remove any surface rust. If, however, a stubborn rust spot remains, utilize "NEVR-DULL" (a wadding polish), applying constant pressure to remove any surface blemish. You may have to repeat this process on hard to remove spots. After cleaning with "NEVR-DULL," you may want to re-shine your wheel products using Windex or a similar product.
3. Petroleum based tire conditioners: While the use of these products (Armor-All, Son-of-a-Gun, etc.) may improve the appearance of your tires, these types of products will form a film on your stainless steel wheel cover product. To remove, use a mild cleanser, like Windex, to restore the shine.

IMPORTANT

Remember to periodically check the tightness of your wheel cover product.

Rubber Roof Care & Maintenance

Proper care and maintenance of your recreational vehicle, including your rubber roof, is important for trouble-free performance. Normal maintenance is simple and easy, and does not require special materials.

Keep the roof clean. Clean the roof at least four (4) times annually. For normal cleaning:

1. Use a mild laundry detergent. ZEP - Formula 50 Heavy Duty All Purpose Cleaner and Degreaser, Top Job and 409 may also be used. Do not use general purpose cleaners containing petroleum solvents, harsh abrasives or citric-based cleaners.
2. Rinse the complete roof with clean water to remove any loose dirt or debris.
3. Using a medium bristle brush, along with your selected cleaner mixed with water, scrub the entire roof. Rinse thoroughly with clean water to avoid residue build up on the roof or sidewall of the vehicle.
4. For more difficult stains, you may use cleaning materials mentioned above in a more concentrated mixture. For stubborn stains, use of a rag dampened with mineral spirits is recommended. DO NOT use mineral spirits in a large area or allow it to soak in the roof membrane. Household bleach can also be used (fully concentrated) and allowed to soak in stubborn stain areas, then scrubbed with a medium bristle brush or rag. Rinse thoroughly.

WARNING

Use caution when working on top of your vehicle. The wet roof membrane may be extremely slippery.

INTERIOR CARE

WARNING

Urea-formaldehyde is used in the productions of particle board, hardwood plywood, and most paneling. Urea-formaldehyde resin may release formaldehyde vapors into the air, which may cause headaches, and in some people, eye, nose and throat irritation. Formaldehyde may intensify some allergies or upper respiratory problems like asthma. Proper ventilation should reduce the risk of such problems.

IMPORTANT

The fading of upholstery, carpet and other interior fabrics is generally caused by excessive sunlight. The drapes, blinds or shades should be kept closed when the vehicle is parked for an extended period of time to minimize the fading. Normal deterioration of appearance items due to wear and/or exposure is not covered by the Newmar Limited Warranty.

Carpet

A weekly routine of vacuuming the carpet and fabrics, throughout the vehicle is recommended. Doing this will prevent an accumulation of dirt that can detract from the materials appearance and shorten its life.

Included in the Owner's Information Package is the carpet manufacturer's Carpet Care Guide. The Carpet Care Guide lists detailed information on cleaning soiled areas and removing stains from the carpet installed in the unit.

Fabrics

The fabrics used in this motorhome for the bedspread, draperies, headboard and valances contain fire-retardant additives that may be damaged by use of improper cleaning products. Cleaning instructions for these fabrics are DRY CLEAN ONLY. **Water-based products are not recommended for cleaning the fabrics in your new unit.** Most water-based household cleaning products are not formulated for use on these fabrics and may cause excessive shrinkage or fading. Always test any cleaning product on a hidden area of fabric before using on visible areas. For best results, the fabrics in this unit should be cleaned by a professional carpet and upholstery cleaner.

Spills, spots or stains should be treated as soon as possible to avoid permanent damage. If a spill occurs, blot the fluid with a dry towel. Do not rub the spill. Rubbing may cause the liquid to "set" in the fabric. When attempting to clean a spot or stain, always start from the outside and work inward to avoid spreading it further. Some stains or soils are extremely difficult or impossible to be removed completely. These should receive immediate, professional attention. Spills, spots, stains or soils are the responsibility of the owner, and are not covered by the Newmar Limited Warranty.

WARNING

When cleaning the upholstery and fabric in the unit, do not use lacquer thinner, nail polish remover, laundry soaps or bleach. Never use carbon tetrachloride or gasoline for cleaning purposes. These items may cause damage to the materials being cleaned, and most are highly flammable.

Walls & Ceiling

The wall and ceiling coverings should be cleaned periodically to maintain a new appearance. Use a non-abrasive cleaner with a soft cloth on the walls. Do not use solvents of any kind. Solvents may damage the surface.

Notes

Dash

In order to keep the dash in like-new condition, follow these guidelines:

DO—

- Dust and clean the dash with a soft, damp cloth, or chamois, wiping the surface gently.
- Use a mild detergent and lukewarm water.
- Dry the surface, after washing and rinsing, by blotting with a damp cloth or chamois.

DO NOT—

- Use harsh chemicals that may damage the dash.
- Use cloths containing grit or abrasive particles or kitchen scouring compounds to clean or dust the dash.
- Subject the dash to hard, direct blows.
- Use boiling water, strong solvents or other materials listed below to clean the dash, as they will soften the plastic.

Woodwork

The wood cabinetry should be cared for with furniture polish to sustain the natural beauty and luster of the wood. This will also keep your cabinetry looking new, and prevent the wood from drying. The simulated plank flooring should be protected from dents, scratches and nicks by installing protective pads on the bottom of chairs and tables. Use of area rugs and floor mats by the entrance door is recommended to trap dirt. To clean the flooring, begin by vacuuming the floor to remove loose dust and dirt. Then, damp mop the floor with one ounce of Wilsonart Flooring Cleaner diluted in one gallon of clean, warm water (or use a non-abrasive, soap-free cleaner). The mop should be damp, not dripping. Do not use soap-based cleaners, scouring powders, steel wool, abrasive cleaners, wax or polish on the floor. To remove stubborn spots like shoe polish, oil, tar, markers, scuffs, etc., use a household solvent, acetone or nail polish remover, then wipe with a damp cloth. To remove chocolate, grease, juice or wine, use warm water and a non-abrasive cleaner. To remove candle wax or chewing gum, carefully scrape off when the material has hardened. For further tips, please see the manufacturer's information sheet in your Owner's Information Packet.

Counter Tops

To properly care for the counter top in your new unit, always use a heat pad or trivet to protect the surface from hot objects that may mar or damage the surface. Wipe the counter top with a damp cloth to remove water spots. For most dirt and stains, wipe with soapy water or ammonia-based cleaners.

Accessories

The brass light fixtures, bath accessories and faucets can be cleaned by wiping with a soft, damp cloth. Washing with warm water will remove dry water spots. Do not use cleaners that contain harsh or abrasive chemicals. Alcohol or similar solvents should never be used.

Detectors

The CO and LP detectors (if equipped) are self-contained and DO NOT require any maintenance other than normal cleaning and dusting. The smoke detector installed in this coach is 9 volt battery operated. The battery needs to be tested periodically and replaced when necessary. When cleaning the case on any of the detectors, use a damp cloth or paper towel. Do not spray cleaners or wax directly into the case as it may cause false alarms.

Condensation

IMPORTANT

Since surface condensation within the coach cannot be controlled by the manufacturer, damage caused by condensation is not covered by your Newmar Limited Warranty.

Damage may occur to your unit if excessive condensation exists. Accumulation of condensation on surfaces within your unit occurs when warm, moist air contacts a cool surface. It is most evident on the inside of windows. This problem can be controlled by:

1. Slightly opening a window or roof vent to allow the moisture to escape from the unit.
 2. A small dehumidifier is also very effective in removing moisture from the air.
- Condensation levels are highest during times when a person is cooking or taking a shower in the unit, but these are not the only times condensation is present.
 - Condensation can migrate through ceiling panels and saturate the fiberglass insulation in your ceiling cavity. This condition often causes the occupants to believe the recreational vehicle has a roof leak. Walls and ceiling panels may also become wet when the moisture accumulates on these surfaces.
 - Newmar Corporation does not recommend the use of any catalytic heaters.

Notes

ROUTINE MAINTENANCE

IMPORTANT

Always follow the chassis maintenance guidelines found in the chassis manufacturer owner's manual.

All routine maintenance is the responsibility of the owner and is not covered by the Newmar Limited Warranty. Use the maintenance record found in Chapter 15 to record all performed maintenance as required. Please note that damage caused by improper or unapplied maintenance is not covered by the Newmar Limited Warranty.

Items supplied by other manufacturers may require specific individual maintenance not listed herein. Please refer to the manufacturers' suggested maintenance guidelines in the Owner's Information Packet.

IMPORTANT

Cosmetic adjustments and alignments must be performed within the first three (3) months from date of original purchase for warranty consideration. Thereafter, these items are considered routine maintenance.

Every Three (3) Months

- Clean range hood exhaust fan filter and blades.
- Check gas lines for leaks with soap solution or leak detector.
- Test smoke alarm, carbon monoxide detector and LP gas detector.
- Check operation of windows, latches and hinges.
- Clean the roof ducted air conditioner filter(s).
- Clean and inspect all door and window seals; reseal where necessary.
- Inspect and reseal around the tub and shower area where necessary.
- Lubricate the exterior door hinges and latches with a graphite (silicone) lubricant.
- Check, clean and tighten battery cables, and inspect batteries for proper fluid level.

Every Six (6) Months

- Inspect the slide out for proper seal. If realignment is necessary, please contact an Authorized Newmar Service Center.
- Inspect the exterior rubber slide out seals and apply a UV inhibitor, such as 303 Protectant.
- Rotate tires as recommended by the tire manufacturer.
- Check all gas appliances for proper operation.
- Have the LP system inspected by a qualified technician.
- Lubricate the moveable parts on the entrance step.

Annually

- Inspection of roof seams and joints should be performed by an Authorized Newmar Service Center. If resealing is necessary, it is the owner's responsibility and is not covered by the Newmar Limited Warranty.
- Sanitize the fresh water system.
- Wax the vehicle as described previously in this chapter.

Winterizing

To store your unit for the winter months, it is necessary to winterize the water system to help prevent freezing. To do this, follow these instructions:

1. The water heater must remain off during this process. Shut off the water pump and make sure the water supply valves are closed.
2. To drain the fresh water tank, open the drain valves.
3. Open the low point drain valves. There is one drain valve for each water line, one cold and one hot. This is done to drain all of the water out of the system.
4. After the water heater has cooled off, remove the drain plug to drain the water from the water heater. In the exterior compartment beside the water heater there are two water heater shut off valves and a by-pass valve. The shut off valves must be closed and the by-pass valve must be open, prior to winterizing to prevent the antifreeze solution from entering the water heater.
5. Close the low point drains to prevent the antifreeze from draining through the lines onto the ground.
6. Remove the water filter. See Chapter 11 for more information.
7. Close the water supply valve that flows from the pump to the tank.
8. Use only non-toxic antifreeze that has been approved for use in drinking/potable water systems. Place the in-take hose into the antifreeze supply. Open the antifreeze valve to allow the solution to flow freely. Once the water pump is turned on, proceed to the kitchen faucet, bath faucet, inside and outside shower, turning on the hot and cold, and flushing the stool until the antifreeze solution flows freely. If the unit is equipped with a washer, be certain to purge the air from it also. This forces the antifreeze through all of the water lines and faucets. It also allows the antifreeze solution to enter the drain lines and prevent the P-traps from freezing. Check the antifreeze solution from time to time to make sure there is an adequate supply.
9. Close the antifreeze valve when the winterizing process is complete. Store the in-take hose, and turn the water pump off.
10. Open the water supply valve that flows from the pump to the tank to help prevent freezing on that water line.

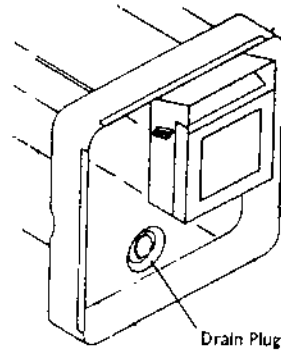

CHAPTER 15

CHARTS & DIAGRAMS

Table of Contents

Model Numbers	15 - 1
Maintenance Record	15 - 2
Fuel & Mileage Log	15 - 5
12 Volt Distribution Panel	15 - 7
30 Amp Electrical Panel	15 - 9
50 Amp Electrical Panel	15 - 11
Wiring Color Scheme	15 - 13
Typical Coach Wiring Diagram	15 - 17
Inverter Wiring Diagram	15 - 19
TV/VCR Wiring Diagram	15 - 21
Typical Fresh Water Diagram	15 - 23
Typical Drain Line Diagram	15 - 25
Typical LP Gas Diagram	15 - 27
Slide Out Mechanism	15 - 29
Parts Listing	15 - 31

IMPORTANT INFORMATION ABOUT YOUR KOUNTRY STAR CLASS A MOTOR HOME

Coach: Year 2000 Model _____ Serial # 7 _____

Appliance	Brand	Model	Serial
Refrigerator	_____	_____	_____
Water Heater	_____	_____	_____
Range	_____	_____	_____
Converter	_____	_____	_____
Washer	_____	_____	_____
Dryer	_____	_____	_____
Microwave	_____	_____	_____
Icemaker	_____	_____	_____
Television, front	_____	_____	_____
Television, rear	_____	_____	_____
Radio	_____	_____	_____
CD Player	_____	_____	_____
Generator	_____	_____	_____
Air Conditioner, front	_____	_____	_____
Air Conditioner, rear	_____	_____	_____
Video Cassette Recorder (VCR)	_____	_____	_____
Furnace, front	_____	_____	_____
Furnace, rear	_____	_____	_____

MAINTENANCE RECORD

DATE	MILES	DESCRIPTION OF SERVICE WORK PERFORMED	SERVICE PERFORMED BY	COST

MAINTENANCE RECORD

DATE	MILES	DESCRIPTION OF SERVICE WORK PERFORMED	SERVICE PERFORMED BY	COST

MAINTENANCE RECORD

DATE	MILES	DESCRIPTION OF SERVICE WORK PERFORMED	SERVICE PERFORMED BY	COST	

12 VOLT DISTRIBUTION PANEL

**HOT FEED LINES FROM BATTERIES
AND CONVERTER, WITH
OVERCURRENT PROTECTION**

**GROUND TO CHASSIS,
CONVERTER AND BATTERIES
MINIMUM SIZE #8**

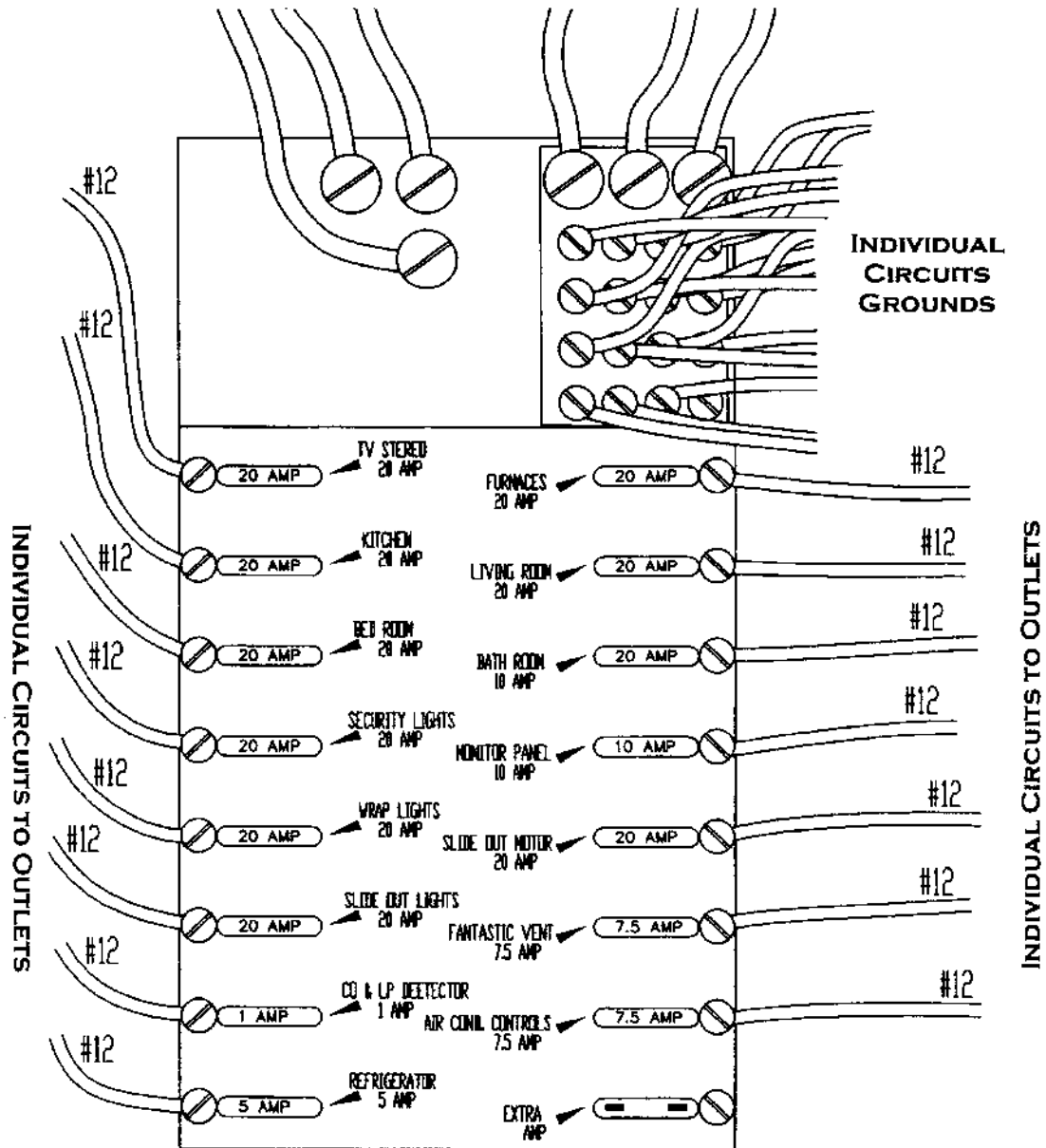

WIRE OVER CURRENT PROTECTION IS PER THIS CHART

WIRE SIZE	AMPACITY	WIRE SIZE	AMPACITY
# 6	55	# 8	40
#10	30	#12	20
#14	15	#16	8
#18	6		

30 AMP ELECTRICAL PANEL

load	protection
30 AMP MAIN	
AIR CONDITIONER	# 1
	20 AMP
MICROWAVE	# 2
	15 AMP
WATER HEATER	# 3
	15 AMP
REFRIGERATOR & 8 RECEPTS	# 4
	15 AMP
CONVERTER & 8 RECEPTS	# 5
	15 AMP

30 AMP 110 SERVICE

30 Amp lead in cord & wire = 10/2 w/ground
 20 Amp circuit wire = 12/2 w/ground
 15 Amp circuit wire = 14/2 w/ground

Maximum of 10 outlets (lights and recepts) on any 15 amp circuit with no other appliance on that line. Circuits 3 and 4 may have recepts as noted at left. NOTE: A duplex recept is counted as 1 recept.

Not all units will get all of these items
 This diagram is a typical only

WIRING COLOR SCHEME

16 GAUGE

Grounds	White
Back-up Lights	Yellow
Ignition to Power Step	Pink
Clearance & Running Lights	Green
Right Turn Lights	Brown
Left Turn Lights	Red
Ignition to Slide Out Motor	Pink w/Green
Class A Blower Fan (in holding tank area)	Orange
Slide Out Switch	Purple
Courtesy Lights (hot to switch)	Grey
Courtesy Lights (switched)	Grey w/White
Detectors, CO & LP	Red w/Black
Rear Center Brake Light	Blue
LP Fuel Gauge	Red w/Yellow
Air Conditioner Controls	Pink w/Black
Monoplex Water Pump Switch	Yellow w/Black
Vent Thermostats	Black

Water Heater DSI Switch Harness	{ Red w/White*
	{ Green w/White*
	{ Blue w/White*
Onan Generator	{ Red w/White*
	{ Green w/White*
	{ Blue w/White*
	{ Brown*
Powertech Generator	{ Blue*
	{ Gray*
	{ Yellow*
	{ White*

* - multiple applications for this color

WIRING COLOR SCHEME (CONT.)

12 GAUGE

Grounds	White
Living Room & Entryway Lights (hot to switch)	Red
Living Room & Entryway Lights (switched)	Red w/White
Bedroom Lights (hot to switch)	Orange
Bedroom Lights (switched)	Orange w/White
Bathroom Lights (hot to switch)	Brown
Bathroom Lights (switched)	Brown w/White
Kitchen Lights (hot to switch)	Green
Kitchen Lights (switched)	Green w/White
Wrap & Storage Compartment Lights	Black
TV and Stereo	Pink
Furnaces	Green w/Black
3 Way Switches (commons)	Red w/Black
Electric Brakes (tandem axle)	Blue
Fantastic Vent and Water Heater	Brown w/Black
Monitor Panel	Yellow
Refrigerator Controls	Red w/Yellow
Security Lights (hot to switch)	Purple
Security Lights (switched)	Purple w/White
Slide Out Module (hot feed)	Green/Yellow
Slide Out Motor & Voice Module	Black w/Yellow & Red w/Yellow
Slide out Lights	Gray
Water Pump	Yellow w/Black
Power Step Switch	Black w/White

WIRING COLOR SCHEME (CONT.)

10 GAUGE

Grounds	White
Living Room Entry Lights (hot feed)	Red
Bedroom Lights (hot feed)	Orange
Kitchen Lights (hot feed)	Green
Bathroom Lights (hot feed)	Brown
Freezer	Purple w/Yellow
Power Step (hot feed)	Green w/Black
Power Jacks	Yellow

8 GAUGE

Grounds	White
Battery	Red
Converter	Black
Solar Prep	Green
400 Watt Inverter (Class A)	Red w/White

16 GAUGE

MONITOR PANEL TANK HARNESS

Fresh Water Tank	{ White* Grey w/Black (replaces Red tank lead) * Black w/Yellow (replaces Blue tank lead) *
Grey Water Tank	{ White* Green w/White (replaces Red tank lead) * Blue w/Black (replaces Blue tank lead) *
Black Water Tank	{ White* Red w/White (replaces Red tank lead) * Blue w/White (replaces Blue tank lead) *

* - multiple applications for this color

TYPICAL COACH WIRING DIAGRAM

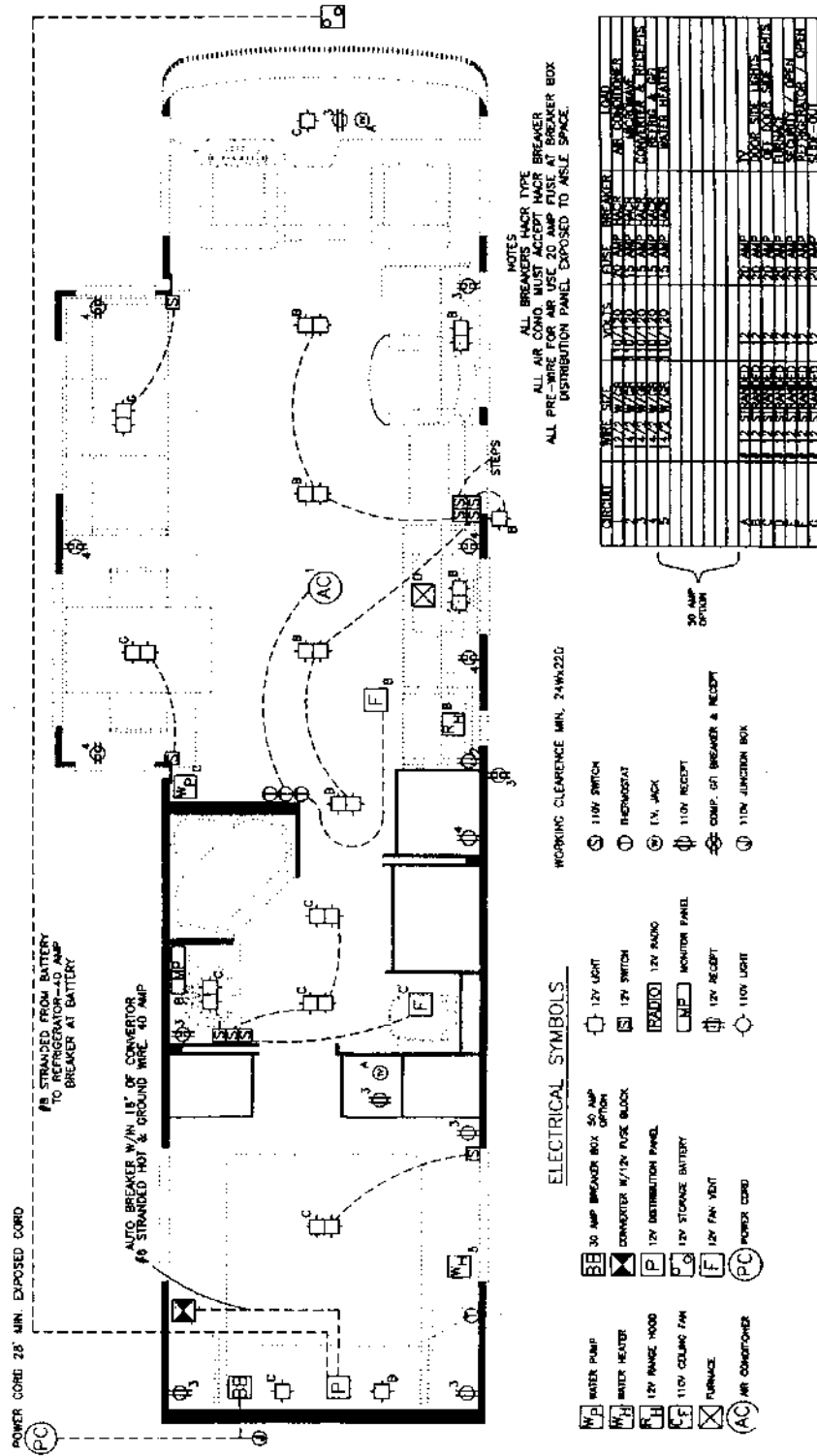

400 WATT INVERTER DIAGRAM

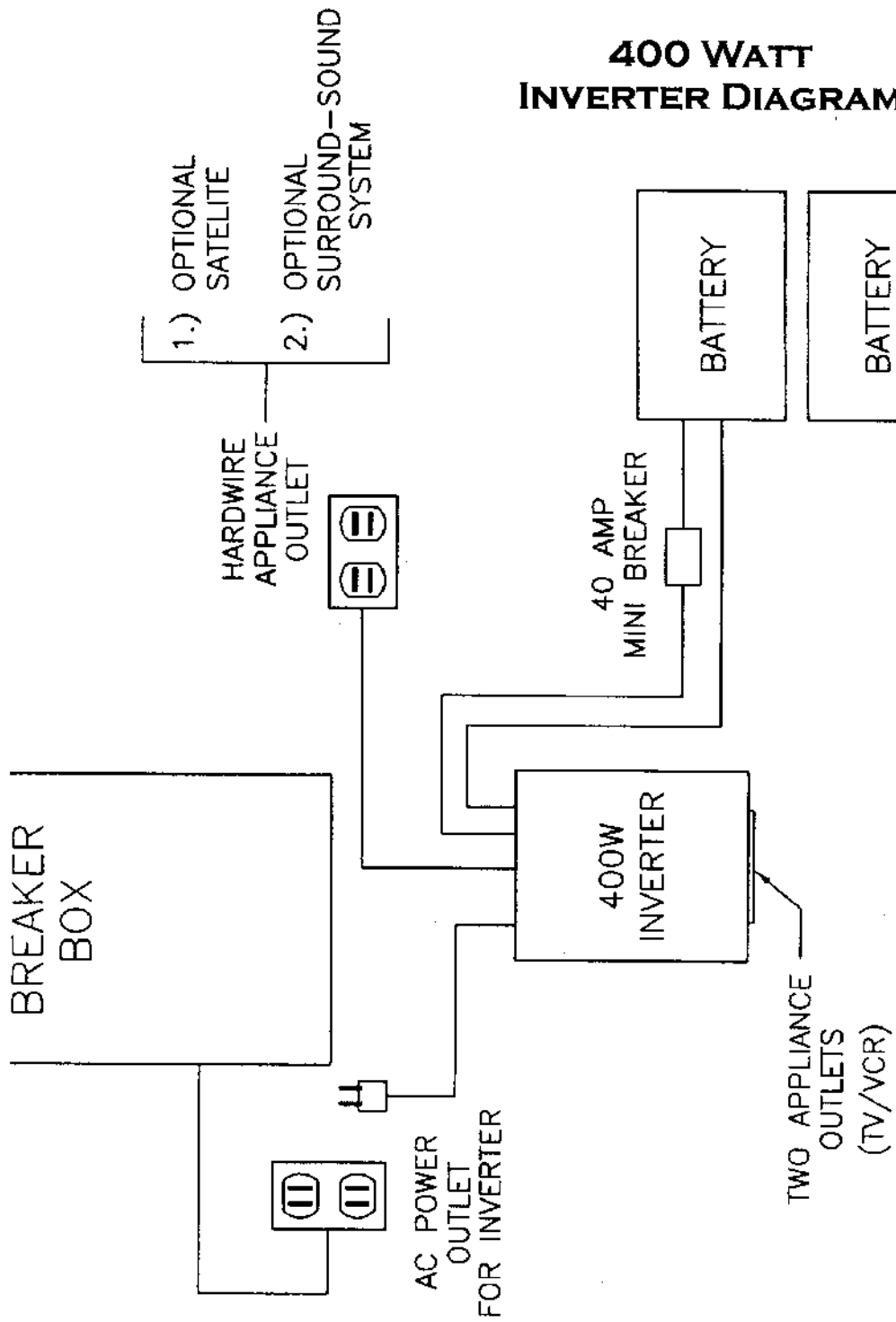

TV / VCR WIRING DIAGRAM

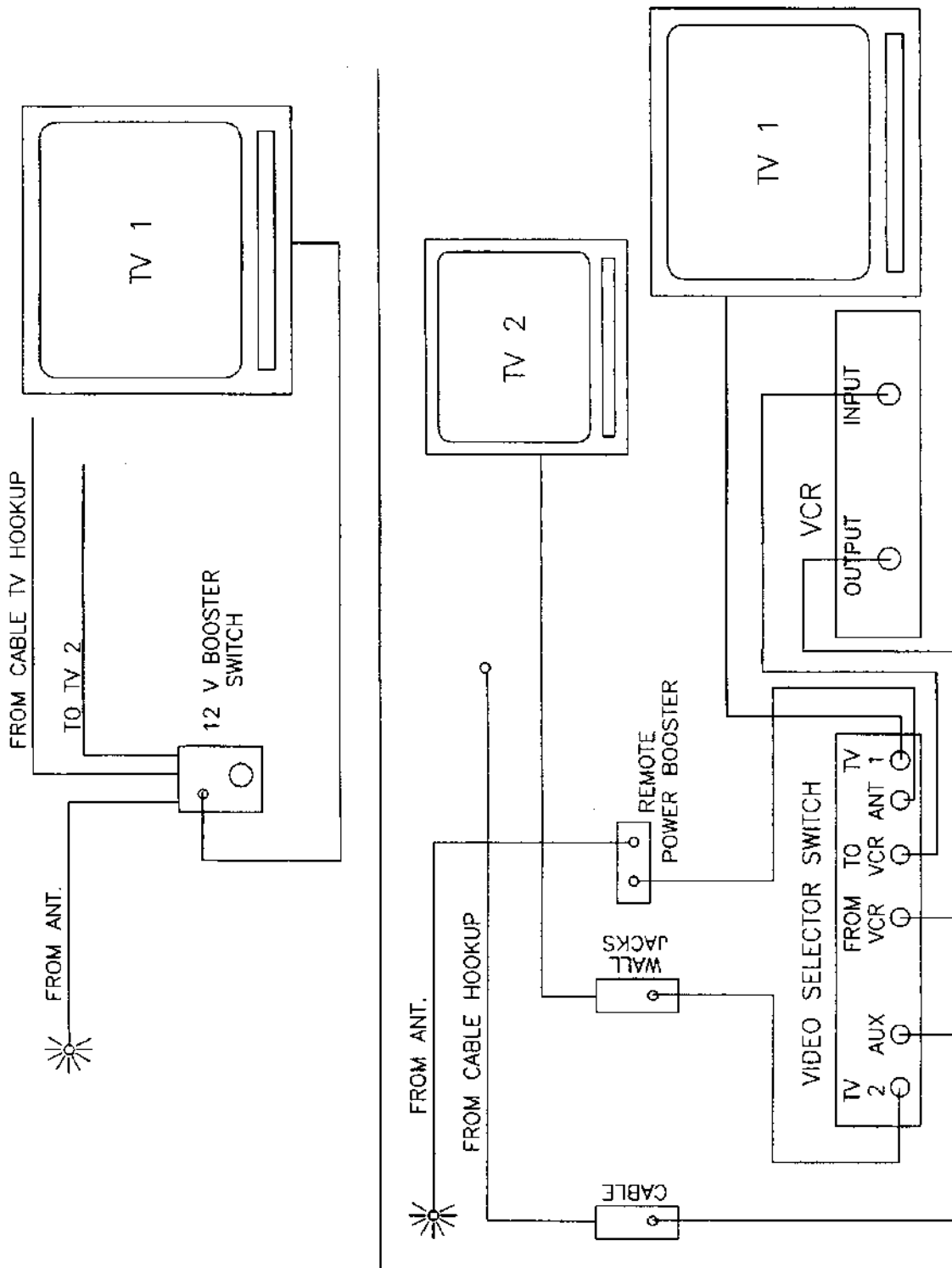

TYPICAL FRESH WATER DIAGRAM

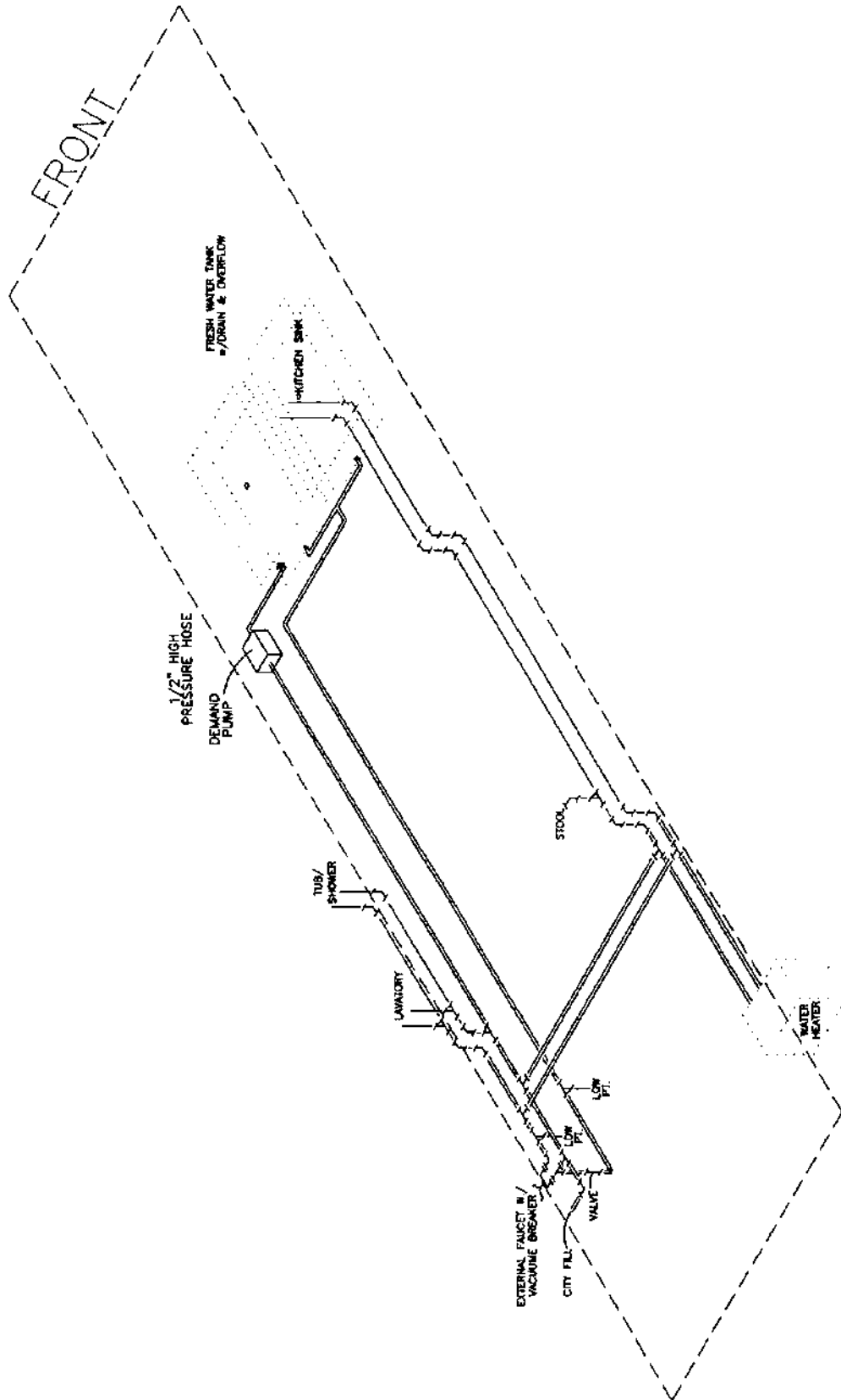

TYPICAL DRAIN LINE DIAGRAM

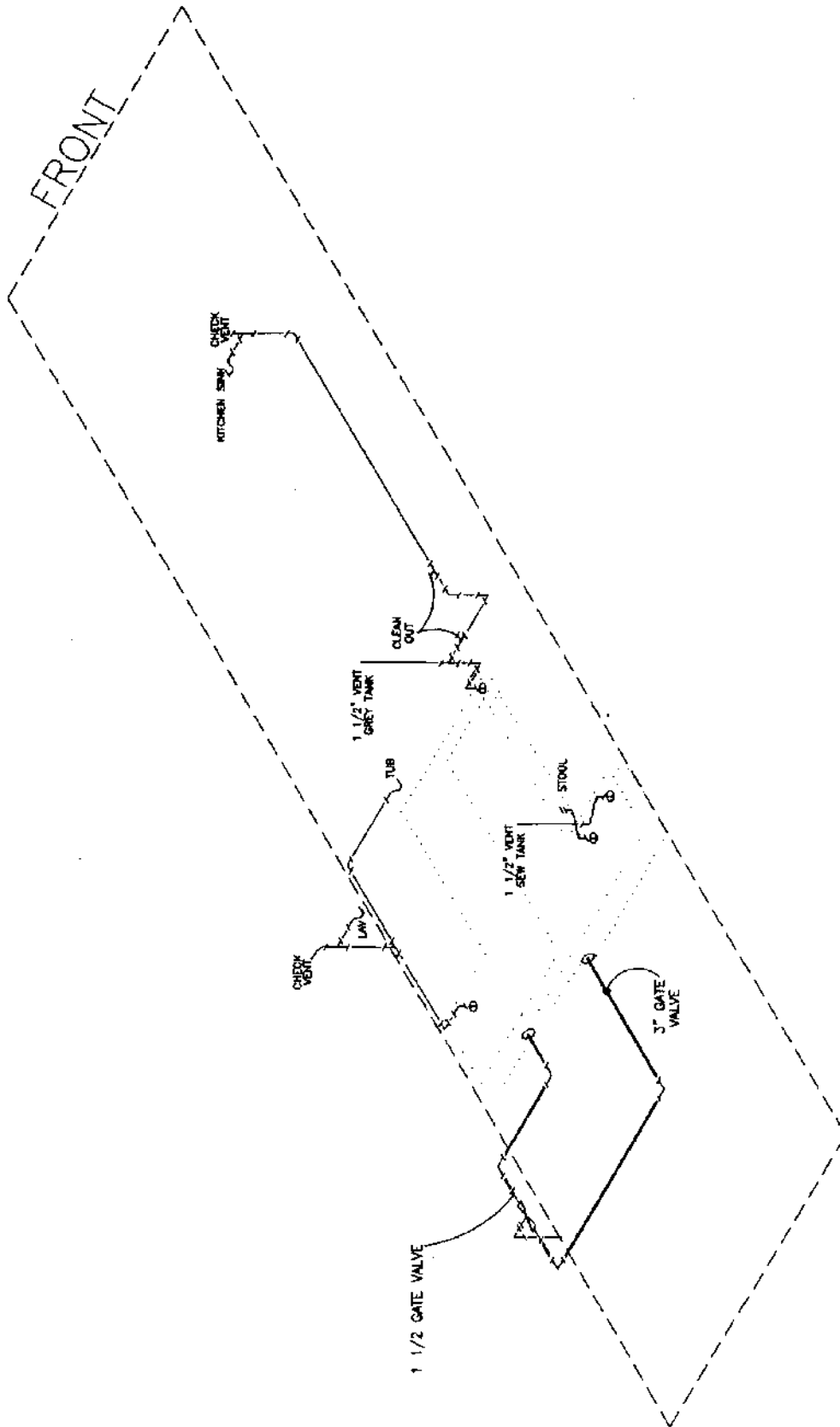

TYPICAL LP GAS DIAGRAM

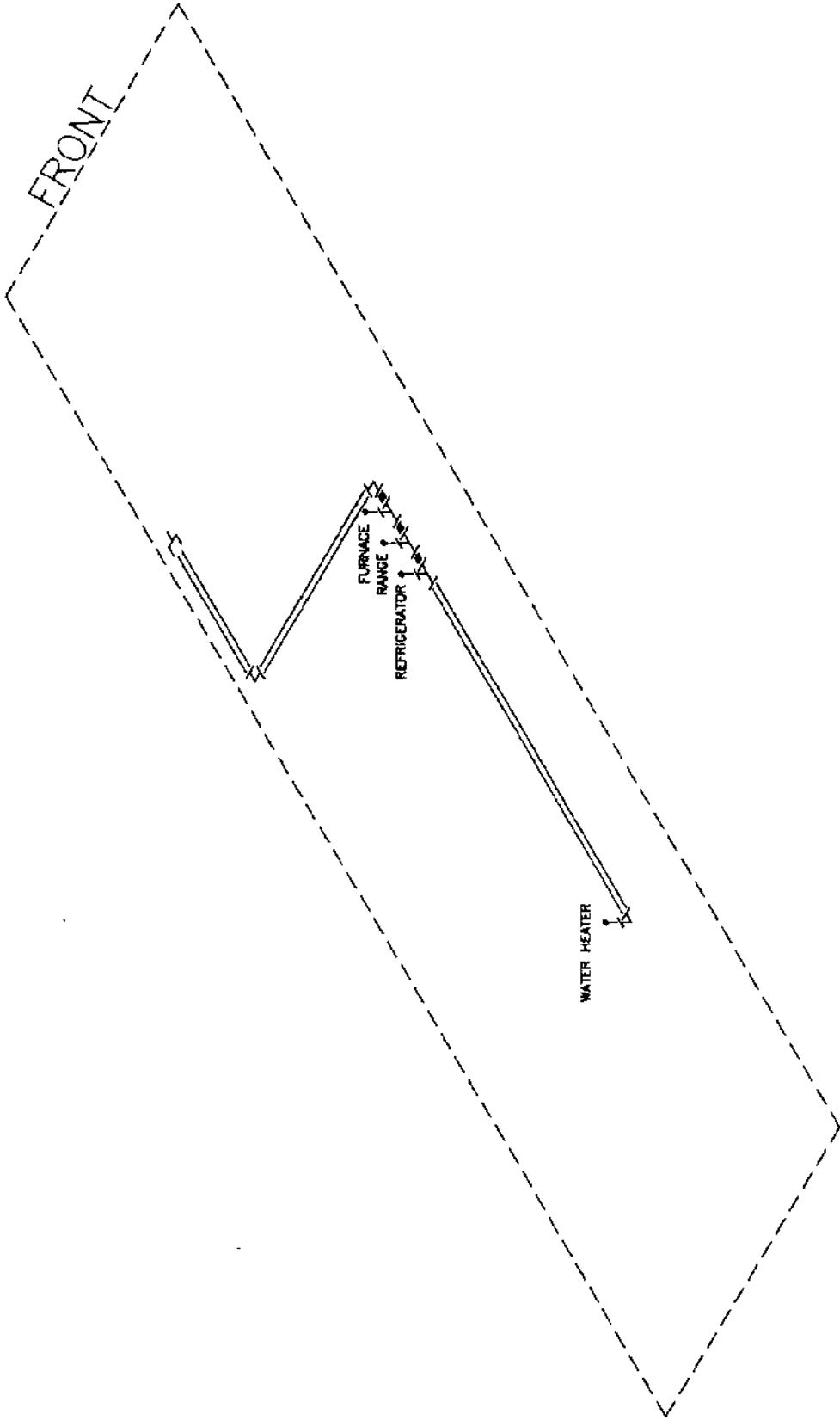

SINGLE MOUNT SLIDE OUT MOTOR INSTALLATION DIAGRAM

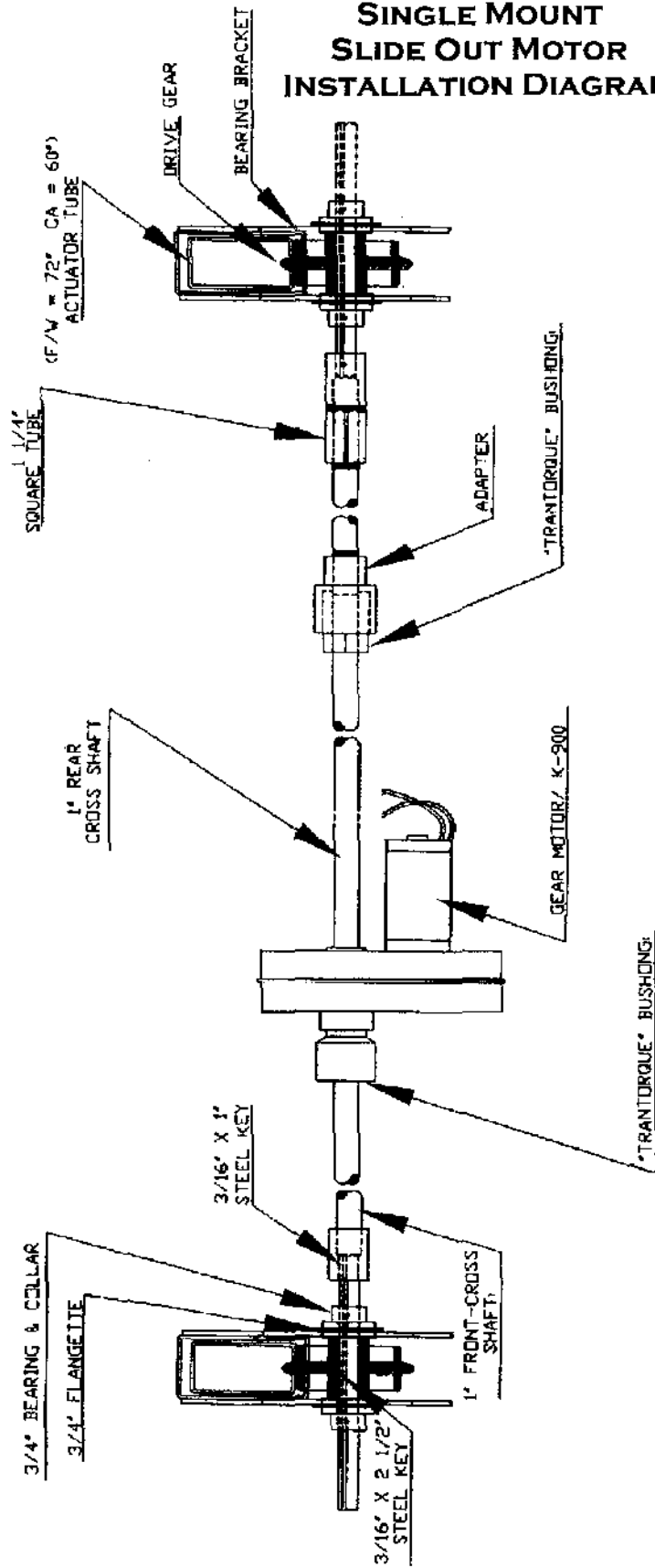

2000 KOUNTRY STAR CLASS A

DESCRIPTION	ITEM #
Antenna, CB	34783
Antenna, Cellular Phone	11570
Antenna, Radio	11571
Antenna, TV	11572
A/C	11573
Bumper, Front, Center	11574
Bumper, Rear	25334
Door, Entrance	30416
Door, Furnace	21868
Door, Refer Vent	11526
Door, Water Heater	31737
Faucet, Lav	22540
Faucet, Kitchen, Sgl Hdl	38901
Faucet, Shower	22541
Grab Handle, Acrylic, Door	16229
Grab Handle Ends, Chrome, Door	12316
Grill	29355
Hood	29169
Horn, Trumpet	15941
Ladder	17187
Light, Clearance, Amber	18684
Light, Clearance, Amber Side	37914
Light, Clearance, Red	20619
Light, Docking	13851
Light, Fog	29330
Light, Head, Left Side	22032

DESCRIPTION	ITEM #
Light, Head, Right Side	22031
Light, Scare	10674
Light, Spot	12300
Light, Tail, Back Up	30998
Light, Tail, Center	30997
Light, Tail, Wrap Around	30996
Mirror, Rear View	27352
Recept, 12 Volt, Brown	22281
Recept, 12 Volt, White	10641
Recept, 120 Volt	10551
Recept, GFCI	10553
Register, Floor	22580
Register, Floor, Ceiling	12292
Roof Rack	11820
Sink Cover - Large	41203
Sink Cover - Small	41275
Skylight	14607
Step, Bumper, Fold-A-Way	16169
Step, Kwikkee	37710
Switch, 12 Volt, Double	24810
Switch, 12 Volt, Single	24809
Switch, 12 Volt, Triple	24911
Switch, 120 Volt	10543
T-Stat, Dometic	27782
T-Stat, FanTastic Vent	01513
Windshield Gasket	27261
Windshield, Left Side	26315
Windshield, Right Side	26316