

2008

**X-AIRE  
FIFTH WHEEL**

BY NEWMAR



Welcome to the Newmar Family!

Welcome to the exciting world of recreational vehicle traveling and the growing Newmar family. Congratulations on your purchase of a Newmar product. We sincerely thank you for choosing Newmar as your recreational vehicle. We hope that you will enjoy many miles of traveling. Your new vehicle was built with care using today's technology and old world craftsmanship. We, at Newmar, strive to build vehicles that are safe, dependable, and comfortable to provide you with years of carefree, pleasant traveling.

Please read the Newmar Limited Warranty and all other component warranties that apply to the equipment installed on your unit. Carefully read both the instructions in this Owners Guide and the booklets supplied by the component manufacturers for important operation, safety, and maintenance requirements/information. Your dealer should be consulted should you have any questions. If your dealer is unable to answer the questions to your satisfaction he will refer you to our staff for assistance. Our customers are extremely important to us and we will make every effort necessary to ensure your satisfaction.

The limited warranties issued by component manufacturers require periodic service and maintenance. The owner's failure to provide this service and/or maintenance will result in the loss of warranty coverage. Be sure to file the appropriate registration card with the component manufacturer as described with the individual instruction booklets to activate the warranties on the components within your Newmar RV. This Owner's Guide should be kept in your vehicle for quick reference. Take time to get acquainted with your unit and how it operates. Again, thank you and welcome to the Newmar family.

Newmar Corporation

This guide, along with the Companion Video Owner's Guide, has been provided by Newmar Corporation solely for the purpose of providing instructions about the operation and maintenance of this vehicle and its components. Nothing in this manual creates any warranty, either expressed or implied. The only warranty offered by Newmar Corporation is set forth in the written limited warranty that applies to this vehicle.

Instructions are included in this manual for operating some of the components that are standard on this vehicle. Instructions are also given for components that are options and may not appear on all vehicles. For more detailed information on components refer to the individual manufacturers operating instructions contained in the Owner's Information Package.

The limited warranties issued by component manufacturers require periodic service and maintenance. The owner's failure to provide this service and/or maintenance will result in the loss of warranty coverage. The owner should review the Newmar Corporation limited warranty and other manufacturers limited warranties of all components applicable to this vehicle. To activate the warranties on the components within your Newmar recreational vehicle, be sure to file the appropriate registration card with the component manufacturer as described with the individual instruction booklet.

The Video Owner's Guide, that accompanies this printed Owners Guide, contains a wealth of information you will find useful as you enjoy your coach. When inserted into a DVD player, the "Main Menu" will allow you to navigate through the options and accessories until you find the exact information on your coach. For example, to obtain operating instructions on the specific refrigerator in your unit, from the "Main Menu" select the "Appliances" section. A menu of appliances will appear, from which you would select "Refrigerators". Once in the "Refrigerators" section, you will select the make and model your unit is equipped with. Video information for operating the accessory or appliance will follow.

Additional information is also contained on the DVD that can be accessed by your computer if equipped with a DVD ROM. Simply insert the DVD into your computer's DVD ROM drive, and select from the "Technical Service Information" menu, or the "Prints and Diagrams" menu. Under the "Prints and Diagrams" menu you will find a listing of the different brands and models Newmar manufactures. Select your brand and model, then select your specific floorplan from the list provided. When opened in this manner, floorplan

specific prints for your unit can be accessed and, if needed, printed off for your use. Adobe® Acrobat® Reader® is required to view the diagrams. Download the latest version free at [www.adobe.com](http://www.adobe.com).

Throughout this guide, reference is made to the following terms: Warning, Caution, and Important. These terms indicate important information that must be understood and followed. The definitions of these terms are:

<b>WARNING</b>
Emphasizes an area in which personal injury or even death could result from failure to follow instructions properly. Mechanical damage may also occur.

<b>CAUTION</b>
Failure to observe a caution can cause damage to the equipment or unit. Personal injury is unlikely.

<b>IMPORTANT</b>
This will provide additional information to make a step easier or clearer.

Chapter **1**

**SERVICE INFORMATION**

**CUSTOMER ASSISTANCE.....3**

**COMPONENT PART SUPPLIERS.....3**

    Accessories..... 3

    Air Conditioning..... 4

    Appliances ..... 4

    Exterior..... 4

    Heating..... 5

**TO OUR VALUED CUSTOMERS:.....6**



## CUSTOMER ASSISTANCE

Newmar Corporation ..... 1-800-731-8300

## COMPONENT PART SUPPLIERS

### Accessories

Back Up Monitor	Atlanta DTH ..... 770-451-9777
	A. S. A. Inc. .... 574-266-1886
	C.T.D ..... 800-777-4856
	Total Vision Products ..... 520-623-0790
Back Up Monitor (Panasonic)	Mito ..... 888-433-6486
CB Radio (Cobra)	Tri Star Distributing..... 800-456-3340
Computer TripTek	River Park, Inc. .... 800-442-7717
Furniture (Upholstered)	Flexsteel Industries ..... 563-556-7730
	International ..... 714-535-7272
Internet System (Trac-Net)	River Park, Inc. .... 800-442-7717
Navigation	Mito ..... 888-433-6486
Navigation (DVD)	C.T.D. .... 800-777-4856
Roof Vent	FanTastic Vent Corp..... 800-521-0298
	Ventline..... 574-848-4491
Security System	Nagy Fleet Net Inc ..... 574-262-4479
Stereo AM/FM	Odyssey..... 800-877-0521
	River Park, Inc. .... 800-442-7717
Stereo (Audiovox)	A. S. A. Inc. .... 574-266-1886
Stereo (Pioneer)	C.T.D. .... 800-777-4856
Stereo (Sony)	River Park, Inc. .... 800-442-7717
TV Antenna	The Winegard Co..... 800-288-8094
Television (Magnavox)	Midwest Sales ..... 574-287-3365
Television (RCA)	Tri Star Distributing..... 800-456-3340
Television (Sony)	River Park, Inc. .... 800-442-7717
Television (Panasonic)	Mito..... 888-433-6486
Satellite Dish	The Winegard Co. .... 800-288-8094

Satellite Dish (Datron)	A. S. A. Inc. ....	574-266-1886
Satellite Dish (KVH)	River Park, Inc. ....	800-442-7717
VCR (RCA)	Collins & Company .....	574-848-1118
VCR (Sony)	River Park, Inc. ....	800-442-7717

### Air Conditioning

Roof Air	Dometic.....	800-544-4881
----------	--------------	--------------

### Appliances

Dishwasher, 18" (Frigidaire)	Frank-lin Premiums .....	866-213-9397
Dishwasher, 24"	Midwest Sales .....	574-287-3365
Freezers	Norcold .....	800-543-1219
Ice Makers	U-Line.....	800-779-2547
Microwave (Dometic)	Dometic.....	800-544-4881
Microwave (GE)	TCL Enterprises.....	800-334-8251
Range	Atwood-Greenbrier .....	815-877-5700
	Magic Chef .....	515-792-7000
Refrigerator	Dometic.....	800-544-4881
	Norcold .....	800-543-1219
Water Heater	Atwood Mobile Prod. ....	815-877-5700
	Suburban Mfg. ....	800-659-2138
	Vehicle Systems.....	800-685-4298
Washer/Dryer, 1-piece	Splendide .....	800-736-4127
Washer/Dryer, 2-piece	Whirlpool.....	800-442-1111
Generators	Generac .....	800-747-1530
	Onan.....	800-888-6626
	Power Tech .....	800-760-0027
Inverters	Xantrex .....	800-446-6180

### Exterior

Awning & Hardware	A & E.....	800-544-4881
	Carefree of Colorado .....	800-621-2617
	Girard.....	800-382-8442
Axle & Components	Axle.....	574-295-1900



Hitch (CA & DP)	Hidden Hitch..... 877-869-6787
Jacks (CA & DP)	H W H Corporation ..... 800-494-3213
Jacks (FW & TT)	Atwood Mobile Prod. .... 815-877-5700
Rubber Suspension	Mor-Ryde, Inc..... 574-293-1581
Steps, Electrical (KS DP)	Fleming (SCS) ..... 800-275-7524
Steps, Electrical	Kwikee Products ..... 800-736-9961
Steps, Manual	Hickory Springs Mfg. .... 501-646-6161
	Elkhart Tool and Die ..... 574-295-8500
Tires	Goodyear..... 800-227-1999
	RFD Components ..... 574-295-3939

## Heating

Furnaces	Atwood Mobile Prod. .... 815-877-5700
	Suburban Mfg. .... 800-659-2138
Furnace, Aqua-Hot & Hydro-Hot	Vehicle Systems..... 800-685-4298

Please note that your Newmar Limited Warranty is activated only after Newmar has received a signed Warranty Registration Form from your selling dealer. If it has been more than 60 days since the purchase of your new coach and you have not received your Newmar Owner's Warranty Card, please contact your selling dealer or the Newmar Warranty Department at 800-731-8300.

## TO OUR VALUED CUSTOMERS:

If, for any reason, you have a problem obtaining satisfactory and timely warranty service that may substantially impair the use, value or safety of your Newmar product, please call us on our toll free line at 800-731-8300 so that we may attempt to resolve your concerns.

All of the information contained in this brochure is believed to be accurate at the time of publication. However, it may be necessary to make revisions and Newmar reserves the right to make any such changes without notice or obligation. Please refer to the component information literature provided in the Owner's Information Packet for specific warranty details for the components applicable to your recreational vehicle.



NEWMAR CORPORATION  
355 N DELAWARE ST  
PO BOX 30  
NAPPANEE, IN 46550-0030  
*www.newmarcorp.com*

Chapter **2**

**GENERAL & SAFETY INFORMATION**

Delivery ..... 3  
Dealer Responsibilities ..... 3  
Customer Responsibilities ..... 3  
Major Equipment Manufacturers ..... 4  
Recreational Vehicle Limited Warranty ..... 5  
Warranty Service ..... 6  
Owner’s Information Package ..... 6  
Reporting Safety Defects ..... 6  
Safety Precautions ..... 6  
Customer Relations ..... 7  
Information Sheet ..... 7

**RECOMMENDED SERVICE CENTER LISTINGS**

**IMPORTANT RV TIRE INFORMATION.....20**

**SAFETY PRECAUTIONS.....21**

Towing ..... 21  
Propane Gas ..... 21  
Propane Gas System General Information ..... 21  
Propane Regulator ..... 23  
Propane Distribution Lines ..... 23  
Precautions & Recommendations ..... 23  
Fire Safety ..... 24  
Fire Extinguishers ..... 24  
Smoke Detector ..... 25  
Emergency Exit Window ..... 25  
Weight Information ..... 25  
Weighing the Unit ..... 25  
Hitching Fifth Wheels ..... 27  
Campsite Parking ..... 28

**SECOND OWNER INFORMATION .....30**





## DELIVERY

Throughout the manufacturing process, your vehicle has been inspected by our qualified technicians. However, our final inspection at the factory is not to be the last one. The pre-delivery inspection and systems check your dealer performs are the final inspections done to the unit prior to you receiving your new coach. Your dealer is also available to assist you in understanding the limited warranties and completing any necessary forms to activate the warranties for the various appliances and accessories installed in your unit.

### Dealer Responsibilities

1. A pre-delivery inspection and systems check. Thoroughly inspecting the vehicle and the operation of the factory installed components.
2. A customer walk through. This is done to familiarize the customer with the vehicle, its systems and components, and their operation.
3. Delivery of the Owner's Information Package. This package contains the warranty cards and registrations for the vehicle and factory installed components that carry a separate warranty. The detailed operating and maintenance instructions on these components are also included in this package.
4. Assisting the customer in completing the component registration forms, at the customer's request. To avoid loss of warranty coverage, the dealer should review the limited warranty provisions with the customer stressing the importance of filing warranty cards and registrations to the component manufacturers within the prescribed time limit.
5. Providing the customer with information regarding warranty and non-warranty work on the vehicle and its separately warranted components whether the customer is in or out of the area.

### Customer Responsibilities

The customer is responsible for regular and proper maintenance of the vehicle. Properly maintaining your vehicle will prevent conditions arising from neglect that are not covered by your Newmar limited warranty. The maintenance guidelines in this manual and any other applicable manual should be followed. It is your responsibility and obligation to return the vehicle to an authorized dealer for repairs and service.

To assist you in avoiding problems with your vehicle, we recommend you do the following:

- A. Read the warranty.** Go over it thoroughly with your dealer.
- B. Inspect the vehicle.** Do not accept delivery until you have gone through the unit with the dealer. Newmar has provided a check list to be used during retail delivery. Check each item on the list and make sure the dealer does the same. Do not sign this checklist until you have done this.  
**NOTE: The sales literature versus actual specifics to the vehicle's measurements, weights, or quantities may vary.**
- C. Ask questions** about anything that you do not understand concerning your recreational vehicle.
- D. When taking delivery,** set an appointment for adjustments. This appointment should be approximately two (2) weeks after you accept delivery.
- E. Responsible Use.** Your vehicle is designed to be used for recreational or temporary living purposes. It is not designed to be used as a full-time residence or for commercial use. Commercial use means using as a business asset such as a mobile office or using the vehicle for lease/rental purposes.

### Major Equipment Manufacturers

A & E Awnings .....	800-544-4881
Atlanta DTH, Inc. ....	770-451-9777
Atwood Mobile Product .....	815-877-5700
A.S.A. Inc. ....	574-266-1886
Carefree of Colorado .....	800-621-2617
Collins & Company.....	574-848-1118
Dexter Axle .....	574-295-1900
Dometic, Duo Therm.....	800-544-4881
Elkhart Tool & Die.....	574-295-8500
Evans Tempcon .....	800-354-7088
FanTastic Vent Corp. ....	800-521-0298
Flexsteel Industries.....	563-556-7730
Ford Motor Company .....	800-444-3311
Freightliner Custom Chassis .....	800-FTL-HEPropane
Gekotek Electronics (Monitor Panel).....	714-738-3551
Generac Generators .....	800-747-1530
Goodyear Tires .....	800-227-1999
HWH Corporation .....	800-494-3213
Hickory Springs Mfg.....	501-646-6161
Hidden Hitch .....	877-869-6787

IOTA .....	877-682-4682
Interstate Batteries - 12 Volt.....	800-872-4100
Interstate Batteries - 6 Volt.....	888-772-3600
KVH Industries .....	401-847-3327
Kwikkee Products .....	800-736-9961
Magic Chef.....	515-792-7000
Midwest Sales & Service.....	574-287-3365
Mito .....	888-433-6486
Mor-Ryde, Inc. ....	574-293-1581
Nagy Fleet Net, Inc. ....	574-262-4479
Norcold .....	800-543-1219
Onan Generators.....	800-888-6626
Pioneer.....	800-777-4856
PowerTech Generators .....	800-760-0027
Putnam Hitch.....	517-369-2165
Quest Corp.....	800-877-0521
RFD Components .....	574-295-3939
Scope Seating .....	574-295-6016
SeaLand Technology.....	800-321-9889
Sears .....	800-359-2000
Sony.....	800-222-7669
Spartan Motors .....	800-543-4277
Splendide Washer/Dryer .....	800-736-4127
Suburban Mfg.....	423-775-2131
Thetford Toilet .....	800-521-3032
U-Line Ice Maker .....	800-779-2547
Villa International.....	714-535-7272
Vehicle Systems .....	800-685-4298
Ventline (Range Hood) .....	574-848-4491
Winegard Antenna Systems .....	800-288-8094
Workhorse Custom Chassis.....	877-946-7731
Xantrex .....	800-446-6180

### Recreational Vehicle Limited Warranty

The Newmar Corporation Limited Warranty was provided to you by your selling dealer prior to purchase. Please refer to this document when inquiring about the Newmar Warranty. To receive an additional copy, please write to:

Newmar Corporation,  
Warranty Department,  
P.O. Box 30,  
Nappanee, IN 46550-0030.

## Warranty Service

Warranty service required needs to be completed during the term of the warranty. Service work performed after the expiration of the Newmar 12 month warranty **WILL NOT** be covered by the warranty.

## Owner's Information Package

Included in this package are valuable documents about your vehicle and its components and systems. The Newmar Owner's Guide does not cover every possible detail of equipment, standard and/or option, installed on or in your vehicle. Consulting the booklets and instruction manuals in this package will help you safely operate, maintain, and troubleshoot these items. Read all of the information and understand the safety and operating instructions included in the Owner's Information Package. To assure full warranty coverage, it is essential that all maintenance instructions are followed.

## Reporting Safety Defects

If you believe that your vehicle has a significant defect which could cause a crash or could cause injury or death, you should inform the National Highway Traffic Safety Administration (NHTSA) and Newmar Corporation.

To contact NHTSA, you may either call the Auto Safety Hotline toll free at 1-888-327-4236 (TTY #1-800-424-9153) or write to: NHTSA, 400 Seventh Street, S.W., Washington, DC 20590. NHTSA also has established a website where you can contact them:

<http://www.safercar.gov>

## Safety Precautions

Read and understand all of the instructions and precautions in this owner's guide before towing your new travel trailer or fifth wheel. Listed below are some safety precautions that must be adhered to while your vehicle is in motion. These precautions, as well as others that involve possible damage to equipment, are also listed in the appropriate areas in this manual.





## Customer Relations

If you wish to schedule maintenance work, schedule service work, or to order parts you should notify your local authorized Newmar Service Center to set up an appointment. If you are unsure of the location of your closest Authorized Newmar Service Center, see the listing in the manual. You may also write to:

Newmar Corporation  
 Warranty Department  
 72185 C.R. 3  
 P.O. Box 30  
 Nappanee, IN 46550-0030

## Information Sheet

There are two main numbers used to identify the vehicle. The Vehicle Identification Number (VIN) is the legal identification of the completed vehicle. The VIN is the number used by the state for vehicle registration. The Newmar Serial Number is a six-digit number that is needed whenever making an appointment for service or ordering parts through your Newmar Dealer or Service Center. This number can be found on the placard in the wardrobe closet wall and on the Customer Care card received from Newmar.

Below is a sample of the Information Sheet.

1. The Newmar Serial Number
2. Year/Brand/Type/Floorplan
3. Vehicle Identification Number (VIN)
4. Manufacturer, Model and Serial Number of factory installed equipment.

THANK YOU FOR PURCHASING A QUALITY NEWMAR PRODUCT! FOR YOUR CONVENIENCE, WE HAVE ENCLOSED A SERIAL NUMBER LIST OF IMPORTANT EQUIPMENT INSTALLED IN YOUR 2005XXXXX###. THE SERIAL NUMBER FOR YOUR UNIT IS ##XXXX##.

VIN# XXXXXXXXXXXXXXXXX		DECOR# XX5-###	WOODCOLOR CHERRY	
<b>CLIMATE SYSTEM</b>		<b>SERIAL #</b>		<b>AWNING</b>
FRONT A/C	630515.521	33267	INVERTER	RV2012M 0082072
CENTER A/C	630515.521	33268	CONVERTER	
REAR A/C			GENERATOR	042702 20570
DASH A/C	RV200975	8534	<b>AUDIO/VIDEO/NAVIGATION</b>	
FRONT FURN	SF42	05903	FRONT TV	24FV300 65575
REAR FURN			REAR TV	20F5100 72234
ALC/HEATER			TV #3	
<b>APPLIANCE</b>			EXT. TV	4381270 8101
RV	W02	41	FRIDGE	30F18C
				30Y055

# RECOMMENDED SERVICE CENTER LISTING

## ALABAMA

**MADISON RV CENTER**  
1707 JORDAN LANE N.W.  
HUNTSVILLE AL 35816  
Phone (256) 837-3881  
Fax (256) 830-4451

**MILLICAN RV AMERICA**  
36115 US HWY. 280  
SYLACAUGA AL 35150  
Phone (256) 249-3773  
Fax (256) 249-3958

## ALASKA

**A & M RV CENTER -**  
2225 E. 5TH AVE.  
ANCHORAGE AK 99501  
Phone (907) 279-5508  
Fax (907) 272-4156

**KAREN'S RV SERVICE CENTER**  
1850 VIKING DRIVE  
ANCHORAGE AK 99501  
Phone (907) 336-2055  
Fax (907) 336-2054

## ARIZONA

**BEAUDRY RV COMPANY**  
3200 EAST IRVINGTON RD.  
TUCSON AZ 85714  
Phone (520) 889-6000  
Fax (520) 294-0201

**ED HANNON RV CENTER**  
3735 E. IRVINGTON ROAD  
TUCSON AZ 85714  
Phone (520) 750-1100  
Fax (520) 750-0100

**MOHAVE RV REPAIR**  
4144 S. HWY. 95, STE. B  
FORT MOHAVE AZ 86426  
Phone (928) 704-1900  
Fax (928) 704-1926

**ROBERT CRIST RV**  
2025 E. MAIN STREET  
MESA AZ 85213  
Phone (480) 834-9410  
Fax (480) 834-8238

**RV PEDDLER**  
4710 E. HWY. 80  
YUMA AZ 85365

Phone (928) 344-0005  
Fax (928) 317-0540

**STAR VALLEY RV**  
255248 E. HWY. 260  
PAYSON AZ 85541  
Phone (928) 468-2363  
Fax (928) 468-8073

**SUN CITY RV INC.**  
9045 NORTHWEST GRAND AVE.  
PEORIA AZ 85345  
Phone (623) 979-8585  
Fax (623) 979-7121

## ARKANSAS

**OUTDOOR LIVING CENTER**  
HWY. 7 SOUTH  
P.O. BOX 1081  
RUSSELLVILLE AR 72801  
Phone (479) 968-7706  
Fax (479) 968-4360

## CALIFORNIA

**ALPINE RECREATION SLS & SVC**  
19380 MONTEREY ROAD  
MORGAN HILL CA 95037  
Phone (408) 779-4511  
Fax (408) 779-0754

**DAVE ALTMANS RV**  
1201 BALDWIN PARK BLVD.  
BALDWIN PARK CA 9170  
Phone (626) 960-1884  
Fax (626) 962-6906

**DAVE ALTMANS RV**  
22020 RECREATION ROAD  
CARSON CA 90745  
Phone (310) 518-6182  
Fax (310) 513-0497

**DAVE ALTMANS RV**  
1313 RV CENTER DRIVE  
COLTON CA 92324  
Phone (909) 422-0311  
Fax (909) 422-0450

**EL MONTE RENT'S INC.**  
12818 FIRESTONE BLVD.  
SANTA FE SPRINGS CA 90670  
Phone (562) 404-9300  
Fax (562) 404-4065  
Fax (562) 404-4065

**HAPPY DAZE RV**

1199 EL CAMINO AVE.  
SACRAMENTO CA 95815  
Phone (916) 920-8255  
Fax (916) 920-5503

**MANTECA TRAILER & CAMPER**

1990 E. YOSEMITE AVE.  
MANTECA CA 95336  
Phone (209) 239-1267  
Fax (209) 239-4348

**PAUL EVERT'S RV COUNTRY**

3633 S. MAPLE  
FRESNO CA 93725  
Phone (559) 486-1000  
Fax (559) 237-3298

**GIANT RV**

1300 E. SANTO ANTONIO DR.  
COLTON CA 92324  
Phone (909) 514-0444  
Fax (909) 872-1859

**GIANT RV**

2200 W. FRONTAGE ROAD  
CORONA CA 92882  
Phone (951) 371-0444  
Fax (951) 371-5377

**GIANT RV**

6441 BURT ROAD  
IRVINE CA 92618  
Phone (949) 681-0707  
Fax (949) 681-0444

**GIANT RV**

8646 SEPULVEDA BLVD.  
NORTH HILLS CA 91343  
Phone (818) 891-0786  
Fax (818) 895-1189

**GIANT RV**

9150 BENSON AVE.  
MONTCLAIR CA 91763  
Phone (909) 981-0444  
Fax (909) 608-0654

**GIANT RV**

24700 MADISON AVE.  
MURRIETA CA 92562  
Phone (951) 696-7444  
Fax (951) 696-7054

**GIANT RV**

77-840 VARNER ROAD  
PALM DESERT CA 92211  
Phone (760) 360-0491  
Fax (760) 360-1413

**HAPPY DAZE RV**

1199 EL CAMINO AVE.  
SACRAMENTO CA 95815

Phone (916) 920-8255  
Fax (916) 920-5503

**HOLLAND MOTOR HOMES**

7490 COPLEY PARK PLACE  
SAN DIEGO CA 92111  
Phone (858) 874-4444  
Fax (858) 874-8484

**MANTECA TRAILER & CAMPER**

1990 E. YOSEMITE AVE.  
MANTECA CA 95336  
Phone (209) 239-1267  
Fax (209) 239-4348

**McMAHON'S RV**

6441 BURT ROAD #10  
IRVINE CA 92618  
Phone (949) 653-6711  
Fax (949) 653-6713

**PAUL EVERT'S RV COUNTRY**

3633 S. MAPLE  
FRESNO CA 93725  
Phone (559) 486-1000  
Fax (559) 237-3298

**RV PEDDLER**

8730 GOLDEN STATE HWY.  
BAKERSFIELD CA 93308  
Phone (661) 392-7400  
Fax (661) 399-9408

**TEMECULA VALLEY RV**

28897 FRONT STREET  
TEMECULA CA 92590  
Phone (951) 695-1018  
Fax (951) 308-1935

**COLORADO**

**ALL STARS RV REPAIR**

5989 W. LOUVIERS ST.  
LOUVIERS CO 80131  
Phone (720) 348-0404  
Fax (720) 348-0712

**CENTURY RV INC.**

4000 N. VALLEY DRIVE  
LONGMONT CO 80504  
Phone (970) 535-6300  
Fax (970) 535-9992

**J D L TRAILER SALES**

2734 LAKE AVENUE  
PUEBLO CO 81004  
Phone (719) 564-8056  
Fax (719) 564-0306

**MOUNTAIN STATES RV**  
14300 E. COLFAX AVENUE  
AURORA CO 80011  
Phone (303) 360-0252  
Fax (303) 365-9297

**PIKE'S PEAK TRAVELAND**  
4815 E. PLATTE AVE.  
COLORADO SPRINGS CO 80915  
Phone (719) 596-2716  
Fax (719) 622-1716

## CONNECTICUT

**DAVE'S RV CENTER**  
2 INDUSTRIAL PLAZA ROAD  
DANBURY CT 06810  
Phone (203) 730-1744  
Fax (203) 730-1741

## DELAWARE

**PARKVIEW RV CENTER**  
5511 DUPONT PARKWAY  
SMYRNA DE 19977  
Phone (302) 653-6619  
Fax (302) 653-6631

**SLICERS CAMPING TRAILERS**  
773 S. DUPONT HWY.  
NEW CASTLE DE 19720  
Phone (302) 836-4110  
Fax (302) 836-4781

## FLORIDA

**DICK GORE'S RV WORLD**  
14590 DUVAL PLACE WEST  
JACKSONVILLE FL 32218  
Phone (904) 741-5100  
Fax (904) 741-4905

**FREIGHTLINER OF SO. FLORIDA**  
1699 N. US 1  
FORT PIERCE FL 34950  
Phone (772) 466-9424  
Fax (772) 466-5102

**HARBERSON SWANSTON LLC**  
17028 US HWY. 19 NORTH  
CLEARWATER FL 33764  
Phone (727) 539-8714  
Fax (727) 539-1714

**HARBERSON SWANSTON LLC**  
2112 US 19 NORTH  
HOLIDAY FL 34691  
Phone (727) 937-6176  
Fax (727) 942-7691

**INDEPENDENCE RV**  
12705 W. COLONIAL DRIVE  
WINTER GARDEN FL 34787  
Phone (407) 877-7878  
Fax (407) 877-3806

**INDIAN RIVER RV INC.**  
1698 N. CENTRAL AVE.  
SEBASTIAN FL 32958  
Phone (772) 581-1677  
Fax (772) 581-3590

**INTERNATIONAL RV WORLD**  
25199 HWY. 27  
LAKE WALES FL 33859  
Phone (863) 439-2977  
Fax (863) 439-2978

**LAND YACHTS**  
1414 COMMERCE LANE  
P.O. BOX 1840  
JUPITER FL 33468  
Phone (561) 745-0242  
Fax (561) 745-1725

**LEISURE TYME RV**  
1490 HWY. 98 WEST  
MARY ESTHER FL 32569  
Phone (850) 581-0880  
Fax (850) 581-2300

**LEISURE TYME RV**  
6428 PENSACOLA BLVD.  
PENSACOLA FL 32505  
Phone (850) 476-6848  
Fax (850) 474-6392

**NORTH TRAIL RV CENTER**  
5270 ORANGE RIVER BLVD.  
FORT MYERS FL 33905  
Phone (239) 693-8200  
Fax (239) 693-0141  
[www.northtrailrv.com](http://www.northtrailrv.com)

**TRAVEL EASY SALES & SERVICE**  
4299 HWY. 441 SOUTH  
OKEECHOBEE FL 34974  
Phone (863) 467-0400  
Fax (863) 467-9396  
[www.traveleasyrv.com](http://www.traveleasyrv.com)

## GEORGIA

**DICK GORE'S RV WORLD INC.**  
250 LONGWOOD DRIVE  
RICHMOND HILL GA 31324  
Phone (912) 756-6606  
Fax (912) 756-6627  
[www.dickgoresrvworld.com](http://www.dickgoresrvworld.com)

**SAGON MOTORHOMES**  
172 VAN MAR BLVD.  
JACKSON GA 30233  
Phone (678) 752-0009  
Fax (678) 752-9966

## IDAHO

**BODILY RV II, INC.**  
4409 CHINDEN BLVD.  
GARDEN CITY ID 83714  
Phone (208) 376-7029  
Fax (208) 376-7204

## ILLINOIS

**COLLIER RV CENTER**  
7373 HARRISON AVE.  
ROCKFORD IL 61112  
Phone (815) 332-3322  
Fax (815) 332-8388

**EHRHARDT'S TRAILER SALES**  
776 W. OAKTON ST.  
DES PLAINES IL 60018  
Phone (847) 437-3421  
Fax (847) 437-3459

**LARRY'S TRAILER SALES**  
HWY. 148 NORTH  
ZEIGLER IL 62999  
Phone (618) 596-6414  
Fax (618) 596-6344

**R & S SALES & SERVICE**  
218 S. LAKE OF THE WOODS  
MAHOMET IL 61853  
Phone (217) 586-2055  
Fax (217) 586-2382  
[www.rsrvsales.com](http://www.rsrvsales.com)

**BROWN & BROWN**  
1400 LOCKE DRIVE  
BRADLEY IL 60915  
Phone (815) 933-2251  
Fax (815) 933-9710

## INDIANA

**BASDEN'S AMERICAN RV**  
600 E. BASELINE ROAD  
EVANSVILLE IN 47735  
Phone (812) 867-5200  
Fax (812) 867-4398

**DON'S CAMPER SALES**  
U.S. 41 S. BOX 373  
BOSWELL IN 47921  
Phone (765) 869-5009

Fax (765) 869-5009

**HART CITY RV CENTER LLC**  
2300 S. NAPPANEE STREET  
ELKHART IN 46517  
Phone (574) 295-5793  
Fax (574) 295-6190

**INDY RV CENTER**  
457 KNIGHT DR.  
GREENWOOD IN 46142  
Phone (317) 881-0300  
Fax (317) 881-0431

**INTERNATIONAL RV WORLD**  
2300 S. NAPPANEE STREET  
ELKHART IN 46517  
Phone (574) 293-8878  
Fax (574) 293-6517

**PREMIER RV INC.**  
1400 LEISURE WAY  
CLARKSVILLE IN 47129  
Phone (812) 284-1400  
Fax (812) 283-3465

**TOM STINNETT HOLIDAY RV**  
520 MARRIOTT DRIVE  
CLARKSVILLE IN 47129  
Phone (812) 282-7718  
Fax (812) 285-7578

**WALNUT RIDGE TRAILER SALES**  
87 N. CR 300 WEST  
NEW CASTLE IN 47362  
Phone (765) 533-2288  
Fax (765) 533-2312

**WETNIGHT RV SLS & SERVICE**  
4401 US 41 NORTH  
TERRE HAUTE IN 47805  
Phone (812) 466-3961  
Fax (812) 466-6851

## IOWA

**AUTORAMA RV CENTER**  
2227 SE 14TH  
DES MOINES IA 50320  
Phone (515) 282-0443  
Fax (515) 282-1425

**CHEYENNE CAMPING CENTER**  
2960 PLAINVIEW ROAD  
WALCOTT, IA 52773  
Phone (563) 284-6868  
Fax (563) 284-6890

**HEROLD TRAILER SALES**

1806 W. 2ND AVE., HWY. 92 WEST  
 INDIANOLA IA 50125  
 Phone (515) 961-7405  
 Fax (515) 961-7919

**WALKER TRAILER SALES INC.**

HWY. 122 WEST, BOX 633  
 NORA SPRINGS IA 50458  
 Phone (641) 749-2321  
 Fax (641) 749-2379

**KANSAS****A & R**

16685 ORCHARD LANE  
 STILWELL KS 66085  
 Phone (913) 681-5446  
 Fax (913) 681-5446

**HARPER CAMPERLAND**

1200 E. 10TH  
 GREAT BEND KS 67530  
 Phone (620) 792-5170  
 Fax (620) 792-8466

**HARPER CAMPERLAND**

117 W. 14TH  
 HARPER KS 67058  
 Phone (620) 896-2862  
 Fax (620) 896-2858  
[www.harpercamperland.com](http://www.harpercamperland.com)

**JAYHAWK CAMPER SALES**

24105 W. 43RD  
 SHAWNEE KS 66226  
 Phone (913) 422-5677  
 Fax (913) 422-7147

**KENTUCKY****BLUEGRASS RV**

1675 NORTH BROADWAY  
 LEXINGTON KY 40505  
 Phone (859) 253-1777  
 Fax (859) 231-9369

**SUMMIT RV SALES INC.**

6917 US 60  
 ASHLAND, KY 41102  
 Phone (606) 928-6795  
 Fax (606) 928-2340

**YOUNGBLOOD RV CENTER INC.**

2132 STATE ROUTE #45 NORTH  
 MAYFIELD KY 42066  
 Phone (270) 247-8591  
 Fax (270) 247-0604

**LOUISIANA****DIXIE RV SUPERSTORES**

10241 DESTINATION DRIVE  
 HAMMOND LA 70403  
 Phone (225) 567-4424  
 Fax (225) 567-4473

**MILLER RV**

12912 FLORIDA BLVD.  
 BATON ROUGE LA 70815  
 Phone (225) 275-2940  
 Fax (225) 275-6807

**SOUTHERN RV INC.**

3625 INDUSTRIAL DRIVE  
 BOSSIER CITY LA 71112  
 Phone (318) 746-2267  
 Fax (318) 746-2227

**MAINE****MOUNTAIN ROAD RV**

31 MOUNTAIN ROAD  
 SABATTUS ME 04280  
 Phone (207) 375-4091  
 Fax (207) 375-4014

**MARYLAND****BECKLEY'S CAMPING CENTER**

11109 ANGLEBERGER ROAD  
 THURMONT MD 21788  
 Phone (301) 898-3300  
 Fax (301) 898-1017

**MASSACHUSETTS****BOB'S CAMPER & RV**

2810 HANCOCK ROAD  
 WILLIAMSTOWN MA 01267  
 Phone (413) 458-3093  
 Fax (413) 458-9837

**STEARNS RV SALES**

71 MECHANIC ST.  
 BELLINGHAM MA 02019  
 Phone (508) 966-1220  
 Fax (508) 966-3408

**MICHIGAN****BEECH GROVE TRAILER SALES**

51439 M 40 NORTH  
 MARCELLUS MI 49067  
 Phone (269) 646-7845  
 Fax (269) 646-2012

**GENERAL TRAILER SALES**

12410 DIXIE HWY.  
 BIRCH RUN MI 48415  
 Phone (989) 624-7000

**GENERAL TRAILER SALES**

17277 RACHO ROAD  
BROWNSTOWN TWP MI 48192  
Phone (734) 284-5500  
Fax (734) 284-5568

**GENERAL TRAILER SALES**

24583 N. RIVER ROAD  
MT. CLEMENS MI 48043  
Phone (586) 954-3600  
Fax (586) 954-0182

**GENERAL TRAILER SALES**

5300 HIGHLAND ROAD  
WATERFORD MI 48327  
Phone (248) 674-0346  
Fax (248) 674-3809

**GENERAL TRAILER SALES**

476 RENO DRIVE  
WAYLAND MI 49348  
Phone (269) 792-9118  
Fax (269) 792-6210

**GENERAL TRAILER SALES**

48500 12 MILE ROAD  
WIXOM MI 48393  
Phone (248) 349-0900  
Fax (248) 349-7965

**HILLTOP RV SUPERSTORE**

2905 N. LINCOLN ROAD  
ESCANABA MI 49829  
Phone (906) 786-7986  
Fax (906) 786-3421

**INTERNATIONAL RV WORLD**

2717 E. DELTA ROAD  
BAY CITY MI 48706  
Phone (989) 667-9840  
Fax (989) 667-9843

**KITSMILLER RV**

1211 N. CEDAR  
MASON MI 48854  
Phone (517) 694-7500  
Fax (517) 694-3542

**MIDWAY MOTOR HOMES**

5590 S. DIVISION AVE.  
GRAND RAPIDS MI 49548  
Phone (616) 534-9641  
Fax (616) 534-6869

**MODERN TRAILER SALES**

7834 S. DIVISION AVE.  
GRAND RAPIDS MI 49548-2110  
Phone (616) 281-3010  
Fax (616) 281-3449

**MINNESOTA****OAK LAKE CAMPGROUND**

52777 HOFFMAN DRIVE  
KERRICK, MN 55756  
Phone (218) 496-5678  
Fax (218) 496-5678

**STEINBRING MOTORCOACH**

3710 S. HWY. 29  
ALEXANDRIA MN 56308  
Phone (320) 762-2114  
Fax (320) 762-8375

**STENZEL'S CAMPERS**

4701 HWY. 169  
ELMORE MN 56027  
Phone (641) 948-3204  
Fax (641) 948-3205

**MISSISSIPPI****AMERICAN RV CENTERS, INC.**

8150 CRAFT ROAD  
OLIVE BRANCH MS 38654  
Phone (662) 893-3040  
Fax (662) 893-3044

**RV REPAIR & SALES**

4749 HWY. 80 WEST  
JACKSON MS 39209  
Phone (601) 922-9425  
Fax (601) 922-5153

**RV REPAIR & SALES**

4749 HWY. 80 WEST  
JACKSON MS 39209  
Phone (601) 922-9425  
Fax (601) 922-5153

**MISSOURI****BEN'S RECREATIONAL VEHICLES**

RT. B BOX 167  
CANTON MO 63435  
Phone (573) 288-3287  
Fax (573) 288-3287

**CAPETOWN R V SALES**

I 55 & AIRPORT ROAD  
CAPE GIRARDEAU MO 63702  
Phone (573) 334-7152  
Fax (573) 334-9059

**COACHLIGHT RV SALES**

5327 S. GARRISON AVE.  
CARTHAGE MO 64836  
Phone (417) 358-7444  
Fax (417) 358-0856

**FRANK REED RV**  
HWY. 47 NORTH  
ST. CLAIR MO 63077  
Phone (636) 583-2244  
Fax (636) 583-2147

**K C TRAILER SALES**  
11520 S. 71 HWY.  
KANSAS CITY MO 64137  
Phone (816) 761-1393  
Fax (816) 761-7722

## **MONTANA**

**BOZEMAN MOTORS INC.**  
2900 N. 19TH AVE.  
BOZEMAN MT 59718  
Phone (406) 587-1221  
Fax (406) 586-1400

**BRETZ RV & MARINE**  
RESERVE STREET AT I-90  
4800 GRANT CREEK ROAD  
MISSOULA MT 59808  
Phone (406) 541-4800  
Fax (406) 541-4813

## **MONTANA**

**BOZEMAN MOTORS INC.**  
2900 N. 19<sup>TH</sup> AVE.  
BOZEMAN MT 59718  
Phone (406) 587-1221  
Fax (406) 586-1400

**BRETZ RV & MARINE**  
RESERVE STREET AT I-90  
4800 GRANT CREEK ROAD  
MISSOULA MT 59808  
Phone (406) 541-4800  
Fax (406) 541-4813

## **NEBRASKA**

**RICH & SONS CAMPER SALES**  
5112 S. ANTELOPE DRIVE  
GRAND ISLAND NE 68803  
Phone (308) 384-2040  
Fax (308) 384-2043

## **NEVADA**

**WHEELERS LAS VEGAS RV**  
13175 LAS VEGAS BLVD. SOUTH  
LAS VEGAS NV 89044  
Phone (702) 896-9000  
Fax (702) 896-4504

## **NEW HAMPSHIRE**

**C.H. DANA RV INC.**  
628 WOODSVILLE RD.  
MONROE NH 03771-3328  
Phone (603) 638-2200  
Fax (603) 638-2066

**CAMPERS INN OF KINGSTON**  
146 ROUTE 125  
KINGSTON NH 03848  
Phone (603) 642-5555  
Fax (603) 642-9931

**MOUNTAIN VALLEY RECREATION**  
410 MAIN STREET  
GORHAM NH 03581  
Phone (603) 466-3868  
Fax (603) 466-2416

## **NEW JERSEY**

**SCOTT MOTOR COACH SALES**  
1133 ROUTE 88  
LAKEWOOD NJ 08701  
Phone (732) 370-1022  
Fax (732) 905-1010

**WHITE HORSE LEISURE INC.**  
980 N. BLACK HORSE PIKE  
WILLIAMSTOWN NJ 08094  
Phone (856) 262-1717  
Fax (856) 629-8177

## **NEW MEXICO**

**AMERICAN HOLIDAY RV**  
9999 CENTRAL N.E.  
ALBUQUERQUE NM 87123  
Phone (505) 299-6838  
Fax (505) 296-0251

**AMERICAN RV CENTERS, LLC**  
11810 CENTRAL S.E.  
ALBUQUERQUE NM 87123  
Phone (505) 293-1983  
Fax (505) 293-6991

## **NEW YORK**

**ALL AMERICAN RV/BARRETT**  
674 QUAKER ROAD  
QUEENSBURY NY 12804  
Phone (518) 793-5212  
Fax (518) 792-1988

**ALPIN HAUS SKI SHOP INC.**  
1863 ROUTE 5S  
AMSTERDAM NY 12010  
Phone (518) 843-4400  
Fax (518) 843-5159



**ALPIN HAUS SKI SHOP INC.**  
103 SITTERLY ROAD  
CLIFTON PARK NY 12065  
Phone (518) 371-2211  
Fax (518) 373-5930

**BALLARDS CAMPING CENTER**  
S - 5849 SOUTHWESTERN BLVD.  
HAMBURG NY 14075  
Phone (716) 649-9654  
Fax (716) 648-0340

**JOURNEYTIME TRAILERS INC.**  
940 MIDDLE COUNTRY ROAD  
SELDEN NY 11784  
Phone (631) 698-0055  
Fax (631) 736-6622

**SEVEN O'S**  
7917 DEVAUL ROAD  
KIRKVILLE NY 13082  
Phone (315) 687-9342  
Fax (315) 687-7992

**WES TRAILER SALES**  
6166 ROUTE 25  
WADING RIVER NY 11792  
Phone (631) 727-5852  
Fax (631) 727-5396

**WILKINS RV INC.**  
1099 ALMOND ROAD  
HORNELL NY 14843  
Phone (607) 324-1313  
Fax (607) 281-1037

**WRATTEN TRAILER SALES LLC**  
9209 ROUTE 11 SOUTH  
ADAMS NY 13605  
Phone (315) 232-4535  
Fax (315) 232-3445

## **NORTH CAROLINA**

**HOWARD RV CENTER**  
6811 MARKET STREET  
WILMINGTON NC 28405  
Phone (910) 791-5371  
Fax (910) 392-0672

**OLD TOWN CAMPER SALES**  
5109 NORTH CAUSEWAY DRIVE  
WINSTON - SALEM NC 27106  
Phone (336) 924-9864  
Fax (336) 922-1458

**TOM JOHNSON CAMPING CTR.**  
6700 SPEEDWAY BLVD.  
CONCORD NC 28027  
Phone (704) 455-1440  
Fax (704) 455-1466

**TOM JOHNSON CAMPING CTR.**  
1885 US 70 WEST  
MARION NC 28752  
Phone (828) 724-4105  
Fax (828) 724-9057

## **NORTH DAKOTA**

**CAPITAL RV CENTER**  
1900 N. BISMARCK EXPY  
BISMARCK ND 58501  
Phone (701) 255-7878  
Fax (701) 255-1678

## **OHIO**

**AMOS MOTOR & RV**  
109 S MAIN STREET  
BRADNER OH 43406  
Phone (419) 288-2700  
Fax (419) 288-3273

**ARBOGAST RV DEPOT**  
3540 SOUTH COUNTY ROAD 25A  
TROY OH 45373  
Phone (937) 335-0068  
Fax (937) 335-0471

**BEGGS RV CENTER**  
11197 CLEVELAND AVE NW  
P.O. BOX 545  
UNIONTOWN OH 44685  
Phone (330) 499-9755  
Fax (330) 499-5106

**BEGGS RV CENTER**  
6075 DRESSLER ROAD NW NORTH  
CANTON OH 44720  
Phone (330) 494-3811  
Fax (330) 494-8255

**COLERAIN RV**  
3491 STRUBLE ROAD  
CINCINNATI OH 45251  
Phone (513) 923-3600  
Fax (513) 245-5145

**FARBER MOTORS**  
5858 SCARBOROUGH BLVD.  
COLUMBUS OH 43232  
Phone (614) 864-7878  
Fax (614) 864-7899

**YONAKS INC.**  
46293 BELMONT CENTERVILLE  
BELMONT OH 43718  
Phone (740) 686-2999  
Fax (740) 686-2788

## OKLAHOMA

**DAVE'S CLAREMORE RV**  
24655 SOUTH HWY. 66  
CLAREMORE OK 74019  
Phone (918) 341-0114  
Fax (918) 341-8936

**LEE'S RV CITY**  
13111 N. BROADWAY EXT.  
EDMOND OK 73083-6250  
Phone (888) 933-9300  
Fax (405) 936-9323

## OREGON

**AL'S TRAILER SALES OF SALEM**  
31873 OLD HWY. 34  
TANGENT OR 97389  
Phone (541) 926-4243  
Fax (541) 926-4244

**CARRIER & SONS RV SERVICE**  
29525 AIRPORT ROAD  
EUGENE OR 97402  
Phone (541) 461-1673  
Fax (541) 461-1674

**EUGENE RECREATION SALES**  
1700 HWY. 99 NORTH  
EUGENE OR 97402  
Phone (541) 688-4849  
Fax (541) 688-1885

**LARRY'S RV INC.**  
20630 GRANDVIEW DR.  
BEND, OR 97701  
Phone (541) 388-7552  
Fax (541) 388-7526

**OLINGER TRAVEL HOMES**  
6503 ALEXANDER  
HILLSBORO OR 97123  
Phone (503) 649-2141  
Fax (503) 642-9579  
[www.olingertravelhomes.com](http://www.olingertravelhomes.com)

**OLINGER TRAVEL HOMES**  
24000 NE SANDY BLVD.  
PORTLAND OR 97060  
Phone (503) 771-2121

Fax (503) 771-4638  
**THE RV CORRAL**  
1890 HWY. 99 NORTH  
EUGENE OR 97402  
Phone (541) 689-9204  
Fax (541) 689-9415

**TRIPLE A RV CENTER INC.**  
938 CHEVY WAY  
MEDFORD OR 97504  
Phone (541) 772-1938  
Fax (541) 779-1460

## PENNSYLVANIA

**ANSLEY RV**  
1280 ROUTE 764  
DUNCANSVILLE PA 16635  
Phone (814) 695 9817  
Fax (814) 695-9814

**COUNCIL CUP TRAILER SALES**  
ROUTE 239  
WAPWALLOPEN PA 18660  
Phone (570) 379-3751  
Fax (570) 379-2913

**HAROLD'S RV CENTER**  
7514 BETH BATH PIKE  
BATH PA 18014  
Phone (610) 837-9880  
Fax (610) 837-9473

**TOM SCHAEFFER'S CAMPING AND TRAVEL CENTER, INC.**  
1236 POTTSVILLE PIKE  
SHOEMAKERSVILLE PA 19555  
Phone (610) 562-3071  
Fax (610) 562-6764

## RHODE ISLAND

**ARLINGTON RV SUPER CENTER**  
966 QUAKER LANE  
EAST GREENWICH RI 02818  
Phone (401) 884-7550  
Fax (401) 885-4566

## SOUTH CAROLINA

**JOHN'S RV SALES & SERVICE**  
242 GLASSMASTER ROAD  
LEXINGTON SC 29072  
Phone (803) 359-2957  
Fax (803) 359-9121

**TONY'S RV PARTS & SERVICE**  
130 POND BRANCH RD  
LEXINGTON SC 29073  
Phone (803) 894-4868  
Fax (803) 894-5385

## TENNESSEE

**BUDDY GREGG MOTOR HOMES**  
11730 SNYDER ROAD  
KNOXVILLE TN 37933  
Phone (865) 675-1986  
Fax (865) 966-0701

**SHADRACK WATERSPORTS INC.**  
2537 VOLUNTEER PARKWAY  
BRISTOL TN 37620  
Phone (423) 652-0120  
Fax (423) 652-0267

## TEXAS

**AMERICAN RV CENTERS, LLC**  
8805 NORTH DESERT BLVD.  
ANTHONY TX 79821  
Phone (915) 298-5400  
Fax (915) 298-7991

**CAMPER COACHES LTD.**  
1701 SOUTH LOOP 289  
LUBBOCK TX 79423  
Phone (806) 748-7274  
Fax (806) 748-7277

**EAST TEXAS RV SALES**  
P.O. BOX 250  
KIRBYVILLE TX 75956  
Phone (409) 423-4032  
Fax (409) 423-5824

**RON HOOVER CO.**  
29277 I.H. 10 WEST  
BOERNE TX 78006  
Phone (830) 755-2252  
Fax (830) 755-8644

**RON HOOVER CO.**  
101 EXPRESSWAY 83  
DONNA TX 78537  
Phone (956) 464-4403  
Fax (956) 464-5684

**RON HOOVER CO.**  
16465 KATY FREEWAY  
HOUSTON, TX 77094  
Phone (281) 829-1560  
Fax (281) 829-9562

**RON HOOVER CO.**  
1510 W. MARKET STREET  
ROCKPORT TX 78382  
Phone (361) 729-9695  
Fax (361) 729-3829

**VOGT MOTOR HOMES**  
5624 AIRPORT FREEWAY  
FORT WORTH TX 76117  
Phone (817) 831-4222  
Fax (817) 838-5574

## UTAH

**TRAVEL VILLAGE**  
4360 S. STATE  
MURRAY UT 84107  
Phone (801) 268-1110  
Fax (801) 268-1115

## VERMONT

**VT COUNTRY CAMPER SALES**  
1498 ROUTE 2  
E. MONTPELIER VT 05651  
Phone (802) 223-6417  
Fax (802) 223-3561

## VIRGINIA

**CHEEK & SHOCKLEY RV'S INC**  
2600 MECHANICSVILLE PIKE  
RICHMOND VA 23223  
Phone (804) 649-7508  
Fax (804) 649-0052

**KOUGLER SALES & SERVICE**  
2247 JEFFERSON HWY.  
FISHERSVILLE VA 22939  
Phone (540) 942-5556  
Fax (540) 943-0853

## WASHINGTON

**CHIEF'S RV CENTER**  
1120 N. 28TH AVE.  
PASCO WA 99302  
Phone (509) 547-1198  
Fax (509) 547-4399

**WATT'S RV CENTER**  
22401 88<sup>TH</sup> AVE.  
KENT WA 98031  
Phone (253) 854-7026  
Fax (253) 854-1773

**WESTERN MOTOR COACH**  
19303 HWY. 99  
LYNNWOOD WA 98036  
Phone (425) 778-1248  
Fax (425) 670-2420

## WEST VIRGINIA

**TRAILER CITY INC.**  
2045 FAIRMONT AVE.  
FAIRMONT WV 26554  
Phone (304) 366-7104  
Fax (304) 363-9345

## WISCONSIN

**A O K RV SALES**  
5723 FREITAG DRIVE  
MENOMONIE WI 54751  
Phone (715) 235-0641  
Fax (715) 235-1230

**FINNEGANS RV**  
205 PARK AVE.  
BELOIT WI 53511  
Phone (608) 365-2306  
Fax (608) 365-3569

**HORN'S SALES & SERVICE**  
8120 S. FRONTAGE ROAD  
SHEBOYGAN WI 53081  
Phone (920) 564-2381  
Fax (920) 564-2385

## WYOMING

**EASTSIDE MOTORS & RV'S INC.**  
1200 E. SECOND ST.  
GILLETTE WY 82717  
Phone (307) 686-1435  
Fax (307) 682-1435

**JOLLEY ROGERS RV**  
6102 E. HWY. 30  
CHEYENNE WY 82001  
Phone (307) 634-8457  
Fax (307) 432-9796

## ALBERTA

**MAJESTIC RV WORLD**  
2777 SUNRIDGE BLVD. NE  
CALGARY AB T1Y 3C2  
Phone (403) 291-1203  
Fax (403) 291-9561

**VELLNER LEISURE PRODUCTS**  
1890 49 AVENUE  
RED DEER AB T4R 2N7  
Phone (403) 343-1464  
Fax (403) 340-8135

**WOODY'S RV WORLD**  
1702 49TH AVENUE  
RED DEER AB T4R 2N7  
Phone (403) 346-1130  
Fax (403) 341-4380

## ALBERTA

**MAJESTIC RV WORLD**  
2777 SUNRIDGE BLVD. NE  
CALGARY AB T1Y 3C2  
Phone (403) 291-1203  
Fax (403) 291-9561

## VELLNER LEISURE PRODUCTS

1890 49 AVENUE  
RED DEER AB T4R 2N7  
Phone (403) 343-1464  
Fax (403) 340-8135

## WOODY'S RV WORLD

1702 49TH AVENUE  
RED DEER AB T4R 2N7  
Phone (403) 346-1130  
Fax (403) 341-4380

## BRITISH COLUMBIA

**MIDTOWN RV LTD.**  
310 INDUSTRIAL AVE. WEST  
PENTICTON BC V2A 9B3  
Phone (250) 492-5705  
Fax (250) 492-0430

## TRAVELAND RV SUPERCENTER

20529 LANGLEY BY PASS  
LANGLEY BC V3A 5E8  
Phone (604) 530-8141  
Fax (604) 530-9576

**TRIANGLE RV CENTRE LTD.**  
10299 MC DONALD PARK ROAD  
SIDNEY BC V8L 5X7  
Phone (250) 656-1122  
Fax (250) 656-2161

## MANITOBA

**WALT'S TRAILER SALES LTD.**  
5195 PORTAGE AVE.  
HEADINGLY MB R4H 1E1  
Phone (204) 837-8388  
Fax (204) 831-8674

## MANITOBA

**WALT'S TRAILER SALES LTD.**  
5195 PORTAGE AVE.  
HEADINGLY MB R4H 1E1  
Phone (204) 837-8388  
Fax (204) 831-8674

## NOVA SCOTIA

**FRASERWAY RV CENTRE LTD.**  
212 ROCKY LAKE DRIVE  
BEDFORD NS B4A 2T7  
Phone (902) 835-8377  
Fax (902) 835-8376

## ONTARIO

**1000 ISLANDS RV CENTRE INC.**  
409 COUNTY ROAD #2  
GANANOQUE ON K7G 2V4  
Phone (613) 382-4400  
Fax (613) 382-2466

**RV WAREHOUSE**  
65 REIVE BLVD.  
COOKSTOWN ON L0L 1L0  
Phone (705) 458-4774  
Fax (705) 458-4446

**WILLIAM PATTERSON RV SALES**  
28359 PIONEER LINE  
DUTTON ON N0L 1J0  
Phone (519) 762-2125  
Fax (519) 762-3386

## QUEBEC

**MOTORISES LE BLANC SAGUENAY,  
INC.**  
1950 DES LAURENTIDES BLVD.  
VIMONT LAVAL PQ H7M 2Y2  
Phone (450) 663-7941  
Fax (450) 663-2213

## SASKATCHEWAN

**#1 RV CENTRE LTD.**  
HWY. #1 EAST & THATCHER DR.  
MOOSE JAW SK S6H 4N9  
Phone (306) 691-7770  
Fax (306) 691-1056

# IMPORTANT RV TIRE INFORMATION

READ AND UNDERSTAND THE FOLLOWING INFORMATION BEFORE TAKING YOUR FIRST TRIP IN YOUR RV!

## WARNING

Routine maintenance on your RV is important, but it cannot be overstated just how critical proper tire maintenance is to the safety, operation, and durability of your new unit.

To insure your tires are operating safely, regular inspection of your tires, and checking of tire pressures is absolutely mandatory. FAILURE TO FOLLOW PROPER INFLATION GUIDELINES MAY RESULT IN TIRE FAILURE, WHICH, UNDER CERTAIN CIRCUMSTANCE CAN CAUSE LOSS OF VEHICLE CONTROL OR ACCIDENTS THAT MAY RESULT IN PROPERTY DAMAGE, BODILY INJURY, AND / OR DEATH.

For safe operation and maximum weight carrying capacity, it is imperative that the tires be inflated to and maintained at the listed tire pressures on the Federal ID Tag that is affixed to the interior wall just behind the driver's seat in motorhomes, and to the lower front corner of the road side sidewall on fifth wheel trailers. Below is a sample of the Federal ID Tag you will find with your RV.

IT IS PARAMOUNT TO THE SAFE OPERATION OF THE VEHICLE TO MAINTAIN PROPER TIRE PRESSURES. TIRE PRESSURES SHOULD BE CHECKED AND ADJUSTED BEFORE AND AFTER EACH TRIP, AND SHOULD ALWAYS BE CHECKED AND ADJUSTED WITH THE TIRES COLD. NEVER ADD OR RELEASE PRESSURE FROM THE TIRES WHEN THEY ARE HOT (AFTER HAVING DRIVEN A MILE OR MORE).

For additional information on your tires, contact the Newmar Corporation.

MANUFACTURED BY / FABRIQUE PAR:		DATE:		
GVWR/PMBV		KG (	LB)	
FRONT/ AVANT	GAWR/PMBE	KG	TIRES/PNEU	RIMS/JANTE
(	LB)			COLD INFL. PRESS./PRESS. DE GONFL. A FROID
				KPA SINGLE DUAL
				PSI(LPC) <input type="checkbox"/> <input type="checkbox"/>
INTERM/ INTERM	KG			KPA SINGLE DUAL
(	LB)			PSI(LPC) <input type="checkbox"/> <input type="checkbox"/>
REAR/ ARRIERE	KG			KPA SINGLE DUAL
(	LB)			PSI(LPC) <input type="checkbox"/> <input type="checkbox"/>
THIS VEHICLE CONFORMS TO ALL APPLICABLE U.S. FEDERAL MOTOR VEHICLE SAFETY STANDARDS IN EFFECT ON THE DATE OF MANUFACTURE SHOWN ABOVE.				
THIS VEHICLE CONFORMS TO ALL APPLICABLE STANDARDS PRESCRIBED UNDER THE CANADIAN MOTOR VEHICLE SAFETY REGULATIONS IN EFFECT ON THE DATE OF MANUFACTURE. - CE VEHICULE EST CONFORME A TOUTES LES NORMES QUI LUI SONT APPLICABLES EN VERTU DU REGLEMENT SUR LA SECURITE DES VEHICULES AUTOMOBILES DU CANADA EN VIGUEUR A LA DATE DE SA FABRICATION.				
V.I.N./N.L.V.:		TYPE/TYPE:		FD-228

## SAFETY PRECAUTIONS

### Towing

While driving on slippery surfaces, use care when accelerating or decelerating. Skidding and loss of vehicle control may be the result of abrupt changes in speed.

Driving through water deep enough to wet the brakes may affect the stopping distance or cause the vehicle to pull to one side. If you have driven through deep water, check the brake operation in a safe area to be sure they have not been affected. Never operate a vehicle if a difference in braking efficiency is noticeable.

Extreme terrain and adverse weather may affect the handling and/or performance of your vehicle.

### Propane Gas

While the Propane tanks must be removed before refilling, it is recommended that all pilot lights are extinguished and appliances turned off. Smoking is also prohibited at this time. Exhaust gases, which contain carbon monoxide (an odorless, colorless, and poisonous gas), are produced by burned gasoline, diesel or Propane gas in items such as the range, tow vehicle engine, generator engine, refrigerator, furnace, and water heater. These fumes should not be inhaled.

An open flame is never to be used to test for Propane gas leaks. All protective covers and caps must be replaced after filling the Propane system. Once the Propane valve is closed, securely latch the Propane door. Propane gas and natural gas are not interchangeable. Never connect natural gas to the Propane gas system.

The use of equipment such as wood and charcoal grills and stoves inside this recreational vehicle may cause fires or asphyxiation.

### Propane Gas System General Information

A warning label has been placed near the Propane gas container. This label reads:

Over filling the Propane gas container can result in uncontrolled gas flow, which can cause fire or explosion. A properly filled container will hold approximately 80 percent of its volume as liquid Propane gas.

The Propane gas system components in your unit have been approved for use in camping vehicles by a nationally recognized testing laboratory. Propane gas is a clean-burning dependable fuel when properly handled. The Propane gas tank(s) mounted on your unit contain liquid petroleum gas under high pressure. The liquid gas vaporizes as the fuel is used and passes through the tank valve to a regulator that automatically reduces the pressure. The low-pressure gas is then distributed to the appliances through the pipe manifold system. Appliance lighting problems are commonly caused by an improperly adjusted gas regulator. Never attempt to reset the regulator yourself. Have an authorized service technician make any necessary adjustments. We recommend that you have the Propane gas system checked by an authorized service technician at least once a year, and after every extended trip. Although the manufacturer and dealer test carefully for leakage, travel vibrations could loosen fittings. Leaks can be easily found by applying leak detector solutions at the connections. If leak detector solution is not available, a soapy water solution made with dish soap can be used. Tightening the fitting usually stops any leaks. If this does not work, shut off the main gas valve at the tank and immediately consult an authorized technician for repairs. If a leak is suspected, the identifying odor smells similar to rotten eggs (sulfur). Never test for a leak by lighting a match or have an open flame where you suspect leaking gas.

**WARNING**

DO NOT FILL CONTAINER(S) TO MORE THAN 80 PERCENT OF CAPACITY.

**WARNING**

Propane gas containers, gasoline or other flammable liquids shall not be placed or stored inside the vehicle because fire or explosion may result. Propane gas containers are equipped with safety valves that relieve excessive pressure by discharging gas into the atmosphere.



## Propane Regulator

The regulator acts as the heart for the Propane gas system. The Propane gas in the tank is under high pressure. The regulator reduces the pressure of this gas so that it is safe to use with the various appliances in your unit. If corrosion is noticed, contact a qualified Propane gas service technician. Do not adjust the regulator. It is factory preset. Adjustments are to be made by a qualified Propane service technician using specialized equipment. Propane gas regulators must always be installed with the diaphragm vent facing downward. Regulators that are not in compartments have been equipped with a protective cover. Make sure that the regulator vent faces downward and that the cover is kept in place to minimize the vent blockage that could result in excessive gas pressure causing fire or explosion.

## Propane Distribution Lines

The primary manifold is a black steel pipe running the length of your unit. Most secondary lines leading to gas appliances are made of copper tubing with flare fittings. If any of the gas lines rupture, do not attempt to splice them. Always run a new line. We recommend gas distribution work be performed by an authorized service technician. The main valve at the Propane tank must be closed when removing or servicing any gas appliance. This will prevent dangerous gas leakage that could result in an explosion and possibly serious injury. If a leak is suspected, have the systems inspected and repaired by a qualified service technician.

### WARNING

Shut off the main gas valve at the tank when the camping vehicle is not in use. Also, shut off the valve when refueling to avoid potential danger from pilot lights igniting fuel fumes. Some appliances, such as the refrigerator, water heater, and furnace, have DSI (direct spark ignition) boards so it is important that you turn the appliances off when the Propane gas is off. The ignition in the appliances will continue to spark even if there is no Propane gas available.

## Precautions & Recommendations

- Inspect the Propane fill valve for foreign materials before refueling.
- Shut the pilot lights off prior to refueling Propane gas tanks.
- Never check for gas leaks with an open flame (match, etc.).

- Gas lines should be visually inspected periodically.
- Have the gas system inspected yearly and before and after extended trips.
- The gas system should be inspected and repaired by qualified technicians only.

### **Fire Safety**

The possibility of fire exists in all areas of life, and the recreational life-style is no exception. Recreational vehicles are complex machines. They are made up of many materials, some of which are flammable. Like most hazards, the possibility of fire can be minimized, if not totally eliminated. This is done by recognizing the danger and practicing common sense safety and maintenance habits. For safety reasons, your unit is furnished with both a fire extinguisher and a smoke alarm.

### **Fire Extinguishers**

The fire extinguisher is rated for Class B (grease, gasoline, diesel fuel, flammable liquids) and Class C (electrical) fires. These are the most common types of fires in vehicles. Read the operator's manual and the instructions on the fire extinguisher. Be sure to know how and when to use the extinguisher and where it is located. Fire extinguishers are mechanical, pressurized devices. Care must be exercised when they are handled. They must be maintained as the operator's manual instructs for proper and safe operation. The extinguisher should be inspected at least once a month. More frequent inspections may be required if the extinguisher is exposed to the weather or to possible tampering. Do not test the extinguisher by partially discharging. Doing this will cause a loss of pressure.

If a fire occurs in the vehicle, evacuate the vehicle as quickly and as safely as possible. Consider the cause and the severity of the fire and the risk involved before trying to extinguish it. If the fire is major or fuel fed, move away from and stand clear of the vehicle and wait for emergency assistance to arrive.

## WARNING

The Propane system in your recreational vehicle is designed for liquefied petroleum gas only. Never attempt to connect natural gas or butane gas in this system.

### Smoke Detector

The battery powered smoke detector is mounted on the ceiling in the living area of the unit. Read the operating instructions for details on the testing and care for this important safety device. Test the smoke detector after the unit has been in storage, before each trip, and at least once a week during use. The detector should never be disabled because of nuisance or false alarm from cooking smoke or a dusty furnace. Ventilate the unit with fresh air and the alarm will shut off.

Never disconnect or remove the battery from the smoke alarm. The battery should be replaced once a year or when the low battery signal sounds.

### Emergency Exit Window

In the bedroom or slide out of the unit, there may be an emergency exit (egress) window. This window is designed to be used as an additional exit in emergency situations. It can be easily identified by the red handle and the red EXIT label. To open the egress window, lift the handle and push outward on the window. The window can be closed by pulling the window shut and lowering the handle in the down or locked position.

### Weight Information

Below is a sample of a weight information label in your unit.

### Weighing the Unit

The following definitions are given to help in communications of issues of weight and your unit.

**GAWR:** Gross Axle Weight Rating is the maximum permissible weight for an axle.

**GCWR:** Gross Combination Weight Rating is the value specified by the manufacturer of the vehicle as the maximum allowable loaded weight of this motorhome and any towed trailer or towed vehicle.

**GVWR:** Gross Vehicle Weight Rating is the maximum permissible weight of this fully loaded motorhome. The GVWR is equal to or greater than the sum of the Unloaded Vehicle Weight plus the Cargo Carrying Capacity.

**UVW:** Unloaded Vehicle Weight is the weight of this motorhome as built at the factory with full fuel, engine oil, and coolants. The UVW does not include cargo, fresh water, Propane gas, or dealer installed accessories.

**CCC:** Cargo Carrying Capacity is equal to GVWR minus each of the following: UVW, full fresh (potable) water weight (including water heater), full Propane-Gas weight and SCWR.

**GVW:** Gross Vehicle Weight is the weight of the unit with all items and supplies that are loaded into the unit at any point in time.

**SCWR:** Sleeping Capacity Weight Rating is the manufacturer's designated number of sleeping positions multiplied by 154 pounds (70 kilograms).

**NOTE:** The sales literature may give approximates or standards. Each individual unit may weigh differently based on the factory and/or dealer options added. To assure the accuracy of your weights be sure the unit is always level during weighing. The unit has been built to comply with the component suppliers recommended limits and give you a realistic CCC.

TOWABLE WEIGHT INFORMATION		2005 NMF35ABCD
Newmar Serial Number	<b>123456</b>	VIN # <b>1N8BS945460123456</b>
GVWR (Gross Vehicle Weight Rating) is the maximum permissible weight of this trailer when fully loaded. It includes all weight at the trailer axle(s) and tongue or pin.		
UVW (Unloaded Vehicle Weight) is the weight of this trailer as built at the factory. It also include all weight at the trailer axle(s) and tongue or pin. If applicable, it also includes full generator fluids, including fuel, engine oil and coolants.		
CCC (Cargo Carrying Capacity) is equal to GVWR minus each of the following: UVW, full fresh (potable) water weight (including water heater), full LP-Gas weight.		
<b>CARGO CARRYING CAPACITY (CCC) COMPUTATION</b>		
		<u>pounds (kilograms)</u>
GVWR.....	16250	(7364)
minus UVW.....	13980	(6333)
minus fresh water of 81 gallons @ 8.3 lb/gal	672	(306)
minus LP-Gas weight of 14 gallons @ 4.2 lb/gal	59	(27)
CCC for this trailer*	1535	(695)
*Dealer installed equipment will reduce CCC		
CONSULT OWNER'S MANUAL FOR SPECIFIC WEIGHING INSTRUCTIONS AND TOWING GUIDELINES.		

When loading the unit, distribute the items so that not all of the weight is added to one area of the unit. If you have questions as to what the weight of the unit is after it has been loaded, take the unit to a drive-on scale or use individual wheel scales and verify that the weights are within the limits of those specified for the unit. When weighing the unit, follow these instructions. Failure to follow these instructions may give an erroneous weight reading.

1. Pull the unit onto the scales shown in Fig. 1. This is the total weight of the unit. To do this, put the front jacks down far enough to take all of the weight off of the tow vehicle and onto the scales. Make sure that only the trailer is on the scales. Record the weight. This is the GVW and should not exceed the GVWR supplied by Newmar for the unit.
2. Hook up to the unit and be sure, again, that there is no part of the tow vehicle on the scales as shown in Fig 2. Weigh the unit with only the trailer tires on the scales. Record the weight. This is the total weight on the axles. When this amount is subtracted from the GVW (first reading), the difference is the hitch weight. To achieve the approximate weight on each axle, divide the weight from Fig. 2 by the number of axles. This amount should not exceed the GAWR of the unit. For example 9,360 pounds with 2 axles is 4,680 pounds per axle or approximately 2,340 pounds per tire.

## Hitching Fifth Wheels

Hooking the fifth wheel will become quite simple after a little practice. Follow the steps listed below.

1. Adjust the fifth wheel jacks until the trailer is at the height level for hooking to the tow vehicle.
2. Place wheel chocks behind the wheels of the coach.

### IMPORTANT

Your fifth wheel is equipped with electrically activated trailer brakes. Make sure the proper brake controls are installed and in working order before traveling. Be sure that there is a positive and negative line from the battery of the tow vehicle to the seven-way plug on the fifth wheel. This will assure that there is adequate electrical current to the braking system at all times.

3. Release the fifth wheel lock handle.
4. Align the tow vehicle so the fifth wheel will accept the kingpin.
5. Back the tow vehicle slowly into the fifth wheel until the kingpin engages in the fifth wheel lock, automatically locking.

6. Verify that the lock is closed.
7. Connect the electrical pigtail between the fifth wheel and the tow vehicle.
8. Connect the break away switch line. Be sure the break away switch cable is not attached to any part of the tow vehicle hitch assembly. Make sure there is enough slack in the break-away cable to allow for turning.
9. Adjust the mirrors on the tow vehicle.
10. Check all of the lights on the fifth wheel and the tow vehicle (running lights, brake and tail lights, turn signal lights, and back up lights).
11. Pick up and store the wheel chocks.
12. Check the inside of the coach to verify that everything is stored properly, vents are closed, all of the doors and drawers are shut, and the TV antenna lowered. Close the entrance door and retract the steps.
13. Raise the fifth wheel jacks so the entire hitch load is on the tow vehicle. The jacks should be about 2" off of the ground. Do not raise the jacks completely until you have tested the brake control. This will also test the hook-up.
14. Pull the unit forward and apply the hand control for the trailer brakes to be sure they are operating properly.
15. Completely raise the fifth wheel jacks.

### **Campsite Parking**

If the campground does not have drive through sites, it is recommended to stop near the site and inspect it for slopes or uneven areas. Carefully back into the site. Watch for low-hanging limbs, posts, large rocks or other obstacles. Back in so the site is on the driver's left. This will enable the driver to watch the rear of the unit. Maneuver the vehicle into position before backing into the site. Back up slowly, using the side mirrors as a guide or with the assistance of another person outside, guiding the parking procedure.

Place the tow vehicle in park and turn off the ignition. Block all of the trailer wheels with wheel chocks. Side to side leveling should be done by using shims under the tires on the low side of the unit after it has been backed into the site. This must be done before disconnecting the trailer from the tow vehicle. Lower the stabilizing jacks, if installed. Connect the 120 volt shore power to the unit. Open the Propane gas valves at the Propane tanks. Connect the fresh water supply and sanitize the water systems (see Chapter 11), if necessary. Connect the waste drain hose to the sewer hookup. Start the refrigerator, water heater,

and furnace, if needed. Light the oven pilot light, if applicable. Remember that the refrigerator will not operate efficiently if the unit is not level.

## SECOND OWNER INFORMATION

Newmar Corporation strives to keep the most accurate and current customer information on file.

If you purchased this unit new, we have your information from the registration form on file. However, if you purchased this unit as used, then we asked that you complete the following information and mail it, or fax it, to us so that we can be certain that our records are updated.

Upon receipt of this form, we will send you a warranty registration card. This card is to be presented when you are having warranty work done on your unit at an authorized Newmar Service Center. Please note the date of purchase on the card will reflect that of the original date the vehicle was purchased, and is the date applicable warranties originated.

If you have any questions, please contact a Newmar representative.

Today's Date \_\_\_\_\_ Newmar Coach # \_\_\_\_\_

Year/Brand/Type \_\_\_\_\_ VIN # \_\_\_\_\_

Customer Full Name \_\_\_\_\_

Customer Full Address \_\_\_\_\_

\_\_\_\_\_

\_\_\_\_\_

Purchased from \_\_\_\_\_

Address \_\_\_\_\_

\_\_\_\_\_

**Send to:**                    **Newmar Corporation**  
                                  **Attention Service Department**  
                                  **PO Box 30**  
                                  **Nappanee, IN 46550**  
                                  **Fax # 574-773-2007**

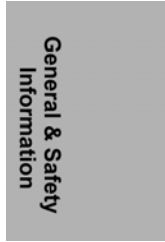



Chapter **3**

**HVAC, APPLIANCES & ACCESSORIES**

**HEATING & AIR CONDITIONING .....3**  
Air Conditioning..... 3  
Furnace ..... 4  
Propane Bottles ..... 5  
Propane Bottle Filling..... 6  
Propane Leak Detector..... 6  
Propane Regulator..... 7

**MAJOR APPLIANCES .....7**  
Refrigerator ..... 7  
Microwave..... 8  
Range Hood..... 9  
Range ..... 9  
Television Antenna ..... 10  
Television & Surround Sound System..... 11  
Video Control Center ..... 12  
Cable & Telephone Jack..... 12  
Water Heater ..... 12  
Water Heater Storage ..... 13  
Pressure Relief Valve ..... 13  
Washer/Dryer (Optional)..... 14  
Ceiling Fan..... 14

HVAC, Appliances  
& Accessories



# HEATING & AIR CONDITIONING

## Air Conditioning

The roof mounted central air conditioner installed on your unit will operate only when the unit is supplied with 120 volt AC power from the power cord or the optional generator. The air conditioner circuit breaker must be in the ON position it to work. The unit may be equipped with two air conditioners, if an option package was installed. Park the vehicle in the shade with the drapes or blinds closed for the best performance. Set the thermostat to the desired temperature while keeping the doors and windows closed. Keep in mind that air conditioners use a large portion of the available electric power.

RV parks may experience low voltage on days with high heat or humidity. This is commonly referred to as a brown out. A brown out may trip the air conditioner circuit breaker. The circuit breaker protects your air conditioner motor from damage and is necessary during low voltage conditions. The tripping breaker is not a fault in your electrical system. The cool air from the air conditioner is ducted throughout the coach through the cool air ceiling ducts. Warm air is returned to the air conditioner through return air ceiling ducts. Below is the thermostat that controls the air conditioner. It also controls the furnace. Simply select the desired temperature. The blower will cycle automatically, or you may choose low, medium or high fan settings.



**Step One:** Move power switch to ON.

**Step Two:** Press MODE to select function. (Cool\*, furnace, etc.)

**Step Three:** Press FAN to select high, med., or low speed.

**Step Four:** Press UP or DOWN to select temperature.

**Step Five:** If operating more than one zone, press ZONE and repeat steps 2-4 for each additional zone.

\*Expect a 2-minute delay for compressor to start.

**Shutdown:** If you turn the Comfort Control off or if there is a power interruption for any reason, the system will resume operation on the last settings when power returns.

## Furnace

The furnace(s) installed in your unit is a forced-air furnace fueled by Propane gas. If your unit is equipped with two furnaces, the living area furnace is controlled by the air conditioner wall thermostat that controls the heating, and cooling of the unit. The furnace installed in the bath/bedroom area is controlled by the thermostat in the bedroom. The heat is supplied to the unit through ducts in the floor. The furnace will not operate properly if the air flow at the floor registers, or the air return to the furnace, is blocked by personal or storage items. Storage under the cabinets should be done carefully to prevent crushing or damaging the furnace ducting or blocking of the cold air return. Smoke and fumes may be created as a result of the residual burn off of the manufacturing compounds that are sometimes present the first time the furnace is used. This is normal. To minimize the smoke and fumes, the initial lighting of the furnace should be done with the windows and doors open. Continue until the residue is completely burned off. To operate, set the thermostat to the desired temperature setting and turn the thermostat to the on position. Allow 60 seconds for the furnace to begin operating. To shut down the furnace, turn the thermostat to the off position. After the furnace has been turned off, the fan will run for approximately 60 seconds to cool down.

For your safety, do not use gasoline or other flammable liquids in the vicinity of the furnace or any other appliance. Clean the complete furnace and air tube passageways periodically to remove dust, lint, etc. Check the gas system for leaks at least once a year. Check and clean the blower wheel annually. On the exterior of the coach you will find a furnace cover. There are no owner serviceable parts on the furnace. This cover should be removed by authorized service technicians only. The furnace should be thoroughly cleaned before the start of each heating season. Any debris in the system may restrict air flow for combustion, bind the combustion air impeller, or prevent the blower motor from running properly. Also, check the burner pilot orifices for debris. Lint accumulations may cause the blower to become unbalanced, vibrate, restrict the ability of the blower to move air. If lint is blown into the heat exchanger, it may cause odors or create a fire hazard. Contact an authorized service technician for annual cleaning. Consult the manufacturer's operating instructions in your Owner's Package for further information.

**WARNING**

Use caution when washing the exterior of your vehicle. Water should not be sprayed directly into the furnace vent. If water is forced beyond the rain baffles into the furnace vent, rusting of the furnace could occur. This could also cause improper combustion.

**WARNING**

Never attempt to modify this furnace. Fire, explosion, asphyxiation, or carbon monoxide poisoning may occur. If the furnace malfunctions, consult a trained service technician.

**Propane Bottles**

This unit is equipped with two 30# Propane bottles. Two 40# Propane bottles may be installed as an option. These bottles are controlled with an automatic pressure regulator. The Propane bottles contain liquid petroleum gas under high pressure. As the fuel is used, the liquid gas vaporizes and passes through the tank valve to a regulator that automatically reduces the pressure. The low-pressure gas is then distributed to the appliances throughout the pipe manifold system. Improperly adjusted regulators are the major cause of appliance lighting problems. Never attempt to reset the regulator. This is to be done by a qualified service technician. While in high altitudes or extreme cold weather a gas shortage may be experienced. Using one appliance at a time can help adjust to this problem.

It is recommended to have the Propane system inspected by an authorized service technician at least once a year and after every extended trip. This system is tested by both the manufacturer and the dealer. Leaks can be caused by travel vibrations, therefore routine inspections are recommended.

The primary gas manifold is a black steel pipe running the length of the unit. All secondary lines leading to the gas appliances are made of copper tubing with flare fittings. If any of these lines rupture do not attempt to splice them. Always have a new line ran. Gas distribution work must be performed by an authorized service technician. When removing or servicing any gas appliance, close the main gas valve at the Propane bottles. This will prevent dangerous gas leakage that could result in an explosion and possible serious injury. If a

gas leak is suspected, have the system inspected and repaired by a qualified service technician as soon as possible.

### Propane Bottle Filling

**Do not fill the bottles to more than 80 percent of capacity. Fire or explosion may be the result of uncontrolled gas flow from an overfilled tank.**

#### **WARNING**

The main gas valve must be shut when the vehicle is not in use. Shut the valve off when refueling to avoid potential danger from pilots lights igniting fuel fumes. Gas valves on appliances with direct spark ignition (DSI) should also be in the off position. Do not store Propane, gasoline, diesel, or other flammable liquids inside the vehicle. Fire or an explosion could be the result of ignoring this warning.

#### **WARNING**

Portable fuel burning appliances are not safe for heating inside the recreational vehicle. Asphyxiation or carbon monoxide poisoning can occur.

The presence of moisture in Propane fuel causes the regulators to freeze. The moisture will pass through the cylinder valve and into the regulator where freezing occurs. To help prevent the regulator from freezing, always keep the tank control valve closed when not in use, even when the tank is empty, to prevent moisture from collecting on the inside. If moisture becomes a problem, consult an authorized Propane service center for assistance.

### Propane Leak Detector

Liquid Propane (Propane) Gas is heavier than air and will settle to the lowest point of the room, which is generally on the floor of your coach. Because of this, the Propane detector installed in your coach is located near the floor. The detector is also sensitive to other fumes, such as hair spray, which contain butane as the propellant. Butane, like propane, is heavier than air and will settle to the floor level where it may be detected. When this occurs, press the reset button to stop the alert sound for 60 seconds.

The detector is equipped with a sensor activation strip. This strip must be removed for the detector to operate properly. This should have been done

during the dealer's Pre-Delivery Inspection. Please check the detector to verify that the activation strip has been removed. Please consult your Propane detector User's Guide for more detailed information.

#### **WARNING**

Never check gas lines for leaks with an open flame. Do not check for leaks using ammoniated or chlorinated household type detergents. These detergents can cause cracks to form on the metal tubing and brass fittings. Take the unit to a qualified Propane gas service technician to find and repair the leak. Keep the tank valve closed and all of the appliances turned off when the unit is stored. If any of the Propane gas valves do not close leak-tight by hand, consult a service technician.

### **Propane Regulator**

The regulator is the heart of the Propane system. The regulator reduces the pressure of the gas so it is safe to use with various appliances. Regulators are equipped with a vent. In the event excess pressure builds up in the body of the regulator, a relief mechanism vents it to the atmosphere. It will vent until the pressure returns to the normal range. The vent must be kept clean and clear of obstructions or corrosion. A clogged vent could cause the failure of components. Contact a qualified Propane technician if corrosion or obstruction is noticed.

## **MAJOR APPLIANCES**

### **Refrigerator**

Before starting the refrigerator, verify that the main Propane gas valve is in the on position. The refrigerator is equipped with a semi-automatic energy selector (AES) control system. It can be set to select either 120 volt or Propane gas operation, automatically, if desired. A 12 volt power supply must be available for the electronic control panel to function. The shore line must be plugged in, or the optional generator running, to operate in the 120 volt mode. The main Propane gas valve must be open for operation in the Propane mode. To start the refrigerator, press the main power ON/Off button to the ON position.

To use the 2-way Auto Mode, push the AUTO/GAS mode selector into the ON position. If 120 volt is available, the AC mode indicator light will be illuminated designating AC operation. If 120 volt is not available, the gas mode indicator light will be illuminated. The control system will automatically

switch to gas operation. To operate on gas only, push the AUTO/GAS mode selector until the gas indicator light has lit. After 45 seconds, the burner should be ignited and operating normally. The initial start up may take longer than 45 seconds in order to allow the air to be purged from the gas line. If the gas does not ignite within 45 seconds, the check indicator light will illuminate and the gas mode light will go off. If the check indicator light illuminates and the gas mode indicator light is off, then the controls have failed to ignite the burner in the gas mode. When the check indicator light is on, press the main power ON/OFF button to the off position to reset. Do not continue to reset the gas operation if the check indicator light continues to illuminate after several tries. The thermostat on the refrigerator controls the gas and electric operation. This eliminates the necessity of resetting the temperature each time a different energy source is used. Press the temperature selector button until the light at the desired setting is illuminated. After the initial start up, the thermostat should be moved from the coldest setting to the desired setting, which is usually mid range. An optional feature on the refrigerator is the addition of an icemaker. For detailed operating instructions, please consult the manufacturer owner's manual in the Owner's Information Packet.

#### **WARNING**

Most Propane gas appliances used in recreational vehicles are vented to the outside of the vehicle. When parked close to a gasoline pump it is possible that the gasoline fumes could enter this type of appliance and ignite the burner flame causing a fire or explosion. Use caution when refueling.

### **Microwave**

Standard in your unit is a 22" microwave oven. As an option, your unit may be installed with a 30" convection microwave with a three burner cooktop. All of the microwave ovens installed by Newmar operate in the same manner. The microwave's control panel is the touch pad type. Simply enter the temperature, mode, and cooking time desired. For instructions on how to operate any of the special features on the microwave oven, please refer to the microwave owner's manual in your Owner's Information Package.

If the microwave contains the range hood, the hood is controlled by the microwave control panel. Refer to the microwave owner's manual for further instruction on the hood operation.



## Range Hood

A range hood may be incorporated into the microwave. The microwave's control panel operates the range hood functions. This range hood has both a fan and a light for your convenience. The fan has two speeds which are low and high. Simply select the desired setting from the microwave's control panel. For further detailed information on the hood operation, refer to the microwave Owners Manual.

## Range

Your unit may be equipped with a three burner recessed range with a glass oven door and electronic ignition. There are different models used in the Newmar product line with different types of controls. To light the burners on some models, turn the control knob to turn the gas on. Wait a couple of seconds, then push the red spark button until a flame appears. On other models, after the gas control has been turned on, turn the spark control knob until a flame appears. All burner controls operate counter clockwise and have to be pushed inward in order to turn. On units with an oven, the oven control must also be pressed inward before turning. To light the oven, push in the oven control knob and rotate counter clockwise to the PILOT ON position. Light the oven pilot light located at the back left-hand side of the oven burner. The oven pilot may be slow in lighting due to initial air in the gas line. The oven pilot has been factory adjusted. No further adjustments are necessary. To extinguish the oven pilot, push in the oven control knob and turn clockwise to the "Off" position. For further instructions, please refer to the oven manufacturer owner's manual in your Owner's Information Package.

Your range may be equipped with a bi-fold range cover that matches your countertop material. This cover helps to protect the burners when they are not in use. Before cooking on the range top, the cover must be in the full upright and folded position, preventing the cover from falling on the range top during cooking. Never close the cover while the burners are in use and do not use the cover as a griddle or cooking surface. Never use the range while the RV is moving and remember to close the bi-fold cover when the range top is not in use.

For further instructions, please refer to the oven manufacturer owner's manual in your Owner's Information Package.

The following warning label has been placed in the cooking area to remind the user to provide an adequate supply of fresh air for combustion:

<b>WARNING</b>
<p>It is not safe to use cooking appliances for comfort heating. Cooking appliances need fresh air for safe operation. Before operation:</p> <ol style="list-style-type: none"><li>1. Open overhead vent or turn on an exhaust fan.</li><li>2. Open a window.</li></ol> <p>Unlike homes, the amount of oxygen supply is limited due to the size of the recreational vehicle. Proper ventilation when using the cooking appliance(s) will avoid dangers of asphyxiation. It is especially important that cooking appliances not be used for comfort heating as the danger of asphyxiation is greater when the appliance is used for long periods of time.</p>

The following label has been placed in the vehicle near the range area:

<b>If You Smell Gas:</b>
<ol style="list-style-type: none"><li>1. Extinguish any open flames, pilot lights, and all smoking materials.</li><li>2. Do not touch electrical switches.</li><li>3. Shut off the gas supply at the tank valve(s) or gas supply connection.</li><li>4. Open doors and other ventilating openings.</li><li>5. Leave the area until the odor clears.</li><li>6. Have the gas system checked and leakage source corrected before using again.</li></ol>

### Television Antenna

A TV antenna with a power booster is installed in your coach and is designed for reception of all color and black-and-white channels. If the reception is poor, you should verify that the power switch is in the “ON” position and that all of the connectors are tight. If poor reception still occurs, consult your authorized dealer.

To raise the antenna into the operating position, turn the elevating crank (clockwise) in the “UP” direction, about 13 turns, or until some resistance to turning is noticed. On the power booster, turn the switch to “ON” in order to amplify the signal being received. Once in the “UP” position, rotate the antenna to receive the best picture. This is done by pulling down on the directional handle with both hands until it disengages from the ceiling plate and then rotating it until reception has improved. The antenna must be lowered

HVAC, Appliances  
& Accessories

before moving the vehicle. To lower, rotate the directional handle until the pointer is aligned with the pointer on the ceiling plate. Turn the elevating crank (counter-clockwise) in the “DOWN” direction, about 13 turns, or until some resistance to turning is noticed. The antenna is now locked and in the travel position. Your unit may be equipped with one exterior antenna jack and two interior antenna jacks.

RAISING ANTENNA TO OPERATING POSITION

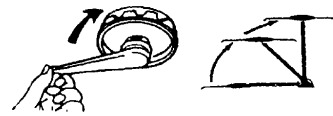

ROTATING ANTENNA FOR BEST PICTURE



LOWERING ANTENNA TO TRAVEL POSITION



### CAUTION

Under no circumstances should you lower the antenna in any position except the travel position.

## Television & Surround Sound System

The coach is cable ready and is equipped with a color television in the entertainment center located in the living room. To enhance the viewing experience, a “Surround Sound” Home Theater Package has been installed as well. This system consists of a “Surround Sound” receiver with integral DVD player, five speakers, and a powered subwoofer to provide full, rich sound. The system and televisions are powered by 120 volt electricity. Your unit must be plugged into shore power, or have the optional generator running, in order for the television and surround sound system to work. Please consult the individual components owner’s manuals for further information. There are two interior jacks and one exterior jack installed for televisions to receive the antenna signal. An optional exterior television jack on the door-side of the coach is available. Your unit is also pre-wired for a satellite system.

## Video Control Center

The Video Control Center provides input for a variety of video sources, and distribution



of those video signals to all the televisions and the VCR in the RV. It also allows the freedom to view any of the input sources (antenna, satellite, VCR, DVD, etc.) simultaneously and /or independently on each TV in the unit. It also houses the “Antennae Booster”, which provides an amplified signal to improve viewing “off air” local broadcasting in fringe areas.

## Cable & Telephone Jack

Cable television jacks are featured on your unit. An interior jack may be installed where specified and another jack may be an exterior jack located in the electric compartment. An additional feature in this unit is the telephone hook up. This includes the connector for the incoming telephone line and one telephone outlet inside the unit.

## Water Heater

area for gas. Be sure to smell next to the floor because some gas is heavier than air and will settle. Before lighting the water heater fill the fresh water system. Purge any air from the water heater by opening all hot water faucets until water flows steadily from each one. The water heater installed in this unit is a ten-gallon gas/electric model with direct spark ignition (DSI). This water heater operates on Propane gas or 120 volt electricity. It is important to read all of the safety information provided in the water heater manufacturer operation manual in the Owner’s Information Packet. This appliance does not have a pilot light. It is equipped with an ignition device which automatically lights the burner. Do not try to light the burner by hand. Before lighting, smell all around the appliance on the floor. Consult the Operation Manual for further instructions if a gas leak is noticed. The gas valve is fully automatic, no adjustments are necessary. Read the safety information provided in the Operation Manual before lighting the appliance. Turn off all electrical power to the water heater. Turn the gas supply to the OFF position. Wait five minutes for the gas to clear the area. If you smell gas, STOP! Following the safety instructions in the Operations Manual. If gas odor is not noticed than turn the gas supply to the ON position. Turn on the electrical supply to the water heater. Inside the unit there is a switch marked WATER HEATER. Turn the

HVAC, Appliances  
& Accessories

switch to the ON position. There will be a 15 second purge before the unit will spark. If the burner does not light on the first try, there will automatically be two more tries for ignition before it will lock out. Each ignition cycle will have a 15 second purge. If lock out occurs before the main burner lights, turn the switch to OFF, wait five seconds and turn the switch to ON again. This will re-start the ignition cycle. The initial start-up of the water heater may require several ignition cycles before all of the air is purged from the gas lines.

#### **WARNING**

Do not light the water heater until it is filled with water. There is a switch on the exterior of the water heater labeled Electric. This switch must be in the ON position for the water heater to work in the electric mode.

### **Water Heater Storage**

When storing your unit for the winter months, the water heater must be drained to prevent damage from freezing. The first step is to turn off all electrical power and Propane gas going to the water heater. The water pump must also be turned off. Open both the hot and cold water faucets to drain the lines. Open the drain on the water heater. Drain the entire water system. When preparing the unit for use after it has been stored, make certain the water system, including the water heater has been filled before re-lighting the water heater. Failure to fill the water heater before lighting may damage the water heater and void the warranty.

### **Pressure Relief Valve**

The temperature and pressure relief valve is designed to open if the temperature of the water within the heater reaches 210 F, or if the water pressure in the heater reaches 150 pounds. Recreational vehicle water systems are closed systems and during the water heating cycle the pressure build-up in the water system may reach 150 pounds. When this pressure is reached, the pressure relief valve will open and water will drip from the valve. This dripping will continue until the pressure is reduced to below 150 pounds, and the valve closes. This condition is normal and does not indicate a defective relief valve.

**WARNING**

Do not plug the relief valve under any circumstances.

**WARNING**

Do not store any combustible materials or liquids near or adjacent to the water heater.

**Washer/Dryer (Optional)**

The preparation for a washer and dryer is a standard feature on this product. However, the installation of a two piece washer and dryer is part of the various option packages available. The washer and dryers used by Newmar function as those in a home, operating on 120 volt electricity. For more detailed information on the operating instructions, read the appliance owner's manual in the Owner's Information Package.

**CAUTION**

The gray tank valve must be in the open position when operating the washing machine.

**Ceiling Fan**

In the living room area you may find a ceiling fan. This operates on 120 volt electricity. The fans three speeds (low, medium and high) can move air in two directions, up and down. Moving the air up in the summer months, the fan will help circulate the cool air from the air conditioner. By moving the air down, the fan will help circulate the warm air from the furnace in the winter months.

Chapter **4**

**CABINETS, FURNITURE & INTERIOR  
FEATURES**

**CABINETS .....3**

**FURNITURE.....4**

    Living Room Area ..... 4

    Optional Hide-A-Bed with Air Mattress ..... 4

    Bedroom Area ..... 5

**INTERIOR FEATURES .....5**

    Flooring..... 5

    Ceiling ..... 5

    Window Treatment..... 5

    Loft Bed Access Ladder..... 6





## CABINETS

The cabinetry in your RV is constructed on-site at the Newmar Production Facility. Oak hardwood raised panel doors are standard throughout the unit. Brass or brushed door and drawer handles give the interior an added touch of elegance. The standard cabinets in your unit are finished in oak vinyl veneer. Your unit may be equipped with the optional hardwood cabinetry in a variety of finishes. Your cabinetry was designed with function and convenience in mind, and was built to exacting standards by modern craftsmen.

The silverware drawer may contain a molded silverware divider tray for added storage convenience.

Storage is an important factor to all RV owners. Keeping this in mind, the cabinetry is structured to provide as much storage as possible. In the bedroom, the bed platform lifts to provide an additional, convenient storage area. A strap is provided to help raise the bed. Once the bed platform is lifted, it is held open by pressurized struts to allow hands-free access.

A countertop with a color coordinated edge is installed in the kitchen. To clean, wipe with a damp cloth and for dried on spots or rings, wipe with a damp cloth and a mild liquid soap. Strong chemicals and solvents may damage the surface and should be wiped up immediately, then rinse the surface with water.

Avoid cutting directly on the countertop surface, avoid excessive heat, and keep harmful chemicals away to avoid countertop surface damage. The cabinetry throughout the unit can be cleaned with commercial furniture cleaner or polish. As with any wood product, do not saturate the cabinets with water or any other liquid. Be certain to wipe up spills as they occur to avoid staining.

The drawer directly in front of the kitchen and lavatory sink does not pull out, but rather flips down. This provides a storage tray for dish cloths, scouring pads, washcloths, etc. Metal drawer guides may be on all of the drawers throughout the unit. These guides provide a smooth opening and closing of the drawers. To open a drawer, lift up slightly and pull open. This



mechanism will prevent the drawers from unintended opening while traveling.

## **FURNITURE**

### **Living Room Area**

A standard feature in the kitchen area is the free-standing dinette. This includes a hardwood table and four chairs. The chair seats and backs are designed with a coordinating upholstery fabric to match your decor. Optional is a combination desk/dinette table with two folding chairs and two fixed chairs or a hidden leaf dinette table.

Depending upon the floor plan of your unit, the standard sofa will either be a Magic Bed or Hide-A-Bed sleeper sofa. As an option, an air mattress may be included for the Hide-A-Bed sofa. The magic bed sofa converts into a sleeping area by holding and pulling up on the bottom cushion while pushing down on the back cushion. Before converting the hide-a-bed sofa, extend the slide out to make room for the bed. Once the room is extended, remove all of the seat cushions. Next, take hold of the handle on the bed mechanism and pull to extend. Expand the bed to the fully-open position by unfolding the foot portion of the bed. All of the sofas are upholstered in decor-matching fabric. If you have any questions regarding the warranty on this sofa, contact the sofa manufacturer.

Depending on the floorplan of your unit, one or two large recliners may be installed in the living room. Optional are one or two leather/vinyl large recliners or one two small leather/vinyl recliners. One or two leather/vinyl recliners with an ottoman, a sofa coffee table, or a chair end table may also be optional features in the living room.

### **Optional Hide-A-Bed with Air Mattress**

Your unit may be equipped with the optional “Hide-A-Bed” sleeper sofa. The following steps are used to operate the bed.

To open the bed and inflate the mattress:

- 1.** Remove the seat cushions and pillows from the sofa.
- 2.** Grab the handle on the bed frame and pull the bed assembly up and out, then unfold the bed frame to full extension.

To store the “Hide-A-Bed”, the steps are:

3. Fold the bed frame back into the sofa base. This should be done in a slow, steady manner allowing the mattress to fold into the bed framework.
4. Replace the cushions and pillows.

### **Bedroom Area**

The standard mattress in the bedroom is a 60" x 80" queen size bed.

A luxurious pillow top mattress may be an option in lieu of the standard mattress. For best results, it is recommended that the bedspread be DRY CLEANED ONLY.

On each side of the bed you may find wardrobe closets. Lights may be installed in these closets for your convenience.

## **INTERIOR FEATURES**

### **Flooring**

The floor covering throughout the living room and bedroom of the unit is nylon tufted cut loop carpeting. In the Owner’s Information Package you will find literature supplied by the carpet manufacturer. This information will be helpful in maintaining and extending the life of the carpet. Please refer to this information for the carpet care and cleaning instructions. The flooring throughout the kitchen and bath area is simulated plank. Ceramic floor tile or 12”marble-like tiles are optional throughout these areas. Simple vacuuming is all that is necessary to remove loose dirt and debris for everyday cleaning. Mop occasionally, using a minimal amount of water. For more thorough cleaning, mop with a mixture of soap-free household cleaner and water (vinegar and ammonia both work well). Be careful not to saturate the floor with water; this could damage the flooring. Abrasive cleansers and scouring pads can scratch and damage the surface also.

### **Ceiling**

The ceiling in this unit is covered with a padded vinyl ceiling headliner. The recommended cleaning instructions is to use a soft cloth and a mild detergent.

### **Window Treatment**

The window treatment throughout this unit, except in the kitchen, is pleated day/night window shades and lambrequins. These shades have two sections. The first section visible when closing the shade is the “DAY” section. This

material is translucent. Sunlight passes easily through the material into the unit. The second visible section is the “NIGHT” section. This material is a heavier, more opaque material. Very little to no light passes through it. It is generally used in the evening or when more privacy is desired. If any curtains are installed in this unit, cleaning instructions are DRY CLEAN ONLY. Water-based products are not recommended for cleaning fabrics. Water-based products may cause excessive shrinkage or fading. The kitchen window is equipped with a mini-blind.

### Loft Bed Access Ladder

The ladder used to access the loft bed overlooking the living room / kitchen area is hinged to permit storage while operating the slide out, or to extend while the unit is in use for access to the loft bed. The ladder is hinged at the top, and swings in and out at the bottom. It is CRITICAL that the ladder be in the “stored” position prior to operating the slide out room, whether retracting or extending. To move the ladder, lift it gently from the floor and move the bottom (feet) in or out. Note that when the ladder is in the “stored” (in) position, the feet should rest inside the wall trim at the bottom of the ladder opening to keep it secure in transit.



#### **IMPORTANT**

Be sure to check the ladder to make sure it is out of the path of slide out travel before operating the slide out room. Failure to do so can damage the ladder and slide out, as well as cause injury to anyone its path of motion.

Chapter **5**

**ELECTRICAL FEATURES**

Electrical Systems.....3  
    General Information..... 3  
    Breaker Boxes ..... 4  
    Batteries..... 4  
    Battery Inspection & Care ..... 4  
    120 Volt Receptacles ..... 6  
    Ground Fault Circuit Interrupt Receptacle ..... 6  
    Wiring Connector..... 7  
    Generator Prep (Optional)..... 7  
    Generator (Optional)..... 7





## ELECTRICAL SYSTEMS

### WARNING

#### Use of “Adapter” cords with the RV shore power cord.

All Newmar units are manufactured with either a 30 or 50 amp electrical breaker box and electrical system. A unit with a shore power cord that has 3 prongs on it has 30 amp service; if the shore power cord has 4 prongs, it has 50 amp service. To provide the correct amperage into the RV and to assure the operation is as designed, it is important that they be plugged into the correct type of properly grounded receptacle. The receptacle **MUST** be properly grounded to insure safe, proper operation of all electrical components.

**NEWMAR CORPORATION DOES NOT RECOMMEND USE OF “ADAPTER”, “CHEATER”, OR “DOG BONE” STYLE CONNECTORS THAT WILL MODIFY THE EXISTING SHORE POWER CORD TO A DIFFERENT STYLE OF OUTLET. USE OF THIS TYPE OF ADAPTER WILL GREATLY REDUCE THE AMOUNT OF AVAILABLE CURRENT IN THE UNIT, AS WELL AS CREATE THE POTENTIAL FOR ELECTRICAL FAILURE AND / OR FIRE. NEWMAR CORPORATION CANNOT ASSUME LIABILITY FOR FAILURES OCCURING TO THE RV, ITS ELECTRICAL SYSTEM, OR ANY OF ITS COMPONENTS FROM THE USE OF ANY ELECTRICAL ADAPTER.**

### General Information

There are two electrical systems in your coach. They are the 12 volt DC system and the 120 volt AC system. Most standard appliances require 120 volt electricity while the majority of the lighting used in recreation vehicles is powered by 12 volt electricity. The power for the 12 volt system is supplied by the coach batteries. The power for the 120 volt system is supplied by the power cord when the unit is connected to an outside power source or by the generator, if so equipped. When connected to shore power, the standard 55 amp power converter will automatically charge the batteries as well as convert 120 volts into 12 volts. To connect the unit to 120 volt shore power, first make sure all of the breakers are in the off position. This is done to avoid a power surge. Unwind the power cord from the electrical compartment. The standard electrical service for fifth wheels is 50 amps. Check to make sure the pins in the outlet are oriented correctly, that they match the power cable, and that they are in good condition. If there is a circuit breaker switch at the plug, it should

be turned OFF before making the connection. Insert the plug completely into the outlet and turn the circuit breaker on. Close, and lock the electrical compartment door to keep the contents clean, dry, and secure. Close the cover on the power box, if equipped, to avoid an unintended disconnection, and to keep contents clean. Switch the main breaker to the ON position. The 120 volt system will energize all 120 volt circuits and outlets when the main breaker is turned on.

### **Breaker Boxes**

The 120 volt and 12 volt breaker boxes are generally located in the cabinet above the toilet, but the location varies with each floorplan. Circuit breakers and fuses are installed to protect the electrical system from overloading. Do not attempt to change the circuitry or add appliances yourself. Please consult an authorized Newmar Service Center.

### **Batteries**

Any 12 volt battery you installed in your unit is warranted by the battery manufacturer. Two six volt batteries (wired in series) may be installed instead for longer life. They are used to operate the 12 volt items in the unit. The batteries also operate the water heater's electronic ignition, landing jacks, etc. In-line breakers protecting these circuits are found near the batteries. If the tow vehicle is equipped with a charge line, the tow vehicle's electrical system will charge the coach batteries while in transit. The power converter, if installed, automatically charges the coach batteries when the unit is connected to a 120 volt outside power source.

### **Battery Inspection & Care**

Remember, when a battery is not used for an extended period of time, it may lose its charge. Periodic charging of the battery during storage of the unit will increase the life of the battery. Check the external condition of the battery periodically. Look for cracks in the cover and case. Check the vent plugs and replace them if they are cracked or broken. Keep the battery clean.

Accumulations of acid film and dirt may permit current flow between the terminals, which could drain the battery. To clean, wash the battery with a diluted solution of baking soda and water to neutralize any acid present. Rinse thoroughly with clean water. Foaming around the terminals or on top of the



battery is a sign that acid is being neutralized. Avoid getting the baking soda solution in the battery.

Secure all vent caps. Dry the battery cables and terminals. Do not use grease on the bare metal inside the cable terminals to prevent corrosion. Grease can act as an insulator. Electricity will not flow through it. A plastic ignition spray will protect the terminals after they have been cleaned. When storing the unit for a short period of time, the battery should be disconnected from the coach to prevent draining. As an option, your unit may be equipped with a battery disconnect switch. Located in the bathroom cabinetry, you can disconnect the batteries from the house circuitry by simply turning the switch to the “OFF” or “DISCONNECT” position. To restore power, return the switch to the “CONNECT” or “ON” position. Also, use the battery disconnect switch any time you are going to remove the batteries to help prevent possible damage to the DC powered components in the unit from surges or poor initial contact. When not using your unit for an extended period of time, the battery should be removed and stored in a warm place. Mark the cables, positive and negative, for easy identification. Batteries are not to be stored on concrete floors. The battery may require periodic charging during storage. If the unit is to be stored for a long period of time, it is recommended that all the batteries inside the unit be removed from clocks, radios, smoke alarms, etc. This will prevent unnecessary drain and corrosion of the batteries. The coach battery is a deep cycle RV/marine battery. This type of battery consumes water and must be filled periodically. Please be sure to check the battery water level on a regular basis, particularly after extended periods of heavy use where frequent charging can cause more boiling of the fluid in the battery. Battery electrolyte or distilled water can be used to fill batteries in most cases, but be certain to consult the owner’s manual supplied by the battery manufacturer for specifics regarding the batteries in your unit.

**WARNING**

Do not allow the battery fluid to contact your skin, eyes, fabric, or painted surfaces. The fluid could cause serious personal injury or property damage. Wear eye protection when working with any battery.

**CAUTION**

Disconnect the 120 volt electrical power cord and the negative terminal from the coach batteries before working on the electrical system.

**WARNING**

Remove rings, metal watch bands and other metal jewelry before working around batteries. Use caution when using metal tools. If a tool contacts a battery terminal or metal connected to it, a short circuit could occur which could cause personal injury, explosion or fire.

### 120 Volt Receptacles

For your convenience, there are 120 volt receptacles located throughout the interior of the unit. There may also be exterior outlets located on the doorside of the coach. These receptacles require the three-pin plugs that provide proper grounding to protect you from electrical shock. Do not use an adapter, cheater, or extension cord that breaks the continuity of the ground circuit to the ground pin. Never remove the ground pin from a plug in order to connect it to a two pronged ungrounded outlet. Never operate the camping vehicle with an electrical short. An electrical short may cause the exterior of the unit to shock you when touched. If you feel even the slightest shock, disconnect the unit from the 120 volt power source. It is usually a break in the grounding circuit. The grounding circuit must be continuous from the frame to the distribution panel, to the power cord, to the earth ground.

### Ground Fault Circuit Interrupt Receptacle

The 120 volt electrical outlets in the kitchen and bath area are ground fault circuit interrupt (GFCI) protected receptacles. The electrical outlets located in the slide out may be wired through the kitchen GFCI. The exterior electrical outlets are wired through the bathroom GFCI. If an item plugged into a slide out or outside receptacle is not working, check for a tripped GFCI in the kitchen or bathroom. These outlets protect the user from ground faults between a hot wire and ground. The GFCI will not reduce the shock hazard if the short is between a neutral and hot wire, or two hot load wires. The GFCI should be tested at least once a month. The 120 volt electrical system must be on in order to test the GFCI. The reset button needs to be pushed in all of the way before

starting the test. Push the test button. This will cause the reset button to pop out which means that the protected circuits have been disconnected. Push the reset button back in until a click is heard. This will reactivate the protected circuit. If the GFCI is working properly the reset button will remain in the IN position.

### Wiring Connector

The wiring connector installed on all Newmar towable units is the standard seven pin connector. The 12 volt or 6 volt battery in the tow vehicle supplies power to the trailer's electric brakes, tail lights, brake lights, turn lights, etc. through this connector. Below is the diagram of the tow plug. This view is looking into the tow vehicle receptacle. As stated above, this is a standard seven pin pigtail.

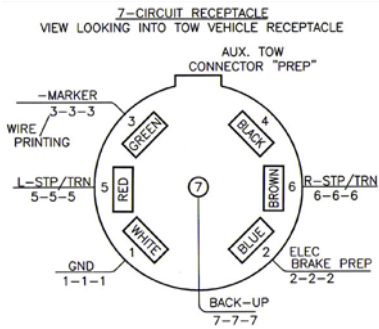

- Left Turn Signal . . . . .Red
- Right Turn Signal . . . . .Brown
- Clearance . . . . .Green
- Ground . . . . .White
- Back Up Lights . . . . .Yellow
- Charge . . . . .Black
- Brakes . . . . .Blue

### Generator Prep (Optional)

This option must be installed before the generator option. With this option, the remote start wire is installed in the unit along with the automatic change over switch and carbon monoxide detector.

### Generator (Optional)

As an option, a generator may be added. With the installation of the generator, your unit may have both a 50 amp automatic changeover switch and an additional battery. When the generator is running, it will produce 120 volt power. This will supply electricity to the appliances and 120 volt lights in the unit when not connected to shore power. There is an hour meter on the generator. The meter tracks the number of hours the generator has been

Electrical Features

running. This information is important for routine maintenance. For further instructions on the generator operation and maintenance, please refer to the generator manufacturer operator's manual located in the Owner's Information Package.

## Chapter 6

# EXTERIOR FEATURES

<b>EXTERIOR FEATURES .....</b>	<b>3</b>
Exterior Sides .....	3
Security Lights (Optional) .....	3
Jacks .....	3
Stabilizer Jacks .....	4
Electric Stabilizer Jacks (Optional) .....	4
Roof .....	5
Entrance Porch (Manual) .....	5
Power Porch (Optional) ....	Error! Bookmark not defined.
Windows .....	5
Doors .....	6
Vents .....	6
<b>AWNINGS .....</b>	<b>6</b>
Side Awning .....	6
Extending .....	6
Retracting .....	7
Window Awning (Optional) .....	8
Extending .....	8
Retracting .....	8
<b>GARAGE AREA .....</b>	<b>8</b>
Rear Cargo / Ramp Door .....	9
Fueling Station .....	10
Cargo Area Bunk Beds (optional) .....	12
Cargo Ramp / Door Screen .....	13
Cargo Bay Work Station .....	14
Cargo Bay Entertainment Center .....	14



## EXTERIOR FEATURES

### Exterior Sides

The exterior sides of this unit are constructed of gel-coated fiberglass. To add to this feature, the end caps are also gel-coated fiberglass. Clean the fiberglass material with a mild cleanser and warm water. Use only soft cloths. Using stiff bristle brushes may cause scratches in the fiberglass surface. Please note, Newmar is NOT responsible for weathering/oxidation of gel-coated surfaces.

### Security Lights (Optional)

Optional are exterior security lights. One or two may be installed on each side of the coach for added protection. If installed, the switch for these lights may be located inside the front entrance door.

### Jacks

Fifth wheel units may be equipped with 12 volt electrical jacks. As an option, hydraulic leveling jacks with touch panel control may be installed. Before using the jacks, read and closely follow the operation instructions provided by the jack manufacturer. To lift the unit for uncoupling, drop the pad tube by removing the lock pin. Re-pin the hole that places the foot pad closest to the ground to compensate for variations in the terrain between the jacks. Push the toggle switch to the DOWN position and hold until the jack raises the unit to the desired height.

To raise the jacks after coupling, push the toggle switch to the UP position and hold until the jacks are fully retracted. Release the toggle switch as the lock pin in the inner ram tube nears the end of the outside tube to avoid unnecessary wear on the motor clutch. Remove the lock pins and raise the pad tubes, re-pinning them in the highest possible position.

#### CAUTION

When the jacks reach their maximum extended or retracted length or maximum load, you will hear a clicking noise. This is the slip clutch built into the motor to prevent jack over-extension or retraction. Release the toggle switch as soon as you hear the clicking. Continued operation with the clutch slipping can damage the jacks.

**CAUTION**

Before raising the jacks, make sure the hitch is securely latched by applying the trailer brakes and slowly pulling the tow vehicle forward. The unit should prevent the tow vehicle from moving.

These jacks can be operated manually, if necessary. Insert the hand crank into the alignment tube until the end engages with the crank shaft. Turn the crank handle counter clockwise to raise the trailer. Remove and store the crank handle. To raise the jacks after coupling, rotate the crank handle clockwise. Retract as far as possible with the crank handle, then remove the lock pin and raise the pad tube and re-pin it in the highest possible position. Please refer to the jack manufacturer operation instructions for further assistance. The snaps for the fifth wheel jacks may be featured on this model.

**CAUTION**

Before moving the trailer, crank up the stabilizer jacks to the fully closed position. Tighten 1/4 turn to secure the jacks in the travel position. This will help prevent the stabilizers from working open due to road vibration. Do not use stabilizer jacks to lift the unit.

**Stabilizer Jacks**

Fifth wheel units may also be equipped with one pair of stabilizer jacks. As an option, an extra pair of stabilizer jacks or power twin jacks may be installed. The operation of the stabilizer jack is fairly simple. First park the vehicle on level ground. Block the wheels using tire chocks to prevent the unit from moving. Level the front and the back of the unit using the tongue jack or landing gear. Crank the stabilizers down on the low side first, this will bring the trailer to a fine level position. Re-tighten the stabilizers on the low side of the unit, if necessary. Do not use stabilizer jacks to lift the unit.

**Electric Stabilizer Jacks (Optional)**

In place of the manual stabilizer jacks, an electric stabilizer jack assembly may be optioned. For further instructions on the operation of these, refer to the manufacturer operator s manual in the Owner s Information Packet.



## Roof

This unit is manufactured with a 7mm rubber roof material. Optional is a gel-coated fiberglass roof and top wrap. Proper care and routine maintenance of your roof is necessary for trouble-free performance. On this model, the ladder is an optional feature. The ladder will assist you in gaining access to the roof for routine inspections and maintenance.

## Entrance Porch (Manual)

Your unit is equipped with a manually operated porch at the entrance steps. This porch provides a standing area at the entrance door, and incorporates the entrance steps into the mechanism as well.

To release the porch assembly, locate and pull the release handle on the step assembly. The porch assembly will release from its stored position. Pull the assembly up and out until it latches into the open position. Swing the handle up and drop it into the locked position for use when entering and exiting the unit. To extend the step, first release the locking latch. Once the latch is released, pull the step pivot section out and down by the step cross member bar. Next, release the second step by pulling the step up and straight outward until it locks into position. Then pivot the third and final step out and down. For retracting the step, reverse the procedure. Keep all step pivot points lubricated with a quality grease-based spray lubricant for smooth operation.

### CAUTION

If the vehicle is towed with the porch or steps in the extended position, there is the possibility of causing major damage to both the step and the vehicle.

### WARNING

Be careful not to get any fingers or clothing near the pivot action of the step.

## Windows

In the bedroom of the unit, one window will be marked EXIT. This window is an emergency escape, or egress, window. To open in case of an emergency, lift the red handles at the bottom of the window and push out. The windows installed in the fifth wheel units may be the radius torque, tinted safety glass

style. These windows are also referred to as jalousie windows. Optional may be the double pane tinted safety glass windows.

## **Doors**

The entrance door to fifth wheels is a radius door equipped with a dead bolt lock and lighted steps for added security. The door can be held open with the door stop. With the door open, simply lift the “T” section on the door and place it in the holder on the exterior sidewall of the unit. Next to the entrance door, a lighted, acrylic assist handle may be optional. If installed, this handle will assist anyone entering the unit.

## **Vents**

In the kitchen area, an optional feature may be the 12 volt vent equipped with a rain sensor on the roof hood. Anytime the vent is open and it senses rain, it will automatically close. The vent is controlled by the wall thermostat. Once powered ON and the desired temperature is selected, the vent will run until the preset temperature is reached. When the temperature is reached, the vent will automatically shut off. Do not leave the fan in active mode while the unit is in storage or unattended for long periods of time. High winds or other unusual conditions or obstructions may prevent the vent from closing resulting in leakage, which could cause serious damage.

In the bath area a vent may be installed that operates on 12 volt electricity. This vent will be controlled by an on/off switch on the wall. Optional may be a vent with a rain sensor. If this is installed, it would be in place of the standard vent and located above the tub/shower.

A skylight may be an optional feature in the bathroom. If installed, it may be located above the tub/shower.

## **AWNINGS**

### **Side Awning**

A side awning may be a standard feature on your coach. To operate, follow these instructions:

### **Extending**

1. Loosen the black adjustment lock knob behind each main arm. Flip the travel lock latches up.

- 2.** Using the provided pull rod, reach up and pull the locking lever forward or down to release the awning.
- 3.** Hook the rod into the loop of the pull strap and pull the awning all the way out.
- 4.** Slide one rafter arm up until it snaps into place. Push down on the main arm to remove slack from the fabric, and tighten the black adjustment knob. Repeat on other side.
- 5.** Slide the pull strap to the right end of the roller and wrap it around the main arm.
- 6.** Pull up on the lift handle and raise the arm assembly to the desired height. Swing handle in, and allow the lock button to snap into one of the holes. Repeat on the other side.
- 7.** Press the release lever at the bottom end of one main arm, pull the arm assembly outward to a vertical position, and readjust height. Repeat on other side. Drive provided stakes through holes of each patio foot into the ground.
- 8.** During rain, lower one end to allow water to flow off.

### **Retracting**

- 1.** Pull the stakes from the ground, swing the arm toward the vehicle, and snap the patio foot into the bracket. Repeat on the other side.
- 2.** Raise the lift handle to release the lock button. Lower the main arm to the stop plug. Swing the handle in to engage the lock button in a hole. Repeat on other side.
- 3.** Loosen black adjustment knob, lift slider catch, and slide the rafter arm down to the bottom of the main arm. Leave the black adjustment knob loose. Repeat on other side.
- 4.** Grasp the pull strap and pull toward you. Flip the locking lever to the ROLL UP position. Hold the awning in the down position until you are ready to roll up the awning.
- 5.** Slide the pull strap to the center and using it to control speed, allow the awning to return to the side of the vehicle. Allow the strap to wind diagonally to prevent a bulge in the fabric.
- 6.** Tighten the black adjustment knob and flip the travel lock latch down. Repeat on other side.

The awning is now ready for travel.

**CAUTION**

The awning will try to roll up as soon as the locking lever is flipped to the ROLL UP position.

**CAUTION**

Whenever heavy or prolonged rain or wind is anticipated, or you will leave the awning unattended, it is best to close the awning. Damage as a result of weather is not covered by warranty.

### Window Awning (Optional)

A window awning may be an optional feature on fifth wheels. To operate these, use the following instructions:

#### Extending

1. Grasp the loop on the pull strap and pull down to extend the awning. Then hook the loop onto the window strap hanger.

#### Retracting

1. Remove loop on the pull strap from the window strap hanger.
2. Slowly allow the awning to roll back to the closed position by feeding the pull strap upwards and diagonally. This prevents the strap from building up and creating a bulge in the fabric.
3. The window awning is now ready for travel with no further locking required.

**CAUTION**

Do not release the strap as the window awning is under tension and may snap back against the vehicle.

## GARAGE AREA

The garage area of your X-Aire is designed to provide you with convenient storage and access to the cargo you want to carry. It incorporates a number of safety and convenience features, such as rubberized flooring material for better traction and ease of cleaning, ties downs to secure your cargo for transit, and handy storage and work areas.

## IMPORTANT

There are a variety of informational and safety labels located in and around the garage area of your X-Aire. IT IS CRITICAL THAT ALL OF THESE LABELS BE READ AND UNDERSTOOD PRIOR TO USING THE UNIT. Please take the time to make sure you and all who will use this unit are familiar with its unique systems and their safe operation before using your X-Aire.

### Rear Cargo / Ramp Door

The Rear Cargo / Ramp Door is designed to allow easy access for loading and unloading of cargo into the garage area of your X-Aire. The door features a hydraulic dampening system that allows one person to raise or lower the ramp door.

To open the door, locate the handle inside the horizontal trim on the rear door. The handle is located in an opening in bottom of the trim approximately mid-door. It incorporates a key lock so you can secure your cargo by locking the release handle in place, preventing access to the garage area. Be sure the lock is unlocked before attempting to open the rear cargo door.

On top of the handle is a release trigger. Wrap your hand around the pull handle, and squeeze the release trigger with your finger.

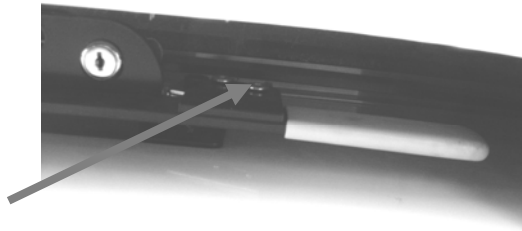

With the trigger pulled, the handle will swing down, releasing the latching mechanism for the rear cargo door (pressing on the door may release some pressure on the latching mechanism to allow the handle to swing down

more easily).

Once the release handle has been pulled down fully, the cargo door / ramp will begin to swing down; after opening a few feet, the hydraulic assist system will catch the door and allow you to lower it gently the rest of the way to the ground.





To complete the lowering process, be sure to rotate the hinged ramp cover at the bottom of the door to bridge the gap between the cargo bay floor and the ramp / door. This allows for smooth transition as items are loaded up and down the ramp into the cargo bay. Always use caution when loading and unloading cargo.

#### **CAUTION**

The cargo bay and loading ramp of the X-Aire are rated at 2500 lbs. of loading and carrying capacity. DO NOT exceed this capacity when loading and unloading the cargo bay, or when traveling with cargo in the bay.

#### **WARNING**

Be sure to keep hands, fingers, and other body parts, as well as clothing clear of the loading ramp / cargo door and its associated moving parts when opening or closing it. Failure to do so could result in bodily injury and / or damage to the door and unit.

To close the ramp / door, reverse the opening process, starting with rotating the hinged ramp cover back into the stored position, then swing the cargo door / ramp back into the upright position. Once it is fully retracted, rotate the locking arm back up into its stored and locked position, making sure it latches securely.

#### **Fueling Station**

Among the unique features of your X-Aire unit is the “Fueling Station” located in a rear “basement: storage compartment. This “Fueling Station” features a fuel tank with gauge, a conventional fuel fill intake tube for filling the tank,

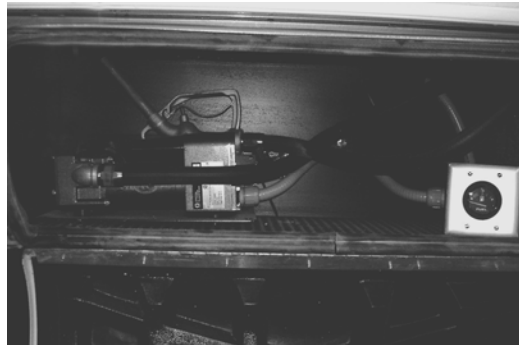



an electric pump, and a fueling nozzle for dispensing the fuel. The switch for the fuel pump is inside the garage area, and is labeled accordingly.

### WARNING

READ AND UNDERSTAND THE COMPLETE OPERATING INSTRUCTIONS IN YOUR UNIT PRIOR TO OPERATING THE FUELING SYSTEM, OR ANY OTHER ACCESSORIES ASSOCIATED WITH THIS SPECIAL FLOORPLAN. FAILURE TO DO SO CAN LEAD TO DAMAGE, SEVERE INJURY, AND DEATH. Be sure to attach the bonding jumper wire to the vehicle being fueled to help lessen any potential static discharge that may occur during the fueling process. Be sure all possible sources of ignition are removed from the area or extinguished, and **NEVER leave a fueling vehicle unattended as the system will NOT shut off automatically when full.**

## Using the Fueling Station

To fuel a vehicle using the Fueling Station:

- 1) Make sure all possible sources of ignition are removed from the area or extinguished.
- 2) Attach the “bonding jumper wire” to the vehicle to be fueled.
- 3) Place the nozzle for the Fueling Station in the fuel fill of the vehicle being serviced.
- 4) Turn the fuel pump on (via the switch in the garage) and dispense the desired amount of fuel into the vehicle being serviced.
- 5) Turn the fuel pump off.
- 6) Remove the nozzle from the fuel fill. Replace the cap on the fuel fill on the vehicle being serviced. Place the nozzle back in the Fueling Station compartment.

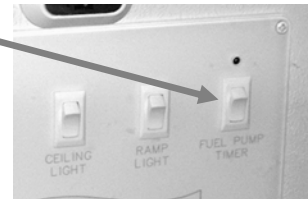

7) Disconnect the bonding jumper wire, and return it to the Fueling Station compartment.

### IMPORTANT

Any spilled fuel should be addressed immediately. Cleaning the spill will be relative to the size of the spill, and the conditions under which it occurs. Each state has its own rules and regulations regarding addressing fuel spills. Be aware of them where you travel, and take extreme care when fueling vehicles to insure safe, fun travels and use of your RV.

### WARNING

**Use ONLY unleaded gasoline in the Fueling Station.** Use of other fuels, including diesel, nitro methane, kerosene, or other unusual or performance fuels may lead to damage or failure of the pump and associated hoses, nozzle, and tank. Such damage or failure may present the potential for fire, personal injury, or death.

### Cargo Area Bunk Beds (optional)

Your unit may have optional bunk beds installed in the cargo bay / garage area. They raise and lower electrically, and feature a lower bunk that folds for additional seating when cargo is not being carried in the garage area. The bunk beds are raised and lowered via the switch located on the door side of the garage area wall. Rocking the switch up raises the beds, and down lowers them.

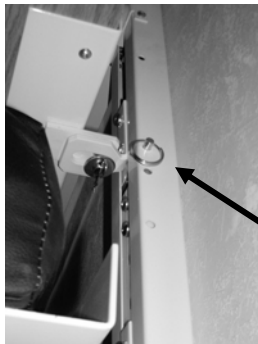
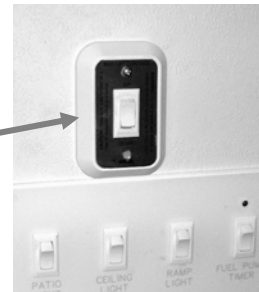

To fold the lower bunk to use as a sofa, begin by raising the bunk beds to their highest position. Once the bunks are completely raised, use the four pins provided with the unit to lock the top bunk into position (install one pin in each of the four lift posts on the wall). These pins will lock the upper bunk in the highest position. Once the upper bunk is secure in this



position, you can lower the bottom bunk using the power lift / lower mechanism.

When the lower bunk has reached the bottom of its travel, reach in between the cushions to lift the back portion upright to convert the bunk into a sofa. Lift the back portion until it “clicks” into place.



To lower the seat backs, returning the bunk to a sleeping surface, pull the seat back toward you until it clicks; the seat back will release and you can lower it to make a sleeping surface.

#### **WARNING**

**DO NOT use the bunk beds as a lifting device. DO NOT operate the bunk beds with anything on them. Attempting to do so could result in failure of the bed, the lift mechanism, or both, and could result in damage to the RV, and injury or death to anyone nearby. The rear cargo area bunk beds are designed for temporary use and should not be occupied while in transit. They should also not be occupied while any vehicles are stored in the cargo bay area.**

#### **Cargo Ramp / Door Screen (optional)**

The Cargo Ramp / Door features an optional pull down mesh screen that allows you to leave the ramp lowered for ventilation and comfort while keeping insects and other pests out of the cargo bay / garage area. Simply grasp the handle in the middle of the screen and pull it downwards until it latches on the ends to the catch

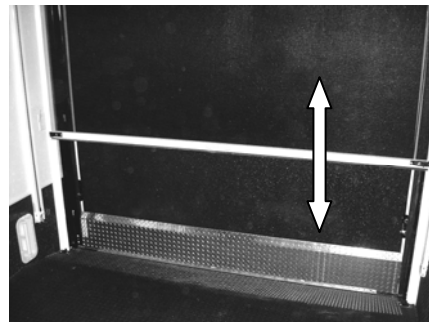

mechanisms on the floor. To retract it, hold the handle and release the latches on the ends. Spring tension will pull the screen up, so be sure to hold the handle securely to prevent sudden retraction that could potentially damage the accessory.

### Cargo Bay Work Station

As a standard feature, your X-Aire is equipped with a folding work station in the garage area. It stores flush to the wall for travel, and easily folds down to create a work space. To open the work station, pull the release pin located on the left side and swing the work surface downward.

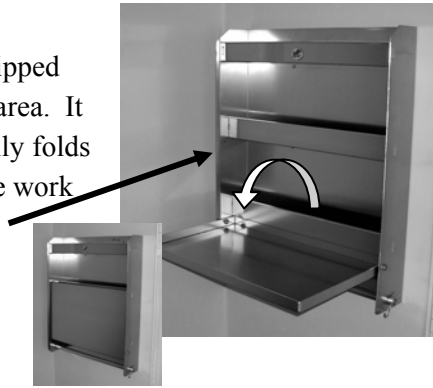

### Cargo Bay Entertainment Center

Your X-Aire may have an Entertainment Center located in the Garage / Cargo area. This entertainment center incorporates a television and stereo. The TV can be used to tune local channels via the antennae (note that it is not



connected to the DVD player inside the unit). The AM/FM/CD stereo is connected to 4 speakers; two in the garage area, and two located on the door side of the unit under the awning. They can be turned on and off in pairs using the switch located inside the cabinet door above the radio, allowing you to listen to interior speakers, exterior speakers, or both. The radio can be operated by the controls on the face, or by the wired remote located in the “Super Storage” basement compartment at the door side front of the unit.

Chapter **7**

**PLUMBING & BATH FEATURES**

**FRESH WATER SYSTEM .....3**

- Kitchen Sink ..... 3
- Bath Sink, Shower & Accessories..... 3
- Monitor Panel ..... 3
- Monitor Panel Calibration ..... 3
- Water Pump ..... 4
- City Water Hook-Up ..... 5
- Fresh Water Tank Fill..... 5
- Sanitizing ..... 5
- Water Filtration System..... 7
- Drink Dispenser with Water Filter ..... 8
- Water Heater By-Pass System..... 8
- Fresh Water Lines ..... 9

**WASTE WATER SYSTEM.....9**

- General Information..... 9
- Toilet ..... 10
- P-Traps..... 10
- Black Water Holding Tank..... 10
- Gray Water Holding Tank ..... 11
- Waste Water Disposal ..... 11
- Camping with Sewer Hook-Up..... 12
- No Fuss Flush ..... 13





## FRESH WATER SYSTEM

### Kitchen Sink

The kitchen sink installed in your unit may be an acrylic, double-bowl sink equipped with two sink covers to provide additional counter space when the sink is not in use. Cleaning care consists of washing with mild detergents and a soft cloth. Avoid using S.O.S. type cleaning pads because they may scratch the surface. The faucet in the kitchen may be a single-handle faucet equipped with a pullout spout.

### Bath Sink, Shower & Accessories

The sink in the bathroom may be a porcelain sink. Use care when cleaning to avoid scratching the surface. The brass bathroom accessories in fifth wheel units include a towel bar, tissue holder, towel ring, and robe hook. The shower installed is a fiberglass combination tub/shower with a glass shower door. An assist handle may be installed in the tub/shower as an optional feature.

### Monitor Panel

The monitor panel allows you to check the approximate levels in the fresh, gray, and black water holding tanks, and the battery condition. The monitor panel is generally located in the bathroom. Simply press the button of the item to check its status. The empty indicator light will always light when the button is pressed. If the tank is full, all of the lights will be on. Lights are sequential, and indicate the level in approximately 1/4 tank increments. For example: If the tank selected is approximately 1/2-full, then the indicator lights E, 1/4, and 1/2 will be lit. On the right hand side of the monitor panel is the water pump switch. This switch controls the power going to the water pump, turning it either on or off.

### Monitor Panel Calibration

The monitor panel comes to you factory calibrated for accuracy and should not need to be adjusted. In the event that the system does not read accurately, then re-calibration may be necessary. The procedure for re-calibration is simple:

1. Fill the tank to be re-calibrated.
2. Using the adjustment tool enclosed in the Owner s Package (or any small flat-bladed screw driver) simultaneously push the button for that tank and rotate the adjustment screw located above the button and behind the face plate counter-clockwise until some of the lights turn off in sequence.

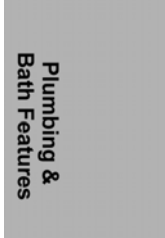

3. Slowly rotate the adjustment screw clockwise until the full light is completely on. Repeat this procedure as necessary for the remaining tanks. The system is now calibrated properly.

### Water Pump

The water pump is self priming and totally automatic, operating on demand whenever water is required. The water pump is used to pressurize the fresh water system when the unit is not connected to city water. To start the pump, follow these instructions:

1. Fill or partially fill the fresh water supply tank.
2. Open the kitchen and bathroom faucets.
3. Turn the water pump switch on and allow the water to fill the water line and the hot water heater.
4. Close each faucet after it delivers a steady stream of water (close the cold water first). Leave the hot water faucets on until they also deliver a steady stream of water. This will ensure that the water heater is filled with water.
5. The water pump should stop running once all faucets are closed.
6. The pump is now ready for automatic operation. The pump will run when a faucet is opened and stop when a faucet is closed.
7. Never allow the pump to run for long periods of time without water in the supply tank. Pump damage or blown fuses may result.

If water doesn't flow when a faucet is turned on while using the demand system, use the following trouble shooting chart.

SITUATION	SOLUTION
<b>Pump running — no water</b>	<ol style="list-style-type: none"> <li>1. Fill tank</li> <li>2. Clear the water line to the pump</li> </ol>
<b>Pump doesn't run</b>	<ol style="list-style-type: none"> <li>1. Check the pump switch</li> <li>2. Check the 12 volt fuses</li> <li>3. Check the electrical connections</li> <li>4. Check the battery</li> </ol>

All of the water should be drained from the fresh water system when the unit is not in use for more than one week. For more detailed information regarding the water pump, refer to the water pump manufacturer's brochure in your Owner's Packet.

## City Water Hook-Up

When connecting your unit to city water, be certain to use a water hose manufactured and labeled for potable water. This will ensure that the hose will not alter the taste of the water. To hook the city water supply to the unit, connect one end of the hose to the city water supply. This will usually be a faucet or valve similar to your garden hose valve at home. Turn the city water supply on for a few seconds in order to clear the line. Once the hose has been flushed, turn the supply off. Connect the other end of the hose to the city water connections. Turn on the water supply and open all of the faucets to clear the air from the lines in the unit. Once air pockets have been purged from the water lines and water flows freely, close all of the faucets. The city water supply is under pressure, therefore the water pump is not necessary when connected to city water. Once the city water fill valve is opened, water is supplied to the fresh water system including the hot water heater, faucets, and stool. To disconnect from the city water supply, close the valve and remove the hose from the city water supply. Disconnect the hose from the city water connection and store the hose in the water compartment.

## Fresh Water Tank Fill

The fresh water tank is filled from the city water hook-up. The water supply valve located in the service compartment near the water hook-up determines whether the city water is going through the water system or into the fresh water tank. An additional way to fill the fresh water tank is with the winterizing intake hose placed in a bucket of water. With the water supply valve open, turn on the water pump to fill the tank. Since there is not an automatic shut-off for the fresh water tank fill, check the level from the monitor panel while filling the unit. The excess water will be vented from an overflow vent pipe onto the ground when the tank capacity has been reached. This pipe is installed in the fresh water tank to prevent tank rupture from overfilling. All of the water should be drained from the fresh water system when the unit is not in use for more than one week.

Whenever possible, drain the fresh water tank before traveling. Water in the tank will reduce the carrying capacity of the unit.

## Sanitizing

To assure complete disinfecting of your fresh water system, it is recommended that the following procedure be followed on a new system, on one that has not

been used for a length of time, or one that may have become contaminated. This procedure is also recommended before long periods of storage, such as over the winter months:

- 1.** Drain the fresh water tank by opening the drain valves. There is one valve per water tank. All of the faucets should be in the closed or off position.
- 2.** Prepare a chlorine solution using one gallon of water and 1/4 cup of chlorine bleach (5% sodium hypo-chlorite solution). Prepare enough of the chlorine solution to administer one gallon of solution for every 15 gallons of tank capacity. For sanitizing this unit, prepare 4 1/2 gallons of the chlorine solution. This mixture puts a 50 PPM (parts per million) residual chlorine concentration in the water system that will act as a quick kill dosage for harmful bacteria, viruses and slime forming organisms. Concentrations higher than 50 PPM may damage the water lines and/or tank.
- 3.** Once the fresh water tank is empty, close the drain valves on the water tank.
- 4.** Pump the chlorine solution into the tank. This is done by placing the winterizing hose into the chlorine solution. Close the valve from the fresh water tank to the pump and open the valve from the solution to the pump. Turn the tank fill valve from city water to tank fill. Turn on the water pump until all of the solution is pumped into the fresh water tank.
- 5.** Turn off the water pump. Close the valve to the solution. Open the valve from the tank to the water pump. Fill the water tank with the city water tank fill (or by using the same method as was used to put the sanitizing solution into the tank). Remove the water filter (from the drink dispenser faucet, if installed) and install the by-pass pipe to allow the sanitizing solution access to the faucet. Open each faucet in turn including the kitchen faucet, bath faucet, inside and outside shower, turning on both the hot and cold, and flushing the stool until all of the air has been purged from the pipes and the water runs freely. The entire system will then be filled with the sanitizing solution.
- 6.** Allow the 50 PPM disinfecting solution to stand in the system at least four hours.
- 7.** Drain the system and flush with fresh water. The water system needs to be flushed with clean water repeatedly, if necessary, until there is no chlorine taste or smell left in the system. To remove any excessive chlorine taste or odor that might remain, prepare a solution of one quart vinegar to five gallons of water. Allow this solution to agitate in the tank for several days by vehicle motion. Drain the solution and refill the tank with clean water.



## Water Filtration System

Your unit Kountry Aire was manufactured with a fresh water filtration system. This system uses extruded carbon filter cartridges to remove sediment and certain impurities from the incoming water supply. The filter assembly is located in the basement water compartment.



To replace the filter cartridge, turn off the water supply to the RV (at the city water connection). Unscrew the filter canister by rotating it clockwise. Replacement filter cartridges are available through your Authorized Newmar Dealer; have them order part number 03738.

Insert the new filter cartridge, positioning it so the opening in the bottom of the filter seats on the molded ring at the bottom of the canister. Reattach the canister to the filter housing by rotating the canister in a counter clockwise direction. When replacing the filter, make certain the rubber “O-Ring” seal is properly positioned in its groove in the cartridge housing. An improperly seated or missing seal will cause leakage around the perimeter of the filter housing. Use caution not to over tighten the canister when attaching it back to the housing.

### IMPORTANT

**DO NOT ALLOW WATER TO FREEZE IN THE WATER FILTER CANISTER.** Freezing will crack and permanently damage the filter housing and associated plumbing. **ALWAYS REMOVE THE FILTER CARTRIDGE PRIOR TO WINTERIZATION.** RV Antifreeze will render the filter element unusable.

## Drink Dispenser with Water Filter (Optional)



If this unit is equipped with a water filter, it must be removed before disinfecting the fresh water system. First remove the water filter, and then install the by-pass pipe to allow the sanitizing solution access to the drink dispenser faucet. The water filter is located under the kitchen sink. The filter will remove chlorine, dirt, and other matter. It will also eliminate most phenol (or similar) odors and tastes while delivering sparkling, taste free water for drinking and cooking. The filter is connected only to the cold water line that is attached to the drink faucet. The filter is not guaranteed to remove the tastes and odors of iron and sulfur. To remove these

tastes you will need to chlorinate the water. Replacement filters are available that will filter iron and sulfur. Ask your dealer or RV supply center about acquiring an iron and sulfur filter. If you are traveling in an area where the water has a high iron and sulfur content, then add 1 tablespoon of chlorine bleach to every 10 gallons of water in your tank. This will precipitate the iron or sulfur so that the filter can remove it. If you are at a site where the unit is hooked up to city water, you will not be able to chlorinate the system because the water flows straight to your faucets and not through the fresh water tank. Filters should be changed every 6 - 12 months depending on the quality and quantity of water that is used in your unit.

## Water Heater By-Pass System

The water heater by-pass valve is located at or near the water heater. By closing the water heater supply valve and opening the by-pass valve you can divert water away from the water heater. This is done when winterizing your unit. Using the by-pass will keep antifreeze out of the water heater when winterizing the system.

Before disinfecting the fresh water system, remove the water filter and install the by-pass pipe to allow water access to the drink dispenser faucet, if installed. The water filter is located under the kitchen sink. The filter will remove chlorine, dirt, and other matter. It will also eliminate most phenol (or similar) odors and tastes while delivering sparkling, taste free water for

drinking and cooking. The filter is connected only to the cold water line that is attached to the drink faucet. The filter is not guaranteed to remove the tastes and odors of iron and sulfur. To remove these tastes you will need to chlorinate the water. Replacement filters are available that will filter iron and sulfur. Ask your dealer or RV supply center about acquiring an iron and sulfur filter. If you are traveling in an area where the water has a high iron and sulfur content, then add 1 tablespoon of chlorine bleach to every 10 gallons of water in your tank. This will precipitate the iron or sulfur so that the filter can remove it. If you are at a site where the unit is hooked up to city water, you will not be able to chlorinate the system because the water flows straight to your faucets and not through the fresh water tank. Filters should be changed every 6 - 12 months depending on the quality and quantity of water that is used in your unit.

### **Fresh Water Lines**

Vibration and flexing during traveling can cause pipes and fittings to work loose. Check all of the plumbing connections for leaks on a yearly basis. If the water pump runs when all faucets are turned off, check for a leak. Be sure the drain valves are closed. Connections at the kitchen and bathroom faucets normally seal with hand tightening and a half turn with a wrench. If a fitting leak persists, disconnect it completely and check for mineral deposits or foreign material on the sealing surfaces. Clean the surfaces thoroughly and reinstall the fitting. Take the coach to an authorized service center for repairs if the system continues to leak. Follow the winterizing instructions given in Chapter 14 to reduce the risk of leaks caused by cracks from freezing pipes. Freezing damage can be extensive and expensive.

## **WASTE WATER SYSTEM**

### **General Information**

The waste drainage system was designed to provide adequate and safe storage and/or disposal of waste materials. All of the material used in the making of this system are tested by a nationally recognized testing laboratory. The drainage system uses ABS plastic piping and fittings connected to the sinks, toilet, and holding tanks. This provides for their drainage to an outside termination.

The unit should be reasonably level for best operation of the system. There are two separate waste systems. The gray water system is for waste water from the

sinks and shower. The black water system is generally for sewage waste from the stool. Each tank has its own control valve and both tanks drain through the sewer drain hose.

## Toilet

The stool operates with water from either the fresh water tank with the water pump on or the city water supply. Before using the stool, add water to the bottom of the tank. Refer to the BLACK WATER TANK instructions in this chapter. The stool flushes wastes directly into the black water holding tank. The stool uses high velocity water injection to produce a swirl effect in the bowl. The greatest problem that causes stool solids to build up in the holding tank is lack of liquids. When using your stool, it is wise to fill the stool 3/4 full of water. This will help to wash the solids away from directly below the stool and to ensure complete dumping of the holding tank. Depending upon the model installed, water can be added to the stool bowl by lifting up on the lever. To flush the stool, push down on the lever until water swirls. The stool requires little maintenance. Use an approved non-abrasive cleaner to clean the bowl. Spraying the bowl sealing blade with a silicone spray will retain the original smooth operating condition. Check the complete instruction and trouble shooting guide in the stool manufacturer s owner s manual provided in the Owner s Information Packet.

## P-Traps

Each of the sink drains, the shower drain, and the washing machine drain (if equipped) has a water trap (P-Trap) to prevent holding tank odors from entering the coach. These traps must have water in them in order to work. While traveling, the water may splash out of the sink and shower drains. While stored, the water may evaporate allowing an odor to enter the coach. If this occurs, run water from the faucet into the drain, allowing water to fill the trap.

## Black Water Holding Tank

The black water, or sewage, holding tank is located directly beneath the toilet. Before using the stool, you will need to treat the tank with water that is mixed with an odor controlling chemical. These chemicals are readily available at any RV supply store. Be careful not to spill the chemical on your hands, clothing or the carpet because it may cause a permanent stain. Pull the toilet levers forward to allow the chemical to mix with the toilet water. Continue pulling

the toilet levers until at least one inch of solution is directly under the toilet. Release the levers and the waste tank is ready for use.

### Gray Water Holding Tank

The gray water holding tank is located in the underbelly of the unit. It is primarily used for the drainage from the kitchen and bath sinks and the shower.

### Waste Water Disposal

Both of the holding tanks terminate in a valve arrangement that permits draining each tank separately or together. It is recommended to drain the black water tank before the gray water tank. This will allow the water from the gray tank to wash the black water residue from the drain lines and hose. The valves that open to release the water are called gate valves. The blade that closes the opening in the sewer drain pipes is connected to the T-handle to release the contents of the tank(s) when pulled. The sewer line must be securely capped during self-containment use to prevent leakage of waste material onto the ground or pavement. Do not pull the holding tank gate valve open when the protective cap is installed on the pipe. Always drain the tank into an acceptable sewer inlet or dump station.

#### **CAUTION**

Use only approved RV odor controlling chemicals in the holding tanks. Products containing ammonia and petroleum will damage the ABS plastic holding tanks and seals.

Whenever possible, drain the holding tanks prior to traveling. The carrying capacity of your unit will be reduced if water is left in the black or gray tanks.

The holding tanks should only be drained when they are at least 3/4 full. Doing this provides sufficient water to allow the complete flushing of waste materials in the drain lines and hose. If the tanks are not 3/4 full, add enough water to allow for sufficient flushing. To empty the waste water tanks, connect the adapter to the drain hose. Use the adapter supplied with your unit. If the adapter is lost or broken, one can be purchased from most RV supply stores.

Once you have placed the adapter on the drain hose, it can remain there for the life of the hose. Unscrew the cap off the drain. Connect the hose with the adapter in place to the drain fitting. Open the gate valve all the way by pulling

on the T-handle. The tank will start to drain as soon as the T handle is pulled. After you have drained the black water tank, immediately drain the gray water tank. Doing this helps to flush the black water from the sewage hose.

When both of the tanks are empty, flush them with a fresh water rinse before you close the valves. The gray tanks are easily flushed by pouring a couple of gallons of water into a sink drain. Prime the system with an odor control chemical following the directions above for preparing the system for use. The drain outlet is engineered for quick release of the drain hose adapter. Always close the gate valves and secure the end cap to prevent leakage while in transit. After draining, add enough water to the black water tank to cover the bottom. When using dump stations for draining the holding tanks, please keep other travelers in mind. Practice good housekeeping. Leave the dump stations in good order. Above all, do not pollute.

### Camping with Sewer Hook-Up

When camping at parks with sewer hook-up, it is important to keep the black water holding tank gate valve closed at all times, except when dumping. The gray tank can be kept open while hooked to a sewer connection but again, the black water tank must be kept closed. This is done so that an ample supply of liquid remains in the tank to provide a smooth flow through the gate and drain valve when dumping. Sufficient liquid in the tank causes a swirling action that should take any accumulated solid wastes with it. Accumulation of solid wastes in the black water tank can be avoided by keeping the gate valve closed when connected to the sewer hook-up. If the valve is left open, solid wastes may accumulate in the tank. This may eventually result in costly repairs.

Plumbing &  
Bath Features

<b>CAUTION</b>
The gray tank valve must be in the open position when operating the optional washing machine.

<b>WARNING</b>
Holding tanks are an enclosed sewer system and must be drained into an approved dump station. Both black and gray water holding tanks must be drained and rinsed thoroughly on a regular basis in order to prevent the accumulation of harmful or toxic materials.

## No Fuss Flush

This unit may be equipped with an flushing system for the holding tanks. When draining your sewer tank, attach a water hose to the Sewer Spray hookup. After the tank is drained, leave the gate valve open and open the water valve to allow water to spray inside the sewage tank. This will clean the inside of the tank of any debris that may be left inside the tank. After this is done, disconnect the water hose and close the gate valve. When unsure if any solids are still left inside the tank, fill the sewage tank with approximately ten gallons of water through the stool. Then, as you travel, the agitation of the water should help liquefy any solids left in the tank. You can dump the sewage tank again at your next destination.

### **CAUTION**

Do not use the same hose for the No Fuss Flush that is used for filling the fresh water tank.

Chapter **8**

**SLIDE OUT FEATURES**

**SLIDE OUT FEATURES .....3**  
    General Instructions ..... 4  
    Operating the Slide Out Room (w/mnl locking arms)4  
    Operating the Slide Out Room (w/pwr Lock Arms) .. 5

**MANUAL EXTENSION AND RETRACTION ...6**  
    Shaft end-mounted motors ..... 6  
    Shaft center-mounted motors..... 7  
    Operating Precautions ..... 7





## SLIDE OUT FEATURES

### WARNING

**Read the following slide out room instructions before activating the switch.**

Do not allow children to operate the slide-out.

Do not allow any person to place their arms, legs, body or head between any pinch point of the lock arms, slide-out fascia, interior walls, exterior walls, objects, or floor as serious injury or death could result.

Any adjustments, or repairs, must be made only by "NEWMAR" qualified personnel.

Always check the interior and exterior of the coach for objects, or persons, that are in the path of the slide-out when extending or retracting the room.

Always check the roof to be sure any objects, or debris, are removed before retracting the room.

### CAUTION

It is recommended that the leveling jacks be extended and the unit level before operating the slide out. Note: This slide out can be operated without utilizing the leveling system, but is recommended to have the unit as level as possible.

Your unit is equipped with at least one power slide out room. It is important that you read and understand **ALL** directions, both in this Owners Guide, and on **ALL** the labels affixed inside your unit **PRIOR** to operating your slide out room(s).

Depending on the type of locking mechanism (manual or power) used on your slide out rooms, your unit will contain labels with operating and safety information. Regardless of lock type, there are a number of precautions that **MUST** be observed every time the rooms will either be extended or retracted. For your personal safety, and to prevent potential damage to the slide out mechanism and room, it is paramount that these directions be followed completely. Slide out operation has changed for all 2006 RV's, and it is important that you understand the operation procedure completely and observe all safety precautions to insure safe, proper operation.

All Slide Out labels contain the following warning:

**WARNING**

**Do not allow children to operate the slide-out.**

**Do not allow any person to place their arms, legs, body or head between any pinch point of the lock arms, slide-out fascia, interior walls, exterior walls, objects, or floor as serious injury or death could result.**

**Any adjustments, or repairs, must be made only by “NEWMAR” qualified personnel.**

**Always check the interior and exterior of the coach for objects, or persons, that are in the path of the slide-out when extending or retracting the room.**

**Always check the roof to be sure any objects, or debris, are removed before retracting the room.**

### General Instructions

**IMPORTANT**

The slide out room should be inspected for alignment every six (6) months. If alignment is necessary, have the room adjusted.

### Operating the Slide Out Room (w/manual locking arms)

1. The windows on the end of the slide out room must be closed before moving the room in either direction.
2. Before extending or retracting the room, look for and remove any obstructions.
3. Move any seats or furniture that may interfere with the rooms travel before moving the slide out room in either direction.
4. Disengage the lock arms by pulling down on the center of the arm using the lock arm release tool, as required.
5. Activate the slide out switch in the desired direction to either extend or retract the room. **Please note that you must hold the slide out switch for the duration of movement of the room.** If the switch is released during room extension or retraction, the room will stop moving. When the room has reached full extension or retraction, the slide out will automatically stop.
6. If retracting the room, be sure to engage the lock arms for the slide out room as soon as it has fully retracted.

### IMPORTANT

The slide out room can be stopped at any time by releasing the slide out switch. If the slide out room stops before reaching the full “OUT” or “IN” position, the slide out controller may need adjustment. To adjust the slide out controller, turn the adjustment screw clockwise to increase the power and counter-clockwise to decrease the power. Move the adjustment screw in small increments. Try moving the slide out room again. Use caution. There is a potential for component or structural damage if the screw is adjusted too high. This screw does not adjust the slide out room speed. It sets the amount of power required to move the room against the mechanical stops.

### IMPORTANT

On units equipped with **manual lock arms**, it is important to release the switch as soon it has pulled tight and stopped moving. Current will be applied to the slide out motor as long as you hold the switch. Automatic resetting circuit protection is incorporated to minimize the chance of failures from not releasing the button at the end of room travel, but timely releasing of the button before the circuit protection engages is highly recommended.

## Operating the Slide Out Room (w/optional Power Lock Arms)

Your unit may be equipped with the option of Power Locking Arms for the slide out rooms. Designed specifically for this application, these mechanisms automatically “lock” the slide out rooms to the sidewalls of the RV when the room is fully retracted, securing the room in place and providing a positive seal. The operation of the locking mechanism is totally automatic, and begins when you press the button to extend or retract the slide out room.

To extend the room, press and hold the slide out button. The voice modulator will activate and say, “Your lock arms are unlocking. Please be certain all seats, chairs, and other obstacles clear of the slide out area”. The power lock arms will retract into their housings, and the room will begin to extend approximately 10 seconds after the voice begins. It will continue to run until it reaches the end of its travel, or until you release the slide out switch.

To retract the room, press the slide out button as described above, holding it for the duration of room travel. The room will retract, and at the end of its travel the slide out motor will stop, and the Power Locking Arms will deploy,

securing the room to the sidewall of the unit. Please note that you must hold the slide out button down during this entire cycle.

The power locks require a minimum of 9 volts DC to operate. In the event of a loss of power, or if the voltage dips below the minimum requirements, the locks will not extend or retract automatically. For proper operation of the room and locks battery voltage must be maintained above the minimum requirements. Also please note that there is a safety “lock out” system incorporated in the slide out electronics that prevents the room from operating when the ignition key is “on”. The automatic locking arms require no maintenance, and should be serviced as necessary only by a qualified technician.

#### **IMPORTANT**

**On X-Aire units, be sure to check the ladder to loft to make sure it is out of the path of slide out travel before operating the slide out room.** Failure to do so can damage the ladder and slide out, as well as cause injury to anyone its path of motion.

## **MANUAL EXTENSION AND RETRACTION**

### **Shaft end-mounted motors**

If the motor is mounted on the ends of the slide out shaft, use the following directions:

- 1.** Access must be gained to the TRANS-TORQUE bushing coupling at the end of the slide out gear motor.
- 2.** Using a 1/2" drive – 11/2" open end wrench and a 1/2" drive ratchet wrench, loosen the 1 1/2" nut. This will require approximately 1 1/2 turns. The nut is a standard right hand thread. After the initial release, the nut will turn for a partial turn, and then will release again as you turn the wrench. This second release is required to loosen the TRANS-TORQUE bushing from the shaft.

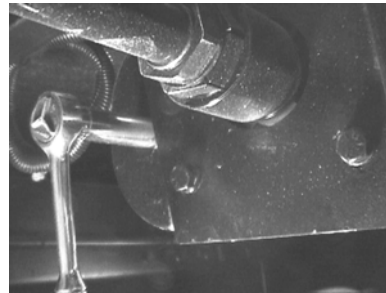

## Shaft center-mounted motors

If the unit is equipped with the K-900 slide out motor which is mounted near the center of the slide out room, use the following directions:

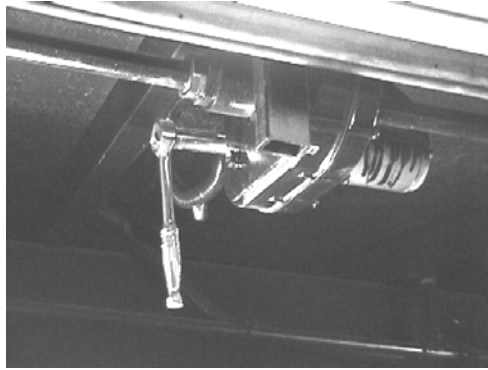

1. Access must be gained to the slide out motor located in the center of the slide out room.
2. The manual extension or retraction requires only a 5/8" socket and ratchet wrench. By placing the socket on the 5/8" hex nut located on the gear box of the K-900 motor, the slide out can be moved in either direction by turning the hex nut.
3. If the slide out does not move by using the hex nut, the room can also be extended or retracted by using the procedure described for the shaft end-mounted motors. If the room is moved using this method, the correct torque on the 1 1/2" trans-torque nut is 125 foot pounds maximum.

### IMPORTANT

The TRANS-TORQUE bushing must be re-tightened to re-couple the slide out gear motor before moving the coach. This will hold the slide out room in place. The correct torque on the 1 1/2" TRANS-TORQUE bushing is 110 foot pounds maximum. The correct torque on the 1 1/2" TRANS-TORQUE bushing of the K-900 motor (center shaft motor) is 125 foot pounds maximum. Slide outs with either the center or end mounted motors can be moved by pushing the room the full length of its travel in either direction. This method will require the assistance of at least two people.

## Operating Precautions

### CAUTION

It is recommended that the leveling jacks be extended and the unit level before operating the slide out. Note: This slide out can be operated without utilizing the leveling system, but is recommended to have the unit as level as possible.

## **WARNING**

Before extending the slide out, make certain that there is a minimum of five (5) feet of clear space on the slide out side of the unit. Prior to extending the room, be sure to unlock the slide out locking arms. Make sure there are no obstructions either inside or outside the unit that may interfere with the slide out extension. Tree branches, bushes or telephone poles can cause extensive damage to the exterior of the unit.

# ROUTINE MAINTENANCE

**EXTERIOR CARE ..... 3**

- Washing ..... 3
- Waxing ..... 3
- Seals..... 4
- Striping & Decals ..... 4
- Rubber Roof Care & Maintenance ..... 5
- Battery Inspection & Care ..... 6

**INTERIOR CARE ..... 7**

- Carpet..... 7
- Fabrics ..... 7
- Wall and Ceiling ..... 8
- Woodwork..... 9
- Counter Tops..... 9
- Accessories ..... 9
- Detectors ..... 9
- Condensation ..... 10

**ROUTINE MAINTENANCE ..... 10**

- Every Trip ..... 11
- Every Three (3) Months ..... 11
- Every Six (6) Months..... 11
- Annually ..... 12
- Winterizing..... 12
- Cold Weather Use ..... 13







## EXTERIOR CARE

### IMPORTANT

Damage caused by improper or unapplied maintenance is not covered by your Newmar Limited Warranty.

### Washing

The exterior of your new camping vehicle is made of pre-finished aluminum and/or fiberglass. Frequent washings and thorough cleanings are required to prevent damage to the vehicle finish after exposure due to damaging salts, calcium chloride, road tar, tree sap, insects and other foreign material. Damage caused by exposure to these items is not covered by your Newmar Limited Warranty. Never wash the vehicle in direct sunlight, while the vehicle is hot or with hot water. Build up of mud and dirt under the body can cause damaging rust on steel parts. Corrosive materials, such as those used for ice and snow removal and dust control, also accumulate on the underside of the vehicle. These materials should be removed by spraying the underbelly regularly with water, especially areas where mud and other foreign materials collect. The chance of corrosion can be minimized by frequent washings of the vehicle. When washing the vehicle, make certain that the undercarriage and the wheel wells are cleaned, as well as the exterior of the coach. Do not use strong soaps or detergents for washing the vehicle. Always use a mild soap in warm water, a commercially prepared product for automotive finishes or your local car wash. Be careful when using a pressure-type washer to avoid loosening any exterior decals or sealants, etc.

After washing, carefully inspect the caulking around window frames and vents and any other joints that may have separated. Recaulking, if necessary, is relatively simple, and is considered routine maintenance which is the responsibility of the owner.

### Waxing

The exterior finish will require a routine waxing. When water will not bead and roll off a freshly washed vehicle, a new coat of wax is needed. Wax not only improves the appearance of the vehicle, but it also protects the finish against oxidation and corrosive materials. The recommended type of wax is one that is compatible with painted or gel-coated fiberglass finishes, and

Routine  
Maintenance

contains a UV (ultra-violet) inhibitor. Buffing with a polishing compound will improve a dull or discolored finish.

**IMPORTANT**

Never use a strong solvent, such as lacquer thinner or harsh abrasives, on any of the exterior painted surfaces.

**Seals**

The seals around doors, windows, vents, slide out trim and external seams should be checked at least twice a year. In addition, the roof seams should be inspected twice a year for cracking or peeling. If deterioration is noted during a routine maintenance inspection, reseal the seams or seals with an approved sealant to prevent leaks. Your dealer can perform the resealing inspections and work for you. It is recommended that a Newmar Authorized Service Center perform these inspections, and reseal when necessary.

**Proper Sealants for Application**

<b>Plas-T-Cote .....</b>	<b>Metal or fiberglass roof</b>
<b>Surebond #SB-140 .....</b>	<b>Rubber laminated to metal roof and all skylights.</b>
<b>Carlisle #502-LSW .....</b>	<b>Rubber roof over wood Base</b>
<b>Self Leveling Sealant</b>	
<b>Silicone Sealant .....</b>	<b>To cover butyl and other sealants; not to be used as the main sealant</b>
<b>Parbond .....</b>	<b>To seal across tops of windows, etc. on exterior where silicone is not used</b>

**Striping & Decals**

The striping and decals on your vehicle require little maintenance. Treat these as you would any painted surface on your vehicle. Wash them with mild soap and warm water, or any retail car soap. Never wash the vehicle in direct sunlight, while the vehicle is hot or with hot water. Rinse thoroughly to prevent soap residue accumulation. Use caution with high pressure wash nozzles. Keep them at least 18 inches from the edge of the decals. High

pressure water may cause the decals to loosen and peel. Test small sections of decals when using any type of cleaning solution.

#### **IMPORTANT**

When using a polishing compound that does not contain a wax preservative, reapplying a coat of hard wax after polishing is recommended.

### **Rubber Roof Care & Maintenance**

Proper care and maintenance of your recreational vehicle, including your rubber roof, is important for trouble-free performance. Normal maintenance is simple and easy, and does not require special materials. Keep the roof clean. Clean the roof at least four (4) times annually. For normal cleaning:

1. Use RC100 Dicor Synthetic Roof & General Purpose cleaner or a mild laundry detergent.

#### **CAUTION**

Do not use general purpose cleaners or conditioners containing petroleum solvents, harsh abrasives or citric-based cleaners. You may cause irreparable damage to your roof.

#### **WARNING**

Use caution when working on top of your vehicle. The wet roof membrane may be extremely slippery.

2. Rinse the complete roof with clean water to remove any loose dirt or debris.
3. Using a medium bristle brush, along with your selected cleaner mixed with water, scrub the entire roof. Rinse thoroughly with clean water to avoid residue build up on the roof or sidewalls of the vehicle.
4. For more difficult stains, you may use cleaning materials mentioned above in a more concentrated mixture. For stubborn stains, use of a cloth dampened with household bleach. Household bleach can be used (fully concentrated) and allowed to soak in stubborn stain areas, then scrubbed with a medium bristle brush or rag. Rinse thoroughly. **DO NOT** pour the

bleach on the roof and allow it to run down the sides of the vehicle.  
Concentrated bleach may damage the graphics.

## Battery Inspection & Care

### **WARNING**

Remove rings, metal watch bands and other metal jewelry before working around batteries. Use caution when using metal tools. If a tool contacts a battery terminal or metal connected to it, a short circuit could occur which could cause personal injury, explosion or fire.

Remember, when a battery is not used for an extended period of time, it may lose its charge. Periodic charging of the battery during storage of the unit will increase the life of the battery. Check the external condition of the battery periodically. Look for cracks in the cover and case. Check the vent plugs and replace them if they are cracked or broken. Keep the battery clean.

Accumulations of acid film and dirt may permit current flow between the terminals, which could drain the battery. To clean, wash the battery with a diluted solution of baking soda and water to neutralize any acid present. Rinse thoroughly with clean water. Foaming around the terminals or on top of the battery is a sign that acid is being neutralized. Avoid getting the baking soda solution in the battery. Secure all vent caps. Dry the battery cables and terminals. Do not use grease on the bare metal inside the cable terminals to prevent corrosion. Grease can act as an insulator. Electricity will not flow through it. A plastic ignition spray will protect the terminals after they have been cleaned.

When storing the unit for a short period of time, the battery should be disconnected from the coach to prevent draining. As an option, your unit may be equipped with a battery disconnect switch. Simply push the switch to the STORE position when storing your unit. To use the unit again, simply push the switch to the USE position. If the unit is not equipped with a disconnect switch, disconnect the cables directly from the battery.

When not using your unit for an extended period of time, the battery should be removed and stored in a warm place. Mark the cables, positive and negative, for easy identification. Batteries are not to be stored on concrete floors. The battery may require periodic charging during storage. If the unit is to be stored for a long period of time, it is recommended that all the batteries inside the unit

be removed from clocks, radios, smoke alarms, etc. This will prevent unnecessary drain and corrosion of the batteries. The coach battery is a deep cycle RV/marine battery. This type of battery consumes water and must be filled periodically. Please be sure to check the battery water level on a regular basis. Consult the owner's manual supplied by the battery manufacturer.

#### **WARNING**

Do not allow the battery fluid to contact your skin, eyes, fabric, or painted surfaces. The fluid could cause serious personal injury or property damage. Wear eye protection when working with any battery.

#### **CAUTION**

Disconnect the 120 volt electrical power cord and the negative terminal from the coach batteries before working on the electrical system.

## **INTERIOR CARE**

### **Carpet**

A weekly routine of vacuuming the carpet and fabrics throughout the vehicle is recommended. Doing this will prevent an accumulation of dirt that can detract from the materials appearance and shorten its life. Remember to empty or replace vacuum bags before they become half full. In carpet areas that receive the most sunlight, close the curtains frequently to prevent fading. And act quickly when anything is spilled or dropped on the carpet. Included in the Owner's Information Package is the carpet manufacturer's Carpet Care Guide. The Carpet Care Guide lists detailed information on cleaning soiled areas and removing stains from the carpet installed in the unit.

### **Fabrics**

The fabrics used in this unit for the bedspread, draperies, headboard and valances may contain fire-retardant additives that can be damaged by use of improper cleaning products. Cleaning instructions for these fabrics are DRY CLEAN ONLY. Water-based products are not recommended for cleaning the fabrics in your new unit. Most water-based household cleaning products are not formulated for use on these fabrics and may cause excessive shrinkage or fading. Always test any cleaning product on a hidden area of fabric before

using on visible areas. For best results, the fabrics in this unit should be cleaned by a professional carpet and upholstery cleaner. Spills, spots or stains should be treated as soon as possible to avoid permanent damage. If a spill occurs, blot the fluid with a dry towel. Do not rub the spill. Rubbing may cause the liquid to set in the fabric. When attempting to clean a spot or stain, always start from the outside and work inward to avoid spreading it further. Some stains or soils are extremely difficult or impossible to be removed completely. These should receive immediate, professional attention. Spills, spots, stains or soils are the responsibility of the owner, and are not covered by the Newmar Limited Warranty.

#### **WARNING**

When cleaning the upholstery and fabric in the unit, do not use lacquer thinner, nail polish remover, laundry soaps or bleach. Never use carbon tetrachloride or gasoline for cleaning purposes. These items may cause damage to the materials being cleaned, and most are highly flammable.

#### **IMPORTANT**

The fading of upholstery, carpet and other interior fabrics is generally caused by excessive sunlight. The drapes, blinds or shades should be kept closed when the vehicle is parked for an extended period of time to minimize the fading. Normal deterioration of appearance items due to wear and/or exposure is not covered by the Newmar Limited Warranty.

### **Wall and Ceiling**

The wall and ceiling coverings should be cleaned periodically to maintain a new appearance. Use a non-abrasive cleaner with a soft cloth. Do not use solvents of any kind. Solvents may damage the surface.

#### **WARNING**

Urea-formaldehyde is used in the productions of particle board, hardwood plywood, and most paneling. Urea-formaldehyde resin may release formaldehyde vapors into the air, which may cause headaches, and in some people, eye, nose and throat irritation. Formaldehyde may intensify some allergies or upper respiratory problems like asthma. Proper ventilation should reduce the risk of such problems.

## Woodwork

The wood cabinetry should be cared for with furniture polish to sustain the natural beauty and luster of the wood. This will also keep your cabinetry looking new, and prevent the wood from drying. The simulated plank flooring should be protected from dents, scratches and nicks by installing protective pads on the bottom of chairs and tables. Use of area rugs and floor mats by the entrance door is recommended to trap dirt. To clean the flooring, begin by vacuuming the floor to remove loose dust and dirt. Then, damp mop the floor with one ounce of Wilsonart Flooring Cleaner diluted in one gallon of clean, warm water (or use a non-abrasive, soap-free cleaner). The mop should be damp, not dripping. Do not use soap-based cleaners, scouring powders, steel wool, abrasive cleaners, wax or polish on the floor. To remove stubborn spots like shoe polish, oil, tar, markers, scuffs, etc., use a household solvent, acetone or nail polish remover, then wipe with a damp cloth. To remove chocolate, grease, juice or wine, use warm water and a non-abrasive cleaner. To remove candle wax or chewing gum, carefully scrape off when the material has hardened. For further tips, please see the manufacturer's information sheet in your Owner's Information Packet.

## Counter Tops

To properly care for the Corian counter top in your new unit, always use a heat pad or trivet to protect the surface from hot objects that may mar or damage the surface. Wipe the counter top with a damp cloth to remove water spots. For most dirt and stains, wipe with soapy water or ammonia-based cleaners. For watermarks wipe with a damp cloth, then towel dry. Occasionally, disinfect by wiping the surface with diluted household bleach (one part water/one part bleach).

## Accessories

The brass light fixtures, bath accessories and faucets can be cleaned by wiping with a soft, damp cloth. Washing with warm water will remove dry water spots. Do not use cleaners that contain harsh or abrasive chemicals. Alcohol or similar solvents should never be used.

## Detectors

The Propane and CO detectors (if equipped) are self-contained and DO NOT require any maintenance other than normal cleaning and dusting. When





cleaning the exterior of the case use a damp cloth or paper towel. Do not spray cleaners or wax directly into the case as it may cause false alarms.

## Condensation

### IMPORTANT

Since surface condensation within the coach cannot be controlled by the manufacturer, damage caused by condensation is not covered by your Newmar Limited Warranty.

Damage may occur to your unit if excessive condensation exists.

Accumulation of condensation on surfaces within your unit occurs when warm, moist air contacts a cool surface. It is most evident on the inside of windows. This problem can be controlled by:

1. Slightly opening a window or roof vent to allow the moisture to escape from the unit.
2. A small dehumidifier is also very effective in removing moisture from the air.
  - Condensation levels are highest during times when a person is cooking or taking a shower in the unit, but these are not the only times condensation is present.
  - Condensation can migrate through ceiling panels and saturate the fiberglass insulation in your ceiling cavity. This condition often causes the occupants to believe the recreational vehicle has a roof leak. Walls and ceiling panels may also become wet when the moisture accumulates on these surfaces.
  - Newmar Corporation does not recommend the use of any catalytic heaters.

## ROUTINE MAINTENANCE

All routine maintenance is the responsibility of the owner and is not covered by the Newmar Limited Warranty. Use the maintenance record found in Chapter 15 to record all performed maintenance as required. Please note that damage caused by improper or unapplied maintenance is not covered by the Newmar Limited Warranty. Items supplied by other manufacturers may require specific individual maintenance not listed herein. Please refer to the manufacturers suggested maintenance guidelines in the Owners Information Packet.

### Every Trip

- Check brake operation prior to towing.
- Check the tire pressure of all tires.
- Torque all wheel lug nuts.

### Every Three (3) Months

- Clean exhaust fan filter and blades.
- Test smoke alarm and Propane gas detector.
- Check operation of windows, latches and hinges.
- Clean the roof-ducted air conditioner filter(s).
- Clean and inspect all door and window seals; reseal when necessary.
- Inspect and reseal around the tub and shower area, when necessary.
- Lubricate the exterior door hinges and latches with a graphite (silicone) lubricant.
- Check, clean and tighten battery cables, and inspect battery for proper fluid level.

### Every Six (6) Months

- Inspect the slide out for proper seal. If realignment is necessary, please contact an Authorized Newmar Service Center.
- Inspect the exterior rubber slide out seals and apply a UV inhibitor, such as 303 Protectant.
- Rotate tires as recommended by the tire manufacturer.
- Check all gas appliances for proper operation.
- Have the Propane system inspected by a qualified technician.
- Lubricate the moveable parts on the entrance step.
- Check the wheels and lug nuts for cracks, and check the torque of the lug nuts.

#### **IMPORTANT**

Cosmetic adjustments and alignments must be performed within the first three (3) months from date of original purchase for warranty consideration.

Thereafter, these items are considered routine maintenance.

## Annually

- Inspection of roof seams and joints should be performed by an Authorized Newmar Service Center. If resealing is necessary, it is the owner's responsibility and is not covered by the Newmar Limited Warranty.
- Sanitize the fresh water system.
- Have the axle bearings re-packed, wheel seals replaced and brakes inspected.
- Wax and buff all gel-coat surfaces on the vehicle as described previously in this chapter.

## Winterizing

To store your unit for the winter months, it is necessary to winterize the water system to help prevent freezing. To do this, follow these instructions:

1. The water heater must remain off during this process. Shut off the water pump and make sure the water supply valves are closed. Disconnect the city water fill.
2. To drain the fresh water tank, open the drain valves.
3. Open the low point drain valves. There is one drain valve for each water line, one cold and one hot. This is done to drain all of the water out of the system.
4. After the water heater has cooled off, remove the drain plug to drain the water from the water heater. In the exterior compartment beside the water heater there are two water heater shut off valves and a by-pass valve. The shut off valves must be closed and the by-pass valve must be open, prior to winterizing to prevent the antifreeze solution from entering the water heater.
5. Close the low point drains to prevent the antifreeze from draining through the lines onto the ground.
6. Close the water supply valve that flows from the pump to the tank.
7. Use only non-toxic antifreeze that has been approved for use in drinking/potable water systems. Place the in-take hose into the antifreeze supply. Open the antifreeze valve to allow the solution to flow freely. Once the water pump is turned on, proceed to the kitchen faucet, bath faucet, inside and outside shower, turning on the hot and cold, and flushing the stool until the antifreeze solution flows freely. If the unit is equipped with a washer, be certain to purge the air from it also. This forces the antifreeze through all of the water lines and faucets. It also allows the antifreeze solution to enter the drain lines and prevent the

P-traps from freezing. Check the antifreeze solution from time to time to make sure there is an adequate supply.

- 8.** Close the antifreeze valve when the winterizing process is complete. Store the in-take hose, and turn the water pump off.
- 9.** Open the water supply valve that flows from the pump to the tank to help prevent freezing on that water line.
- 10.** To de-winterize your unit, open both of the low point drains to allow the antifreeze solution to drain from the water system. Next, close the low point drains and connect your unit to city water. Put water in the fresh water tank and pump at least one gallon through the water pump in order to remove the antifreeze from the water pump. Keep the water heater supply valve closed and the water heater bypass valves open. The supply valve for the fresh water tank from the pump must remain closed. As in winterizing, open the kitchen faucet, bath faucet, inside and outside shower, turning on both the hot and the cold, and flushing the stool until the antifreeze solution is flushed out of the system and the water flows clear. Once the system has been flushed, open the water heater supply valve and close the water heater bypass valve. Open the fresh water tank supply valve from the pump and the ice maker valve. Reinstall the water filter. Be sure to close the fresh water tank drain valves to allow the tank to fill.

### **Cold Weather Use**

Although great care has been taken to build a well-insulated unit, recreational vehicles are not intended for extended use in subfreezing weather without special precautions. When the temperature drops below freezing, the furnace must be turned on to keep the unit warm. Continued use in cold weather will require the unit to be winterized.