

# DUTCH STAR

## 2015



WHEN YOU KNOW THE DIFFERENCE

Welcome to the exciting world of recreational vehicle traveling and the growing Newmar family!

Congratulations on your purchase of a Newmar product. We sincerely thank you for choosing Newmar as your recreational vehicle. We hope that you will enjoy many miles of traveling. Your new vehicle was built with care using today's technology and old world craftsmanship. We, at Newmar, strive to build vehicles that are safe, dependable, and comfortable to provide you with years of carefree, pleasant traveling. With your new RV purchase, Newmar provides a 12-month limited warranty. Please read the Newmar Limited Warranty and all other component warranties that apply to the equipment installed on your unit.

Carefully read both the instructions in this Owner's Guide and the booklets supplied by the chassis and component manufacturers for important operation, safety, and maintenance requirements/information. Your dealer should be consulted should you have any questions. If your dealer is unable to answer the questions to your satisfaction he will refer you to our staff for assistance. Our customers are extremely important to us and we will make every effort necessary to ensure your satisfaction.

The limited warranties issued by the chassis and component manufacturers require periodic service and maintenance. The owner's failure to provide this service and/or maintenance may result in the loss of warranty coverage. Be sure to file the appropriate registration card with the component manufacturer as described with the individual instruction booklets to activate the warranties on the components within your Newmar RV. This Owner's Guide should be kept in your vehicle for quick reference. Take time to get acquainted with your unit and how it operates.

Again, thank you and welcome to the Newmar family.

Newmar Corporation



This guide has been provided by Newmar Corporation solely for the purpose of providing instructions about the operation and maintenance of this vehicle and its components. Nothing in this manual creates any warranty, either expressed or implied. The only warranty offered by Newmar Corporation is set forth in the written limited warranty that applies to this vehicle.

Instructions are included in this manual for operating some of the components that are standard on this vehicle. Instructions are also given for components that are options and may not appear on all vehicles. For more detailed information on components, refer to the individual manufacturer's operating instructions contained in the Owner's Information Package.

The limited warranties issued by the chassis and component manufacturers require periodic service and maintenance. The owner's failure to provide this service and/or maintenance may result in the loss of warranty coverage. The owner should review the Newmar Corporation Limited Warranty and other manufacturer's limited warranties on all components applicable to this vehicle. To activate the warranties on the components within your Newmar recreational vehicle, be sure to file the appropriate registration card with the component manufacturer as described with the individual instruction booklet.

Throughout this guide, reference is made to the following terms: Warning, Caution, and Important. These terms indicate important information that must be understood and followed. The definitions of these terms are:

 **WARNING**

Emphasizes an area in which personal injury or even death could result from failure to follow instructions properly. Mechanical damage may also occur.

 **CAUTION**

Failure to observe a caution can cause damage to the equipment or unit. Personal injury is unlikely.

 **IMPORTANT**

This will provide additional information to make a step easier or clearer.

Chapter **1**

## **SERVICE INFORMATION**

CUSTOMER ASSISTANCE .....	9
COMPONENT PART SUPPLIERS .....	9
Accessories	
Air Conditioning	
Appliances	
Electrical (tires and batteries separately warranted)	
Exterior	
Heating	
TO OUR VALUED CUSTOMERS: .....	12\

Chapter **2**

## **GENERAL & SAFETY INFORMATION**

DELIVERY .....	13
Dealer Responsibilities	
Customer Responsibilities	
Recreational Vehicle Limited Warranty	
Warranty Service Deadline	
Owner's Information Package	
Customer Relations	
Reporting Safety Defects	
Information Sheet	
IMPORTANT RV TIRE INFORMATION .....	16
READ AND UNDERSTAND THE FOLLOWING	
INFORMATION BEFORE TAKING YOUR FIRST TRIP	
IN YOUR RV!	
SAFETY PRECAUTIONS .....	17
Before Starting Out	
Driving	
Propane & Fuel	
Propane Gas System General Information	
Propane Regulator	
Propane Distribution Lines	
Precautions & Recommendations	
Fire Safety	
Fire Extinguisher	

Smoke Detector  
Emergency Exit Window  
Weight Information  
Weighing the Unit  
Campsite Parking  
Car Towing Hitch  
Occupant Restraints

### Chapter 3

## HVAC, APPLIANCES & ACCESSORIES

HEATING & AIR CONDITIONING .....	27
Air Conditioning	
FURNACE .....	32
Heating - Oasis	
Propane Tank	
Propane Tank Filling	
Propane Regulator	
Propane Leak Detector	
MAJOR APPLIANCES .....	35
Refrigerator	
Microwave	
Range Hood	
Range	
Television Antenna	
Television	
Cable & Telephone Jack	
Exterior Entertainment Center (optional)	
Stereo	
Water Heater	
Water Heater Storage	
Pressure Relief Valve	
CB Radio/Antenna (Optional)	
Rear View Monitor System	
Air Horns	
Freezer (if equipped)	
Icemaker (if equipped)	
Washer/Dryer (if equipped))	
Carbon Monoxide Detector	

Chapter **4**  
**CABINETS, FURNITURE & INTERIOR  
FEATURES**

CABINETS .....	43
FURNITURE.....	43
Living Room/Kitchen Area	
Bedroom Area	
INTERIOR FEATURES .....	44
Flooring	
Ceiling	
Window Treatment	

Chapter **5**  
**ELECTRICAL FEATURES**

<b>ELECTRICAL SYSTEMS.....</b>	<b>45</b>
General Information	
Breaker Boxes	
Batteries	
Battery Boost Switch	
Battery Inspection & Care	
Battery Disconnect Panel	
12 Volt Receptacles	
120 Volt Receptacles	
Ground Fault Circuit Interrupt Receptacles	
ICC Flasher	
Inverter/Converter	
Generator	
Automatic Transfer Switch	
Wiring Connector	

Chapter **6**  
**EXTERIOR FEATURES**

EXTERIOR FEATURES.....	51
Exterior Sides	

Security Lights	
Head Lamps	
Roof	
Leveling Jacks	
“Hydraulic” Leveling	
Electric Steps	
Mirrors	
Windows	
Vents	
Doors	
AWNING.....	55
Side Awning	
Extending	
Retracting	
 Chapter <b>7</b>	
<b>PLUMBING &amp; BATH FEATURES</b>	
FRESH WATER SYSTEM.....	57
Monitor Panel	
Monitor Panel Calibration	
Water Pump	
City Water Hook-Up	
Fresh Water Tank Fill	
Sanitizing	
Water Filtration System	
Water Heater By-Pass System	
Fresh Water Lines	
Exterior Shower	
WASTE WATER SYSTEM .....	60
General Information	
Toilet	
P-Traps	
Black Water Holding Tank	
Gray Water Holding Tank	
Waste Water Disposal	
Camping with Sewer Hook-Up	
No Fuss Flush	

Chapter **8**

**SLIDE OUT FEATURES**

SLIDE OUT FEATURES ..... 65  
    General Instructions  
    Operating the Slide Out Room (w/manual locking arms)  
MANUAL EXTENSION AND RETRACTION ..... 66  
    Operating Precautions

Chapter **9**

**ROUTINE MAINTENANCE**

EXTERIOR CARE..... 69  
    Washing your RV  
    Drying your RV  
    Waxing  
    Seals  
    Striping & Decals  
    Wheel Care  
    Rubber Roof Care & Maintenance  
    Battery Inspection & Care  
INTERIOR CARE..... 73  
    Carpet  
    Fabrics  
    Walls & Ceiling  
    Dash  
    Woodwork  
    Counter Tops  
    Accessories  
    Detectors  
    Condensation  
ROUTINE MAINTENANCE ..... 76  
    Monthly  
    Every Three (3) Months  
    Every Six (6) Months  
    Annually  
    Winterizing



Head Lamps  
Cold Weather Use

## Chapter 1

# SERVICE INFORMATION

## CUSTOMER ASSISTANCE

Newmar Corporation .....	1-800-731-8300
Ford Motor Company .....	1-800-444-3311
Freightliner Custom Chassis .....	1-800-FTL-HELP
Spartan Motors.....	1-800-543-4277
Spartan Roadside Companion.....	1-888-890-1741
Workhorse Custom Chassis .....	1-877-946-7731

## COMPONENT PART SUPPLIERS

### Accessories

Back Up Monitor	Alpha Systems .....	574-295-5206
	A. S. A. Inc. ....	574-266-1886
CB Radio (Cobra)	Tri Star Distributing .....	800-456-3340
Computer TripTek	River Park, Inc. ....	800-442-7717
Furniture (Upholstered)	Flexsteel Industries .....	563-556-7730
	Villa International .....	562-404-8111
Navigation	Mito .....	888-433-6486
Roof Vent	FanTastic Vent Corp.....	800-521-0298
	Ventline .....	574-848-4491
Security System	Tri/Mark. ....	800-447-0343
Stereo - Dash	Mito .....	888-433-6486
Stereo (Sony)	River Park, Inc. ....	800-442-7717
TV Antenna	The Winegard Co. ....	800-288-8094
Television (Sony)	River Park, Inc. ....	800-442-7717
Satellite Dish (Winegard)	The Winegard Co. ....	800-288-8094
Satellite Dish (KVH)	River Park, Inc. ....	800-442-7717
DVD	River Park, Inc. ....	800-442-7717

### Air Conditioning

Dash Air	Evans Tempcon .....	800-354-7088
Roof Air	Dometic .....	800-544-4881

### Appliances

Dishwasher,	Midwest Sales .....	574-287-3365
Freezer	Dometic .....	800-544-4881

Microwave (Dometic)	Dometic .....800-544-4881
Microwave (GE)	Midwest Sales .....574-287-3365
Range	Atwood-Greenbrier.....815-877-5700
	Magic Chef .....515-792-7000
Refrigerator	Dometic .....800-544-4881
	Norcold .....800-543-1219
Water Heater - Atwood	Atwood Mobile Prod. ....815-877-5700
Water Heater - Suburban	Suburban Mfg. ....800-659-2138
Water Heater - Oasis	ITR.....800-993-4402
Washer/Dryer, 1-piece	Splendide .....800-736-4127
Washer/Dryer, 2-piece	Whirlpool.....800-442-1111

**Electrical (tires and batteries separately warranted)**

Batteries - 12Volt	Interstate .....800-872-4100
Batteries - 6 Volt	Interstate .....888-772-3600
Inverter/Converter	Magnum.....425-353-8833
Generators	Onan .....800-888-6626

**Exterior**

Awning & Hardware	A & E.....800-544-4881
	Carefree of Colorado .....800-621-2617
	Girard.....800-382-8442
Jacks (CA & DP)	H W H Corporation .....800-321-3494
Jacks (FW)	Atwood Mobile Prod. ....815-877-5700
	Equalizer Systems. ....800-846-9659
Rubber Suspension (FW)	Mor-Ryde, Inc. ....574-293-1581
Steps, Electrical	Lippert/Coach Step .....574-535-2085
Steps, Electrical	Kwikee Products.....800-736-9961
Steps, Manual	Hickory Springs Mfg. ....574-262-2399
Tires	Goodyear .....800-227-1999
	Michelin.....803-234-5000

**Heating**

Furnaces	Atwood Mobile Prod. ....815-877-5700
	Suburban Mfg. ....800-659-2138
Furnace, Hydronic	ITR.....800-993-4402

Please note that your Newmar Limited Warranty is activated only after Newmar has received a signed Warranty Registration Form from your selling dealer. If it has been more than 60 days since the purchase of your new coach and you have not received your Newmar Owner's Warranty Card, please contact your selling dealer or the Newmar Warranty Department at 800-731-8300.

## **TO OUR VALUED CUSTOMERS:**

If, for any reason, you have a problem obtaining satisfactory and timely warranty service that may substantially impair the use, value or safety of your Newmar product, please call us on our toll free line at 800-731-8300 so that we may attempt to resolve your concerns.

All of the information contained in this brochure is believed to be accurate at the time of publication. However, it may be necessary to make revisions and Newmar reserves the right to make any such changes without notice or obligation. Please refer to the component information literature provided in the Owner's Information Package for specific warranty details for the components applicable to your recreational vehicle.



NEWMAR CORPORATION  
355 N DELAWARE ST  
PO BOX 30  
NAPPANEE, IN 46550-0030  
*[www.newmarcorp.com](http://www.newmarcorp.com)*

## GENERAL & SAFETY INFORMATION

### DELIVERY

Throughout the manufacturing process your vehicle has been inspected by our qualified technicians. However, our final inspection at the factory is not to be the last one. The pre-delivery inspection and systems check your dealer performs are the final inspections done to the unit prior to you receiving your new coach. Your dealer is also available to assist you in understanding the limited warranties and completing any necessary forms to activate the warranties for the various appliances and accessories installed in your unit.

#### Dealer Responsibilities

1. A pre-delivery inspection and systems check. Thoroughly inspecting the vehicle and the operation of the factory installed components.
2. A customer walk-through. This is done to familiarize the customer with the vehicle, its systems and components, and their operation.
3. Delivery of the Owner's Information Package. This package contains the warranty cards and registrations for the vehicle and factory installed components that carry a separate warranty. The detailed operating and maintenance instructions on these components are also included in this package.
4. Assisting the customer in completing the component registration forms, at the customer's request. To avoid loss of warranty coverage, the dealer should review the limited warranty provisions with the customer stressing the importance of filing warranty cards and registrations to the component's manufacturers within the prescribed time limit.
5. Providing the customer with information regarding warranty and non-warranty work on the vehicle and its separately warranted components whether the customer is in or out of the area.

#### Customer Responsibilities

The customer is responsible for regular and proper maintenance of the vehicle. Properly maintaining your vehicle will prevent conditions arising from neglect that are not covered by your Newmar Limited Warranty. The maintenance guidelines in this manual and any other applicable manual should be followed. It is your responsibility and obligation to return the vehicle to an authorized dealer for repairs and service.

To assist you in avoiding problems with your vehicle, we recommend you do the following:

- A. Read the warranty.** Go over it thoroughly with your dealer.
- B. Inspect the vehicle.** Do not accept delivery until you have gone through the unit with the dealer. Newmar has provided a check list to be used during retail delivery. Check each item on the list and make sure the dealer does the same. Do not sign this checklist until you have done this.

NOTE: The sales literature versus actual specifics to the vehicle's measurements, weights, or quantities may vary.

- C. Ask questions** about anything that you do not understand concerning your recreational vehicle.
- D. When taking delivery**, set an appointment for adjustments. This appointment should be approximately two (2) weeks after you accept delivery.
- E. Responsible Use.** Your vehicle is designed to be used for recreational or temporary living purposes. It is not designed to be used as a full-time residence or for commercial use. Commercial use means using as a business asset such as a mobile office or using the vehicle for lease/rental purposes.

### Recreational Vehicle Limited Warranty

The Newmar Corporation Limited Warranty was provided to you by your selling dealer prior to purchase. Please refer to this document when inquiring about the Newmar Warranty. To receive an additional copy, refer to the contact information under "Customer Relations".

### Warranty Service Deadline

Warranty service required needs to be completed during the term of the warranty. Service work scheduled or performed after the expiration of the Newmar warranty **WILL NOT** be covered.

### Owner's Information Package

Included in this package are valuable documents about your vehicle and its components and systems. The Newmar Owner's Guide does not cover every possible detail of the equipment, standard and/or optional, installed on or in your vehicle. Consulting the booklets and instruction manuals in this package will help you safely operate, maintain, and troubleshoot these items.

Read all of the information and understand the safety and operating instructions included in the Owner's Information Package. To assure full warranty coverage, it is essential that all maintenance instructions are followed.

### Customer Relations

If you wish to schedule maintenance work, schedule service work, or order parts you should notify your local authorized Newmar Service Center to set up an appointment. If you are unsure of the location of the closest authorized Service Center, please contact us as follows:

Newmar Corporation  
Warranty Department  
72185 C.R. 3  
P.O. Box 30  
Nappanee, IN 46550-0030

Call us at: 1-800-731-8300

Visit us at [www.newmarcorp.com](http://www.newmarcorp.com)

## Reporting Safety Defects

If you believe that your vehicle has a significant defect which could cause a crash or could cause injury or death, you should inform the National Highway Traffic Safety Administration (NHTSA) and Newmar Corporation.

To contact NHTSA, you may either call the Auto Safety Hotline toll free at 1-888-327-4236 (TTY #1-800-424-9153) or write to: NHTSA, 400 Seventh Street, S.W., Washington, DC 20590. NHTSA also has established a website where you can contact them:

<http://www.safecar.gov>

## Information Sheet

Newmar has enclosed an information sheet for your convenience. This sheet contains important information about your coach. The sheet can be found in the black literature bag provided with your unit. Listed on this sheet is the six digit Newmar Serial Number. This number is needed whenever making an appointment for service or ordering parts through your Newmar Dealer or Service Center. Also listed is the Vehicle Identification Number (VIN). The VIN is the legal identification of the completed vehicle and is used by the state for vehicle registration. Both of these numbers are also listed on the Customer Care card Newmar issues upon receipt of registration.

Below is a sample of the Information Sheet.

1. The Newmar Serial Number
2. Year/Brand/Type/Floorplan
3. Vehicle Identification Number (VIN)
4. Manufacturer, Model and Serial Number of factory installed equipment.

THANK YOU FOR PURCHASING A QUALITY NEWMAR PRODUCT! FOR YOUR CONVIENCE, WE HAVE ENCLOSED A SERIAL NUMBER LIST OF IMPORTANT EQUIPMENT INSTALLED IN YOUR 2005XXXXX####. THE SERIAL NUMBER FOR YOUR UNIT IS #####.

CLIMATE SYSTEM		SERIAL #		ENERGY MANAGEMENT SYSTEM		AWNING			
FRONT A/C	630615.321	33067		INVERTER	RV2012M	0062072	AWNING	8160P21	90064
CENTER A/C	630615.321	33068		CONVERTER			AWNING HDW	8551001	951
REAR A/C				GENERATOR	042702	20570	DOOR	40369888	356
DASH A/C	RV200675	6634		AUDIO/VIDEO/NAVIGATION				WINDOW 1	
FRONT FURN.	SF42	06990		FRONT TV	24FV300	60575	WINDOW 2		
REAR FURN.				REAR TV	20F5100	72234	WINDOW 3		
AUX HEATER				TV #3			WINDOW 4		
APPLIANCE				EXT. TV	4361270		WINDOW 5		
W/2				FRONT	20F19C		WINDOW 6		
							TO TOPPS		



# IMPORTANT RV TIRE INFORMATION

READ AND UNDERSTAND THE FOLLOWING INFORMATION BEFORE TAKING YOUR FIRST TRIP IN YOUR RV!



## WARNING

Routine maintenance on your RV is important, but it cannot be overstated just how critical proper tire maintenance is to the safety, operation, and durability of your new unit. To insure your tires are operating safely, regular inspection of your tires, and checking of tire pressures is absolutely mandatory. **FAILURE TO FOLLOW PROPER INFLATION GUIDELINES MAY RESULT IN TIRE FAILURE, WHICH, UNDER CERTAIN CIRCUMSTANCE CAN CAUSE LOSS OF VEHICLE CONTROL OR ACCIDENTS THAT MAY RESULT IN PROPERTY DAMAGE, BODILY INJURY, AND/OR DEATH.**

For safe operation and maximum weight carrying capacity, it is imperative that the tires be inflated to and maintained at the listed tire pressures on the Federal ID Tag that is affixed to the interior wall just behind the driver's seat in motorhomes, and to the lower front corner of the road side sidewall on fifth wheel trailers. Below is a sample of the Federal ID Tag you will find with your RV.

IT IS PARAMOUNT TO THE SAFE OPERATION OF THE VEHICLE TO MAINTAIN PROPER TIRE PRESSURES. TIRE PRESSURES SHOULD BE CHECKED AND ADJUSTED BEFORE AND AFTER EACH TRIP, AND SHOULD ALWAYS BE CHECKED AND ADJUSTED WITH THE TIRES COLD. NEVER ADD OR RELEASE PRESSURE FROM THE TIRES WHEN THEY ARE HOT (AFTER HAVING DRIVEN A MILE OR MORE).

For additional information on your tires, contact the Newmar Corporation.

MANUFACTURED BY / FABRIQUE PAR:		DATE:		
GVWR/PNBV		KG (	LB)	
FRONT/ AVANT	GAWR/PMBE KG (LB)	TIRES/PNEU	RIMS/JANTE	COLD INFL. PRESS./PRESS. DE GONFL. A FROID KPA SINGLE DUAL PSI(LPC) <input type="checkbox"/> <input type="checkbox"/>
INTERM/ INTERM	KG (LB)			KPA SINGLE DUAL PSI(LPC) <input type="checkbox"/> <input type="checkbox"/>
REAR/ ARRIERE	KG (LB)			KPA SINGLE DUAL PSI(LPC) <input type="checkbox"/> <input type="checkbox"/>
<p>THIS VEHICLE CONFORMS TO ALL APPLICABLE U.S. FEDERAL MOTOR VEHICLE SAFETY STANDARDS IN EFFECT ON THE DATE OF MANUFACTURE SHOWN ABOVE.          THIS VEHICLE CONFORMS TO ALL APPLICABLE STANDARDS PRESCRIBED UNDER THE CANADIAN MOTOR VEHICLE SAFETY REGULATIONS IN EFFECT ON THE DATE OF MANUFACTURE. - CE VEHICULE EST CONFORME A TOUTES LES NORMES QUI LUI SONT APPLICABLES EN VERTU DU REGLEMENT SUR LA SECURITE DES VEHICULES AUTOMOBILES DU CANADA EN VIGUEUR A LA DATE DE SA FABRICATION.</p>				
V.I.N./N.I.V.:		TYPE/TYPE:		FD-228

## SAFETY PRECAUTIONS



### WARNING

Prior to driving your vehicle, be sure you have read this entire owner's guide and that you understand your vehicle's equipment completely and how to use the equipment safely. Read and understand all of the instructions and precautions in this Owner's Guide and the chassis manufacturer Owner's Manual before operating your new motorhome. Listed below are some safety precautions that must be adhered to while your motorhome is in motion. These precautions, as well as others that involve possible damage to equipment, are also listed in the appropriate areas in this manual.



### DANGER

Any motorized vehicle or any motorized equipment powered with flammable liquid can cause fire, explosion, or asphyxiation if stored or transported within the recreational vehicle. To reduce the risk of fire, explosion, or asphyxiation:

- (1) Do not ride in the vehicle storage area while the vehicles are present.
- (2) Do not sleep in the vehicle storage area while vehicles are present.
- (3) Close doors and windows in walls of separation (if installed) while any vehicle is present.
- (4) Run fuel out of engines of stored vehicles after shutting off fuel at the tank.
- (5) Do not store, transport, or dispense fuel inside this vehicle.
- (6) Open the windows, openings, or air ventilation systems provided for venting the transportation area when vehicles are present.
- (7) Do not operate gas appliances, pilot lights, or electrical equipment when vehicles are present.

FAILURE TO COMPLY COULD RESULT IN AN INCREASED RISK OF FIRE, EXPLOSION, ASPHYXIATION, DEATH, OR SERIOUS INJURY.

### Before Starting Out

The following is a brief list of procedures that will aid in your driving safety and extend your equipment's life.

Windows, mirrors, and light lenses are to be clean and unobstructed.

Tires should be checked for proper cold inflation pressure.

Wheel lug nuts should be checked for proper tightness.

Fluid levels, including engine oil, transmission fluid, coolant, power steering fluid, brake fluid, and windshield washer solvent, should be checked and filled if necessary.

Disconnect the unit and store the sewer and water supply hoses as well as shoreline power cords.

Secure all cargo in the storage compartments in the event of a sudden stop.

Verify that the step has retracted prior to engine ignition.

### Driving

There are various adjustments that need to be made prior to starting and moving the vehicle.

Among them are the driver's seat, the tilt steering, and the exterior rear view mirrors.

The dashboard may contain several gauges and controls you have not previously used. Become familiar with all of these devices and their operation before starting out.

The cruise control is not to be operated on icy roads, extremely wet roads, winding roads, heavy traffic, or in any other traffic situation where a constant speed cannot be maintained.

While driving on slippery surfaces, use care when accelerating or decelerating. Skidding and loss of vehicle control may be the result of abrupt changes in speed.

Driving through water deep enough to wet the brakes may affect the stopping distance or cause the vehicle to pull to one side. If you have driven through deep water, check the brake operation in a safe area to be sure they have not been affected. Never operate a vehicle if a difference in braking efficiency is noticeable.

Extreme terrain and adverse weather may affect the handling and/or performance of your vehicle. Please refer to your chassis manual for related information.

## Propane & Fuel



### **WARNING**

Propane cylinders shall not be placed or stored inside the vehicle. Propane cylinders are equipped with safety devices that relieve excessive pressure by discharging propane to the atmosphere. FAILURE TO COMPLY COULD RESULT IN DEATH OR SERIOUS INJURY.



### **WARNING**

IT IS NOT SAFE TO USE COOKING APPLIANCES FOR COMFORT HEATING. Cooking appliances need fresh air for safe operation.

Before operation:

- (1) Open overhead vent or turn on exhaust fan
- (2) Open window

FAILURE TO COMPLY COULD RESULT IN DEATH OR SERIOUS INJURY.

Unlike homes, the amount of oxygen supply is limited due to the size of the recreation vehicle, and proper ventilation when using the cooking appliance(s) avoids dangers of asphyxiation. It is especially important that cooking appliances not be used for comfort heating, as the danger of asphyxiation is greater when the appliance is used for long periods of time.



### **WARNING**

DO NOT FILL PROPANE CONTAINER(S) TO MORE THAN 80 PERCENT OF CAPACITY. Overfilling the propane container can result in uncontrolled propane flow, which can cause fire or explosion. A properly filled container contains approximately 80 percent of its volume as liquid propane. FAILURE TO COMPLY COULD RESULT IN DEATH OR SERIOUS INJURY.



### **WARNING**

Portable fuel-burning equipment, including wood and charcoal grills and stoves, shall not be used inside the recreational vehicle. The use of this equipment inside the recreational vehicle can cause fire or asphyxiation. FAILURE TO COMPLY COULD RESULT IN DEATH OR SERIOUS INJURY.

 **WARNING**

DO NOT BRING OR STORE PROPANE CYLINDERS, GASOLINE, OR OTHER FLAMMABLE LIQUIDS INSIDE THE VEHICLE. FAILURE TO COMPLY COULD RESULT IN FIRE OR EXPLOSION

 **DANGER**

IF YOU SMELL PROPANE:

- (1) Extinguish any open flames, pilot lights, and all smoking materials
- (2) Do not touch electrical switches
- (3) Shut off the propane supply at the container valve(s) or propane supply connection
- (4) Open doors and other ventilating openings
- (5) Leave the area until odor clears
- (6) Have the propane system checked and leakage source corrected before using again

FAILURE TO COMPLY COULD RESULT IN EXPLOSION RESULTING IN DEATH OR SERIOUS INJURY.

 **CAUTION**

Propane regulators must always be installed with the regulator vent facing forward. Regulators that are not in compartments have been equipped with a protective cover. Make sure that the regulator vent faces downward and that the cover is kept in place to minimize vent blockage that could result in excessive propane pressure causing fire or explosion.

## Propane Gas System General Information

A warning label has been placed near the propane gas container. This label reads:

The propane gas system components in your unit have been approved for use in camping vehicles by a nationally recognized testing laboratory. Propane gas is a clean-burning dependable fuel when properly handled. The propane gas tank mounted on your unit contains liquid propane gas under high pressure. The liquid gas vaporizes as the fuel is used and passes through the tank valve to a regulator that automatically reduces the pressure. The low-pressure gas is then distributed to the appliances through the pipe manifold system. Appliance lighting problems are commonly caused by an improperly adjusted gas regulator. Never attempt to reset the regulator yourself. Have an authorized service technician make any necessary adjustments. We recommend that you have the propane gas system checked by an authorized service technician at least once a year and after every extended trip. Although the manufacturer and dealer carefully test for leakage, travel vibrations could loosen fittings. Leaks can be easily found by applying leak detector solution at the connections. If leak detector solution is not available, a soapy water solution made with dish soap can be used. Tightening the fitting usually stops any leaks. If this does not work, shut off the main gas valve at the tank and immediately consult an authorized service technician for repairs. If a leak is suspected, the identifying odor smells similar to rotten eggs (sulfur). Never test for a leak by lighting a match or having an open flame where you suspect leaking gas.

 **WARNING**

Shut off the main gas valve at the tank when the camping vehicle is not in use. Also, shut off the valve when refueling to avoid potential danger from pilot lights igniting fuel fumes. Some appliances, such as the refrigerator, water heater, and furnace, have DSI (direct spark ignition) boards, so it is important that you turn the appliances off when the PROPANE gas is off. The ignition in the appliances will continue to spark even if there is no PROPANE gas available.

## Propane Regulator

The regulator acts as the heart for the propane gas system. The propane gas in the tank is under high pressure. The regulator reduces the pressure of this gas so that it is safe to use with the various appliances in your unit. If corrosion is noticed, contact a qualified propane gas service technician. Do not adjust the regulator. It is factory preset. Adjustments are to be made by a qualified propane service technician using specialized equipment.

Propane gas regulators must always be installed with the diaphragm vent facing downward. Regulators that are not in compartments have been equipped with a protective cover. Make sure that the regulator vent faces downward and that the cover is kept in place to minimize the vent blockage that could result in excessive gas pressure causing fire or explosion.

## Propane Distribution Lines

The primary manifold is a black steel pipe running the length of your unit. Most secondary lines leading to gas appliances are made of copper tubing with flare fittings. If any of the gas lines rupture, do not attempt to splice them. Always run a new line. We recommend gas distribution work be performed by an authorized service technician. The main valve at the propane tank must be closed when removing or servicing any gas appliance. This will prevent dangerous gas leakage that could result in an explosion and possibly serious injury. If a leak is suspected, have the systems inspected and repaired by a qualified service technician.

## Precautions & Recommendations

Inspect the propane fill valve for foreign materials before refueling.

Shut the pilot lights off prior to refueling propane gas tanks.

Never check for gas leaks with an open flame (match, etc.).

Gas lines should be visually inspected periodically.

Have the gas system inspected yearly and before and after extended trips.

The gas system should be inspected and repaired by qualified technicians only.



### **WARNING**

The propane system in your recreational vehicle is designed for liquefied petroleum gas only. Never attempt to connect natural gas or butane gas in this system.

## Fire Safety

The possibility of fire exists in all areas of life, and the recreational life-style is no exception. Recreational vehicles are complex machines. They are made up of many materials, some of which are flammable. Like most hazards, the possibility of fire can be minimized, if not totally eliminated. This is done by recognizing the danger and practicing common sense safety and maintenance habits. For safety reasons, your unit is furnished with both a fire extinguisher and a smoke alarm.

## Fire Extinguisher

The fire extinguisher is rated for Class B (grease, gasoline, diesel fuel, flammable liquids) and Class C (electrical) fires. These are the most common types of fires in vehicles. Read the Operator's Manual and the instructions on the fire extinguisher. Be sure to know how and when to use the extinguisher and where it is located.

Fire extinguishers are mechanical, pressurized devices. Care must be exercised when they are handled. They must be maintained as the operator's manual instructs for proper and safe operation.

The extinguisher should be inspected at least once a month. More frequent inspections may be required if the extinguisher is exposed to the weather or to possible tampering. Do not test the extinguisher by partially discharging. Doing this will cause a loss of pressure.

If a fire occurs in the vehicle, evacuate the vehicle as quickly and as safely as possible. Consider the cause and the severity of the fire and the risk involved before trying to extinguish it. If the fire is major or fuel fed, move away from and stand clear of the vehicle and wait for emergency assistance to arrive.

### Smoke Detector

The battery powered smoke detector is mounted on the ceiling in the living area of the unit. Read the operating instructions for details on the testing and care for this important safety device. Test the smoke detector after the unit has been in storage, before each trip, and at least once a week during use. The detector should never be disabled because of nuisance or false alarm from cooking smoke or a dusty furnace.

Ventilate the unit with fresh air and the alarm will shut off. Never disconnect or remove the battery from the smoke alarm. The battery should be replaced once a year or when the low battery signal sounds.

### Emergency Exit Window

In the bedroom of the unit, there is an emergency exit (egress) window. This window is designed to be used as an additional exit in emergency situations. It can be easily identified by the red color of the handle and the red “EXIT” label. To open the egress window, lift the handle and push outward on the window. The window can be closed by pulling the window closed and lowering the handle to the down or locked position.

### Weight Information

Below is a sample of a weight information label which may appear in your unit.

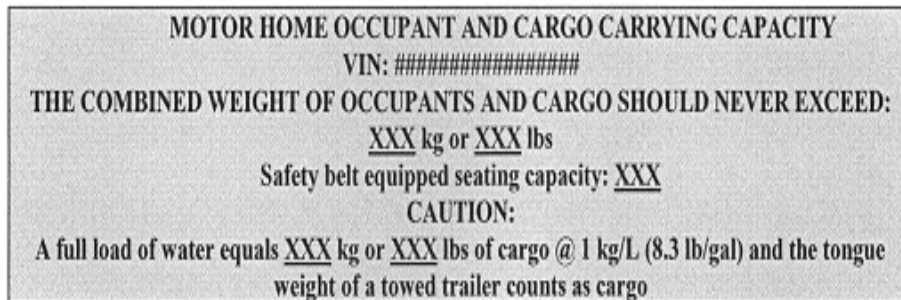

### Weighing the Unit

The following definitions are given to help in communications of issues of weight and your unit.

**GAWR:** Gross Axle Weight Rating is the maximum permissible weight for an axle.

**GCWR:** Gross Combination Weight Rating is the value specified by the manufacturer of the vehicle as the maximum allowable loaded weight of this motorhome and any towed trailer or towed vehicle.

**GVWR:** Gross Vehicle Weight Rating is the maximum permissible weight of this fully loaded motorhome. The GVWR is equal to or greater than the sum of the Unloaded Vehicle Weight plus the Cargo Carrying Capacity.

**UVW:** Unloaded Vehicle Weight is the weight of this motorhome as built at the factory with full fuel, engine oil, and coolants. The UVW does not include cargo, fresh water, propane gas, or dealer installed accessories.

**CCC:** Cargo Carrying Capacity is equal to GVWR minus each of the following: UVW, full fresh (potable) water weight (including water heater), full propane gas as weight and SCWR.

**GVW:** Gross Vehicle Weight is the weight of the unit with all items and supplies that are loaded into the unit at any point in time.

**SCWR:** Sleeping Capacity Weight Rating is the manufacturer's designated number of sleeping positions multiplied by 154 pounds (70 kilograms).

**NOTE:** The sales literature may give approximates or standards. Each individual unit may weigh differently based on the factory and/or dealer options added. To assure the accuracy of your weights be sure the unit is always level during weighing. The unit has been built to comply with the component suppliers recommended limits and give you a realistic CCC. When loading the unit, distribute the items so that not all of the weight is added to one area of the unit. If you have questions as to what the weight of the unit is after it has been loaded, take the unit to a drive-on scale or use individual wheel scales and verify that the weights are within the limits of those specified for the unit. When weighing the unit, follow these instructions. Failure to follow these instructions may give an erroneous weight reading.

1. Pull the unit onto the scales shown in Fig. 1. This is the total weight of the unit. To do this, pull the unit onto the scales so that all of the wheels are on the scale. Record the weight. This is the GVW and should not exceed the GVWR supplied by Newmar for the unit.
2. Move the unit so that the front wheels are off the scales as shown in Fig. 2. Record the weight. This is the total weight of the unit except for the front axle. This weight should not exceed the total rating of the axles remaining on the scales. The front axle weight is determined by subtracting this weight from the GVW that was obtained in Step One (1). This amount should not exceed the listed front axle weight rating.

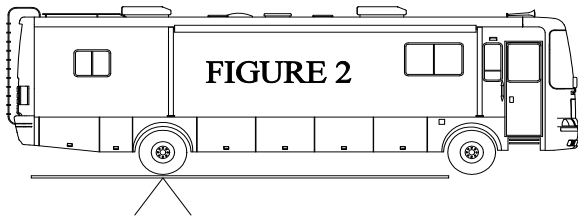
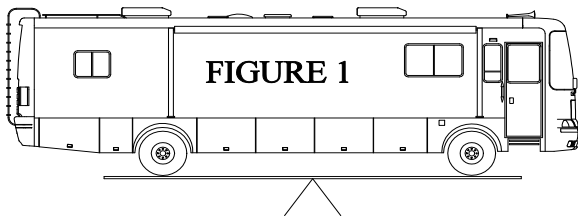

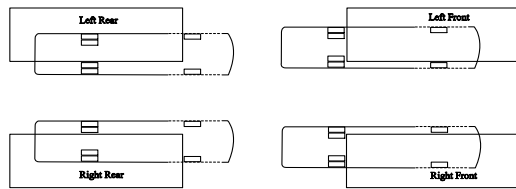

The recommended procedure to weigh a motorhome accurately is on individual corner scales. Since these are not always available, below is a diagram of how to weigh a motorhome on a typical truck scale.

Note: Since only one corner can be weighed at a time, the remaining three corners need to be as close to the scale as possible without being on the scale and the unit needs to be as level as possible. Remember, wind and rain can cause inaccuracies of weights.

### **IMPORTANT**

Your RV has been aligned at the factory as part of the production process. To provide optimum tire longevity and offer the best handling characteristics, Newmar recommends you have your unit re-aligned **after** loading your belongings as you would travel. Though highly recommended, this alignment is not mandatory, and as such is not warrantable by Newmar or the chassis manufacturer.

### **Campsite Parking**

If the campground does not have drive-through sites, it is recommended to stop near the site and inspect it for slopes or uneven areas. Carefully back into the campsite. Watch for low-hanging limbs, posts, large rocks, or other obstacles. Back the unit in so the site is on the driver's left, if possible. This will enable the driver to watch the rear of the unit. Back up slowly using the side mirrors as a guide or with the assistance of another person outside guiding the parking procedure.

Place the vehicle in park and turn off the ignition. If parked on a steep incline, pre-level the coach by driving the appropriate wheels onto blocks. Finish the leveling process by using the leveling jack system to level and stabilize the unit. Connect the 120 volt shore power to the unit. Open the propane gas valves at the propane tanks. Connect the fresh water supply and sanitize the water systems, if necessary. Connect the waste drain hose to the sewer hook-up. Start the refrigerator, water heater, and furnace, if needed. Light the oven pilot light, if applicable. Remember that the refrigerator will not operate efficiently if the unit is not level.

### **CAUTION**

Do not lift the wheels of the unit off the ground at any time during this process. The unit can roll forward or backward when the weight of the unit is on the jacks.

### **Car Towing Hitch**

The motorhome is equipped with a towing hitch and wire connector. Two extra 14 gauge wires are also included for your use. Your unit is designed for use as a recreational vehicle and is intended for towing light loads. The instructions for towing are listed in the chassis manufacturer Owner's Manual provided with your unit. The total weight of the motorhome and any vehicle towed by it must not exceed the GCWR (Gross Combined Weight Rating). Remember, when planning to tow, approaching the GVWR (Gross Vehicle Weight Rating) may reduce the motorhome's towing capacity.



When weighing the motorhome, be sure to take passenger locations into consideration. The towed vehicles must have adequate active brakes. All towed vehicles of 1,500 pounds or more must have independently active brakes. Please contact your state Department of Transportation or your local Newmar dealer for your state requirements. The wire connector installed is the standard seven-pin connector. Chapter 4 of this guide will have more information regarding this connector.

## **IMPORTANT**

Prior to towing, inspect all towing connections, including hitch mounting bolts for unusual wear or corrosion, visually checking for deformation of the mounting flanges and cracked welds on the hitch itself or any other sign of movement or fatigue in the hitch assembly. Safe and satisfactory performance of the towing system depends in large part on the type of towing equipment connected to the hitch receiver. The assembled length of the drawbar/towing system used should be kept to a minimum. Newmar is not responsible for damage or failure of the hitch receiver caused by the use of excessively long drawbars or other styles of drawbars that create leverage loads on the hitch receiver beyond its designed capabilities.

## **Occupant Restraints**

One of the most important safety features in your vehicle is the restraint system. Research has shown that seat belts save lives. And they can reduce the seriousness of injuries in a collision. Some of the worst injuries happen when people are thrown from the vehicle.

**EVERYONE IN A MOTOR VEHICLE NEEDS TO BE BUCKLED UP ALL THE TIME.**

## **WARNING**

It is extremely dangerous to ride in a cargo area, inside or outside of a vehicle. In a collision, people riding in these areas are more likely to be seriously injured or killed.

Do not allow people to ride in any area of your vehicle that is not equipped with seats and seat belts. **BE SURE EVERYONE IN YOUR VEHICLE IS IN A SEAT AND USING A SET BELT PROPERLY.**

Please pay close attention to the information in this section. It tells you how to use your restraint system properly.

If you wear your safety belt improperly, both the effectiveness and comfort will decrease.

- Do not allow the buckle to be located in the stomach or abdomen area.
- Do not wear the shoulder strap under your arm or behind your back.
- Do not wear the shoulder belt too snug, or let it rub against your neck.
- Do not allow the belts to become too loose as you travel  
If the lap and/or shoulder belts are too loose, they may not be able to hold you in place during a crash.
- Do wear the lap belt low on the hips, two to four inches below the waist, and against the thighs. The strong bones of the hips can absorb the forces experienced in a crash.
- Do wear the shoulder strap across the center of the chest and the center of the shoulder.

## **Lap/Shoulder Belt Operating Instructions**

1. Enter the vehicle and close the door. Sit back and adjust the seat.
2. The latch plate of the belt is above the back of your seat. Grasp the latch plate and pull out the belt. Slide the latch plate up the webbing as far as necessary to make the belt go around your lap.
3. When the belt is long enough to fit, insert the latch plate into the buckle until you hear a “click.”
4. Position the lap belt across your thigh, below your abdomen. If you need the lap portion tighter, pull up a bit on the shoulder part. A snug belt reduces the risk of sliding under the belt in a collision. Position the shoulder belt on your chest so that it is comfortable and not resting on your neck. The retractor will withdraw any slack in the belt.
5. To release the belt, push the release button on the buckle.

## **Adjustable Upper Shoulder Belt Anchorage**

Some shoulder belts can be adjusted upward or downward to help position the belt away from your neck. Push on the anchorage cover to release the anchorage, and then move it up or down to the position that serves you best.

## **Child Restraint**

Everyone in your vehicle needs to be buckled up all the time. Every state in the United States and all Canadian provinces require that small children ride in proper restraint systems. This is the law, and you can be prosecuted for ignoring it.

There are different sizes and types of restraints for children from newborn size to the child almost large enough for the adult seat belt. Use the restraint that is correct for your child:

- The restraint must be appropriate for your child's weight and height. Check the label on the restraint for this, too.
- Carefully follow the instructions that come with the restraint. If you install the restraint improperly it may not work when you need it
- Buckle the child into the restraint exactly as the manufacturer's instructions tell you.

## **MAINTAIN YOUR RESTRAINT SYSTEM**

Periodically examine your restraint equipment to be sure it functions correctly and to be sure there are no worn or broken components that either needs repair or replacement. Damaged parts must be replaced immediately. Do not disassemble or modify the system.

Restraint equipment must be replaced after an accident if they have been damaged. If there is any question regarding belt or retractor condition, replace the belt.

It is a good idea to have your restraint system inspected during each periodic scheduled maintenance session.

 **WARNING**

A frayed or torn belt could rip apart in a collision and leave you with no protection. Inspect the belt system periodically, checking for cuts, frays, or loose parts. Damaged parts must be replaced immediately. Do not disassemble or modify the system. Seat belt assemblies must be replaced after an accident if they have been damaged (bent retractor, torn webbing, etc.)

**Safety Belt Maintenance**

If the belts need cleaning, use a mild soap solution or lukewarm water. Do not remove the belts from the vehicle to wash them.

 **WARNING**

Do not bleach, dye or clean the belts with chemical solvents or abrasive cleaners. This may severely weaken the fabric. In a crash, they might not be able to provide adequate protection.

# HVAC, APPLIANCES & ACCESSORIES

## HEATING & AIR CONDITIONING

### Air Conditioning

The following is a brief overview of the operation of the Dometic Comfort Control 2 Center. For additional information, please refer to the Dometic Comfort Control Center 2 Thermostat Operation Instructions included in the appliance information packet in your coach.

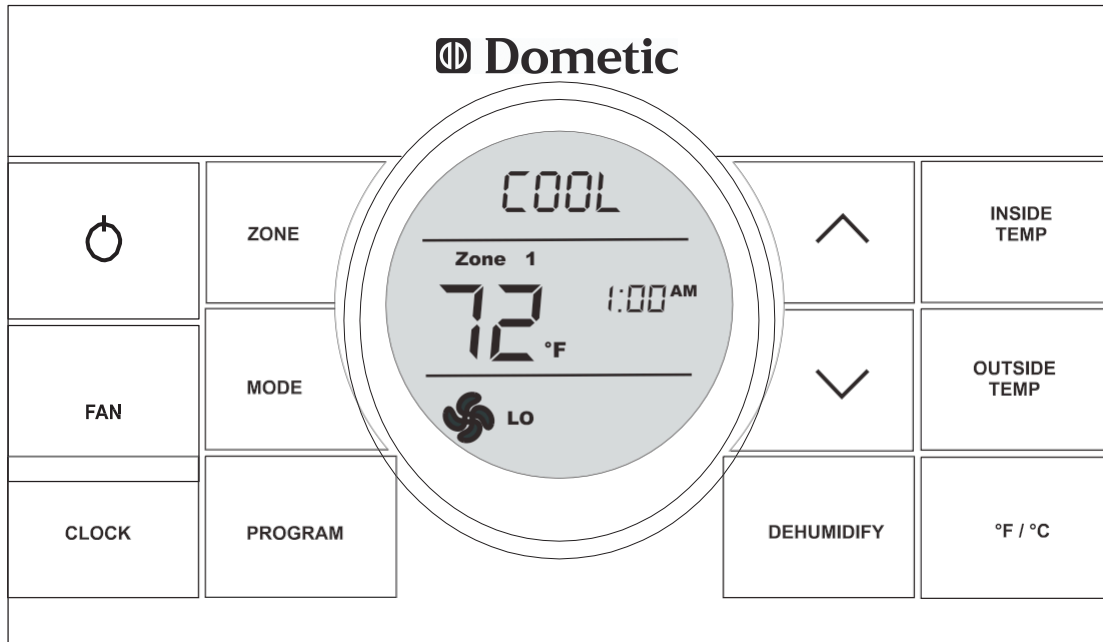

### Quick reference to control buttons

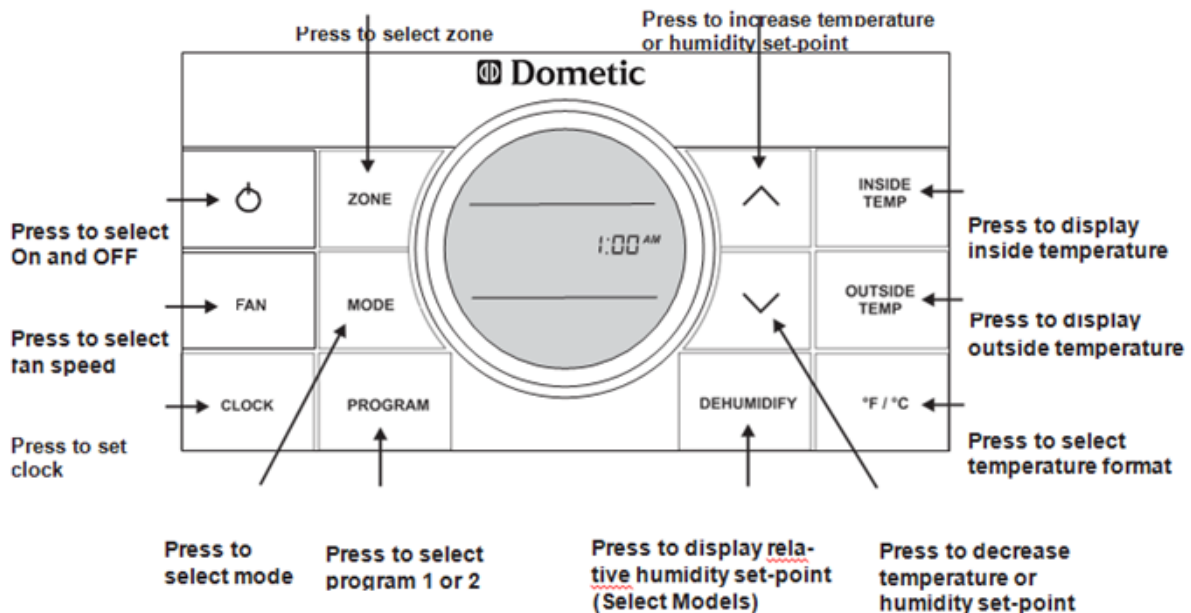

## Clock Setting

Press the **CLOCK** button to initiate the clock setting sub-menu on the CCC 2 thermostat. When in this menu, the **hour** digits will flash first. The hour can be adjusted using the  $\wedge$  or  $\vee$  buttons. Press the **CLOCK** button again and the **minute** digits will flash, allowing the minute setting to be adjusted using the  $\wedge$  or  $\vee$  buttons. Press it a third time and the **AM** or **PM** icon will flash, allowing the AM or PM setting to be adjusted using the  $\wedge$  or  $\vee$  buttons. Press it one more time to store the new time in memory and exit the clock setting sub-menu.

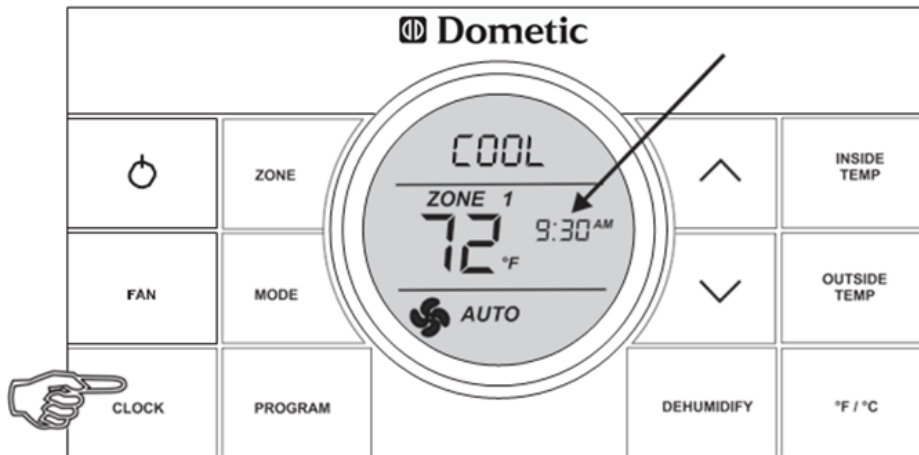

## Temperature format °F / °C

Press the **°F / °C** button to switch between Fahrenheit and Centigrade format. °F indicates Fahrenheit and °C indicates Centigrade

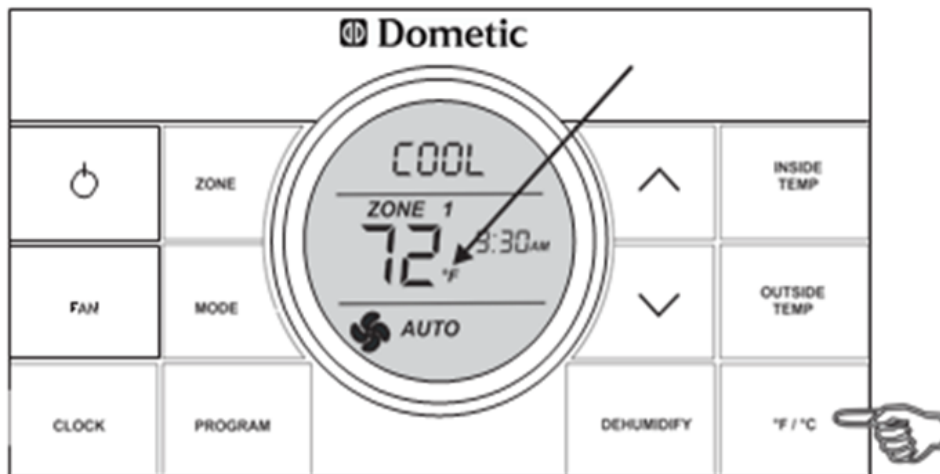

## Inside Temperature

Press and hold the **INSIDE TEMP** button and the LCD will display the current inside temperature recorded at the CCC 2 Thermostat (or at the optional remote indoor temperature sensor) instead of the temperature set-point. The LCD will also display “**IN**” to indicate that the inside temperature is being displayed. When the **INSIDE TEMP** button is released, the LCD will return to the programmed temperature set-point.

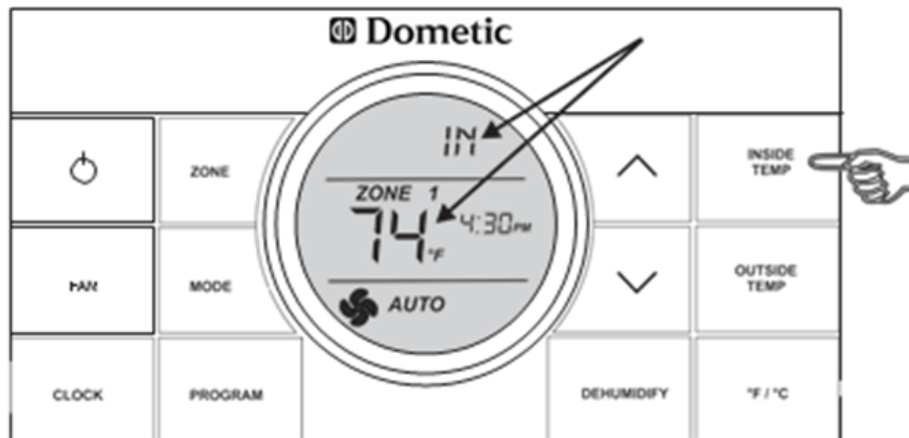

## Outside Temperature

Press and hold the **OUTSIDE TEMP** button and the LCD will display the current outside temperature recorded at the outdoor temperature sensor in place of the temperature set-point. The LCD will also display “**OUT**” to indicate the outside temperature is being displayed. When the **OUTSIDE TEMP** button is released, the LCD will return to the programmed temperature set-point.

The outside temperature sensor is located in the roof top unit. The CCC 2 thermostat temperature measuring range is between -5° F and 105° F. When the roof top unit is exposed to direct sunlight, the upper limit of the CCC 2 thermostat could be reached even though the actual outdoor temperature is lower than 105° F. Outside temperatures above 105° F will be displayed as 105° F.

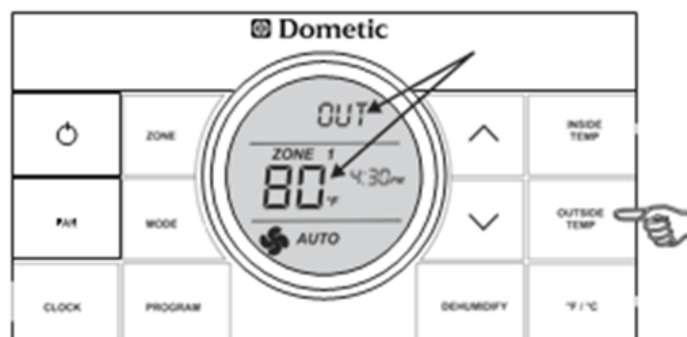

## Zone Selection

Press the **Zone** button to cycle the LCD display through the available zone selections; Zone 1, Zone 2, Zone 3, and Zone 4. Only the available zones installed within your system will display. See “**Special Features**” on page 8 for more information on zones.

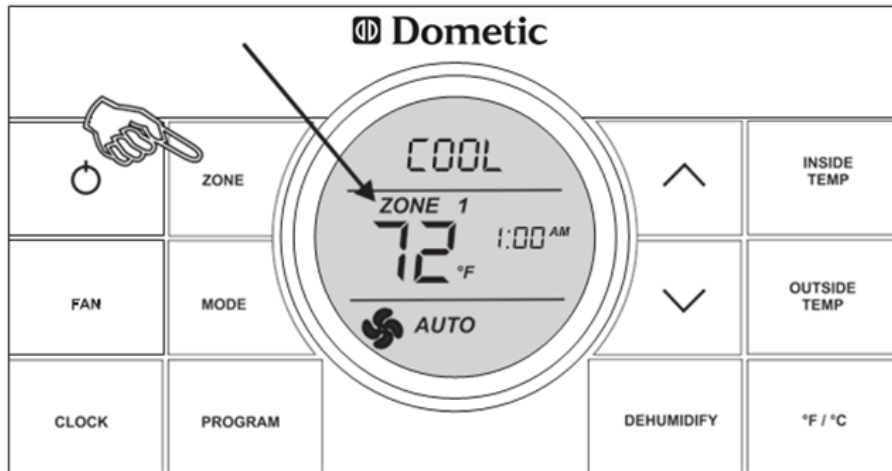

## Fan Speed

Press the **FAN** button to select the desired fan speed. Each successive press will advance to the next available speed. Your selections will be Auto, LOW, MED, and HIGH. The fan will run continuously during LOW, MED, and HIGH fan settings. The fan will cycle on and off with the thermostat on AUTO setting. See “**Special Features**” on page 8 for more information on auto fan.

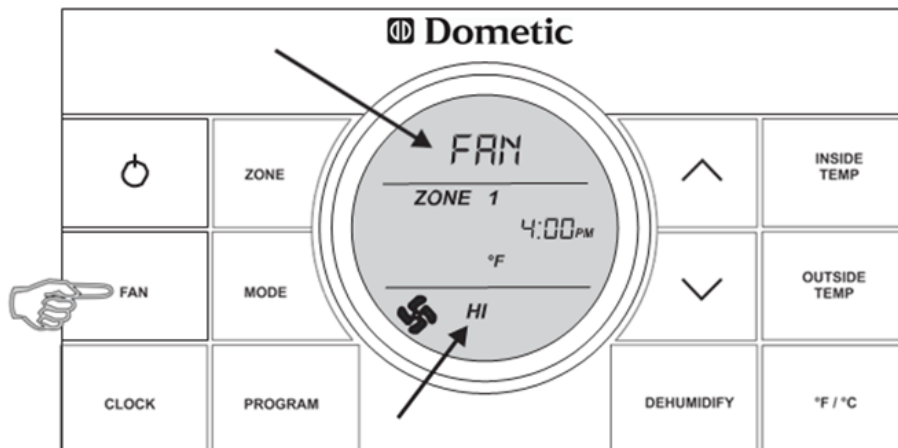

## Mode Selection

Press the **MODE** button and the LCD will display the first available mode. Each successive press will advance to the next available mode. Continue to press the **MODE** button until the desired mode appears. Depending on the systems installed, your choices will be OFF, COOL, AUTO, HP, FURN or AQUA, HS, and FAN. See “**Mode Description**” on page 6-7 for more information on modes.

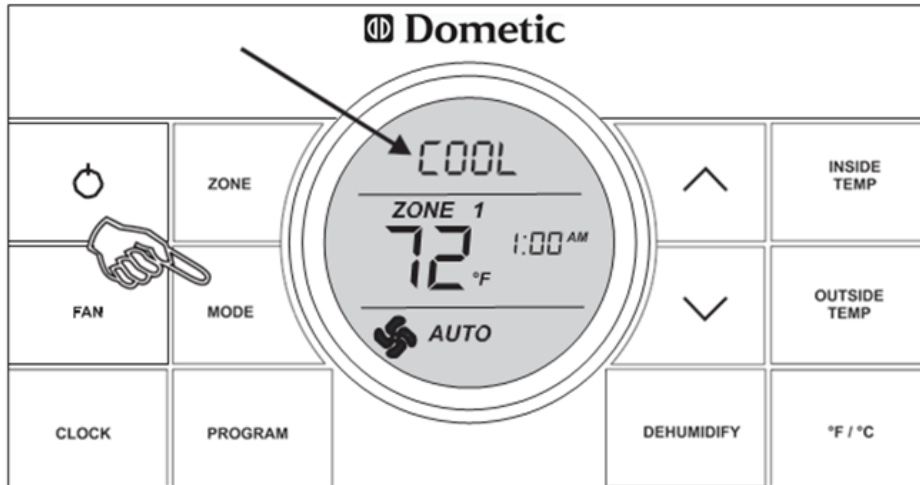

Heating

## Temperature Set-Point



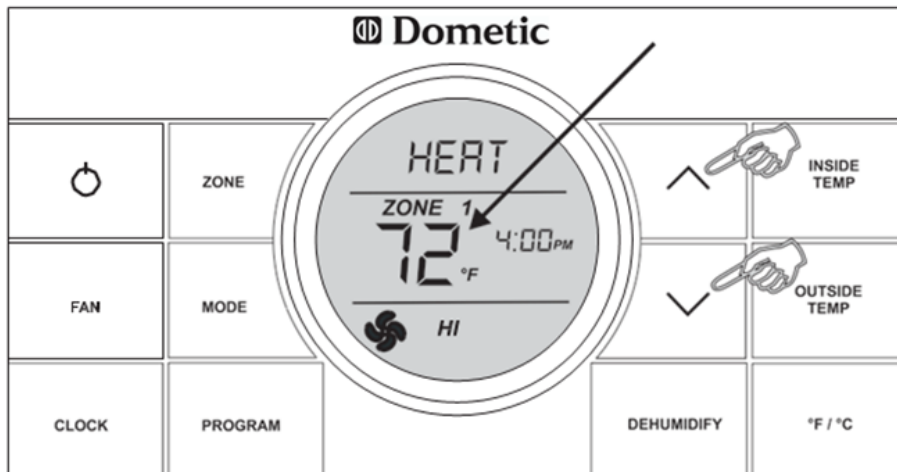

Press the  $\wedge$  or  $\vee$  button to change the temperature set-point. The temperature set-point is indicated by two digits on the LCD. Press  $\wedge$  to increase and  $\vee$  to decrease the temperature set point. The maximum set-point for the system is 90° F. The minimum set-point is determined by the active operating mode. For heating, the minimum is 40° F. and minimum for cooling is 55° F.





## Dehumidify Setting (Select Models)

**Note:** To set the dehumidify set-point, the system will need to be in a mode other than OFF.

Press the **DEHUMIDIFY** button. The LCD will display the “**dEHm**” icon, the water droplet icon   , and the humidity set-point. The set-point can be adjusted in 5% increments from 35% to 70%. Press the  button to increase the set-point and the  button to decrease the set-point. To disable the dehumidify operation, press and hold the **DEHUMIDIFY** button for three (3) seconds. The water droplet icon will be turned off and returns to the previous settings.

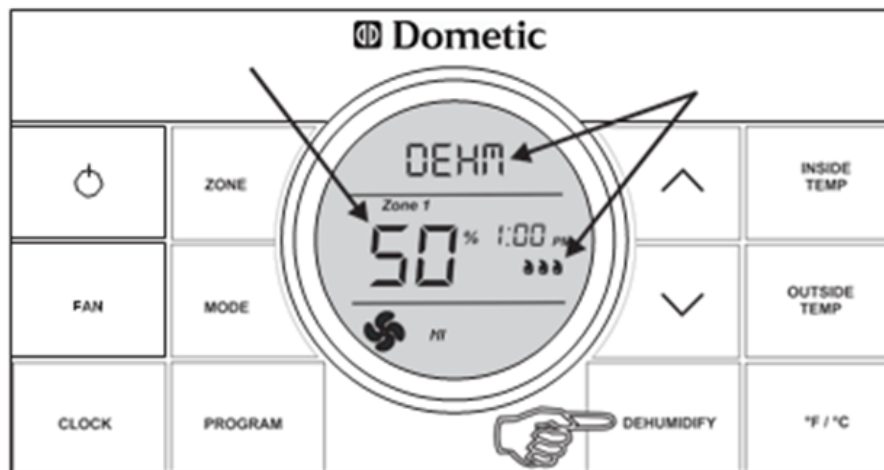

## FURNACE

### WARNING

Never attempt to modify this furnace. Fire, explosion, asphyxiation, or carbon monoxide poisoning may occur. If the furnace malfunctions, consult a trained service technician.

### WARNING

Portable fuel burning appliances are not safe for heating inside the recreational vehicle. Asphyxiation or carbon monoxide poisoning can occur.

## Heating - Oasis

For your comfort, your new Dutch Star may be equipped with the Oasis heating system. This system uses a “boiler” and a pump to heat and recirculate hot fluid through a series of convectors placed strategically throughout your unit. Fans located on the convectors provide circulation of the warmed air for more even, efficient heating.

The Oasis system uses two different sources for heat. The first, and most efficient, is the diesel burner. This uses diesel fuel from the motor homes fuel tank to burn and create heat. The second heat source is an electric heating element. It is important to note the difference in the two systems.

The output of the diesel burner is 50,000 BTU's. This is the primary heat source for the Oasis system. The electric heating element has a 5000 BTU output, and should be used only to help maintain the temperature once the diesel burner has brought the system up to proper operating heat levels. From a cold start, the 5000 watt electrical heating element will not operate the system alone.

For heating, your unit is divided into three "zones" on your Comfort Control thermostat. The "Furnace" mode will appear in all four zones, but only three are active. They are as follows:

**Zone 1:** Dash and Kitchen Convector: These convectors are located under the dash and kitchen cabinets, and control heat in the dash, living room, and kitchen areas. Note that the dash mounted convector is the only one in your unit that has a two speed fan. The switch controlling the fan speed is located in the front overhead cabinet adjacent to the diesel boiler switch.

**Zone 2:** No Furnace Operation: There are no "Furnace" functions on this zone.

**Zone 3:** Bathroom Convector: These convectors are located in the bathroom cabinetry and stool room. Please note that the fan switch for the stool room (marked "HEAT") must be in the "ON" position to get heat in the stool room. It should also be noted that for Stool Room heat, a "rear" zone (bathroom or bedroom areas) must be chosen on the CCC thermostat.

**Zone 4:** Bedroom Convector: These convectors are located throughout the cabinetry and walls of the rear bedroom area.

To activate the Oasis heating system, select your heat source, either diesel or electric, using the switches in the front overhead cabinet.

Once you have selected your heat source (diesel or electric), and the boiler is operational, Comfort Control Thermostat to select "Furnace" in the zones you want to heat. Remember, as described above, Zone 2 will display a "Furnace" function, but the thermostat controls no functions in Zone 2 when in the "Furnace" mode.



### **IMPORTANT**

The Oasis "diesel burner" heat source provides approximately 50,000 BTU's of heat, and is designed to start up and operate the system to its full capacity. The electrical heating element provides approximately 5000 BTU's of heat.

The system will turn convector fans off and on according to the temperature settings in all but two locations. In those locations, the fan control is separate for independent operation. The first location is at the dash. The convector fan under the dash is operated by a switch in the front overhead compartment. It has settings for on, off, and speed selections.

The second convector fan that is controlled independently is in the "stool room" in the bathroom area. It is controlled by the wall switch labeled "Heat", and allows the occupant to tailor the room temperature to their comfort separately from the rest of the bathroom.

## Propane Tank

This unit is equipped with an ASME (American Society of Mechanical Engineers) approved propane tank. This tank is controlled with an automatic pressure regulator. The propane tank contains liquid petroleum gas under high pressure. As the fuel is used, the liquid gas vaporizes and passes through the tank valve to a regulator that automatically reduces the pressure. The low-pressure gas is then distributed to the appliances throughout the pipe manifold system. Improperly adjusted regulators are the major cause of appliance lighting problems. Never attempt to reset the regulator. This is to be done by a qualified service technician. While in high altitudes or extreme cold weather a gas shortage may be experienced. Running one appliance at a time can help adjust to this problem.

It is recommended to have the propane system inspected by an authorized service technician at least once a year and after every extended trip. This system is tested by both the manufacturer and the dealer. Leaks can be caused by travel vibrations; therefore routine inspections are recommended.

The primary gas supply manifold is a black steel pipe running the length of the unit. Most secondary lines leading to the gas appliances are made of copper tubing with flare fittings. If any of these lines rupture, do not attempt to splice them. Always have a new line run. Gas distribution work must be performed by an authorized service technician. When removing or servicing any gas appliance, close the main gas valve at the propane tank. This will prevent dangerous gas leakage that could result in an explosion and possible serious injury. If a gas leak is suspected, have the system inspected and repaired by a qualified service technician as soon as possible.

### **WARNING**

The main gas valve must be shut when the vehicle is not in use. Shut the valve off when refueling to avoid potential danger from pilot lights igniting fuel fumes. Gas valves on appliances with direct spark ignition (DSI) should also be in the off position. Do not store propane, gasoline, diesel, or other flammable liquids inside the vehicle. Fire or an explosion could be the result of ignoring this warning.

## Propane Tank Filling

Do not fill the tank to more than 80 percent of capacity. The unit must be level when filling the propane tank. If unlevel, overfilling may occur. Fire or explosion may be the result of uncontrolled gas flow from an overfilled tank.

## Propane Regulator

The regulator is the heart of the propane system. The regulator reduces the pressure of the gas so it is safe to use with various appliances. Regulators are equipped with a vent. In the event excess pressure builds up in the body of the regulator, a relief mechanism vents it to the atmosphere. It will vent until the pressure returns to the normal range. The vent must be kept clean and clear of obstructions or corrosion. A clogged vent could cause the failure of components. Contact a qualified propane technician if corrosion or obstruction is noticed.

The presence of moisture in propane fuel causes the regulators to freeze. The moisture will pass through the cylinder valve and into the regulator where freezing occurs. To help prevent the regulator from freezing, always keep the tank control valve closed when not in use, even when the tank is empty, to prevent moisture from collecting on the inside.

If moisture becomes a problem, consult an authorized propane service center for assistance.

The regulator must always be installed with the diaphragm vent facing downward. Please refer to Chapter 2 of this manual for further propane gas safety information.

## Propane Leak Detector

### **WARNING**

Never check gas lines for leaks with an open flame. Do not check for leaks using ammoniated or chlorinated household type detergents. These detergents can cause cracks to form on the metal tubing and brass fittings. Take the unit to a qualified propane gas service technician to find and repair the leak. Keep the tank valve closed and all of the appliances turned off when the unit is stored. If any of the propane gas valves do not close leak-tight by hand, consult a service technician.

Liquid propane (propane) gas is heavier than air and will settle to the lowest point of the room, which is generally on the floor of your coach. Because of this, the propane detector installed in your coach is located near the floor. The detector is also sensitive to other fumes, such as hair spray, which contain butane as the propellant. Butane, like propane, is heavier than air and will settle to the floor level where it may be detected. When this occurs, press the reset button to stop the alert sound for 60 seconds.

The detector is equipped with a “sensor activation strip.” This strip must be removed for the detector to operate properly. This should have been done during the dealer’s Pre-Delivery Inspection. Please check the detector to verify that the activation strip has been removed.

Please consult your propane detector User’s Guide for more detailed information.

## MAJOR APPLIANCES

### Refrigerator

Before starting the refrigerator, verify that the main propane gas valve is in the on position. The refrigerator is equipped with a semi-automatic energy selector (AES) control system. It can be set to select either 120 volt or propane gas operation, automatically, if desired.

### **WARNING**

Most propane gas appliances used in recreational vehicles are vented to the outside of the vehicle. When parked close to a gasoline pump it is possible that the gasoline fumes could enter this type of appliance and ignite the burner flame causing a fire or explosion. Use caution when refueling.

A 12 volt power supply must be available for the electronic control panel to function. The shore line must be plugged in, or the optional generator running, to operate in the 120 volt mode. The main propane gas valve must be open for operation in the propane mode. To start the refrigerator, press the main power ON/OFF button to the ON position.

To use the 2-way Auto Mode, push the AUTO/GAS mode selector into the ON position. If 120 volt is available, the AC mode indicator light will be illuminated designating AC operation. If 120 volt is not available, the gas mode indicator light will be illuminated. The control system will automatically switch to gas operation. To operate on gas only, push the AUTO/GAS mode selector until the gas indicator light has lit. After 45 seconds the burner should be ignited and operating normally. The initial startup may take longer than 45 seconds in order to allow the air to be purged from the gas line.

If the gas does not ignite within 45 seconds, the check indicator light will illuminate and the gas mode light will go off. If the check indicator light illuminates and the gas mode indicator light is off, then the controls have failed to ignite the burner in the gas mode.

When the check indicator light is on, press the main power ON/OFF button to the off position to reset. Do not continue to reset the gas operation if the check indicator light continues to illuminate after several tries.

The thermostat on the refrigerator controls the gas and electric operation. This eliminates the necessity of resetting the temperature each time a different energy source is used. Press the temperature selector button until the light at the desired setting is illuminated. After the initial startup, the thermostat should be moved from the coldest setting to the desired setting, which is usually mid-range.

An optional feature on the refrigerator may be the installation of the automatic icemaker in the freezer compartment. Depending on the floorplan of your unit, additional refrigerator options may include a four door refrigerator, a 10 cubic foot refrigerator, or a side-by-side refrigerator. For detailed operating instructions, please consult the manufacturer Owner's Manual in the Owner's Information Package.

## Microwave

A microwave is installed in your coach as part of the standard equipment package. In place of the standard microwave, a 30" convection microwave may be optioned. All microwaves operate on 120-volt electricity. The microwave's control panel is the touch pad type. Simply enter the temperature, mode, and cooking time desired. For instructions on how to operate any of the special features on the microwave oven, please refer to the microwave Owner's Manual in your Owner's Information Package.

## Range Hood

A range hood may be incorporated into the microwave. The microwave's control panel operates the range hood functions. This range hood has both a fan and a light for your convenience. The fan has two speeds which are low and high. Simply select the desired setting from the microwave's control panel. For further detailed information on the hood operation, refer to the microwave Owner's Manual.

## Range

Your unit is equipped with a three-burner recessed range with a glass oven door and piezzo ignition. There is no pilot light for the range. There are different models used in the Newmar product line with different types of controls. To light the burners on some models, turn the control knob to turn the gas on. Wait a couple of seconds, and then push the red spark button until a flame appears. On other models turn the spark control knob until a flame appears. All burner controls operate counter clockwise and have to be pushed inward in order to turn. On units with an oven, the oven control must also be pressed inward before turning. To light the oven, push in the oven control knob and rotate counter clockwise to the PILOT ON position. Light the oven pilot light located at the back left-hand side of the oven burner. The oven pilot may be slow in lighting due to initial air in the gas line. The oven pilot has been factory adjusted. No further adjustments are necessary. To extinguish the oven pilot, push in the oven control knob and turn clockwise to the "Off" position.

Your range may be equipped with a bi-fold range cover that matches your countertop material. This cover helps to protect the burners when they are not in use. Before cooking on the range top, the cover must be in the full upright and folded position, preventing the cover from falling on the range top during cooking. Never close the cover while the burners are in use and do not use the cover as a griddle. Never use the range while the RV is moving and remember to close the bi-fold cover when the range top is not in use.

For further instructions, please refer to the oven manufacturer Owner's Manual in your Owner's Information Package.

The following warning label has been placed in the cooking area to remind the user to provide an adequate supply of fresh air for combustion:

 **WARNING**

It is not safe to use cooking appliances for comfort heating. Cooking appliances need fresh air for safe operation.

Before operation:

1. Open overhead vent or turn on an exhaust fan.
2. Open a window.

Unlike homes, the amount of oxygen supply is limited due to the size of the recreational vehicle. Proper ventilation when using the cooking appliance(s) will avoid dangers of asphyxiation. It is especially important that cooking appliances not be used for comfort heating as the danger of asphyxiation is greater when the appliance is used for long periods of time.

The following label has been placed in the vehicle near the range area:

**If You Smell Gas:**

1. Extinguish any open flames, pilot lights, and all smoking materials.
2. Do not touch electrical switches.
3. Shut off the gas supply at the tank valve(s) or gas supply connection.
4. Open doors and other ventilating openings.
5. Leave the area until the odor clears.
6. Have the gas system checked and leakage source corrected before using again.

**Television Antenna**

A TV antenna is installed on your coach. If the reception is poor, you should verify that the power switch is in the "ON" position and that all of the connectors are tight. If poor reception still occurs, consult your authorized dealer.

To raise the antenna into the operating position, turn the elevating crank (clockwise) in the "UP" direction, about 13 turns, or until some resistance to turning is noticed. On the power booster, turn the switch to "ON" in order to amplify the signal being received. Once in the "UP" position, rotate the antenna to receive the best picture. This is done by pulling down on the directional handle with both hands until it disengages from the ceiling plate and then rotating it until reception has improved.

The antenna must be lowered before moving the vehicle. To lower, rotate the directional handle until the pointer is aligned with the pointer on the ceiling plate. Turn the elevating crank (counter-clockwise) in the "DOWN" direction, about 13 turns, or until some resistance to turning is noticed. The antenna is now locked and in the travel position. Your unit may be equipped with one exterior antenna jack and two interior antenna jacks.

RAISING ANTENNA TO OPERATING POSITION

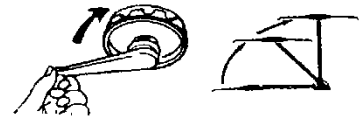

ROTATING ANTENNA FOR BEST PICTURE



LOWERING ANTENNA TO TRAVEL POSITION

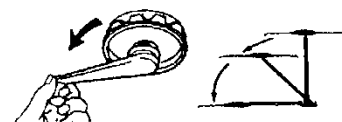

## CAUTION

Under no circumstances should you lower the antenna in any position except the travel position.

### Television

The coach is cable ready, and (depending on floorplan) as standard equipment may have a flat panel color television in the living area and in the bedroom. The televisions are powered by 120 volt electricity.

Your coach must be plugged into shore power, have the generator running, or have the inverter operating in order for the television to work. For more information on this, see Chapter 4 of this manual. The television operation is similar to most televisions used in the home. The main unit has the basic ON/OFF, Volume UP and DOWN, Channel UP and DOWN, and Menu UP and DOWN. The remote control has these in addition to many other function keys. Your unit may also be pre-wired for a satellite system. Your unit may be equipped with one interior television jack and an exterior television jack located on the door-side of the coach. Please consult your television owner's manual for further information. As an option, an external entertainment center that includes a flat screen television and an AM/FM compact disc player and radio may be added. All TV source selection is achieved through the TV's input selection mode. Please refer to the Television's Owner's Guide for additional information. The Living area DVD and Satellite, if equipped, provides input to the front TV(s) and Exterior Entertainment TV, if installed. The Bedroom area DVD and Satellite receiver, if equipped, provides input into the Bedroom area TV.

## IMPORTANT

TV's in the front overhead cabinet will not operate when in transit. Federal regulations require these TV's be inoperative while the vehicle is in use, so the power supply to this TV is switched off automatically when the ignition is on.

To enhance the entertainment experience in your unit, a DVD and Surround Sound Stereo Receiver system may be installed. This system allows you to enjoy music, TV, or videos from DVD through a matching set of speakers, complete with a subwoofer for deep, full bass sound. This system has its own remote, and detailed operating instructions can be found in the manufacturer's literature that was provided with your unit.

### Cable & Telephone Jack

An exterior cable jack and receptacle may be features on this coach. If installed, these may be located in an outside storage compartment. Another feature on this coach is the telephone hook up. This would allow the user to connect the coach to a telephone cable, if the park is so equipped. This feature includes the connector for the incoming telephone line and two telephone jacks inside the coach. As an option, an extra interior telephone jack may be added.

### Exterior Entertainment Center (optional)

Your unit may be equipped with an optional Exterior Entertainment Center, located in a basement compartment on the passenger side, just forward of the rear wheels. This Entertainment Center has a flat panel television mounted on a pivoting "swing arm" that allows you to rotate the TV for optimum viewing.

Simply grasp the TV and pull it toward you to release it. Return it securely to the stored position prior to closing the compartment door and traveling. Programming is provided to this television through the “TV3” button on the Video Control Center.

The Exterior Entertainment Center also incorporates a stereo system that allows you to enjoy music, or TV sound through the exterior speakers.



## **IMPORTANT**

It is important to make sure the TV is securely locked into position prior to closing the compartment door. Failure to do so can result in damage to the TV case and screen.

## **Stereo**

Your Dutch Star is equipped with an AM/FM dash stereo radio with CD player and auxiliary input jack for MP3 players. For complete operating details, please refer to the manufacturer’s literature that is provided in the literature bag for your unit.

## **Water Heater**



## **WARNING**

Do not light the water heater until it is filled with water. There is a switch on the exterior of the water heater labeled “Electric.” This switch must be in the “ON” position for the water heater to work in the electric mode.

Before lighting the water heater, fill the fresh water system. Purge any air from the water heater by opening all hot water faucets until water flows steadily from each one. The water heater installed in this coach may be a ten gallon gas/electric model with direct spark ignition. Optional is the ten gallon model with a direct spark ignition and engine assist feature. The water heater operates on both propane gas and 120 volt electricity.

It is important to read all of the safety information provided in the water heater manufacturer’s Operation Manual in the Owner’s Information Package. The following instructions are for the standard water heater with direct spark ignition (DSI). This appliance does not have a pilot light. It is equipped with an ignition device that automatically lights the burner. Do not try to light the burner by hand. Before lighting smell all around the appliance area for gas.

Be sure to smell next to the floor because some gas is heavier than air and will settle on the floor. Consult the Operation Manual for further instructions if a gas leak is noticed. The gas valve is fully automatic, no adjustments are necessary. Read the safety information provided in the Operation Manual before lighting the appliance. Turn off all of the electrical power to the water heater. Turn the gas supply to the “OFF” position. Wait five minutes for the gas to clear the area. If you smell gas, STOP! Follow the safety instructions in the Operations Manual. If gas odor is not noticed, then turn the gas supply to the “ON” position. Turn on the electrical supply to the water heater. Inside the coach there is a switch marked “WATER HEATER”. Turn the switch to the “ON” position. There will be a 15 second purge before the unit will spark. If the burner does not light on the first try, there will automatically be 2 more tries for ignition before it will lock out. Each ignition cycle will have a 15 second purge. If lock out occurs before the main burner lights, turn the switch to “OFF”, wait five seconds, and turn the switch to “ON” again. This will re-start the ignition cycle. The initial start-up of the water heater may require several ignition cycles before all of the air is purged from the gas lines.



## **WARNING**

Do not store any combustible materials or liquids near or adjacent to the water heater.

### **Water Heater Storage**

When storing your coach for the winter months, the water heater must be drained to prevent damage from freezing. The first step is to turn off all electrical power and propane gas going to the water heater. The water pump must also be turned off. Open both the hot and cold water faucets to drain the lines. After cooling, open the drain on the water heater. Drain the entire water system.

When preparing the coach for use after it has been stored, make certain the water system, including the water heater, has been filled before re-lighting the water heater. Failure to fill the water heater before lighting may damage the water heater and void the warranty.

### **Pressure Relief Valve**

The temperature and pressure relief valve is located on the exterior of the water heater. It is designed to open if the temperature of the water within the heater reaches 210° F, or if the water pressure in the heater reaches 150 pounds. Recreational vehicle water systems are closed systems, and during the water heating cycle the pressure build-up in the water system may reach 150 pounds. When this pressure is reached, the pressure relief valve will open and water will drip from the valve. This dripping will continue until the pressure is reduced to below 150 pounds, and the valve closes. This condition is normal and does not indicate a defective relief valve.

## **WARNING**

Do not plug the relief valve under any circumstances.

### **CB Radio/antenna (Optional)**

This radio can be used to communicate with other travelers on the road. The model installed is a remote type. The hand-held microphone/speaker contains the power, volume, and channel controls. Simply turn on using the power/volume control. Then select the channel you wish to monitor. Press the “Push-to-Talk-Switch” to transmit and release to receive. For more information regarding the operation of this CB radio, please consult the radio manufacturer’s Owner’s Manual.

### **Rear View Monitor System**

Installed as a standard feature, the rear view monitor system assists the driver in the backing and parking of the vehicle. This system consists of a camera mounted on the rear cap and a monitor located on the dash. With the MODE switch in the “MANU” position, the monitor will be on when the ignition is turned on. With the MODE Switch in the “AUTO” position, the monitor will display the picture from the camera when the vehicle transmission is placed in reverse (R). For detailed instructions on this and all procedures regarding the monitor system, refer to the monitor Operating Instructions in the Owner’s Information Package supplied with this coach.

### **Air Horns**

Air horns have been installed on this coach as a standard feature. These air horns are in addition to the horn installed on the chassis. A switch located on the dash allows you to choose either the chassis horn or the air horn. To operate either horn, press the center of the steering wheel.

### Freezer (if equipped)

The installation of a 100 pound freezer in an exterior storage compartment is an optional feature on this coach. This freezer operates on 12 volt and 120 volt electrical power. The freezer is on slides to move easily in for storage while traveling or out for pre-travel packing or campsite unloading.

For detailed instructions on the operation and maintenance of this freezer, please consult the freezer manufacturer's Owner's Manual in the Owner's Information Package provided with this coach.

### Icemaker (if equipped)

Depending on the floorplan of your unit, an icemaker may be an option. The icemaker operates on 120 volt electricity. For detailed information, consult the icemaker manufacturer's Owner's Manual in the Owner's Information Package provided with your new coach.

### Washer/Dryer (if equipped)

The plumbing and other preparations for the installation of a compact one-piece washer and dryer are standard features on this coach. To have the washer and dryer factory installed is an option. The washers and dryers used by Newmar function as those in a home, operating on 120 volt electricity. For more detailed information on the operating instructions, read the appliance Owner's Manual in the Owner's Information Package.

#### CAUTION

The gray tank valve must be in the "open" position when operating the washing machine.

### Carbon Monoxide Detector

Carbon monoxide is a colorless, tasteless, odorless gas. It is a by-product of the burning of fossil fuels (gasoline, propane gas, diesel fuel, etc.). The chassis and generator engines, furnaces, water heater, propane gas refrigerator, and range produce carbon monoxide constantly while they are operating. **Carbon monoxide is DEADLY.** Please read and understand the following precautions to protect yourself and others from the effects of carbon monoxide poisoning.



#### WARNING

Exhaust gases are deadly. Do not block the tailpipes or exhaust ports. Do not situate the vehicle in a place where the exhaust gases have any possibility of accumulating either outside, underneath, or inside your vehicle or any nearby vehicles. Outside air movements can carry exhaust gases inside the vehicle through windows or other openings remote from the exhaust outlet. Operate engines, carbon monoxide-producing systems, or components only when safe dispersion of exhaust gases can be assured. Monitor outside conditions to be sure that exhaust continues to be dispersed safely.

If you, or anyone else, experience any carbon monoxide symptoms (dizziness, nausea, vomiting, muscular twitching, throbbing in the temples, inability to think coherently, weakness and sleepiness, or intense headaches) exit the coach immediately. Seek medical attention if symptoms persist. Shut down the unit and do not operate it until it has been thoroughly inspected and repaired.

 **WARNING**

UNDER NO CIRCUMSTANCE SHOULD YOU OPERATE ANY ENGINE WHILE SLEEPING. When you are sleeping you will not be able to monitor outside conditions to assure that engine exhaust does not enter into the coach. Check the exhaust system frequently for damage. If damage is found, do not operate the system. Never modify the exhaust system(s) in any way.

The detector is equipped with a “sensor activation strip.” This strip must be removed for the detector to operate properly. This should have been done during the dealer’s Pre-Delivery Inspection. Please check the detector to verify that the activation strip has been removed. Please consult your carbon monoxide detector User’s Guide for more detailed information.

## CABINETS, FURNITURE & INTERIOR FEATURES

### CABINETS

The cabinetry in your RV is constructed on-site at the Newmar Production Facility. Hardwood raised panel doors are standard throughout the unit. The standard cabinets in your unit are finished in vinyl veneer. Your unit may be equipped with the optional hardwood cabinetry in a variety of finishes. Your cabinetry was designed with function and convenience in mind, and was built to exacting standards by modern craftsmen.

Storage is an important factor to all RV owners. Keeping this in mind, the cabinetry is structured to provide as much storage as possible. Your unit may include features such as adjustable pull out pantry boxes in the kitchen. In the bedroom, the bed platform lifts to provide an additional, convenient storage area. Once the bed platform is lifted, it is held open by pressurized struts to allow hands-free access.

A countertop with a color coordinated edge is installed in the kitchen. To clean, wipe with a damp cloth and for “dried on” spots or rings, wipe with a damp cloth and a mild liquid soap. Strong chemicals and solvents may damage the surface and should be wiped up immediately, then rinse the surface with water.

Avoid cutting directly on the countertop surface, avoid excessive heat, and keep harmful chemicals away to avoid countertop surface damage.

Metal drawer guides are installed on the drawers in your unit. These guides provide a smooth opening and closing of the drawers. To open a drawer, lift up slightly and pull open. The way this mechanism works will prevent the drawers from unintended opening while traveling.

All of the cabinetry can be easily cleaned with any commercial furniture cleaner or polish. As with any wood product, do not saturate these cabinets with water or any other liquid. Be sure to wipe up spills as they occur to avoid staining.

### FURNITURE

#### Living Room/Kitchen Area

A standard feature in the kitchen area is the built in booth dinette with drawers under the seating areas. The dinette provides added storage under the seat area of the booth, along with an extra sleeping area. The sleeping area is made by lowering the table top and arranging the cushions.

In the living room you will find a sofa. Depending on the floorplan of your unit and the other furniture in your living area, a Hide-A-Bed or a Magic Bed sofa are optional. If you have any questions, contact the sofa manufacturer.

In the living room, you may also find a swivel/rocker recliner. Many other furniture options are available such as a free standing leather/vinyl recliner, a leather/vinyl push back recliner with an ottoman, a leather/vinyl swivel rocker recliner, a leather/vinyl L-lounge, or a folding coffee table.

In this unit, the front seats feature a six-way powered base that will move the chairs forward and backward, as well as up, down, forward and reverse tilt. The seats also have a three-point seat belt and swivel and recline features. When the unit is not in motion, they can be swiveled to face the living room of the unit. To turn the chairs, first extend the slide out room.

Then move the chairs backwards all of the way to provide enough clearance for the steering wheel. Once this is done, the chairs will swivel without interference. The control switch is located on the left-hand side in front of the power base controls. Pushing the switch forward will inflate the support while pushing back will deflate it. An oversized passenger seat equipped with a power footrest may be optioned in.

### **Bedroom Area**

A decor coordinating quilted bedspread with a reverse sham and an accent pillow may be included as part of this unit's standard bedroom package. For best results, it is recommended that the bedspread be DRY CLEANED ONLY. As an option, a pillow top mattress or a king size mattress may be installed in lieu of the standard mattress, depending on the floorplan of your coach.

## **INTERIOR FEATURES**

### **Flooring**

The floor covering throughout the living room and bedroom of the unit is nylon tufted cut loop carpeting. In the Owner's Information Package you will find literature supplied by the carpet manufacturer. This information will be helpful in maintaining and extending the life of the carpet. Please refer to this information for the carpet or hard surface flooring care and cleaning instructions. Simple vacuuming is all that is necessary to remove loose dirt and debris for everyday cleaning. Abrasive cleansers and scouring pads can scratch and damage the surface also.

### **Ceiling**

The ceiling in this unit is covered with a padded vinyl ceiling headliner. The recommended cleaning instructions are to use a soft cloth and a mild detergent.

### **Window Treatment**

The window treatments are roller window shades and lambrequins.

## ELECTRICAL FEATURES

### ELECTRICAL SYSTEMS

#### General Information

There are two electrical systems in your coach. They are the 12 volt DC system and the 120 volt AC system. Most standard appliances require 120 volt electricity while the majority of the lighting used in recreation vehicles is powered by 12 volt electricity. The power for the 12 volt system is supplied by the coach batteries, which are charged by the inverter. The power for the 120 volt systems is supplied by the power cord when the unit is connected to an outside power source or by the generator. The inverter can also supply 120 volt power. It will transform 12 volt electricity from the batteries into 120 volt power for basic appliances.



#### CAUTION

Failure to turn off the 120 volt appliances when starting or stopping the generator may damage the transfer switch and/or electrical appliances.



#### WARNING

##### Use of “Adapter” cords with the RV shore power cord.

All Newmar units are manufactured with either a 30 or 50 amp electrical breaker box and electrical system. A unit with a shore power cord that has 3 prongs on it has 30 amp service; if the shore power cord has 4 prongs, it has 50 amp service. To provide the correct amperage into the RV and to assure the operation is as designed, it is important that they be plugged into the correct type of properly grounded receptacle. The receptacle **MUST** be properly grounded to insure safe, proper operation of all electrical components.

**NEWMAR CORPORATION DOES NOT RECOMMEND USE OF “ADAPTER”, “CHEATER”, OR “DOG BONE” STYLE CONNECTORS THAT WILL MODIFY THE EXISTING SHORE POWER CORD TO A DIFFERENT STYLE OF OUTLET. USE OF THIS TYPE OF ADAPTER WILL GREATLY REDUCE THE AMOUNT OF AVAILABLE CURRENT IN THE UNIT, AS WELL AS CREATES THE POTENTIAL FOR ELECTRICAL FAILURE AND/OR FIRE. NEWMAR CORPORATION CANNOT ASSUME LIABILITY FOR FAILURES OCCURRING TO THE RV, ITS ELECTRICAL SYSTEM, OR ANY OF ITS COMPONENTS FROM THE USE OF ANY ELECTRICAL ADAPTER.**

To connect the unit to 120 volt shore power, first make sure all of the breakers are in the off position. This is done to avoid a power surge. Unwind the power cord from the electrical compartment. The standard electrical service in this unit is 50 amps with a flexible cord. Check to make sure the pins in the outlet are oriented correctly, that they match the power cable, and that they are in good condition. If there is a circuit breaker switch at the plug, it should be turned OFF before making the connection. Insert the plug completely into the outlet and turn the circuit breaker on. Close and lock the electrical compartment door to keep the contents clean, dry, and secure. Close the cover on the power box, if equipped, to avoid an unintended disconnection and to keep contents clean. Switch the main breaker to the ON position. The 120 volt system will energize all 120 volt circuits and outlets when the main breaker is turned on.

## Breaker Boxes

The 120 volt and 12 volt breaker boxes are generally located in the overhead cabinet on the rear bedroom wall. Circuit breakers and fuses are installed to protect the electrical system from overloading. Do not attempt to change the circuitry or add appliances yourself. Please consult an authorized Newmar Service Center.

## Batteries

The chassis batteries on your motorhome are installed and warranted by the chassis manufacturer. The house batteries on your motorhome are installed by Newmar Corporation, but warranted by the battery manufacturer. These batteries are used to operate the 12 volt items that are not a direct part of the chassis. They are located on a pull out tray in an outside compartment.

### CAUTION

Do not use the motorhome with the coach batteries disconnected.

The coach and chassis batteries are recharged by the vehicle's electrical system whenever the engine is running. A decline in the coach battery voltage may be noticed while the chassis batteries are being charged. The inverter/converter will automatically charge the coach batteries when the unit is connected to a 120 volt outside power source. The chassis batteries are isolated from the coach batteries. This prevents the chassis batteries from being drained by the interior 12 volt equipment, allowing ample voltage for engine ignition.

## Battery Boost Switch

The battery boost switch is located on the dash. This switch briefly connects the coach batteries to the chassis batteries. This allows the chassis batteries to borrow power from the coach batteries to assist in starting the engine. If the chassis batteries cannot turn the engine over in the normal mode, hold down the battery boost switch and attempt ignition. By using the battery boost switch while trying to start the chassis engine, a jump start situation is created between the coach and chassis batteries. If the battery boost switch is required to start the engine on a regular basis, ask your dealer to check the chassis batteries and charging system.

## Battery Inspection & Care

### WARNING

Remove rings, metal watch bands, and other metal jewelry before working around batteries. Use caution when using metal tools. If a tool contacts a battery terminal or metal connected to it, a short circuit could occur which could cause personal injury, explosion or fire.

### CAUTION

Disconnect the 120 volt electrical power cord and the negative terminal from the coach batteries before working on the electrical system.

Remember that when batteries are not used for an extended period of time, they may lose their charge. Periodic charging of the batteries during storage of the unit will increase the life of the battery. Check the external condition of the battery periodically. Look for cracks in the cover and case. Check the vent plugs and replace them if they are cracked or broken. Keep the battery clean. Accumulations of acid film and dirt may permit current flow between the terminals, which could drain the battery.

To clean, wash the batteries with a diluted solution of baking soda and water to neutralize any acid present. Rinse thoroughly with clean water. Foaming around the terminals or on top of the battery is a sign that acid is being neutralized. Avoid getting the baking soda solution in the battery. Secure all vent caps. Dry the battery cables and terminals to prevent corrosion. Do not use grease on the bare metal inside the cable terminals. Grease can act as an insulator, and electricity will not flow through it. A plastic ignition spray will protect the terminals after they have been cleaned.

## **WARNING**

Do not allow the battery fluid to contact your skin, eyes, fabric, or painted surfaces. The fluid could cause serious personal injury or property damage. Wear eye protection when working with any battery.

The batteries should be removed and stored in a warm place when not using your motorhome for an extended period of time. Mark the cables, positive and negative, for easy identification. Batteries are not to be stored on concrete floors. The batteries require periodic charging during storage. If the motorhome is to be stored for a long period of time, it is recommended that all of the batteries inside the unit be removed from clocks, radios, smoke alarms, etc. This will prevent unnecessary drain and corrosion of the batteries. The coach batteries are 6 volt RV/Marine deep cycle batteries. This type of battery consumes water and must be filled periodically. Please be sure to check the battery water level on a regular basis. Consult the Owner's Manual supplied by the battery manufacturer. This can be found in the Owner's Information Package received with this unit.

### **Battery Disconnect Panel**

The battery disconnect panel for house batteries is located above or near the entrance door. There are two switches on the panel. The top switch is used to measure the battery voltage. The lower switch is used to disconnect the battery when the unit is stored for any period of time. Pressing downward disconnects the coach batteries, not the chassis batteries. This is done to prevent the coach batteries from being drained during storage. It disconnects all of the 12 volt circuitry from the batteries, with the exception of the LP detector. When taking the unit out of storage, press upward to re-connect the batteries. This will make the 12 volt system ready for use.

Depending on the chassis of the coach, diesel pusher motorhomes may be equipped with a second disconnect switch strictly for the chassis batteries. If equipped, this "Master Kill Switch" may be located in the rear engine compartment. This switch disconnects all power to the coach so that it cannot be started. It is used to prevent accidental ignition when the engine is being serviced.

### **12 Volt Receptacles**

Your unit may be equipped with two 12 volt receptacles conveniently located in the dash area. These 12 volt receptacles can be used for items such as cellular phones or personal computers. As an option, an extra 12 volt interior receptacle may be added to your coach.

### **120 Volt Receptacles**

For your convenience, there are 120 volt receptacles located throughout the interior of the unit. As an option, an extra receptacle may be added. These receptacles require three-pin plugs that provide proper grounding to protect you from electrical shock.

Do not use an adapter, cheater, or extension cord that breaks the continuity of the ground circuit to the ground pin. Never remove the ground pin from a plug in order to connect it to a two-pronged ungrounded outlet. Never operate the camping vehicle with an electrical short.



An electrical short may cause the exterior of the unit to shock you when touched. If you feel even the slightest shock, disconnect the unit from the 120 volt power source. It is usually a break in the grounding circuit. The grounding circuit must be continuous from the frame to the distribution panel, to the power cord, and to the earth ground.

### **Ground Fault Circuit Interrupt Receptacles**

The 120 volt electrical outlets in the kitchen and bath area are ground fault circuit interrupt (GFCI) protected receptacles. The electrical outlets located in the slide out are wired through the kitchen GFCI. The exterior electrical outlets are wired through the bathroom GFCI. If an item plugged into a slide out or outside receptacle is not working, check for a tripped GFCI in the kitchen or bathroom. These outlets protect the user from ground faults between a hot wire and ground. The GFCI will not reduce the shock hazard if the short is between a neutral and hot wire, or two hot load wires.

The GFCI should be tested at least once a month. The 120 volt electrical system must be on in order to test the GFCI. The reset button needs to be pushed in all of the way before starting the test. Push the test button. This will cause the reset button to pop out which means that the protected circuits have been disconnected. Push the reset button back in until a click is heard. This will reactivate the protected circuit. If the GFCI is working properly the reset button will remain in the “IN” position.

### **ICC Flasher**

On the dash you may have a switch labeled “ICC Flasher.” This switch is a momentary type of switch. This means it is only active while the switch is being pressed. It enables the driver to communicate with other traffic by flashing the clearance and side lights of the coach. If the lights are on, it will turn them off. If the lights are off, it will turn them on.

### **Inverter/Converter**

When 120 volt power is not available, either from the power cord or the generator, the inverter/converter may be used, if installed. The control panel for the inverter is located above or near the entrance door. Once turned on, the inverter transforms 12 volt power to 120 volt power for the operation of lights, appliances, televisions, etc. The 120 volt power that is generated from the inverter is routed to the electrical sub-panel located next to the main breaker box in cabinet above the bed.

The breakers in the sub-panel are labeled to explain where the 120 volt power is routed. It generally supplies power to the microwave, kitchen, bath, and selected receptacles. The inverter is equipped with an automatic transfer switch. This allows automatic switching from inverter to converter. When you are connected to an outside power source or running the generator, the converter (in the inverter) will automatically switch on to charge the 12 volt batteries. For more detailed information consult the manufacturer Owner’s Manual located in the Owner’s Information Package.

### **Generator**

The generator is located in a compartment in front of the motorhome. It is mounted on slides for easy access. The slides for the generator must be unlocked before free movement is allowed. Prior to starting or stopping the generator, make sure all of the 120 volt appliances are turned off. After the generator has started, wait until the transfer switch has connected before turning on any of the appliances. The generator can be started from either the remote start switch located on the dash or directly at the generator itself. The hour meter installed on the generator calculates the number of running hours of the generator motor. This is used for maintenance schedules.

If your coach contains an Energy Management System, 8kw generator, and three roof air conditioners, the combined load may exceed the capabilities of the generator. Please remember to turn off one of the air conditioners as the 8kw generator is not intended to run all three roof air conditioners at the same time.

**CAUTION**

Failure to turn off the 120 volt appliances when starting or stopping the generator may damage the transfer switch and/or electrical appliances.

Consult the manufacturer Owner’s Manual for detailed operating instructions.

**Automatic Transfer Switch**

Your unit is equipped with an automatic transfer switch. When the generator is turned on, this switch automatically transfers from shore power to generator power. There will be a slight delay between the start of the generator and the electrical connection. This delay allows the generator to reach normal operating speed without needing to supply a required load. When the unit is plugged into the outside power source, a click will be heard in the transfer switch box. The sound is normal and indicates that the unit is changing over to the outside power source.

**Wiring Connector**

Standard on your motorhome is a Class Five, 10,000 pound car towing hitch. This allows the consumer the capability of towing their passenger car while traveling. Also installed with the hitch is the wiring pigtail to connect tail lights, brake lights, turn lights, etc. of the towed vehicle with that of the motorhome. The pigtail used is the standard seven-pin connector. The color scheme for the pigtail is as follows:

- Stop & Left Turn Signal..... Red
- Ground..... White
- Stop & Right Turn Signal...Brown
- Clearance & Tail Lights.....Green
- Aux. Tow Connector Prep...Black
- Back-up Lights.....Yellow
- Brakes.....Blue

This view is looking into the tow vehicle

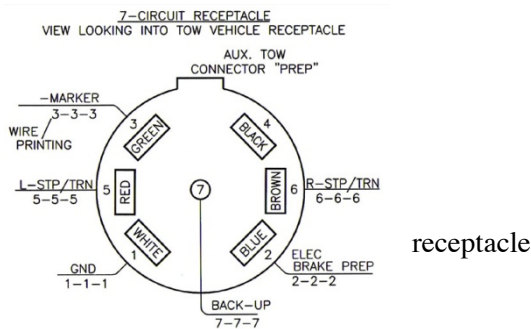



## EXTERIOR FEATURES

### EXTERIOR FEATURES

#### Exterior Sides

The sides of this unit are constructed of gel-coated fiberglass. To add to this feature, the end caps are also gel-coated fiberglass. Clean the fiberglass material with a mild cleanser and warm water. Use only soft cloths. Using stiff bristle brushes may cause scratches in the fiberglass surface. Please note: Newmar is not responsible for weathering/oxidation of gel-coated surfaces.

Lighted storage compartments are located on the exterior sides of your unit. These compartments provide additional space for your belongings while you are traveling.

#### Security Lights

These lights help to light the side of the unit for added protection.

#### Head Lamps

Your new RV is equipped with headlamps that are not sealed. This design features a replaceable bulb assembly and a vent system. As these headlamps are not sealed, they may exhibit, due to condensation, a fine mist or white fog to small droplets of water on the inside of the lamp lens.

Condensation occurs when the air inside the lamp assembly, through atmospheric changes reaches the ‘dew point’. When this takes place, the moisture in the air within the lamp assembly condenses, creating a fine mist or white fog on the inside surface of the lamp lens or chrome reflector surfaces.

Most headlamps are designed to remove any accumulated moisture vapor by expelling it through a vent system. The vent system operates at all times however; it is most effective when the lamps are “ON” and when the vehicle is in motion.

#### Roof

This unit is manufactured with a 7mm decking material. Proper care and routine maintenance of your roof is necessary for trouble-free performance. See chapter 14 for cleaning instructions. A ladder is installed on your coach to assist you in gaining access to the roof for the sole purpose of routine inspections and maintenance.

#### Leveling Jacks

##### **WARNING**

It is recommended that the leveling and stabilizing procedure is completed before operating any room extension. Note: The slide out can be operated without utilizing the leveling system, but it is recommended to have the unit as level as possible.

This unit is equipped with leveling jacks. The jacks work in pairs: front, right side, left side, and rear. Before extending, the engine must be off, the ignition switch must be in the “ACC” position, and the transmission must be in park. The parking brake needs to be set and the tires blocked securely.



## IMPORTANT

If the hand/auto park brake is not set, the “NOT IN PARK/BRAKE” light will come on when the “ON” button is pushed. The panel will turn on, but the system will not operate.

### “Hydraulic” Leveling

The hydraulic portion of the leveling system uses four hydraulic jacks to level the unit. Because the weight of the unit is on the jacks, and they are in physical contact with the ground, the unit is much more stable and does not shake or move when walking inside it. Additionally, the hydraulic system has a greater range of leveling, allowing it to provide greater leveling capability should you encounter camp sites with substantial slope.

1. Make sure the motorhome is securely parked, and the set the parking brake.
2. With the ignition key in the “ACC” position, press the “LEVEL” button. The light will come on and glow steadily.
3. Once you are certain the leveling area beneath the unit is clear of obstructions, press the “LEVEL” button a second time to begin the automatic hydraulic leveling process. The light will begin flashing and the leveling cycle will begin. The system will dump the air out of the air bags and deploy the jacks to level the unit.
4. To retract the jacks, start the engine and press the “STORE” button. Allow the system to completely raise the jacks and turn itself off.



## CAUTION

Do not lift the wheels off the ground when leveling. The unit can roll forward or backward when tires are lifted off the ground. If the “Excess Slope” light is on, the system is sensing that the site is too sloped to allow the leveling jacks to bring the unit to a comfortable state of level. Great care must be taken when trying to level in a sloped site to make sure a tire (or tires) is not lifted off the ground. Also, the leveling jacks and support system should be cycled once a month or whenever the vehicle is used to keep the system in operating condition.



## IMPORTANT

It is important to allow the HWH leveling system to run the complete cycle and turn itself off when operating in the “store” mode. The system will completely retract the jacks and turn itself off. If the system is turned off prior to the automatic shut off, there is the potential that the jacks have not fully retracted. Also, be sure to visually inspect the jacks prior to departure to insure that they have fully retracted and the underside of your unit is ready for travel.



## IMPORTANT

The leveling system should be cycled once a month or whenever the vehicle is used to keep the system in operating condition.

To retract the jacks, turn the ignition switch “ON” but do NOT start the engine. Press the “ON” button on the control panel one time. The “ON” indicator light will glow steady. Press the “STORE” button. As each jack retracts, its red “WARNING” light will go out. The vehicle can be moved as soon as the red “WARNING” lights are out, provided the jacks are in the STORE/TRAVEL position. The system will automatically shut down approximately two minutes after the four individual red “WARNING” lights are out. Refer to the HWH Owner’s Manual for more instructions. The engine can be started once the jacks have fully retracted.



## WARNING

NEVER attempt to move the unit with the leveling jacks deployed. Always visually inspect the jacks prior to moving to insure they have fully retracted and are in the stored position, and the system is "OFF".

## CAUTION

Do not lift the wheels off the ground when leveling. The unit can roll forward or backward when supported only by the jacks.

## IMPORTANT

If the hand/auto park brake is not set, the "NOT IN PARK/BRAKE" light will come on when the "ON" button is pushed. The panel will turn on, but the system will not operate.

### Electric Steps

This unit is equipped with electric entrance door steps. The switch to operate these steps may be located in an overhead cabinet above the entrance door. When the power switch for the steps is in the on position, simply open the door and the steps will open. Detailed operation for the electrical entrance door steps is as follows:

1. Turn the step power switch on.
2. Close the door. The step should retract and lock into the up position.
3. Open the door. The step should extend and lock into the down position.
4. Turn the step power switch off. The step should remain in the extended position when the door is closed. Turning off the power with the step retracted will hold the step in a retracted position as well.
5. With the step extended, turn the step power switch off and close the entrance door. Turn the vehicle ignition on. The ignition override system will go into effect, and the step will automatically retract.
6. Turn the vehicle ignition off and open the door. The step will extend and lock in the down position.

## CAUTION

If the door is opened and closed without allowing the step to fully extend and lock in the 'DOWN' position, the step will retract and lock in the 'UP' position. When the door is reopened, the step will not extend. The power switch must be turned on for the step to extend. This feature is only operative the first time that door is opened after the vehicle ignition is turned off. When the ignition is on, the step will always activate with the door movement, regardless of the step power switch position. If the vehicle is driven with the step in the extended position, there is the possibility of causing major damage to both the step and the vehicle.

### Mirrors

This vehicle is equipped with convex remote controlled defrosting exterior rear view mirrors. Always adjust the mirrors for maximum rear visibility prior to driving. Make sure the seat is positioned for proper vehicle control.

The side exterior mirrors are adjusted by using the multiple directional switches located on the driver's door. Select the mirror to be adjusted by pointing the arrow in the direction of that mirror. Move the control in the direction of movement desired to obtain the best view. The adjustment control moves the top half of both mirrors.

The bottom half of the mirror is convex and is adjusted manually. These mirrors also contain heating elements to defog or de-ice the mirror glass during cold weather operation. The



ON/OFF switch for this feature is located by the adjustment control. The convex exterior chrome mirrors with remote control and defrost are optional on this unit.

## **IMPORTANT**

Objects viewed in convex mirrors appear smaller and farther away than they actually are.

### **Windows**

The windows installed in this unit may be the radius torque style double pane tinted safety glass. These windows are also referred to as jalousie windows. They open with the simple turn of a crank. A power window is available on the driver's side as an option.

In the bedroom of the unit, one window will be marked "EXIT." This window is an emergency escape, or egress, window. To open in case of an emergency, lift the red handles at the bottom of the window and push out.

### **Vents**

A 12 volt vent may be installed in the kitchen. An optional vent may be installed. If installed, this vent is equipped with a rain sensor on the roof hood. Anytime the vent is open and it senses rain, it will automatically close. The vent is controlled by the wall thermostat. Once powered "ON" and the desired temperature is selected, the vent will run until the temperature is reached. When the temperature is reached, the vent will automatically shut off.

Do not leave the fan in active mode while the unit is in storage or unattended for long periods of time. High winds or other unusual conditions or obstructions may prevent the vent from closing resulting in leakage, which could cause serious damage.

The vent installed in the bathroom is also powered by 12 volt electricity. This vent is controlled by the ON/OFF switch located on the wall. A vent similar to the one installed in the kitchen is optional.

In the bath area a skylight is also installed above the tub/shower.

### **Doors**

The front entrance door is a radius door equipped with a dead bolt lock for added security and a power flush step well cover. When the door is opened fully, the door hinge will automatically hold the door open. To close the door from the open position, either the inside or outside handle must be released for the door to move. For your safety, a lighted, acrylic assist handle has been installed at the entrance door of the unit.

## Awnings



### **IMPORTANT**

It is important prior to extending your main awnings that you inspect the areas beside and around your unit where the awning will extend to insure proper clearance.

### Side Awning

Extension and retraction is controlled by a switch located adjacent to the entry door, either on the wall or in a side overhead cabinet. To operate, follow these instructions:

### Entry Door Awning

The entry door awning is a power operated awning. To extend the awning, press the “Extend” button on the switch plate. To retract it, press the “Retract” button.

### Window Awnings

The window awnings are operated as all the power awnings on your unit. Use the appropriate switches to extend or retract the awnings as desired, and always check for clearance on the exterior of the unit to be certain nothing will interfere with their deployment.





## PLUMBING & BATH FEATURES

### FRESH WATER SYSTEM

#### Monitor Panel

The monitor panel allows you to check the approximate levels in the fresh, gray, and black water holding tanks, as well as the battery condition. The monitor panel is generally located above or near the entrance door. Simply press the button of the item to check its status. The empty indicator light will always light when the button is pressed. If the tank is full, all of the lights will be on. Lights are sequential and indicate the level in approximately 1/4 tank increments. For example: If the tank selected is approximately 1/2-full, then the indicator lights E, 1/4, and 1/2 will be lit. On the right hand side of the monitor panel is the water pump switch. This switch controls the power going to the water pump, turning it either on or off.

#### Monitor Panel Calibration

The monitor panel comes to you factory calibrated for accuracy and should not need to be adjusted. In the event that the system does not read accurately, then re-calibration may be necessary. The procedure for re-calibration is simple: First, fill the tank to be re-calibrated. Second, using the adjustment tool enclosed in the Owner's Information Package (or any small flat-bladed screw driver), simultaneously push the button for that tank and rotate the adjustment screw located above the button and behind the face plate counter-clockwise until some of the lights turn off in sequence. Then slowly rotate the adjustment screw clockwise until the full light is completely on. Repeat this procedure as necessary for the remaining tanks. The system is now calibrated properly.

#### Water Pump

The water pump is self-priming and totally automatic, operating on demand whenever water is required. The water pump is used to pressurize the fresh water system when the unit is not connected to city water. The switches to this pump may be located in the bathroom above the entrance door and in the water works compartment. To start the pump, follow these instructions:

1. Fill or partially fill the fresh water supply tank.
2. Open the kitchen and bathroom faucets.
3. Turn the water pump switch on and allow the water to fill the water line and the hot water heater.
4. Close each faucet after it delivers a steady stream of water (close the cold water first). Leave the hot water faucets on until they also deliver a steady stream of water. This will ensure that the water heater is filled with water.
5. The water pump should stop running once all faucets are closed.
6. The pump is now ready for automatic operation. The pump will run when a faucet is opened and stop when a faucet is closed.
7. Never allow the pump to run for long periods of time without water in the supply tank. Pump damage or blown fuses may result.

If water doesn't flow when a faucet is turned on while using the demand system, use the following trouble shooting chart:

<b>SITUATION</b>	<b>SOLUTION</b>
<b>Pump running — no water</b>	<b>1. Fill tank. 2. Clear the water line to the pump.</b>
<b>Pump doesn't run</b>	<b>1. Check the pump switch. 2. Check the 12 volt fuses. 3. Check the electrical connections. 4. Check the battery.</b>

All of the water should be drained from the fresh water system when the unit is not in use for more than one week. For more detailed information regarding the water pump, refer to the water pump manufacturer's brochure in your Owner's Information Package.

### City Water Hook-Up

When connecting your unit to city water, be certain to use a water hose manufactured and labeled for potable water. This will ensure that the hose will not alter the taste of the water. To hook the city water supply to the unit, connect one end of the hose to the city water supply. This will usually be a faucet or valve similar to your garden hose valve at home.

Turn the city water supply on for a few seconds in order to clear the line. Once the hose has been flushed, turn the supply off. Connect the other end of the hose to the city water connections. Turn on the water supply and open all of the faucets to clear the air from the lines in the unit. Once air pockets have been purged from the water lines and water flows freely, close all of the faucets. The city water supply is under pressure; therefore the water pump is not necessary when connected to city water. Once the city water fill valve is opened, water is supplied to the fresh water system including the hot water heater, faucets, and stool. To disconnect from the city water supply, close the valve and remove the hose from the city water supply. Disconnect the hose from the city water connection and store the hose in the water compartment.

### Fresh Water Tank Fill

The fresh water tank is filled from the city water hook-up. The valve located in the service compartment near the water hook-up determines whether the city water is going through the water system or into the fresh water tank. An additional way to fill the fresh water tank is with the winterizing intake hose placed in a bucket of water (See Chapter 9). Since there is not an automatic shut-off for the fresh water tank fill, check the level from the monitor panel while filling the unit. The excess water will be vented from an overflow vent pipe onto the ground when the tank capacity has been reached. This pipe is installed in the fresh water tank to prevent tank rupture from overflowing. All of the water should be drained from the fresh water system when the unit is not in use for more than one week. Whenever possible, drain the fresh water tank before traveling. Water in the tank will reduce the carrying capacity of the unit.

## Sanitizing

To assure complete disinfecting of your fresh water system, it is recommended that the following procedure be followed on a new system, on one that has not been used for a length of time, or one that may have become contaminated. This procedure is also recommended before long periods of storage, such as over the winter months:

1. Drain the fresh water tank by opening the drain valves. There is one valve per water tank. All of the faucets should be in the closed or off position.
2. Prepare a chlorine solution using one gallon of water and 1/4 cup of chlorine bleach (5% sodium hypochlorite solution). Prepare enough of the chlorine solution to administer one gallon of solution for every 15 gallons of tank capacity. For sanitizing this unit, prepare 4-1/2 gallons of the chlorine solution. This mixture puts a 50 PPM (parts per million) residual chlorine concentration in the water system that will act as a quick kill dosage for harmful bacteria, viruses and slime forming organisms. Concentrations higher than 50 PPM may damage the water lines and/or tank.
3. Once the fresh water tank is empty, close the drain valves on the water tank.
4. Pump the chlorine solution into the tank. This is done by placing the winterizing hose into the chlorine solution. Close the valve from the fresh water tank to the pump and open the valve from the solution to the pump. Turn the tank fill valve from city water to tank fill. Turn on the water pump until all of the solution is pumped into the fresh water tank.
5. Turn off the water pump. Close the valve to the solution. Open the valve from the tank to the water pump. Fill the water tank with the city water tank fill (or by using the same method as was used to put the sanitizing solution into the tank). Remove the water filter (from the drink dispenser faucet, if installed) and install the by-pass pipe to allow the sanitizing solution access to the faucet. Open each faucet in turn including the kitchen faucet, bath faucet, inside and outside shower, turning on both the hot and cold, and flushing the stool until all of the air has been purged from the pipes and the water runs freely. The entire system will then be filled with the sanitizing solution.
6. Allow the 50 PPM disinfecting solution to stand in the system at least four hours.
7. Drain the system and flush with fresh water. The water system needs to be flushed with clean water repeatedly, if necessary, until there is no chlorine taste or smell left in the system. To remove any excessive chlorine taste or odor that might remain, prepare a solution of one quart vinegar to five gallons of water. Allow this solution to agitate in the tank for several days by vehicle motion. Drain the solution and refill the tank with clean water.

## Water Filtration System

Your unit is equipped with a fresh water filtration system. This system uses extruded carbon filter cartridges to remove sediment and certain impurities from the incoming water supply. The filter assembly is located in the basement water compartment.

To replace the filter cartridge, turn off the water supply to the RV (at the city water connection). Unscrew the filter canister by rotating it clockwise. Replacement filter cartridges are available through your Authorized Newmar Dealer; have them order part number 03738.

Insert the new filter cartridge, positioning it so the opening in the bottom of the filter seats on the molded ring at the bottom of the canister. Reattach the canister to the filter housing by rotating the canister in a counter clockwise direction.



When replacing the filter, make certain the rubber “O-Ring” seal is properly positioned in its groove in the cartridge housing. An improperly seated or missing seal will cause leakage around the perimeter of the filter housing. Use caution not to over tighten the canister when attaching it back to the housing.

### **Water Heater By-Pass System**

The water heater by-pass valve is located in an outside compartment near the water heater. By closing the water heater supply valve and opening the by-pass valve you can divert water away from the water heater. This is done when winterizing your unit. Using the by-pass will keep antifreeze out of the water heater when winterizing the system. Draining the water heater during winterizing is a **MUST**.

### **Fresh Water Lines**

Vibration and flexing during traveling can cause pipes and fittings to work loose. Check all of the plumbing connections for leaks on a yearly basis. If the water pump runs when all faucets are turned off, check for a leak. Be sure the drain valves are closed. Connections at the kitchen and bathroom faucets normally seal with hand tightening and a half turn with a wrench. If a fitting leak persists, disconnect it completely and check for mineral deposits or foreign material on the sealing surfaces. Clean the surfaces thoroughly and reinstall the fitting. Take the coach to an authorized service center for repairs if the system continues to leak. Follow the winterizing instructions given in Chapter 9 to reduce the risk of leaks caused by cracks from freezing pipes. Freezing damage can be extensive and expensive.

### **Exterior Shower**

A feature on your coach is the exterior shower. The exterior shower is located on the off door-side of the coach. The exterior shower feature allows you to do such things as rinse off sand or grass, muddy shoes, or bathe your pet outside of your unit. The faucet operates just as it would in your kitchen or bathroom.

## **WASTE WATER SYSTEM**

### **General Information**

The waste drainage system was designed to provide adequate and safe storage and/or disposal of waste materials. All of the materials used in the making of this system are tested by a nationally recognized testing laboratory. The drainage system uses plastic piping and fittings connected to the sinks, toilet, and holding tanks. This provides for their drainage to an outside termination. The unit should be reasonably level for best operation of the system. There are two separate waste systems. The gray water system is for waste water from the sinks and shower. The black water system is generally for sewage waste from the stool. Each tank has its own control valve, and both tanks drain through the sewer drain hose.

### **Toilet**

The standard toilet in your unit is a china stool. The toilet operates with water from either the fresh water tank with the water pump on or the city water supply. Before using the stool, add water to the bottom of the tank. Refer to the “BLACK WATER TANK” instructions in this chapter. The stool flushes waste directly into the black water holding tank. The stool uses high velocity water injection to produce a swirl effect in the bowl. The greatest problem that causes stool solids to build up in the holding tank is lack of liquids. When using your stool, it is wise to fill the stool 3/4 full of water. This will help to wash the solids away from directly below the stool and to ensure complete dumping of the holding tank. To add water to the stool bowl, lift or raise the flush lever until the desired water level is reached. To flush the stool, push down on the lever until the water swirls. A small amount of water should remain in the bowl.

The stool should be cleaned regularly for maximum sanitation and operational efficiency. Clean the toilet bowl with a mild bathroom cleaner. Do not use chlorine or caustic chemicals, such as laundry bleach or drain opening types, as they will damage the seals in the toilet and dump valves.

Refer to the toilet manufacturer's Owner's Manual in your Owner's Information Package for complete instructions and a troubleshooting guide.

## P-Traps

Each of the sink drains, the shower drain, and the washing machine drain (if equipped) has a water trap (P-Trap) to prevent holding tank odors from entering the coach. These traps must have water in them in order to trap the odors. While traveling, the water may splash out of the sink and shower drains. While stored, the water may evaporate allowing an odor to enter the coach. If this occurs, run water from the faucet into the drain, allowing water to fill the trap.

## Black Water Holding Tank

The black water, or sewage, holding tank is located directly beneath the toilet. Before using the stool, you will need to treat the tank with water that is mixed with an odor controlling chemical. These chemicals are readily available at any RV supply store. Be careful not to spill the chemical on your hands, clothing, or the carpet because it may cause a permanent stain. Pull the toilet levers forward to allow the chemical to mix with the toilet water. Continue pulling the toilet levers until at least one inch of solution is directly under the toilet. Release the levers, and the waste tank is ready for use.



## CAUTION

Use only approved RV odor controlling chemicals in the holding tanks. Products containing ammonia and petroleum will damage the ABS plastic holding tanks and seals.

## Gray Water Holding Tank

The gray water holding tank is located in the underbelly of the unit. It is primarily used for the drainage from the kitchen and bath sinks and the shower.

## Waste Water Disposal

Both of the holding tanks terminate in a valve arrangement that permits draining each tank separately or together. It is recommended to drain the black water tank before the gray water tank. This will allow the water from the gray tank to wash the black water residue from the drain lines and hose. The valves that open to release the water are called gate valves. The blade that closed the opening in the sewer drain pipes is connected to the T-handle to release the contents of the tank(s) when pulled. The sewer line must be securely capped during self-containment use to prevent leakage of waste material onto the ground or pavement. Do not pull the holding tank gate valve open when the protective cap is installed on the pipe. Always drain the tank into an acceptable sewer inlet or dump station.

## **WARNING**

Holding tanks are an enclosed sewer system and must be drained into an approved dump station. Both black and gray water holding tanks must be drained and rinsed thoroughly on a regular basis in order to prevent the accumulation of harmful or toxic materials.

Whenever possible, drain the holding tanks prior to traveling. The carrying capacity of your unit will be reduced if water is left in the black or gray tanks.

The holding tanks should only be drained when they are at least 3/4 full. By doing this, sufficient water is allowed the complete flushing of waste materials in the drain lines and hose. If the tanks are not 3/4 full, add enough water to allow for sufficient flushing.

To empty the waste water tanks, connect the adapter to the drain hose. Use the adapter supplied with your unit. If the adapter is lost or broken, one can be purchased from any RV supply store. Once you have placed the adapter on the drain hose, it can remain there for the life of the hose. One end of the hose threads up through the hole in the bottom of the service compartment, and the other end of the hose feeds into the sewer at the dump station. Unscrew the cap off the drain. Connect the hose with the adapter in place to the drain fitting. Open the gate valve all the way by pulling on the T-handle. The tank will start to drain as soon as the T-handle is pulled. After you have drained the black water tank, immediately drain the gray water tank. Doing this helps to flush the black water from the sewage hose.

When both of the tanks are empty, flush them with a fresh water rinse before you close the valves. The gray tanks are easily flushed by pouring a couple of gallons of water into a sink drain. The drain outlet is engineered for quick release of the drain hose adapter. Always close the gate valves and secure the end cap to prevent leakage while in transit. After draining the black water tank, it is recommended to add a holding tank deodorant (such as Thetford Aqua-Kem) to help control the odor and break down the solids. Follow the instructions given on the holding tank deodorant package.

When using dump stations for draining the holding tanks, please keep other travelers in mind. Practice good housekeeping. Leave the dump stations in good order. Above all, do not pollute.

### **Camping with Sewer Hook-Up**

When camping at parks with sewer hook-up, it is important to keep the black water holding tank gate valve closed at all times, except when dumping. The gray tank can be kept open while hooked to a sewer connection but again; the black water tank must be kept closed. This is done so that an ample supply of liquid remains in the tank to provide a smooth flow through the gate and drain valve when dumping. Sufficient liquid in the tank causes a swirling action that should take any accumulated solid wastes with it. Accumulation of solid wastes in the black water tank can be avoided by keeping the gate valve closed when connected to the sewer hook-up. If the valve is left open, solid wastes may accumulate in the tank. This may eventually result in costly repairs.

## **CAUTION**

The gray tank valve must be in the open position when operating the optional washing machine.

### No Fuss Flush

This unit is equipped with a flushing system for the holding tanks. When draining your sewer tank, attach a water hose to the sewer spray hookup. After the tank is drained, **leave the gate valve open** and open the water valve to allow water to spray inside the sewage tank. This will clean the inside of the tank of any debris that may be left inside the tank. After this is done, disconnect the freshwater hose and close the gate valve. When unsure if any solids are still left inside the tank, fill the sewage tank with approximately ten gallons of water through the stool. As you travel the agitation of the water should help liquefy any solids left in the tank. You can dump the sewage tank again at your next destination.



### CAUTION

Do not use the same hose for the No Fuss Flush that is used for filling the fresh water tank. Also, the gate valve to the sewage tank **MUST** be in the OPEN POSITION while rinsing with the No Fuss Flush system.





## SLIDE OUT FEATURES

### SLIDE OUT FEATURES

#### **WARNING**

**Read the following slide out room instructions before activating the switch.**

Do not allow children to operate the slide out.

Do not allow any person to place their arms, legs, body or head between any pinch point of the lock arms, slide out fascia, interior walls, exterior walls, objects, or floor as serious injury or death could result.

Any adjustments, or repairs, must be made only by “NEWMAR” qualified personnel.

Always check the interior and exterior of the coach for objects, or persons, that are in the path of the slide out when extending or retracting the room.

Always check the roof to be sure any objects, or debris, are removed before retracting the room.

#### **CAUTION**

It is recommended that the leveling jacks be extended and the unit level before operating the slide out. Note: This slide out can be operated without utilizing the leveling system, but is recommended to have the unit as level as possible.

Your unit is equipped with at least one power slide out room. It is important that you read and understand **ALL** directions, both in this Owner’s Guide, and on **ALL** the labels affixed inside your unit **PRIOR** to operating your slide out room(s).

Depending on the type of locking mechanism (manual or power) used on your slide out rooms, your unit will contain labels with operating and safety information. Regardless of lock type, there are a number of precautions that **MUST** be observed every time the rooms will either be extended or retracted. For your personal safety, and to prevent potential damage to the slide out mechanism and room, it is paramount that these directions be followed completely. Slide out operation has changed for all 2006 or newer RV’s, and it is important that you understand the operation procedure completely and observe all safety precautions to insure safe, proper operation.

All Slide Out labels contain the following warning:

#### **WARNING**

**Do not allow children to operate the slide out.**

**Do not allow any person to place their arms, legs, body or head between any pinch point of the lock arms, slide out fascia, interior walls, exterior walls, objects, or floor as serious injury or death could result.**

**Any adjustments, or repairs, must be made only by “NEWMAR” qualified personnel.**

**Always check the interior and exterior of the coach for objects, or persons, that are in the path of the slide out when extending or retracting the room.**

**Always check the roof to be sure any objects, or debris, are removed before retracting the room.**

## General Instructions



### IMPORTANT

The slide out room should be inspected for alignment every six (6) months. If alignment is necessary, have the room adjusted.

### Operating the Slide Out Room (w/manual locking arms)

1. Verify the coach is either plugged into shore power or is under generator power.
2. The windows on the end of the slide out room must be closed before moving the room in either direction.
3. Before extending or retracting the room, look for and remove any obstructions.
4. Move the driver's chair forward before moving the slide out room in either direction.
5. Disengage the lock arms by pulling down on the center of the arm using the lock arm release tool, as required.
6. Activate the slide out switch in the desired direction to either extend or retract the room. **Please note that you must hold the slide out switch for the duration of movement of the room.** If the switch is released during room extension or retraction, the room will stop moving. When the room has reached full extension or retraction, the slide out will automatically stop.
7. If retracting the room, be sure to engage the lock arms for the slide out room as soon as it has fully retracted.



### IMPORTANT

The slide out room can be stopped at any time by releasing the slide out switch. If the slide out room stops before reaching the full "OUT" or "IN" position, the slide out controller may need adjustment. To adjust the slide out controller, turn the adjustment screw clockwise to increase the power and counter-clockwise to decrease the power. Move the adjustment screw in small increments. Try moving the slide out room again. Use caution. There is a potential for component or structural damage if the screw is adjusted too high. This screw does not adjust the slide out room speed. It sets the amount of power required to move the room against the mechanical stops.



### IMPORTANT

On units equipped with **manual lock arms**, it is important to release the switch as soon it has pulled tight and stopped moving. Current will be applied to the slide out motor as long as you hold the switch. Automatic resetting circuit protection is incorporated to minimize the chance of failures from not releasing the button at the end of room travel, but timely releasing of the button before the circuit protection engages is highly recommended.

## MANUAL EXTENSION AND RETRACTION

The slide out room may be manually retracted. Before attempting to manually extend or retract a slide out room, please contact your servicing dealer or call Newmar Customer Support at 1-800-731-8300.

## **IMPORTANT**

The TRANS-TORQUE bushing must be re-tightened to re-couple the slide out gear motor before moving the coach. This will hold the slide out room in place. The correct torque on the 1 1/2" TRANS-TORQUE bushing is 110 foot pounds maximum. The correct torque on the 1 1/2" TRANS-TORQUE bushing of the K-900 motor (center shaft motor) is 125 foot pounds maximum. Slide outs with either the center or end mounted motors can be moved by pushing the room the full length of its travel in either direction. This method will require the assistance of at least two people.

## Operating Precautions

### **WARNING**

Before extending the slide out, make certain that there is a minimum of five (5) feet of clear space on the slide out side of the unit. Prior to extending the room, be sure to unlock the slide out locking arms. Make sure there are no obstructions either inside or outside the unit that may interfere with the slide out extension. Tree branches, bushes or telephone poles can cause extensive damage to the exterior of the unit.

### **CAUTION**

It is recommended that the leveling jacks be extended and the unit level before operating the slide out. Note: This slide out can be operated without utilizing the leveling system, but is recommended to have the unit as level as possible.

## **IMPORTANT**

It is important to clean the slide out rollers under the floor regularly as dirt may adhere to the rubber coating on these rollers and cause damage to hard surface flooring. Such damage is not covered under warranty. These rollers may leave indentations in carpeting, linoleum and other flooring. This condition is normal and does not warrant flooring replacement.



## ROUTINE MAINTENANCE

### EXTERIOR CARE



#### IMPORTANT

Damage caused by improper or unapplied maintenance is not covered by your Newmar Limited Warranty.

#### Washing your RV

The clear coat used on all painted Newmar RV's is a similar to the technology that used by car manufacturers. It is baked in our "state of the art" bake booths which cures the clear coat. The end result is a Masterpiece Finish™ which is the highest quality in the industry. The same care needs to be performed and maintained on your RV exterior surface as on your Automobile.

- Make sure the RV's surface temperature is under 90° F, and is not in direct sunlight.
- Rinse the entire coach to remove all loose dirt and grime. Never hold a pressure washer close to the surface. Use a fan type spray nozzle, making sure that the water coming out of the gun has a fan and not a single straight stream.
- Most car stores offer mild car wash shampoos that are safe for clear coat finishes. We would recommend using baby shampoo as it will not leave a film on the coach. Adding ½ of a cup of food grade vinegar to the water will boost the cleaning ability of any cleaner and also soften the water. This also helps to minimize water spots. **Do not use dish soap, detergents with degreasing agents, or industrial cleaners as they can cause damage to the finish.**
- Use 100% cotton or Lambswool pads or wash mitts for washing the painted surfaces of your RV. Use a different mitt for washing the wheels and undercarriage. Please contact your Newmar dealer to order these Newmar parts. (**Lambswool pad:** 018461; **Backer Pad:** 018461A; **Lambswool mitt:** 018464; **Extension pole:** 018463)
- Change water in your wash bucket often or place a "dirt guard" in bottom of the bucket to keep the cleaning pad or wash mitt free of dirt and debris.

**ABSOLUTELY NO BRUSHES SHOULD BE USED ON THE PAINTED SURFACE. USE OF THESE ON YOUR RV'S PAINTED SURFACE WILL CAUSE DAMAGE TO THE FINISH, AS IT WOULD AN AUTOMOBILE FINISH. NEWMAR DOES NOT SUPPORT USING ANY STYLE, TYPE, MATERIAL OF BRUSH EVEN THOUGH IT MAY BE MARKETED AS "RV SAFE" OR "APPROVED."**

**Damage caused by inappropriate or unapplied maintenance is not covered under warranty as expressed in the Newmar Expressed Limited Written Warranty.**

#### Drying your RV

Drying your RV is just as important as washing it. Today's tap-water and well-water contain many chemicals that could water stain your RV's finish.

After washing, dry your RV with the **EZE Squeegee** (# 018462) or a clean 100% leather chamois. You can also use fresh Microfiber towels for drying. Please use caution as these towels are made partially with polyester (*which is plastic*) which can break down over time from extended use and washing, eventually causing damage to the clear coat finish.

 **IMPORTANT**

Never use a strong solvent, such as lacquer thinner or harsh abrasives, on any of the exterior painted surfaces.

**Waxing**

The exterior finish will require a routine waxing. When water will not bead and roll off a freshly washed vehicle, a new coat of wax is needed. Wax not only improves the appearance of the vehicle, but it also protects the finish against oxidation and corrosive materials. The recommended type of wax is one that is compatible with painted or gel-coated fiberglass finishes, and contains a UV (ultra-violet) inhibitor. Buffing with a polishing compound will improve a dull or discolored finish.

 **IMPORTANT**

When using a polishing compound that does not contain a wax preservative, reapplying a coat of hard wax after polishing is recommended.

**Seals**

The seals around doors, windows, vents, slide out trim and external seams should be checked at least twice a year. In addition, the roof seams should be inspected twice a year for cracking or peeling. If deterioration is noted during a routine maintenance inspection, reseal the seams or seals with an approved sealant to prevent leaks. Your dealer can perform the resealing inspections and work for you. It is recommended that a Newmar Authorized Service Center perform these inspections, and reseal when necessary.

<b>Proper Sealants for Application</b>	
<b>Plas-T-Cote</b> .....	<b>Metal or fiberglass roof</b>
<b>Surebond #SB-140</b> .....	<b>Rubber laminated to metal roof and all skylights.</b>
<b>Carlisle #502-LSW</b> .....	<b>Rubber roof over wood Base</b>
<b>Self-Leveling Sealant</b>	
<b>Silicone Sealant</b> .....	<b>To cover butyl and other sealants; not to be used as the main sealant</b>
<b>Parbond</b> .....	<b>To seal across tops of windows, etc. on exterior where silicone is not used</b>

**Striping & Decals**

The striping and decals on your vehicle require little maintenance. Treat these as you would any painted surface on your vehicle. Wash them with mild soap and water, or any retail car soap. Never wash the vehicle in direct sunlight, while the vehicle is hot or with hot water. Rinse thoroughly to prevent soap residue accumulation. Use caution with high pressure wash nozzles.

Keep them at least 18 inches from the edge of the decals. High pressure water may cause the decals to loosen and peel. Test small sections of decals when using any type of cleaning solution.



## **IMPORTANT**

Do not use solvents such as acetone, MEK, toluene, etc. on the decals. Any solvent including alcohol may soften or smear colors. Do not use lacquer thinner or paint on decals. Do not overcoat the decals with clear paint. Do not allow her fuels to drip or stay on the decals for any length of time. If this occurs, immediately flush the area with water.

## **Wheel Care**

The care and maintenance of your chrome aluminum wheels is simple and requires no special material or products. Timely care and cleaning will keep them looking great for many years. We suggest the following care:

- 1.** Clean your wheel on a regular basis to keep road dirt from building up.
  - A.** Rinse with clean water to remove loose dust and dirt.
  - B.** Clean with a mild soap and water solution. (Any non-abrasive household detergent works fine.) Apply with cloth, sponge, or soft bristled brush. Use solution liberally to avoid surface scratching due to trapped dirt on the applicator.



## **IMPORTANT**

Do not use harsh detergents, acids, or abrasives which may scratch or dull the surface. The applicator cloth, sponge, or soft bristled brush should be non-metallic and non-abrasive

- C.** Rinse thoroughly with clean water to remove excess soap and dirt.
  - D.** Repeat above steps as required.
  - E.** If stubborn stains persist, such as road tar, brake dust, oil, etc., use only a product compatible with stainless steel. An over-the-counter window cleaner (like Windex) will often remove foreign material. If a harsher cleaner is needed, we recommend “NEVR-DULL,” available at many general hardware or automotive stores.
- 2.** Surface rust: From time to time, surface “spin out” rust may appear on the stainless steel. Normally the "spin out" rust comes from the wheel, lug nuts, locator pins, etc. In many cases, regular normal cleaning of your decorative wheel product, as indicated above, will remove any surface rust. If, however, a stubborn rust spot remains, utilize “NEVR-DULL” (a wadding polish), applying constant pressure to remove any surface blemish. You may have to repeat this process on hard to remove spots. After cleaning with “NEVR-DULL,” you may want to re-shine your wheel products using Windex or a similar product.
  - 3.** Petroleum based tire conditioners: While the use of these products (Armor-All, Son-of-a-Gun, etc.) may improve the appearance of your tires, these types of products will form a film on your stainless steel wheel cover product. To remove, use a mild cleanser, like Windex, to restore the shine.





## IMPORTANT

Remember to periodically check the tightness of your wheel cover product.

### Rubber Roof Care & Maintenance

Proper care and maintenance of your recreational vehicle, including your rubber roof, is important for trouble-free performance. Normal maintenance is simple and easy, and does not require special materials. Keep the roof clean. Clean the roof at least four (4) times annually. For normal cleaning:

1. Use RC100 Decor Synthetic Roof & General Purpose cleaner or a mild laundry detergent.



## CAUTION

Do not use general purpose cleaners or conditioners containing petroleum solvents, harsh abrasives or citric-based cleaners. You may cause irreparable damage to your roof.

2. Rinse the complete roof with clean water to remove any loose dirt or debris.
3. Using a medium bristle brush, along with your selected cleaner mixed with water, scrub the entire roof. Rinse thoroughly with clean water to avoid residue build up on the roof or sidewalls of the vehicle.
4. For more difficult stains, you may use cleaning materials mentioned above in a more concentrated mixture. For stubborn stains, use of a cloth dampened with household bleach. Household bleach can be used (fully concentrated) and allowed to soak in stubborn stain areas, then scrubbed with a medium bristle brush or rag. Rinse thoroughly. Do not pour the bleach on the roof and allow it to run down the sides of the vehicle. Concentrated bleach may damage the graphics.



## WARNING

Use caution when working on top of your vehicle. The wet roof membrane may be extremely slippery.

### Battery Inspection & Care



## WARNING

Remove rings, metal watch bands, and other metal jewelry before working around batteries. Use caution when using metal tools. If a tool contacts a battery terminal or metal connected to it, a short circuit could occur which could cause personal injury, explosion or fire.



## CAUTION

Disconnect the 120 volt electrical power cord and the negative terminal from the coach batteries before working on the electrical system.

Remember that when batteries are not used for an extended period of time, they may lose their charge. Periodic charging of the batteries during storage of the unit will increase the life of the battery. Check the external condition of the battery periodically. Look for cracks in the cover and case. Check the vent plugs and replace them if they are cracked or broken. Keep the battery clean. Accumulations of acid film and dirt may permit current flow between the terminals, which could drain the battery.

To clean, wash the batteries with a diluted solution of baking soda and water to neutralize any acid present. Rinse thoroughly with clean water. Foaming around the terminals or on top of the battery is a sign that acid is being neutralized. Avoid getting the baking soda solution in the battery. Secure all vent caps. Dry the battery cables and terminals to prevent corrosion. Do not use grease on the bare metal inside the cable terminals. Grease can act as an insulator, and electricity will not flow through it. A plastic ignition spray will protect the terminals after they have been cleaned.

## **WARNING**

Do not allow the battery fluid to contact your skin, eyes, fabric, or painted surfaces. The fluid could cause serious personal injury or property damage. Wear eye protection when working with any battery.

The batteries should be removed and stored in a warm place when not using your motorhome for an extended period of time. Mark the cables, positive and negative, for easy identification. Batteries are not to be stored on concrete floors. The batteries require periodic charging during storage. If the motorhome is to be stored for a long period of time, it is recommended that all of the batteries inside the unit be removed from clocks, radios, smoke alarms, etc. This will prevent unnecessary drain and corrosion of the batteries. The coach batteries are 6 volt RV/Marine deep cycle batteries. This type of battery consumes water and must be filled periodically. Please be sure to check the battery water level on a regular basis. Consult the owner's manual supplied by the battery manufacturer.

## **INTERIOR CARE**

### **WARNING**

Urea-formaldehyde is used in the productions of particle board, hardwood plywood, and most paneling. Urea-formaldehyde resin may release formaldehyde vapors into the air, which may cause headaches, and in some people, eye, and nose and throat irritation. Formaldehyde may intensify some allergies or upper respiratory problems like asthma. Providing proper ventilation as needed by operating the power roof vents and opening windows should reduce the risk of such problems.

### **IMPORTANT**

The fading of upholstery, carpet and other interior fabrics is generally caused by excessive sunlight. The drapes, blinds or shades should be kept closed when the vehicle is parked for an extended period of time to minimize the fading. Normal deterioration of appearance items due to wear and/or exposure is not covered by the Newmar Limited Warranty.

## **Carpet**

A weekly routine of vacuuming the carpet and fabrics throughout the vehicle is recommended. Doing this will prevent an accumulation of dirt that can detract from the materials appearance and shorten its life. Remember to empty or replace vacuum bags before they become half full. In carpet areas that receive the most sunlight, close the curtains frequently to prevent fading. Act quickly to clean up when anything is spilled or dropped on the carpet.

Included in the Owner's Information Package is the carpet manufacturer's Carpet Care Guide. The Carpet Care Guide lists detailed information on cleaning soiled areas and removing stains from the carpet installed in the unit.

## Fabrics

The fabrics used in this motorhome for the bedspread, draperies, headboard and valances contain fire-retardant additives that may be damaged by use of improper cleaning products. Cleaning instructions for these items are DRY CLEAN ONLY.

Water-based products are not recommended for cleaning the fabrics in your new unit. Most water-based household cleaning products are not formulated for use on these fabrics and may cause excessive shrinkage or fading. For best results, the fabrics in this unit should be cleaned by a professional carpet and upholstery cleaner.

Spills, spots or stains should be treated as soon as possible to avoid permanent damage. If a spill occurs, blot the fluid with a dry towel. Do not rub the spill. Rubbing may cause the liquid to "set" in the fabric. When attempting to clean a spot or stain, always start from the outside and work inward to avoid spreading it further. Some stains or soils are extremely difficult or impossible to be removed completely.

These should receive immediate, professional attention. Spills, spots, stains or soils are the responsibility of the owner, and are not covered by the Newmar Limited Warranty.



## WARNING

When cleaning the upholstery and fabric in the unit, do not use lacquer thinner, nail polish remover, laundry soaps or bleach. Never use carbon tetrachloride or gasoline for cleaning purposes. These items may cause damage to the materials being cleaned, and most are highly flammable.

## Walls & Ceiling

The wall and ceiling coverings should be cleaned periodically to maintain a new appearance. Use a non-abrasive cleaner with a soft cloth on the walls. Do not use solvents of any kind. Solvents may damage the surface.

## Dash

In order to keep the dash in like-new condition, follow these guidelines:

### Do—

- Dust and clean the dash with a soft, damp cloth, or chamois, wiping the surface gently.
- Use a mild detergent and lukewarm water.
- Dry the surface, after washing and rinsing, by blotting with a damp cloth or chamois.

### Do Not—

- Use harsh chemicals that may damage the dash.
- Use cloths containing grit or abrasive particles or kitchen scouring compounds to clean or dust the dash.
- Subject the dash to hard, direct blows.
- Use boiling water, strong solvents or other materials listed below to clean the dash, as they will soften the plastic.

## Woodwork

The wood cabinetry should be cared for with furniture polish to sustain the natural beauty and luster of the wood. This will also keep your cabinetry looking new, and prevent the wood from drying. The simulated plank flooring should be protected from dents, scratches and nicks by installing protective pads on the bottom of chairs and tables. Use of area rugs and floor mats by the entrance door is recommended to trap dirt. To clean the flooring, begin by vacuuming the floor to remove loose dust and dirt. Then, damp mop the floor with one ounce of Wilsonart Flooring Cleaner diluted in one gallon of clean, warm water (or use a non-abrasive, soap-free cleaner). The mop should be damp, not dripping. Do not use soap-based cleaners, scouring powders, steel wool, abrasive cleaners, wax or polish on the floor. To remove stubborn spots like shoe polish, oil, tar, markers, scuffs, etc., use a household solvent, acetone or nail polish remover, then wipe with a damp cloth. To remove chocolate, grease, juice or wine, use warm water and a non-abrasive cleaner.

To remove candle wax or chewing gum, carefully scrape off when the material has hardened. For further tips, please see the manufacturer's information sheet in your Owner's Information Package.

## Counter Tops

To properly care for the countertop in your new unit, always use a heat pad or trivet to protect the surface from hot objects that may mar or damage the surface. Also avoid cutting directly on the surface and avoid using harsh chemicals on the counter top. Wipe the counter top with a damp cloth to remove water spots. For most dirt and stains, wipe with a damp cloth and use soapy water or ammonia-based cleaners.

## Accessories

The light fixtures, bath accessories and faucets can be cleaned by wiping with a soft, damp cloth. Washing with warm water will remove dry water spots. Do not use cleaners that contain harsh or abrasive chemicals. Alcohol or similar solvents should never be used.

## Detectors

The CO and Propane detectors are self-contained and DO NOT require any maintenance other than normal cleaning and dusting. The smoke detector installed in this coach is 9 volt battery operated. The battery needs to be tested periodically and replaced when necessary. Please check your smoke detector for the manufacturer's expiration date. When cleaning the case on any of the detectors, use a damp cloth or paper towel. Do not spray cleaners or wax directly into the case as it may cause false alarms.

## Condensation



### IMPORTANT

Since surface condensation within the coach cannot be controlled by the manufacturer, damage caused by condensation is not covered by your Newmar Limited Warranty.

Damage may occur to your unit if excessive condensation exists. Accumulation of condensation on surfaces within your unit occurs when warm, moist air contacts a cool surface. It is most evident on the inside of windows. This problem can be controlled by:

1. Slightly opening a window or roof vent to allow the moisture to escape from the unit.
2. A small dehumidifier is also very effective in removing moisture from the air.

- Condensation levels are highest during times when a person is cooking or taking a shower in the unit, but these are not the only times condensation is present.
- Condensation can migrate through ceiling panels and saturate the fiberglass insulation in your ceiling cavity. This condition often causes the occupants to believe the recreational vehicle has a roof leak. Walls and ceiling panels may also become wet when the moisture accumulates on these surfaces.
- Newmar Corporation does not recommend the use of any catalytic heaters.

## ROUTINE MAINTENANCE



### IMPORTANT

Always follow the chassis maintenance guidelines found in the chassis manufacturer owner's manual.

All routine maintenance is the responsibility of the owner and is not covered by the Newmar Limited Warranty. Please note that damage caused by improper or unapplied maintenance is not covered by the Newmar Limited Warranty.



### IMPORTANT

Cosmetic adjustments and alignments must be performed within the first three (3) months from date of original purchase for warranty consideration. Thereafter, these items are considered routine maintenance.

Items supplied by other manufacturers may require specific individual maintenance not listed herein. Please refer to the manufacturers' suggested maintenance guidelines in the Owner's Information Package.

### Monthly

- Check battery water level.

### Every Three (3) Months

- Clean range hood exhaust fan filter and blades.
- Check gas lines for leaks with soap solution or leak detector.
- Test smoke alarm, carbon monoxide detector and Propane gas detector.
- Check operation of windows, latches and hinges.
- Clean the roof ducted air conditioner filter(s).
- Clean and inspect all door and window seals; reseal where necessary.
- Inspect and reseal around the tub and shower area where necessary.
- Lubricate the exterior door hinges and latches with a graphite (silicone) lubricant.
- Check, clean and tighten battery cables, and inspect batteries for proper fluid level.

### Every Six (6) Months

- Inspect the slide out for proper seal. If realignment is necessary, please contact an Authorized Newmar Service Center.
- Inspect the exterior rubber slide out seals and apply a UV inhibitor, such as 303 Protectant.
- Rotate tires as recommended by the tire manufacturer.
- Check all gas appliances for proper operation.

- Have the Propane system inspected by a qualified technician.
- Lubricate the moveable parts on the entrance step.

## Annually

- Inspection of roof seams and joints should be performed by an Authorized Newmar Service Center. If resealing is necessary, it is the owner's responsibility and is not covered by the Newmar Limited Warranty.
- Sanitize the fresh water system.
- Wax and buff all gel-coat surfaces on the vehicle as described previously in this chapter.

## Winterizing

To store your unit for the winter months, it is necessary to winterize the water system to help prevent freezing. To do this, follow these instructions:

1. The water heater must remain off during this process. Shut off the water pump and make sure the water supply valves are closed.
2. To drain the fresh water tank, open the drain valves.
3. Open the low point drain valves. There is one drain valve for each water line, one cold and one hot. This is done to drain all of the water out of the system.
4. After the water heater has cooled off, remove the drain plug to drain the water from the water heater. In the exterior compartment beside the water heater there are two water heater shut off valves and a by-pass valve. The shut off valves must be closed and the by-pass valve must be open, prior to winterizing to prevent the antifreeze solution from entering the water heater.
5. Close the low point drains to prevent the antifreeze from draining through the lines onto the ground.
6. Remove the water filter. See Chapter 7 for more information.
7. Close the water supply valve that flows from the pump to the tank.
8. Use only non-toxic antifreeze that has been approved for use in drinking/potable water systems. Place the in-take hose into the antifreeze supply. Open the antifreeze valve to allow the solution to flow freely. Once the water pump is turned on, proceed to the kitchen faucet, bath faucet, inside and outside shower, turning on the hot and cold, and flushing the stool until the antifreeze solution flows freely. If the unit is equipped with a washer, be certain to purge the air from it also. This forces the antifreeze through all of the water lines and faucets. It also allows the antifreeze solution to enter the drain lines and prevent the P-traps from freezing. Check the antifreeze solution from time to time to make sure there is an adequate supply.
9. Close the antifreeze valve when the winterizing process is complete. Store the in-take hose, and turn the water pump off.
10. Open the water supply valve that flows from the pump to the tank to help prevent freezing on that water line.
11. To de-winterize your unit, open both of the low point drains to allow the antifreeze solution to drain from the water system. Next, close the low point drains and connect your unit to city water. Put water in the fresh water tank and pump at least one gallon through the water pump in order to remove the antifreeze from the water pump. Keep the water heater supply valve closed and the water heater bypass valves open. The supply valve for the fresh water tank from the pump must remain closed. As in winterizing, open the kitchen faucet, bath faucet, inside and outside shower, turning on both the hot and the cold, and flushing the stool until the antifreeze solution is flushed out of the system and the water flows clear. Once the system has been flushed, open the water heater supply valve and close the water heater bypass valve. Open the fresh

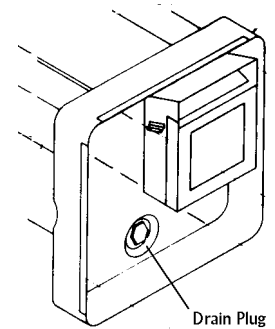

water tank supply valve from the pump and the ice maker valve. Reinstall the water filter. Be sure to close the fresh water tank drain valves to allow the tank to fill.

**Note:** Remember, if your unit has the exterior shower installed you must winterize this system as well.

## Head Lamps

Recreational Vehicle headlamp maintenance recommendations while your vehicle is parked for long periods:

1. Check headlamp regularly for condensed water drops (daily in high humidity areas).
2. If small drops of condensed water are noted, drive your RV with the headlamps “ON” or just turn “ON” the headlamps. This will evaporate the condensed water drops and will help in avoiding the accumulation of water. Depending on the size, shape and location of the lamp on the RV, the atmospheric conditions occurring, the amount of time required to clear the lamp may vary from 2 to 6 hours.

## NOTICE

If water is allowed to accumulate, some stain marks on the reflective surfaces may appear, damaging the surface.

The headlamp seals should not be directly sprayed with high pressure (home or industrial) wash systems..

## Cold Weather Use

Although great care has been taken to build a well-insulated unit, recreational vehicles are not intended for extended use in subfreezing weather without special precautions.

When the temperature drops below freezing, the furnace must be turned on to keep the unit warm. Continued use in cold weather will require the unit to be winterized.

