



WHEN YOU KNOW THE DIFFERENCESM

50th
Anniversary Edition

2018 **Dutch Star**

2018 DUTCH STAR OWNER'S GUIDE



NOTICE

This Owner's Guide is published and printed from Newmar's online knowledgebase. All of the information in Newgle is believed to be accurate at the time of publication. However, it may be necessary to make revisions, and Newmar reserves the right to make any such changes without notice or obligation. For the most up-to-date version of this content, and for more product-specific information, please refer to Newgle.

Chapter 1: Introduction

- 1 A Letter from Our Family to Yours
- 3 Introduction to Newgle
- 6 Safety Notices in Newgle
- 6 Warranty and Service
- 7 About Your Owner's Information Package
- 7 About the Delivery Process

Chapter 2: Safety

- 9 Placards and Labels
- 9 Before Driving Away
- 10 Driving in Dangerous Conditions
- 10 Seat Belt Safety
- 12 Fire Safety
- 14 Carbon Monoxide Safety
- 15 LP Safety

Chapter 3: Care and Maintenance

- 19 How to Wash and Dry a Coach
- 20 Waxing and Polishing a Coach
- 21 How to Winterize a Coach
- 24 How to De-Winterize a Coach
- 24 How to Sanitize the Complete Water System
- 26 How to Care for and Maintain the Dash
- 27 How to Weigh a Coach
- 29 Routine Maintenance Schedule

Chapter 4: Appliances

- 32 Cooktops and Ranges
- 34 Dishwashers
- 34 Fireplaces
- 35 Microwaves and Convection Ovens
- 35 Refrigerators, Freezers and Ice Makers
- 36 Vacuums
- 37 Washers and Dryers

Chapter 5: Chassis

- 39 Chassis Monitoring Systems
- 39 Freightliner
- 40 Fuel Systems
- 41 Leveling Systems
- 45 Spartan
- 46 Steering Systems
- 46 Wheels and Tires

Chapter 6: Electrical

- 49 12 Volt Electrical System
- 53 120 Volt Electrical System
- 59 Batteries
- 65 Cord Reels
- 66 Dash Electrical Systems
- 66 Energy Management Systems
- 66 Fuse Panels
- 68 Generators
- 70 Inverters and Converters
- 71 Lighting
- 71 Receptacles and Accessory Chargers
- 72 Solar Power
- 73 Transfer Switches

Chapter 7: Electronics

- 75 Camera and Video Monitoring Systems
- 75 Holding Tank Monitoring
- 77 Lighting Controllers
- 78 Navigation Systems
- 78 Security and Keyless Entry Systems

Chapter 8: Entertainment Systems

79	Antennas, Cable, and Satellite Systems
80	Blu-ray Players
80	Dash Receivers, CD Players, and Stereos
81	DVD Players
81	Infrared Receivers, Remotes, and Switchers
81	Stereo Receivers and Home Theater Systems
81	Televisions and Television Lifts

Chapter 9: Exterior

83	Air Horns
83	Awnings
84	Compartments
85	Doors, Handles, and Chimes
85	Entrance Steps
86	Exterior Lights
87	Hitches and Towing Components
87	Mirrors
88	Paint, Roof, and Siding
90	Wheelchair Lifts
90	Windows
91	Windshields
92	Wiper Systems

Chapter 10: HVAC

93	Air Conditioning, Dash
94	Air Conditioning, Roof
94	Fans and Ventilation
95	Hydronic Heating
97	Radiant Heating
97	Thermostats

Chapter 11: Interior

99	Beds and Mattresses
99	Cabinetry and Woodwork
101	Ceiling
101	Countertops
102	Fabrics and Interior Furnishings
102	Flooring
104	Furniture
106	Interior Doors and Hardware
106	Interior Steps and Step Covers
107	Shades and Window Coverings
107	Walls

Chapter 12: Plumbing

109	Bathroom Faucets and Fixtures
109	Filters
110	Fresh Water System
113	Hose Reels
113	Kitchen Faucets and Fixtures
113	Power Washers, Sprayers, and Exterior Showers
114	Sinks
114	Toilets
115	Tubs and Shower Enclosures
116	Waste Water System
120	Water Heaters
121	Water Pumps

Chapter 13: Slideouts

124	Electric Bedroom Slideouts
128	Electric Flat Floor Slideouts
130	Electric Full Wall Slideouts
133	Electric Kitchen Slideouts
136	Electric Wardrobe Slideouts
139	HWH Hydraulic Flat Floor Slideouts

A Letter from Our Family to Yours

Welcome to the exciting world of recreational vehicle traveling and the growing Newmar family!



WHEN YOU KNOW THE DIFFERENCE.SM

Congratulations on your purchase of a Newmar product. Your coach proudly carries the Newmar torch, as a new generation of RV'ing begins. We share your excitement at this moment, and with you look forward to the years and miles of adventure the RV lifestyle offers you in your coach. Whether camping at your favorite remote fishing hole or tailgating at the big game with your friends, have fun and relax, knowing that Newmar is with you 24 hours a day, 7 days a week.

The Newmar Legacy

Your new coach was built with care using today's technology and old world craftsmanship. At Newmar, we strive to build vehicles that are safe, dependable, and comfortable. Born on Christian principles, and from the desire to build not the most, but the best, the legacy associated with the name Newmar is one of family pride and quality. It is the culmination of decades of RV design and building experience. We take humble pride in our history of innovation. We introduced the industry to the first slideout rooms, and continued our tradition of innovation with the first flush floor slideout in a motorized coach and the smooth, seamless fiberglass body. Your coach is at the forefront of current technology, built by the skilled hands and quality conscious eyes of craftsmen.

At Newmar, we recognize that a craftsman's final product is only as good as the materials they use, so we are selective about what we put into our coaches. We start with a foundation forged in the strength of steel and aluminum. We fill it with beautiful, durable hardwoods, and select name brand appliances and components, then build it on a chassis built to stand the test of time. Then we finish our units with an artist's gentle touch.

The Newmar Warranty

Your coach has been built to the highest standards. That's why we back it with a 12-month limited warranty, the best warranty in the industry. A heritage of quality and dependability makes it easy for us to offer that kind of coverage. Please read the Newmar Limited Warranty and all other component warranties that apply to the equipment installed on your unit. The limited warranties issued by the chassis and component manufacturers require periodic service and maintenance. The owner's failure to provide this service and/or maintenance may result in the loss of warranty coverage. Be sure to file the appropriate registration card with the component manufacturer as described with the individual instruction booklets to activate the warranties on the components within your Newmar coach.

Customer Support

Carefully read both the instructions in your Owner's Guide, as well as the booklets supplied by the chassis and component manufacturers for important operation, safety, and maintenance information. This Owner's Guide should be kept in your vehicle for quick reference. Take time to get acquainted with your unit and how it operates. Should you have any questions, consult your dealer or the Newmar customer support team. In addition to the assistance you receive from the customer support team, we are also excited to announce a new approach to customer service: Newgle.

Your coach owner's guide is printed directly from Newgle, Newmar's dynamic, multi-faceted knowledge center created specifically for Newmar coach owners and certified technicians. Because content pertaining to your coach is constantly evolving and changing, the only way we can provide you with access to the most up-to-date and relevant information is by linking you directly to it! Much of our information comes directly from the manufacturer of the items that are specific to your coach model and year, so we urge you to check out the site for any additional information that may not (currently) be included in your owner's guide. For more information on Newgle, refer to the Newgle information page in this section of your owner's guide.

Our customers are extremely important to us, and we will make every effort necessary to ensure your satisfaction.

Contact Newmar

- Phone: 800.731.8300
- Mail: P.O. Box 30 | Nappanee, Indiana 46550-0030
- Websites: www.newmarcorp.com and <https://newgle.newmarcorp.com>

Introduction to Newgle

Welcome to the wonderful world of Newgle! As a Newmar coach owner, Newgle provides you with access to content pertaining to your specific model and year. Whether you are using the search bar or the drop down navigation featured on every page, you have the ability to locate the information you need with the click of a button.



Newgle consists of 12 categories, dozens of sub-categories, and thousands of item-specific links connecting you directly to the manufacturer of the items in your coach! Content is regularly added and is only available to current Newmar owners and certified technicians. Feel free to browse and explore our mobile-friendly website from your tablet or smartphone.



IMPORTANT

Newgle is an ever-changing knowledgebase. The Newgle team strives to introduce new features and content regularly to improve the site. The included screenshots and navigational instructions may change without notice. Always refer to Newgle for the most up-to-date version of this content.

How Do I Access Newgle?

Visit Newgle at <https://newgle.newmarcorp.com> to register for an account. Because you now own a Newmar coach, click the link associated with an owner account, "Coach Owner - Newgle Access Request." You will be asked to provide your coach information and some basic contact information, allowing the Newgle Team to verify ownership and set up an account just for you!

Once your account has been created, you will receive a verification email, which will include your username and password, transporting you to a one-of-a-kind world of knowledge. If you have any questions regarding your login information, please contact your Newmar Model Specialist.

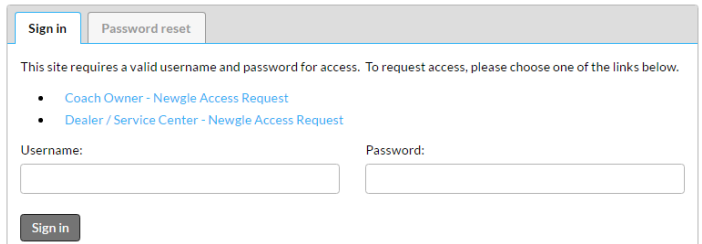

How Do I Navigate the Site?

The Newgle logo is available in the upper left corner of every page throughout the site. Click on the logo at any time to return to the Home page. The Home page displays your user information and provides an introduction to your coach (model and year), as well as access to the Newgle search function, drop-down menus, and category blocks, which are crucial for easy navigation throughout the site.

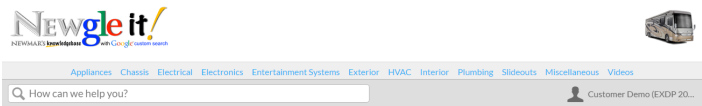

Newgle it! Search

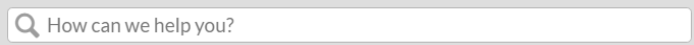

The Newgle it! search bar is also available on every page, making it possible for you to conveniently initiate a search anytime from anywhere within the site.

By using search terms, such as the product name or manufacturer, or by typing in the model number or Newmar part number, you can visit the relevant Newgle pages listed in the search results immediately. You can also view related search results directly from Google.

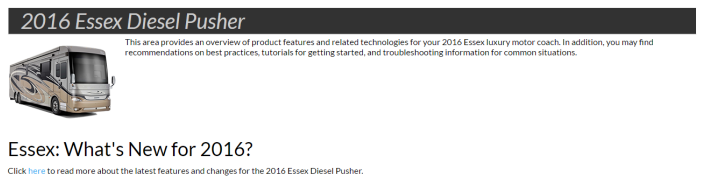

Appliances

Newmar only uses the most convenient and efficient appliances to make maintaining your coach - and your lifestyle - less of a chore. This category provides detailed information regarding each of the appliances available in your coach, including cooktops and ranges, dishwashers, fireplaces, microwaves and convection ovens, refrigerators, freezers and ice makers, central vacuums, washers and dryers, and water softeners.

- Cooktops and Ranges
- Dishwashers
- Fireplaces
- Microwaves and Convection Ovens

Chassis

From the Chassis on up, Newmar coaches are built to be dependable, durable, comfortable, and beautiful. Built specifically for Newmar with the highest quality in handling, safety, performance, and dependability. This category provides detailed information regarding your axles and tires, as well as the collision warning, fuel control, leveling and towable braking systems in your coach.

- Chassis Monitoring Systems
- Collision Warning Systems
- Freightliner
- Fuel Systems

Drop-Down Menu

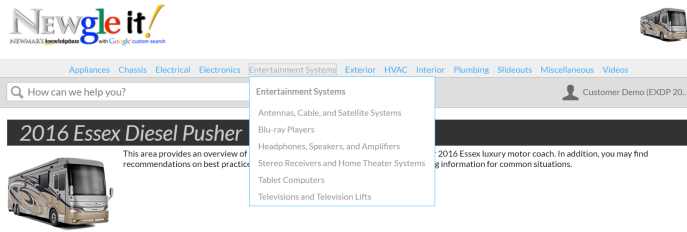

Choosing a category from the drop-down navigation menu along the top of the page will take you to the landing page for that category. From here, you can drill down to the sub-category level, allowing you to view the contents of each category.

Category Blocks

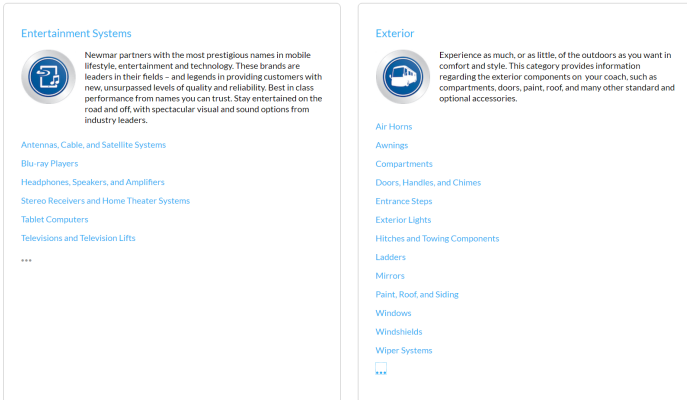

Choosing a category block on the Home page will take you to the landing page for that category. Just like the drop-down menu, you can drill down to the sub-category level, allowing you to view the contents of each category.

To view more sub-categories, click on the set of three horizontal dots at the end of the list. This will expand the view so all of the sub-categories are visible. Click on the set of three horizontal dots again to collapse the sub-category list.

What Type of Information Will I Find?

Categories

Each of the categories includes a brief overview of the type of information you will find within the category and the layers beneath it. The overview may include dangers, warnings, cautions, and important notices to highlight particular aspects of your coach that may require additional attention.

Many categories also include images of labels (some of which may be noted as examples only) that may be posted throughout your coach or on your components.

Click on a sub-category block below the information to view more detailed information about a particular component within the Entertainment Systems category, such as Blu-ray Players.

Sub-Categories

Each sub-category includes basic information about the topic at hand, which may include the location, operation, and function of a particular system or component within your coach.

Below the information is a list of "Item Home Pages" based on the items relevant to your coach year and model. These pages are titled using the manufacturers of the products. Some sub-categories will only display one or two item home pages, such as the Blu-ray Players, because that is the only equipment installed in your coach for that model and year.

Entertainment Systems

Last updated: 10/31/2017

Newmar partners with the most prestigious names in mobile lifestyle, entertainment and technology. These brands are leaders in their fields – and legends in providing customers with new, unsurpassed levels of quality and reliability. Best in class performance from names you can trust. Stay entertained on the road and off, with spectacular visual and sound options from industry leaders.

This section provides information on entertainment components, including televisions, dash-mounted audio equipment, multi-disc players, home theater systems, and satellite antennas. Such components may be located within your coach's living room, bedroom, cargo area, or even outside of your unit in an optional exterior entertainment center.



Exterior Entertainment Center

For your convenience and pleasure, an Exterior Entertainment Center may be an option on selected floorplans. It may be located in either a basement compartment or in the sidewall of the passenger side of the coach. Depending on the year, model, and floorplan of your coach, this entertainment center features an flat screen television, and may feature an AM/FM/CD stereo and speakers to provide outside music when desired. Some coach models feature a sound bar instead, and may also have an audio selector switch.

The television is mounted on a swivel bracket that allows you to swing the television out and away from the coach to provide better viewing angles. To release the television from its retainers, grasp the sides of the television firmly and pull it directly toward you. It will release and swing freely to the desired viewing position. To store the television for travel, swing it back into the opening, making sure that it is fully latched.

The external stereo can be used to listen to AM and FM broadcasts, as well as to play CDs. It may have some of the same functions and features as your in-dash stereo. The television in the exterior entertainment center can also be played through the exterior stereo or sound bar. If equipped with audio selector rotate switch to desired audio input for the sound bar.

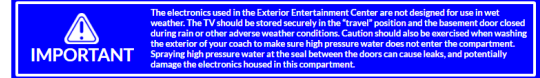

Toy Hauler Garage Entertainment System

This entertainment center incorporates a television and stereo. The television can be used to tune local channels via the antenna (not connected to the DVD player inside the unit). The AM/FM/CD stereo is connected to multiple speakers in the garage area, as well as under the awning on the passenger side of the coach. The speakers can be turned on and off using the switch located inside the cabinet door above the radio.

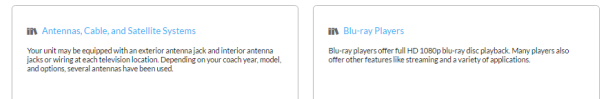

Blu-ray Players

Last updated: 11/30, 19 May 2016

Blu-ray players offer full HD 1080p blu-ray disc playback. Many players also offer other features like streaming and a variety of applications.

Operating Instructions

To operate your blu-ray player, turn it on using the remote or on the face of the player. To insert a blu-ray disk, press the OPEN button, followed by the CLOSE button. Press the PLAY button on the remote or on face of the player. Make sure the proper source is selected on the television to view the blu-ray disk.

For More Information

Refer to the product manufacturer's owner's manual and links to learn more about your coach's blu-ray player.

Item Home Pages

[Sony Blu-ray Players](#)

Sony's Blu-ray players offer a range of media, connectivity, and streaming media options.

Item Home Pages

Once an Item Home Page is selected, you may see basic information about that manufacturer and component, such as operating instructions, care and maintenance, etc. You will also see a list of "Item Home Page Items (IHPi's), or the components that are available (standard or optional) in your coach based on the model and year.

Each item will be titled "Manufacturer Model Number :: Manufacturer and Item Description :: Newmar Part Number."

Click on the item model to view more information.

Item Home Page Items

Once an item is selected, on the right-hand side, you will see the product name and manufacturer, the Newmar part number, as well as a photo from ComNet, Newmar's parts catalog (when available).

On the left-hand side, you will see a list of Special Notices (discontinued items, etc.), Features pertaining to the part or component, Newmar's Warranty Information, Manufacturer Site Links, and the chart of Relevant Coaches (model and year) that the part or component was installed in (standard or optional).

Within the Manufacturer Site Links section, you will have access to associated links to the direct manufacturer or supplier for the following information, when available:

- Operation, Installation, and Maintenance Manuals
- Care and Maintenance Guides
- Product Specifications & Reviews
- Safety Information & Warranty Registration Forms
- Troubleshooting Guides and Service Manuals
- Parts and Accessories Catalogs
- FAQ's & Videos
- Technical Guides (when available to the public)

What if I Can't Find What I Need?

Our dedicated, full-time Newgle staff is working to provide you with access to more model-specific information directly from the manufacturers as quickly as we can.

By leaving feedback and requests for specific information at the bottom of any page, you have the opportunity to directly impact how we prioritize our efforts!

Sony Blu-ray Players

Last updated: 09/27, 10 May 2017

¹"Sony's Blu-ray players offer a range of media, connectivity, and streaming media options."



IHP Items

- [Click BDP-S3200 :: Sony Streaming Blu-ray Disc Player with Super WiFi :: 126172](#)
- [Click BDP-S1500 :: Sony Wired Streaming Blu-ray Disc Player :: 131129](#)
- [Click BDP-S1700 :: Sony Blu-ray Disc Player :: 135190](#)

¹Material sourced from <http://www.sony.com/electronics/televisions-home-theater>

Sony Blu-ray Players

Last updated: 09/27, 10 May 2017

¹"Sony's Blu-ray players offer a range of media, connectivity, and streaming media options."



+ Table of contents

IHP Items

- [Click BDP-S3200 :: Sony Streaming Blu-ray Disc Player with Super WiFi :: 126172](#)
- [Click BDP-S1500 :: Sony Wired Streaming Blu-ray Disc Player :: 131129](#)

Special Notices

- This item replaces Newmar Part #126171.

Features

- 300+ streaming apps! Netflix, YouTube, Hulu Plus, Amazon Instant Video & more
- PlayStation Now: Stream and enjoy PlayStation 3 games
- Full HD 1080p Blu-ray Disc playback & DVD upscaling
- Easy access to apps and functions with a new and customizable User Interface
- Quick Start/Load to watch movies faster than ever

Warranty Information

- Newmar Warranty: One Year from the original owner's date of purchase.

Manufacturer Site Links

- [BDP-S1500 Landing Page](#)
- [Operating Instructions](#)
- [Simple Manual](#)
- [Marketing Specifications](#)
- [Sony Product Registration](#)
- [Sony Home Page](#)

Relevant Coaches

	Bay Star Class A	Canon Star Class A	Ventura LE Diesel Pusher	Ventura Diesel Pusher	DutchStar Diesel Pusher	Mountain Aire Diesel Pusher	London Aire Diesel Pusher	Essex Diesel Pusher	King Aire Diesel Bus
2015	X	X	X	X	X	X	X	X	
2016	X	X	X	X	X	X	X	X	X

All Search Terms help e1200; help e1200; help e1200; help e1200; help e1200

- [Click BDP-S1700 :: Sony Blu-ray Disc Player :: 135190](#)

Newmar Part # 131129
Sony Wired Streaming Blu-ray Disc
Player



Was this article helpful?



Leave feedback

How can we improve this article?

Yes, you may contact me about this feedback.

Submit feedback







NOTICE

All of the information in Newgle is believed to be accurate at the time of publication. However, it may be necessary to make revisions, and Newmar reserves the right to make any such changes without notice or obligation.

Safety Notices in Newgle

Reference is made to the following terms throughout Newgle and the Owner's Guide: Danger, Warning, Caution, Important, and Notice. These terms indicate important information that must be understood and followed.

 DANGER	DANGER indicates an imminently hazardous situation that, if not avoided, will result in death or serious injury. Failure to observe a DANGER may also result in damage to the equipment or unit.
 WARNING	WARNING indicates a potentially hazardous situation that, if not avoided, could result in death or serious injury. Failure to observe a WARNING may also result in damage to the equipment or unit.
 CAUTION	CAUTION indicates a potentially hazardous situation that, if not avoided, may result in minor or moderate injury. Failure to observe a CAUTION may also result in damage to the equipment or unit.
 IMPORTANT	IMPORTANT notices are not related to personal injury, but provide additional information to make a step easier or clearer.
 NOTICE	NOTICE indicates information that is not necessary or required, but may prove to be helpful.

Warranty and Service

“Customers say they’re loyal to us because they trust us to stand behind our products – from support, parts and service to paying our warranties. It feels good to own a coach that has all of that behind it.” The only warranty offered by Newmar Corporation is set forth in the written limited warranty that applies to this vehicle. The Newmar Corporation Limited Warranty was provided to you by your selling dealer prior to purchase.

 IMPORTANT	Warranty service required needs to be completed during the term of the warranty. Service work scheduled or performed after the expiration of the Newmar warranty will not be covered.
---	--

The limited warranties issued by the chassis and component manufacturers require periodic service and maintenance. The owner's failure to provide this service and/or maintenance may result in the loss of warranty coverage.

The owner should review the Newmar Corporation Limited Warranty and other manufacturers' limited warranties on all components applicable to this vehicle. To activate the warranties on the components within your Newmar recreational vehicle, be sure to file the appropriate registration card with the component manufacturer.

If, for any reason, you have a problem obtaining satisfactory and timely warranty service that may substantially impair the use, value, or safety of your Newmar coach, please call Newmar Customer Service toll free at (800)731-8300.

Customer Relations

If you wish to schedule maintenance work, schedule service work, or order parts you should notify your local authorized Newmar Service Center to set up an appointment. If you are unsure of the location of the closest authorized Service Center, contact Newmar Customer Service. You may also write to:

Newmar Corporation | Warranty Department | P.O. Box 30 | Nappanee, IN 46550

About Your Owner's Information Package

Included in your Owner's Information package are valuable documents about your vehicle and its components and systems. The Newmar Owner's Guide does not cover every possible detail of the equipment, standard and/or optional, installed on or in your vehicle. Consulting the booklets and instruction manuals in this package will help you safely operate, maintain, and troubleshoot these items.

Read all of the information and understand the safety and operating instructions included in the Owner's Information Package. To assure full warranty coverage, it is essential that all maintenance instructions are followed.

Information Sheet

An information sheet is provided containing important information about your coach for your convenience. Listed on this sheet is the following information:

THANK YOU FOR PURCHASING A QUALITY NEWMAR PRODUCT! FOR YOUR CONVIENCE, WE HAVE ENCLOSED A SERIAL NUMBER LIST OF IMPORTANT EQUIPMENT INSTALLED IN YOUR 2005XXXX###. THE SERIAL NUMBER FOR YOUR UNIT IS #####.

VIN# XXXXXXXXXXXXXXXX		DECOR# XX5-###	WOODCOLOR CHERRY					
CLIMATE SYSTEM		ENERGY MANAGEMENT SYSTEM		AWNING				
FRONT A/C	630515.321	33087	INVERTER	RV2012M	0062072	AWNING HDW	8150P21	96054
CENTER A/C	630515.321	33088	CONVERTER			AWNING HDW	8551001	551
REAR A/C			GENERATOR	042702	20570	DOOR	40368888	356
DASH A/C	RV200875	6534	AUDIO/VIDEO/NAVIGATION			WINDOW 1		
FRONT FURN.	SF42	06950	FRONT TV	24FV300	60575	WINDOW 2		
REAR FURN			REAR TV	20FS100	72234	WINDOW 3		
AUX.HEATER			TV #3			WINDOW 4		
APPLIANCES			EXT. TV	4361270		WINDOW 5		
WASH	WD2	1	FRONT	20F18C		WINDOW 6		
						TO TOPPE		

- Your coach's Newmar Serial Number. This number is needed whenever making an appointment for service or ordering parts through your Newmar Dealer or Service Center.
- Your coach's Vehicle Identification Number (VIN). The VIN is the legal identification of the completed vehicle and is used by the state for vehicle registration.
- Your coach's Year, Model, Type, and Floorplan
- Manufacturer, Model, and Serial Number of factory installed equipment.



IMPORTANT

The manufacturer, model, and serial number of the appliances and accessories installed at the factory in your unit are listed on this label for convenience. It is important that the label remain in the coach for identification purposes. Do not remove or relocate this label.

About the Delivery Process

Throughout the manufacturing process, your vehicle has been inspected by Newmar qualified technicians. However, our final inspection at the factory is not to be the last one. The pre-delivery inspection and systems check your dealer performs are the final inspections done to the unit prior to you receiving your new coach. Your dealer may assist you in understanding the limited warranties and with completing all warranty forms for the various appliances and accessories installed in your unit.

Customer Responsibilities

To assist you in avoiding problems with your vehicle, we recommend you do the following:

1. Read the warranty. Go over it thoroughly with your dealer.
2. Inspect the vehicle. Do not accept delivery until you have gone through the coach with the dealer. Newmar has provided a check list to be used during retail delivery. Check each item on the list, and make sure the dealer does the same. Do not sign this checklist until you have done checked off each item.

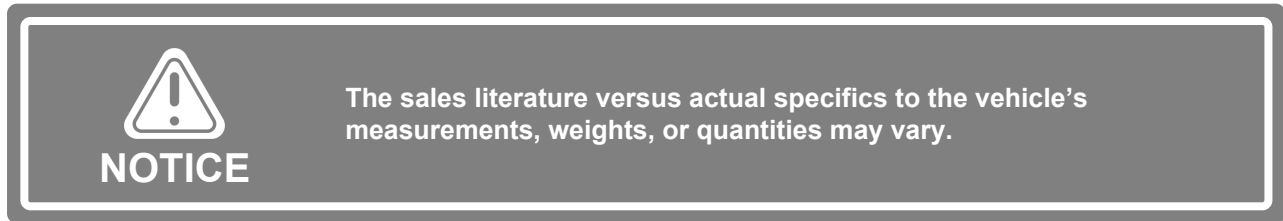

3. Ask questions about anything that you do not understand concerning your recreational vehicle.
4. Responsible Use. Your vehicle is designed to be used for recreational or temporary living purposes. It is not designed to be used as a full-time residence or for commercial use. Commercial use means using as a business asset, such as a mobile office or using the vehicle for lease/rental purposes.

Dealer Responsibilities

1. A pre-delivery inspection and systems check: thoroughly inspecting the vehicle and the operation of the factory installed components.
2. A customer walk-through to familiarize the customer with the vehicle, its systems and components, and their operation.
3. Delivery of the Owner's Information Package. This package contains the warranty cards and registrations for the vehicle and factory- installed components that carry a separate warranty. The detailed operating and maintenance instructions on these components are also included in this package.
4. Assisting the customer in completing the component registration forms, at the customer's request. To avoid loss of warranty coverage, the dealer should review the limited warranty provisions with the customer, stressing the importance of filing warranty cards and registrations to the component manufacturers within the prescribed time limit.
5. Providing the customer with information regarding warranty and non-warranty work on the vehicle, as well as its separately warranted components, whether the customer is in or out of the area.

Safety

Placards and Labels

A variety of placards and labels are located throughout your coach. These are installed to aid in the operation of a component, or to warn of potential dangers while operating a specific appliance, accessory, or system.

⚠ DANGER

All pilot lights, appliances and their igniters (see operating instructions) shall be turned off before refueling of motor fuel tanks and/or propane containers. Can cause ignition of flammable vapors, which can lead to a fire or explosion and result in death or serious injury.

⚠ WARNING

Do not fill propane container(s) to more than 80 percent of capacity. A properly filled container contains approximately 80 percent of its volume as liquid propane. Overfilling the propane container(s) can result in uncontrolled propane flow, which could lead to a fire or explosion and result in death or serious injury.

⚠ WARNING

This propane piping system is designed for use with propane only. Do not connect natural gas to this system. Securely cap inlet when not connected for use. After turning on propane, except after normal cylinder replacement, test propane piping and connections to appliances for leakage with soapy water or bubble solution. Do not use products that contain ammonia or chlorine to test for leaks. Can lead to a fire or explosion, which could result in death or serious injury.

DD-37

⚠ WARNING

Do not fill propane container(s) to more than 80 percent of capacity. A properly filled container contains approximately 80 percent of its volume as liquid propane. Overfilling the propane container(s) can result in uncontrolled propane flow, which could lead to a fire or explosion and result in death or serious injury.

⚠ WARNING

This propane piping system is designed for use with propane only. Do not connect natural gas to this system. Securely cap inlet when not connected for use. After turning on propane, except after normal cylinder replacement, test propane piping and connections to appliances for leakage with soapy water or bubble solution. Do not use products that contain ammonia or chlorine to test for leaks. May lead to a fire or explosion, which could result in death or serious injury.

⚠ AVERTISSEMENT

Ne pas remplir les bouteilles de propane à plus de 80 % de leur capacité. Une bouteille remplie de manière appropriée est remplie de propane liquide à environ 80 pour cent de son volume. Un remplissage excessif peut entraîner un écoulement incontrôlé du propane, ce qui pourrait provoquer un incendie ou une explosion et causer des blessures graves ou la mort.

⚠ AVERTISSEMENT

Cette tuyauterie de propane est conçue pour le propane uniquement. Ne pas raccorder de gaz naturel à cette tuyauterie. Obtenir l'orifice d'entrée lorsque le réservoir n'est pas utilisé. Une fois le robinet d'alimentation ouvert, sauf après un remplacement normal de la bouteille, vérifier l'étanchéité de la tuyauterie et des raccords avec une eau savonneuse ou autre solution faisant des bulles. Ne pas utiliser de produits contenant de l'ammoniac ou du chlore pour les essais d'étanchéité. Peut provoquer un incendie ou une explosion et causer des blessures graves ou la mort.

CO-251

These will include warnings regarding the electrical system, propane gas system, fueling the coach, and so on. It is important to read these placards and warnings to ensure the safety and proper operation of the item. An example of such labels are provided; one of these labels is affixed to your unit on or adjacent to your propane tank:

**IMPORTANT**

Reading, understanding, and heeding all such labels and placards is critical to the safe, efficient use of your coach.

Before Driving Away

**WARNING**

Prior to driving your vehicle, be sure you have read your entire owner's guide and that you understand your vehicle's equipment completely and safely. Read and understand all of the instructions and precautions in this owner's guide and the chassis manufacturer owner's manual before operating your new coach.

Listed below are some safety precautions that must be adhered to while your coach is in motion. These precautions, as well as others that involve possible damage to equipment, are also listed in the appropriate areas in this manual.

There are various adjustments that need to be made prior to starting and moving the vehicle. Among them are the driver's seat, the tilt steering, and the exterior side view mirrors, as well as checking the rear view monitoring system. In addition, the following procedures will aid in your driving safety and extend your equipment's life.

- Windows, mirrors, and light lenses are to be clean and unobstructed.
- Tires should be checked for proper cold inflation pressure.
- Wheel lug nuts should be checked for proper tightness.
- Fluid levels, including engine oil, transmission fluid, coolant, power steering fluid, brake fluid, and windshield washer solvent, should be checked and filled, if necessary.
- Disconnect the unit. Store the sewer and water supply hoses, as well as shoreline power cords.
- Secure all cargo in the storage compartments in the event of a sudden stop.
- Verify that the step has retracted prior to engine ignition.

Driving in Dangerous Conditions



WARNING

The cruise control is not to be operated on icy roads, extremely wet roads, winding roads, heavy traffic, or in any other traffic situation where a constant speed cannot be maintained.



WARNING

While driving on slippery surfaces, use care when accelerating or decelerating. Skidding and loss of vehicle control may be the result of abrupt changes in speed.



WARNING

Driving through water deep enough to wet the brakes may affect the stopping distance or cause the vehicle to pull to one side. If you have driven through deep water, check the brake operation in a safe area to be sure they have not been affected.



WARNING

Never operate a vehicle if a difference in braking efficiency is noticeable. Extreme terrain and adverse weather may affect the handling and/or performance of your vehicle.

Seat Belt Safety

One of the most important safety features in your vehicle is the restraint system. Research has shown that seat belts save lives. And they can reduce the seriousness of injuries in a collision. Some of the worst injuries happen when people are thrown from the vehicle. Everyone in a motor vehicle needs to be buckled up at all times.



IMPORTANT

These brief operation instructions are for quick reference only. Any quick start instructions provided should not take the place of the complete Operation Manual provided by this item's manufacturer.



WARNING

It is extremely dangerous to ride in a cargo area, inside or outside of a vehicle. In a collision, people riding in these areas are more likely to be seriously injured or killed. Do not allow people to ride in any area of your vehicle that is not equipped with seats and seat belts. Be sure everyone in your vehicle is in a seat and is using a seat belt properly.

How to Operate Your Seat Belts and Restraint System



WARNING

If you wear your safety belt improperly, both the effectiveness and comfort will decrease.

Operating Instructions for Lap/Shoulder Combination Restraints

1. Enter the vehicle and close the door. Sit back, and adjust the seat.
2. The latch plate of the belt is above the back of your seat. Grasp the latch plate, and pull out the belt. Slide the latch plate up the webbing as far as necessary to make the belt go around your lap.
3. When the belt is long enough to fit, insert the latch plate into the buckle until you hear a “click.”
4. Position the lap belt across your thigh, below your abdomen. If you need the lap portion tighter, pull up a bit on the shoulder part. A snug belt reduces the risk of sliding under the belt in a collision. Position the shoulder belt on your chest so that it is comfortable and not resting on your neck. The retractor will withdraw any slack in the belt.
5. To release the belt, push the release button on the buckle.



NOTICE

Some shoulder belts can be adjusted upward or downward to help position the belt away from your neck. Push on the anchorage cover to release it, and then move it up or down to the position that serves you best.

Operating Instructions for Lap Belt Restraints without a Shoulder Harness



WARNING

Always wear your seat belt when the vehicle is in operation.

1. Slide the latch up the webbing as far as necessary to make the belt go around your lap.
2. Insert the latch plate into the buckle until you hear a “click.”
3. Adjust and position the belt low and snug across your hips by removing the slack from the belt.
4. To release the belt, push the release button on the buckle.



IMPORTANT

Each belt is intended to restrain only one person at a time. Do not put two people under one belt.



CAUTION

Never attempt to restrain a child in your lap using the lap belt around both you and the child. The child could be severely injured or killed in the event of a collision.



IMPORTANT

Seat belts are matched sets. Do not mix or use this belt or parts of this belt with other types of seat belts.

Child Restraints



IMPORTANT

Everyone in your vehicle needs to be buckled up at all times. Every state in the United States and all Canadian provinces require that small children ride in proper restraint systems. This is the law, and you can be prosecuted for ignoring it.

There are different sizes and types of restraints for children from newborn to near-adult size children. Use the restraint that is correct for your child:

- The restraint must be appropriate for your child's weight and height. Check the label on the restraint for this, too.
- Carefully follow the instructions that come with the restraint. If you install the restraint improperly, it may not work when you need it.
- Buckle the child into the restraint exactly as the manufacturer's instructions have directed.

How to Maintain Your Seat Belts and Restraint System

Periodically examine your restraint equipment to be sure it functions correctly and to be sure there are no worn or broken components that either needs repair or replacement. Damaged parts must be replaced immediately. Do not disassemble or modify the system.

Restraint equipment must be replaced after an accident if they have been damaged. If there is any question regarding belt or retractor condition, replace the belt. It is a good idea to have your restraint system inspected during each periodic scheduled maintenance session.



WARNING

A frayed or torn belt could rip apart in a collision and leave you with no protection. Inspect the belt system periodically, checking for cuts, frays, or loose parts. Damaged parts must be replaced immediately. Do not disassemble or modify the system. Seat belt assemblies must be replaced after an accident if they have been damaged (bent retractor, torn webbing, etc.)

If the belts need cleaning, use a mild soap solution or lukewarm water. Do not remove the belts from the vehicle to wash them.



WARNING

Do not bleach, dye or clean the belts with chemical solvents or abrasive cleaners. This may severely weaken the fabric. In a crash, they might not be able to provide adequate protection.

Fire Safety



DANGER

If a fire occurs in the vehicle, evacuate the vehicle as quickly and as safely as possible. Consider the cause and the severity of the fire and the risk involved before trying to extinguish it. If the fire is major or fuel fed, move away from and stand clear of the vehicle and wait for emergency assistance to arrive.

DANGER

Vehicles and equipment powered by internal combustion engines and placed in recreational vehicles can cause carbon monoxide poisoning or asphyxiation, which could result in death or serious injury.

The flammable liquids used to power these items can cause a fire or explosion, which can result in death or serious injury.

To reduce risk:

1. Do not ride in the vehicle storage area when vehicles are present.
2. Do not sleep in the vehicle storage area when vehicles are present.
3. Close doors and windows in walls of separation (if installed) when any vehicle is present.
4. Run fuel out of engines of stored vehicles after shutting off fuel at the tank.
5. Do not store, transport, or dispense fuel inside this vehicle.
6. Open the windows, openings, or air ventilation systems provided for venting the transportation area when vehicles are present.
7. Do not operate propane appliances, pilot lights, or electrical equipment when motorized vehicles are present.

AD-98

The possibility of fire exists in all areas of life, and the recreational lifestyle is no exception. Recreational vehicles are complex machines made up of many materials, some of which are flammable.

Like most hazards, the possibility of fire can be minimized, if not totally eliminated by recognizing the danger and practicing common sense safety and maintenance habits. For safety reasons, your unit is furnished with both a fire extinguisher and a smoke alarm.

Fire Extinguishers

The fire extinguisher is rated for Class B (grease, gasoline, diesel fuel, flammable liquids) and Class C (electrical) fires. These are the most common types of fires in vehicles. Fire extinguishers are mechanical, pressurized devices. Care must be exercised when they are handled.

The extinguisher should be inspected at least once a month. More frequent inspections may be required if the extinguisher is exposed to the weather or to possible tampering. Do not test the extinguisher by partially discharging, as it will cause a loss of pressure. Your fire extinguisher must be maintained as the operator's manual instructs for proper and safe operation.

Read the operator's manual and the instructions on the fire extinguisher. Be sure to know how and when to use the extinguisher and where it is located.



DANGER

Failure to comply could result in an increased risk of fire, explosion, asphyxiation, serious injury, or death.

Smoke Detectors

WARNING

Test smoke alarm operation after vehicle has been in storage, before each trip, and at least once per week during use.

Failure to do so can result in death or serious injury.

AVERTISSEMENT

Vérifier l'avertisseur de fumée si le véhicule a été entreposé, avant chaque déplacement et au moins une fois par semaine en service.

L'absence de vérification peut entraîner des blessures graves ou la mort.

DD-94

The smoke detector installed in your coach is operated on a 9 volt battery. The smoke detector is mounted on the ceiling in the living area of the unit. Read the operating instructions for details on the testing and care for this important safety device.

Test the smoke detector after the unit has been in storage, before each trip, and at least once a week during use. Check your smoke detector for the manufacturer's expiration date. The battery needs to be tested periodically and replaced once a year and/or when the low battery signal sounds.

When cleaning the case on any of the detectors, use a damp cloth or paper towel. Do not spray cleaners or wax directly into the case as it may cause false alarms.



IMPORTANT

The detector should never be disabled because of nuisance or false alarm from cooking smoke or a dusty furnace. Ventilate the unit with fresh air and the alarm will shut off. Never disconnect or remove the battery from the smoke alarm.

Carbon Monoxide Safety



DANGER

Carbon monoxide is deadly. Read and understand the following precautions, as well as any warning labels in your coach, to protect yourself and others from the effects of carbon monoxide poisoning.

Carbon monoxide is a colorless, tasteless, odorless gas. It is a by-product of the burning of fossil fuels (gasoline, propane gas, diesel fuel, etc.). The chassis and generator engines, furnaces, water heater, propane gas refrigerator, and range produce carbon monoxide constantly while they are operating.

If you, or anyone else, experience any of the following carbon monoxide poisoning symptoms, exit the coach immediately. Seek medical attention if the symptoms persist. Shut down the coach, and do not operate it until it has been thoroughly inspected and repaired.

DANGER

Vehicles and equipment powered by internal combustion engines and placed in recreational vehicles can cause carbon monoxide poisoning or asphyxiation, which could result in death or serious injury.

The flammable liquids used to power these items can cause a fire or explosion, which can result in death or serious injury.

To reduce risk:

1. Do not ride in the vehicle storage area when vehicles are present.
2. Do not sleep in the vehicle storage area when vehicles are present.
3. Close doors and windows in walls of separation (if installed) when any vehicle is present.
4. Run fuel out of engines of stored vehicles after shutting off fuel at the tank.
5. Do not store, transport, or dispense fuel inside this vehicle.
6. Open the windows, openings, or air ventilation systems provided for venting the transportation area when vehicles are present.
7. Do not operate propane appliances, pilot lights, or electrical equipment when motorized vehicles are present.

AD-96

WARNING

Do not sleep in this area. Carbon monoxide or other harmful vapors could enter the area through the floor openings, which could result in death or serious injury.

AVERTISSEMENT

Ne pas dormir dans cette aire. Du monoxyde de carbone ou d'autres vapeurs nocives pourraient y pénétrer par des ouvertures dans le plancher et entraîner des blessures graves ou la mort.

AD-98F

- Dizziness
- Nausea
- Vomiting
- Muscular twitching
- Throbbing in the temples
- Inability to think coherently
- Weakness and/or sleepiness
- Intense headaches



WARNING

Do not block the tailpipes or exhaust ports. Do not situate the vehicle in a place where the exhaust gases have any possibility of accumulating either outside, underneath, or inside your vehicle or any nearby vehicles. Outside air movements can carry exhaust gases inside the vehicle through windows or other openings remote from the exhaust outlet. Operate engines, carbon monoxide-producing systems, or components only when safe dispersion of exhaust gases can be assured. Monitor outside conditions to be sure that exhaust continues to be dispersed safely.

Carbon Monoxide (CO) Detectors

The detector is equipped with a "sensor activation strip," which must be removed for the detector to operate properly. This should have been done during the dealer's Pre-Delivery Inspection. Please check the detector to verify that the activation strip has been removed. Please consult your carbon monoxide detector Owner's Manual for more detailed information.

The CO detectors are self-contained and do not require any maintenance other than normal cleaning and dusting.



WARNING

Under no circumstance should you operate any engine while sleeping. When you are sleeping, you are not able to monitor outside conditions to assure that engine exhaust does not enter into the coach. Check the exhaust system frequently for damage. If damage is found, do not operate the system. Never modify the exhaust system(s) in any way.

LP Safety

Propane gas is extremely flammable. The propane detector in your coach is located in the main living area close to the floor. It is wired to the 12 volt electrical system in your unit.



DANGER

Read and understand the following precautions, as well as any warning labels in your coach, to protect yourself and others from the risks of operating an LP system.

Your coach may be equipped with an ASME (American Society of Mechanical Engineers) approved propane tank. This tank is controlled with an automatic pressure regulator. The propane tank contains liquid petroleum gas under high pressure. As the fuel is used, the liquid gas vaporizes and passes through the tank valve to a regulator that automatically reduces the pressure. The low-pressure gas is then distributed to the appliances throughout the pipe manifold system.



WARNING

The primary gas supply manifold is a black steel pipe running the length of the unit. Most secondary lines leading to the gas appliances are made of copper tubing with flare fittings. If any of these lines rupture, do not attempt to splice them. Always run a new line. Gas distribution work must be performed by an authorized service technician. When removing or servicing any gas appliance, close the main gas valve on the propane tank to prevent dangerous gas leakage that could result in an explosion and possible serious injury.



WARNING

Propane gas containers, gasoline or other flammable liquids shall not be placed or stored inside the vehicle. Propane cylinders are equipped with safety devices that relieve excessive pressure by discharging propane to the atmosphere. Failure to comply could result in serious injury or death.



DANGER

Exhaust gases contain carbon monoxide (an odorless, colorless, and poisonous gas). These gases are produced by burned gasoline, diesel, or propane gas. Items such as the range, furnace, water heater, refrigerator, chassis engine, or generator engine can produce these gases. These fumes should not be inhaled.



WARNING

Portable fuel-burning equipment, including wood and charcoal grills and stoves, shall not be used inside the recreational vehicle, as they can cause fire or asphyxiation. Failure to comply could result in serious injury or death.

If You Suspect a Gas Leak

DANGER	
<p>IF YOU SMELL PROPANE</p> <ol style="list-style-type: none"> 1. Extinguish any open flames and all smoking materials. 2. Shut off the propane supply at the container valve(s) or propane supply connection. 3. Do not touch electrical switches. 4. Open doors and other ventilating openings. 5. Leave the area until the odor clears. 6. Have the propane system checked and leakage source corrected before using again. <p><small>IGNITION OF FLAMMABLE VAPORS COULD LEAD TO A FIRE OR EXPLOSION AND RESULT IN DEATH OR SERIOUS INJURY.</small></p>	<p>SI VOUS SENTEZ UNE ODEUR DE PROPANE :</p> <ol style="list-style-type: none"> 1. Éteignez toute flamme nue et tout article pour fumeur. 2. Coupez l'alimentation en gaz de l'appareil au réservoir ou au raccordement d'alimentation. 3. Ne touchez pas aux interrupteurs électriques. 4. Ouvrez les portes et toute autre ouverture de ventilation. 5. Quittez les lieux jusqu'à ce que l'odeur ait disparu. 6. Faites vérifier l'installation et colmater toute fuite avant d'utiliser de nouveau. <p><small>L'INFLAMMATION DES VAPEURS INFLAMMABLES POURRAIT PROVOCUER UN INCENDIE OU UNE EXPLOSION ET ENTRAÎNER DES BLESSURES GRAVES OU LA MORT.</small></p>

In the event the detector alarms while in use, or if you smell propane or suspect a gas leak (the odor smells similar to rotten eggs or sulfur), follow the warning labels posted in your coach.

- Immediately turn off all potential sources of ignition (furnace, water heater, refrigerator, stove/range, etc.), and extinguish any open flames, pilot lights, and all smoking materials.
- Consult an authorized service technician for repairs, as the propane system must be checked, and the leakage source must be corrected before using the propane system again.



WARNING

Failure to comply could result in fire or explosion.

⚠ WARNING

Do not fill propane container(s) to more than 80 percent of capacity. A properly filled container contains approximately 80 percent of its volume as liquid propane. Overfilling the propane container(s) can result in uncontrolled propane flow, which could lead to a fire or explosion and result in death or serious injury.

⚠ WARNING

This propane piping system is designed for use with propane only. Do not connect natural gas to this system. Securely cap inlet when not connected for use. After turning on propane, except after normal cylinder replacement, test propane piping and connections to appliances for leakage with soapy water or bubble solution. Do not use products that contain ammonia or chlorine to test for leaks. May lead to a fire or explosion, which could result in death or serious injury.

⚠ AVERTISSEMENT

Ne pas remplir les bouteilles de propane à plus de 80 % de leur capacité. Une bouteille remplie de manière appropriée est remplie de propane liquide à environ 80 pour cent de son volume. Un remplissage excessif peut entraîner un écoulement incontrôlé du propane, ce qui pourrait provoquer un incendie ou une explosion et causer des blessures graves ou la mort.

⚠ AVERTISSEMENT

Cette tuyauterie de propane est conçue pour le propane uniquement. Ne pas raccorder de gaz naturel à cette tuyauterie. Obtenir l'orifice d'entrée lorsque le réservoir n'est pas utilisé. Une fois le robinet d'alimentation ouvert, sauf après un remplacement normal de la bouteille, vérifier l'étanchéité de la tuyauterie et des raccords avec une eau savonneuse ou autre solution faisant des bulles. Ne pas utiliser de produits contenant de l'ammoniac ou du chlore pour les essais d'étanchéité. Peut provoquer un incendie ou une explosion et causer des blessures graves ou la mort.

CO-251

Propane (LP) Detector

Operating instructions and a test button are located on the face of the detector. The propane detector should be tested after the vehicle has been in storage, before each trip, and at least once per week during use.

Never attempt to repair the propane detector. Do not remove the fuse or disconnect wiring to the propane detector. If the propane detector will not function, check for 12 volt power at the detector. If an issue is found, or if the 12 volt electric circuit is found to be operational, repair or replace the propane detector.



WARNING

Do not use coach with a non-operational or disabled LP detector.



IMPORTANT

Never spray any type of aerosol or cleaner directly onto or into the propane detector. Spraying any type of material into the opening on any of these detectors can render them useless, and would not be covered by the manufacturer's warranty.



WARNING

Never test for a leak by lighting a match or having an open flame where you suspect leaking gas.

Filling Your Propane System



While refilling the fuel or propane tank, the engine must be off, all pilot lights must be extinguished, and appliances turned off. The vehicle should be as level as possible, and the service valve should be turned off. Smoking is also prohibited at this time.



Shut off the propane gas valve when refueling to avoid potential danger from pilot lights igniting fuel fumes. Some appliances, such as the refrigerator, water heater, and furnace, have DSI (direct spark ignition) boards, so it is important that you turn the appliances off when the propane gas is turned off. The ignition in the appliances may continue to spark even if there is no propane gas available.



Inspect the propane fill valve for foreign materials before refueling. Introducing foreign material into the fill valve may cause leaking or overfilling, resulting in uncontrolled gas flow and a fire or explosion.



All protective covers and caps must be replaced after filling the propane system. Once the valve is closed, securely latch the propane door.

Storing Your Coach with an LP System

Keep the tank valve closed and all of the appliances turned off when the unit is stored. If any of the Propane gas valves do not close leak-tight by hand, consult a service technician.

On older coaches, an LP switch may be located in the front overhead or toward the bottom of the passenger chair. This switch shuts off power to the propane detector to prevent an unnecessary draw from the battery bank while the coach is in storage. Newer coaches are wired to the disconnect side of the battery disconnect solenoid to prevent the detector from draining the battery while the coach is in storage with the disconnect turned off.

Keep this switch turned on when the coach is in use for the capability of detecting a leak in the propane system.



Shut off the main gas valve at the tank when the vehicle is not in use.

Safety Compliance

Newmar motorhomes meet or exceed compliance for the following agencies:

Canada

- Canada Motor Vehicle Safety Standards (CMVSS)
- Federal Motor Carrier Safety Administration (CSA Z 240)
- Canadian Electrical Code through QAI Laboratories

United States

- Federal Motor Vehicle Safety Standards (FMVSS)
- Oregon, Nebraska, and Washington State Seals
- National Fire Protection Association (NFPA) 1192 through Recreation Vehicle Industry Association (RVIA)
- National Fire Protection Association (NFPA) 70 National Electrical Code
- Ford Qualified Vehicle Modifiers (QVM) (Ford Chassis Only)
- Carb Compliant Phase 2



IMPORTANT

If you believe that your vehicle has a significant defect which could cause a crash or could cause injury or death, inform the National Highway Traffic Safety Administration (NHTSA) and Newmar Corporation immediately.

To contact NHTSA, call, write, or visit them on the web.

Phone: Auto Safety Hotline (toll free) at 1-888-327-4236 (TTY #1-800-424-9153)

Write: NHTSA, 400 Seventh Street S.W., Washington, DC 20590

Website: <http://www.safercar.gov>.

For More Information

Refer to the product manufacturer's owner's manual and links to learn more about your coach's detectors, fire extinguishers, and seat belts.

Care and Maintenance

Recreational vehicles are complex machines and require maintenance to maintain both the appearance and functionality of the coach. General maintenance, inspection of components and seals, fluid changes, and many other maintenance items will help retain your coach's dependability, safety, visual appearance, and resale value.



IMPORTANT

Read and follow all maintenance schedules to meet warranty requirements. Preventive maintenance and scheduled maintenance items are not warrantable. Damage caused by improper or unapplied maintenance is not covered by your Newmar Limited Warranty.

How to Wash and Dry a Coach



IMPORTANT

Damage caused by improper or unapplied maintenance is not covered by your Newmar Limited Warranty.

Washing an RV

The clear coat used on all painted portions of the exterior is a similar to the technology that used by car manufacturers. The same care needs to be performed and maintained on your coach exterior surface as on your automobile. Following these procedures can provide a long-lasting, high-gloss finish on your coach.

1. Make sure the coach's surface temperature is under 90° F. Never wash the vehicle in direct sunlight, while the vehicle is hot, or with hot water.
2. Rinse the entire coach to remove all loose dirt and grime. Never hold a pressure washer close to the surface. Use a fan-type spray nozzle, making sure that the water is not a single straight stream. Keep the stream at least 18 inches from the edge of any decals, as high pressure water may cause the decals to loosen and peel.
3. Most car stores offer mild car wash shampoos that are safe for clear coat finishes. You may also use baby shampoo to prevent leaving a film on the coach. Adding ½ of a cup of food grade vinegar to three gallons of water will boost the cleaning ability and will also soften the water to help minimize water spots. Rinse thoroughly to prevent soap residue accumulation.



IMPORTANT

Do not use dish soap, detergents with degreasing agents, or industrial cleaners, as they can cause damage to the finish on your coach.



IMPORTANT

Do not use solvents such as acetone, MEK, toluene, etc. on the decals. Any solvent including alcohol may soften or smear colors. Do not use lacquer thinner or paint on decals. Do not overcoat the decals with clear paint. Do not allow gasoline or other fuels to drip or stay on the decals for any length of time. If this occurs, immediately flush the area with water.

4. Use 100% cotton or Lambswool pads or wash mitts for washing the painted surfaces of your coach. Use a different mitt for washing the wheels and undercarriage.

The following products may assist you when cleaning your coach, and may be purchased through the Newmar parts department:

- Lambswool Pad (Newmar part #018461)
- Backer Pad (Newmar part #018461A)
- Lambswool Mitt (Newmar part #018464)
- Extension Pole (Newmar part #018463)

5. Change the water in your wash bucket often, or place a "dirt guard" in bottom of the bucket to keep the cleaning pad or wash mitt free of dirt and debris.



IMPORTANT

Absolutely no brushes should be used on the painted surface of your coach, as it will cause damage to the finish, just as it would an automobile finish. Newmar does not support the use of any style, type, or brush material, even though it may be marketed as 'RV Safe' or 'Approved.'

Drying an RV

Drying your RV is just as important as washing it. Tap water and well water contain many chemicals that could water stain your coach's finish. After washing, dry your coach with the EZE Squeegee (Newmar part #018462) or a clean 100% leather chamois. You can also use fresh microfiber towels for drying. Please use caution, as these towels are made partially with polyester (plastic), which can break down over time from extended use and washing, eventually causing damage to the clear coat finish.

Maintaining Your Diamond Shield Paint Protection

For information on how to maintain your Diamond Shield Paint Protector, refer to the "Paint, Roof, and Siding" sub-category under the Exterior Category.

Waxing and Polishing a Coach

The coating on your coach is a state-of-the-art base coat and Urethane clear coat. The clear coating is designed to protect the colored base coat, so it needs to be maintained, especially in harsh environments. Clear coats will appear to fade or lose gloss as the surface becomes contaminated by the environment. A finish that is dull or low in gloss is a result of contamination. Occasional washing alone will not adequately remove some forms of contamination and will require polishing of the finish.

The exterior finish of your coach will require a routine waxing. When water will not bead and roll off a freshly washed vehicle, a new coat of wax is needed. Wax not only improves the appearance of the vehicle, but it also protects the finish against oxidation and corrosive materials. The recommended type of wax is one that is compatible with painted or gel-coated fiberglass finishes, and contains a UV (ultra-violet) inhibitor. Buffing with a polishing compound will improve a dull or discolored finish.



IMPORTANT

When using a polishing compound that does not contain a wax preservative, reapplying a coat of hard wax after polishing is recommended.



IMPORTANT

Do not use products that contain harsh abrasives such as rubbing compounds, as these products should only be used by an experienced technician with proper training and equipment.

Benefits of Waxing and Polishing

- Remove minor surface imperfections caused by water spots and acid rain
- Remove minor scratches by filling them and leveling the surface
- Seal the pores of the finish, creating an easier-to-clean surface

- Beautify the paint finish appearance with more depth and high gloss
- Protect the paint finish from the elements

Most polishes and waxes are designed to clean and polish in one application, whether by hand or machine. A machine-applied polish will last longer than one applied by hand, as the high RPMs of the buffing wheel create heat, resulting in a deeper film with higher gloss. However, a hand-applied polish or wax will offer outstanding performance and protect the coach's finish.

Due to the variations of polishes and waxes, incorporate the following:

- Apply polish or wax while the coach is parked in a shaded area so the coach's surface is at the specified temperature according to the polish manufacturer's recommendations.
- Condition the polishing pad by rubbing a slight amount of polish on it.
- Use only the amount of polish specified in the label directions.
- Work a small area at a time.
- Rinse off and remove dried polish from crevices, trim, and moldings.



Refrain from waxing or polishing for at least 90 days from the coach's date of manufacture.

IMPORTANT

How to Winterize a Coach

When to Winterize a Coach

Although great care has been taken to build a well-insulated unit, recreational vehicles are not intended for extended use in sub-freezing weather without special precautions. When the outside temperature drops below freezing, the furnace must be turned on to keep the coach warm. Continued use in cold weather will require the coach to be winterized.

It is critical to winterize the plumbing in your coach when storing it in temperatures below freezing or using it in extremely cold conditions. If subjected to these conditions without being properly winterized, the heating system may be unable to keep the coach and its compartments above freezing temperatures.



Winterizing is the responsibility of the consumer. Make sure you have protected the complete water system any time your coach is in freezing temperatures. Failure to complete the winterization process may result in extensive damage to the water system, appliances, and coach.

WARNING



A regulated compressed air supply is needed to properly complete this procedure. The pressure should be regulated between 40 and 60 PSI (pounds per square inch). Higher pressures may cause damage.

IMPORTANT

Water Compartment Examples



The following images are for example purposes only. Your coach may or may not be equipped with the same components as shown.

IMPORTANT



Example of a Water Compartment on a Gas Coach



Example of a Water Compartment on a Luxury Coach

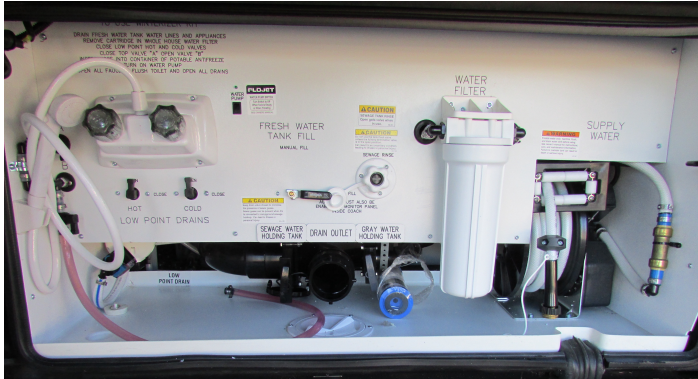

Example of a Water Compartment on a Diesel Coach

How to Winterize a Coach

1. Drain the black and grey tanks. If equipped, also empty the macerator hose.
2. Drain the Fresh Water Tank. Open the tank drain valve located in the driver side water bay.
3. Turn off the switch(es) to the water heater or the hydronic heating system, including the burner and the 120 Volt element, depending on your coach's equipment.
4. Turn on the refrigerator.
5. While the tank is draining, remove all of the water filters. Install a bypass or the filter canister, including the whole house, refrigerator, and drink water filters (whether standard or UV), if your coach is equipped.
6. For units with a tank-style water heater instead of a hydronic heater, close the valves to the water heater. Open the bypass valve, which is normally located at the back side of the water heater. Depending on your particular floor plan, access to back of water heater may be located in the closet or exterior bay.



NOTICE

For units with a tankless water heater, do NOT put the water heater in by-pass mode. Instead, blow it out, and install the antifreeze as directed for a hydronic heater.

7. Remove the drain plug at the bottom of the water heater tank on the exterior of the coach.



IMPORTANT

The 120 Volt water heater element must be turned off by flipping the switch near the water heater's drain plug.

8. Open the low point drains by turning the valve to the "open" position or by pulling up on the handle if the coach is equipped with T-Handle valves. There should be one drain for hot and one for cold, and they are normally located in the water compartment.

9. Connect the regulated air supply to the inlet of the hose from the hose reel (if equipped) or the city water fill inlet. Air will flow out of the low point drains.
10. Cycle the auto fill or tank fill valve (whichever the coach is equipped with) to all possible positions for a minimum of 10 seconds at each position.
11. Close the low point drains. This must be done prior to pumping antifreeze through the lines, or the antifreeze will be pumped onto the ground.
12. Remove the whole house filter canister, and dump any remaining water, and reinstall.
13. Locate the winterizing valves marked "A" & "B" located in the water compartment.
14. Close valve "A" by rotating the valve clockwise. Open valve "B" by rotating the valve counter clockwise.
15. Remove the plug at the end of the clear winterizing hose.
16. Insert the hose into a jug or bucket of antifreeze.
17. Replace the empty jugs, or refill the bucket as needed to complete the entire process.
18. Turn on the water pump by activating water pump switch. Red antifreeze will start flowing through the clear hose into the water lines.
19. Run cold water from the kitchen faucet until the red potable antifreeze is detected. Run hot water from the kitchen faucet until the antifreeze is detected.



IMPORTANT

Make sure you run enough antifreeze through each faucet to fill each P-trap.

20. Proceed to the next faucet, and repeat process for each faucet, including the lavatory, shower sprayers and outside shower faucet. If equipped, repeat the press for the instant hot water and drinking water dispensers.



IMPORTANT

For coaches equipped with a sink or shower connected to a Santivite lift pump, the lift pump must be completely emptied, or enough RV antifreeze must be poured down the drains to allow the pump to cycle until the antifreeze concentration is sufficient for freeze protection.

21. Flush each toilet until the red antifreeze is detected. If the toilet is equipped with a sprayer, activate and flush it until the antifreeze flows from the sprayer.
22. Run the dishwasher through a cycle to winterize the water inlet plumbing, as well as the pump and drain line.
23. If the coach is equipped, turn on the washing machine. Select a wash cycle setting that uses warm water to activate both the hot and cold inlet valves. Allow the washing machine to fill for approximately two minutes. Press the "cancel" and "drain" selection to begin draining the machine. This will winterize the pump and drain, as well as the washing machine's P-trap.
24. Depress the refrigerator's external water dispenser while holding a container to catch the fluid. Continue to let the fluid flow until the red antifreeze is detected.



NOTICE

The red antifreeze may not appear instantly, as most refrigerators have a reserve for cold water. However, if you did not remove the water filter in the refrigerator in Step 5, the fluid will run clear for a long time.

25. Make sure the ice maker is turned on. Once it reaches the proper temperature, it will attempt to make ice cubes, which will become pink in color. This may take several hours. Once they become pink, turn off the ice maker and the refrigerator. Empty the ice cube tray, and clean out the ice maker and freezer area.
26. Turn off the water pump. Close the winterizing valve "B", and open valve "A".
27. Insert the plug into the clear hose, and stow the winterizing hose.
28. If the coach is equipped, winterize the macerator by turning it on and emptying the black and gray holding tanks, allowing the macerator and macerator hose to fill with antifreeze. If there is no macerator in the coach, use the sewer hose to drain the black tank, followed by the gray tank.

How to De-Winterize a Coach

1. Connect your water hose to a fresh potable water supply.
2. Set the auto fill or tank fill valve for city water supply.
3. Run water through each faucet, toilet, and shower on both hot and cold settings.
4. Run the dishwasher and the washing machine through a complete cycle before using.
5. Depress the refrigerator water dispenser while holding a container to catch the fluid being dispensed. Continue until clear water is dispensed.
6. Install the refrigerator filter (if equipped).
7. Turn off the water supply drain pressure from the system using low point drains. Install all filters in the system.



NOTICE

Newmar recommends installing clean filters unless the sanitization process will also be completed at this time.

8. Close the low point drains.
9. Turn on the ice maker, allowing it to run through multiple cycles. Throw away any ice with antifreeze. Clean out the ice maker and the tray until clear ice is available.
10. If the coach is equipped with a water heater, install a drain plug. Open the water heater valves, and close the by-pass valve on the back side of the water heater.
11. Turn on the fresh potable water supply.
12. Open the hot water faucet until the water heater is filled and flows through the faucet without air.
13. Flip the water heater switch to the "ON" position. This is located near the drain plug (if equipped with a water heater).
14. Check the tank level, and dump if necessary.
15. The coach is now ready to use.

How to Sanitize the Complete Water System

When to Sanitize the Water System

Newmar recommends sanitizing your water system under the following scenarios:

- Purchasing a new or used coach
- After your coach has been in storage for a lengthy amount of time
- If an unpleasant odor arises from your water
- At least once per year for proper maintenance

How to Sanitize the System

1. Drain the fresh water tank by turning the tank drain valve to the open position.
2. Drain the water heater (if equipped) by removing the drain plug.



WARNING

Do not attempt to drain the water heater when the water is hot or the system is pressurized, as scalding may occur.

While the tank is draining, remove all of the water filters, including the refrigerator and drinking water filters (standard or UV), if your coach is equipped, and install a bypass.



NOTICE

Not all filters have a 'bypass,' so it may be necessary to install the canister without the filter.

3. Remove the main (whole house) filter housing.
4. Remove the filter, and pour household bleach (1/4 cup per 15 gallons, as determined by your tank capacity) into the filter housing. For example: 1.75 cups of bleach for coaches equipped with a 105 gallon fresh water tank or 1.25 cups of bleach for coaches equipped with a 75 gallon fresh water tank.



NOTICE

This will approximately be a 50 ppm (parts per million) bleach solution.

6. Reinstall the housing and the water heater drain plug after it has drained completely.
7. Hook up the water hose from the hose reel (if equipped), or hook up a drinking water-safe portable hose to a potable water source.
8. Turn the valve to 'tank fill' or 'manual tank fill.'
9. Turn on the potable water source, and completely fill the water tank. (This will flush the bleach/water solution from the filter housing [Step 4] into the water tanks.)
10. Turn off the tank fill valve (on non-auto fill coaches).
11. Turn on the water pump.
12. Run water out of one faucet on both hot and cold settings until a strong bleach smell becomes evident.
13. Repeat this for all faucets, as well as the refrigerator, dishwasher, washing machine, toilets, low point drains, etc.



IMPORTANT

Top off the water tank so that the sides and top of the tank are sanitized as well.

14. Turn on the refrigerator and the ice maker. Depending on your refrigerator model, the ice maker may have a flip lever or an ON/OFF switch. Let the ice maker run until the bleach/water solution is detected. This may take a few cycles. One cycle consists of the ice maker filling the trays with water, freezing the water, and then dumping the ice into the ice bin. This cycling process will occur automatically if the refrigerator, the ice maker, and the water pump are all turned on.
15. Disconnect the water hose, and dump out some water.
16. Pour one ounce (1 oz.) of bleach into the water hose, and reconnect it to the potable water supply.
17. Turn on the water for a brief moment to flush the bleach through the water hose, allowing it to mix in the hose reel or the portable hose used for potable water.
18. Turn off the water supply, and disconnect the water hose.
19. Cap the end of the hose.
20. Let the bleach water sit in the system for a minimum of four hours. However, for best results, allow the solution to sit overnight or up to 12 hours.
21. Drain the fresh tank using the drain valve.
22. Fill the fresh tank with clean potable water.
23. Run water out of each faucet on both hot and cold settings until the bleach smell is no longer evident.



NOTICE

If the bleach smell is still noticeable, repeat steps 21-23 to flush the system again.



IMPORTANT

If algae or slime is detected in the fresh water system, it may be necessary to repeat the entire process until the system is flushed clean.

Once the system is flushed, Newmar recommends replacing the water filters. Do not re-use the contaminated filters, as this will greatly reduce the effectiveness of the sanitization process.



IMPORTANT

Sanitizing through the winterization process will not sanitize the fresh tank or all of the water lines.

How to Care for and Maintain the Dash

In order to keep the dash in like-new condition, follow these guidelines:

Do—

- Dust and clean the dash with a soft, damp cloth, or chamois, wiping the surface gently.
- Use a mild detergent and lukewarm water.
- Dry the surface, after washing and rinsing, by blotting with a damp cloth or chamois.

Do Not—

- Use harsh chemicals that may damage the dash.
- Use cloths containing grit or abrasive particles or kitchen scouring compounds to clean or dust the dash.
- Subject the dash to hard, direct blows.
- Use boiling water or strong solvents to clean the dash, as they will soften the plastic.

How to Care for and Maintain Exterior Chrome Accessories

1. Wash chrome items with soap and water the same way you wash the exterior paint.
2. If the chrome still has some tarnish and water spots on it, clean with a soft cloth and vinegar. Add a little baking soda to the rag if you need a stronger cleaner.
3. To clean rust off of the chrome, use a piece of crinkled aluminum foil dipped in vinegar. Scrub it with light to medium pressure, while making sure the the foil stays wet with vinegar. In instances of rust and/or corrosion, you may use a very fine steel wool, but should be a last effort. Test it in an inconspicuous area to ensure no damage is occurring while using the steel wool.
4. Rinse the area with clean water after using any cleaning products.
5. Once the chrome is nice, bright, and shiny, dry it completely with a soft cloth.
6. Apply a coat of wax and buff it. Apply a second coat of wax, and buff it again.



IMPORTANT

Remember the more often the chrome is cleaned and maintained, the easier the cleaning process. Coaches exposed to salt spray from the road or ocean air will need to be cleaned and waxed more often to maintain the best appearance.

How to Weigh a Coach

Below are some samples of the weight information labels that may appear in your coach.

MANUFACTURED BY / FABRIQUE PAR:		DATE:	
GVWR/PMBV	KG (LB)		
GAWR/PMBE	KG (LB)	TIRES/PNEU	RIMS/JANTE
FRONT/ AVANT	KG (LB)		COLD INFL. PRESS./PRESS. DE GONFL. A FROID
INTERM/ INTERM	KG (LB)		KPA SINGLE DUAL
REAR/ ARRIERE	KG (LB)		PSV(LPC) <input type="checkbox"/> <input type="checkbox"/>
			KPA SINGLE DUAL
			PSV(LPC) <input type="checkbox"/> <input type="checkbox"/>
			KPA SINGLE DUAL
			PSV(LPC) <input type="checkbox"/> <input type="checkbox"/>

THIS VEHICLE CONFORMS TO ALL APPLICABLE U.S. FEDERAL MOTOR VEHICLE SAFETY STANDARDS IN EFFECT ON THE DATE OF MANUFACTURE SHOWN ABOVE.
 THIS VEHICLE CONFORMS TO ALL APPLICABLE STANDARDS PRESCRIBED UNDER THE CANADIAN MOTOR VEHICLE SAFETY REGULATIONS IN EFFECT ON THE DATE OF MANUFACTURE. - CE VEHICULE EST CONFORME A TOUTES LES NORMES QUI LUI SONT APPLICABLES EN VERTU DU REGLEMENT SUR LA SECURITE DES VEHICULES AUTOMOBILES DU CANADA EN VIGUEUR A LA DATE DE SA FABRICATION.
 V.I.N./N.I.V.: TYPE/TYPE:

MOTOR HOME OCCUPANT AND CARGO CARRYING CAPACITY
 VIN: #####
THE COMBINED WEIGHT OF OCCUPANTS AND CARGO SHOULD NEVER EXCEED:
XXX kg or XXX lbs
 Safety belt equipped seating capacity: XXX
CAUTION:
 A full load of water equals XXX kg or XXX lbs of cargo @ 1 kg/L (8.3 lb/gal) and the tongue weight of a towed trailer counts as cargo

Figure 1 - Motor Home Occupant and Cargo Carrying Capacity Label

Weight Descriptions

The following definitions are provided to help with communication issues with weight and your coach.

The sales literature may give approximates or standards. Each individual unit may weigh differently based on the factory and/or dealer options added.

IMPORTANT

Gross Axle Weight Rating (GAWR)

The maximum permissible weight for an axle.

Gross Combination Weight Rating (GCWR)

The value specified by the manufacturer of the vehicle as the maximum allowable loaded weight of the motorhome and any towed trailer or towed vehicle.

Gross Vehicle Weight Rating (GVWR)

The maximum permissible weight of the fully-loaded motorhome. The GVWR is equal to or greater than the sum of the UVW plus the CCC.

$$GVWR \geq UVW + CCC$$

Unloaded Vehicle Weight (UVW)

The weight of this motorhome as built at the factory with full fuel, engine oil, and coolants. The UVW does not include cargo, fresh water, propane gas, or dealer-installed accessories.

Cargo Carrying Capacity (CCC)

The weight equal to GVWR, minus each of the following: UVW, full fresh (potable) water weight (including water heater), full propane gas weight, and SCWR.

$$CCC = GVWR - UVW - \text{Water Weight} - \text{Propane Weight} - \text{SCWR}$$

Gross Vehicle Weight (GVW)

The weight of the unit with all items and supplies that are loaded into the unit at any point in time.

Sleeping Capacity Weight Rating (SCWR)

The manufacturer's designated number of sleeping positions multiplied by 154 pounds (70 kilograms).

To assure the accuracy of your weights, make sure the unit is always level during weighing.

IMPORTANT

Weighing a Coach

The unit has been built to comply with the component suppliers' recommended limits to provide you with a realistic CCC. When loading the unit, distribute the items so that not all of the weight is added to one area of the unit.

If you have questions as to what the weight of the unit is after it has been loaded, take the unit to a drive-on scale or use individual wheel scales, and verify that the weights are within the limits of those specified for the unit. When weighing the unit, follow these instructions. Failure to follow these instructions may give an erroneous weight reading.

Step One

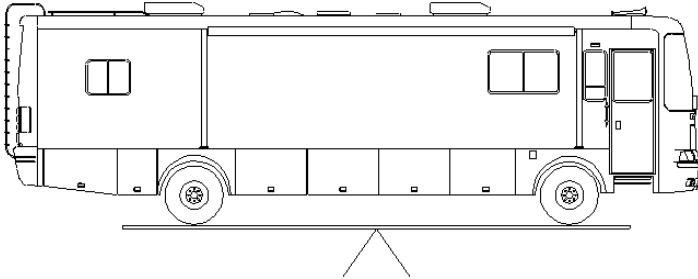

To find the total weight of the unit, pull the unit onto the scales so that all of the wheels are on the scale as shown. Record the weight. This is the GVW and should not exceed the GVWR supplied by Newmar for the unit.

Step Two

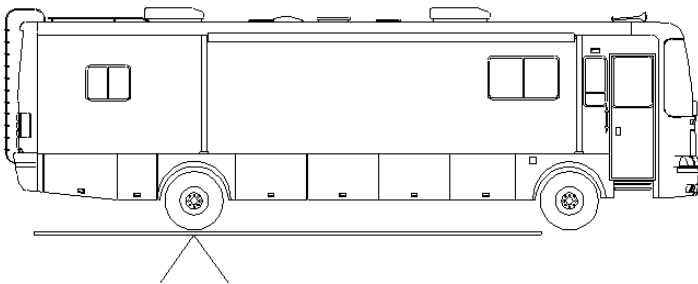

To find the total weight of the coach, except for the front axle, move the unit so that the front wheels are off the scales as shown. Record the weight. This weight should not exceed the total rating of the axles remaining on the scales. The front axle weight is determined by subtracting this weight from the GVW that was obtained in step one. This amount should not exceed the listed front axle weight rating.

Alternate Weighing Procedure

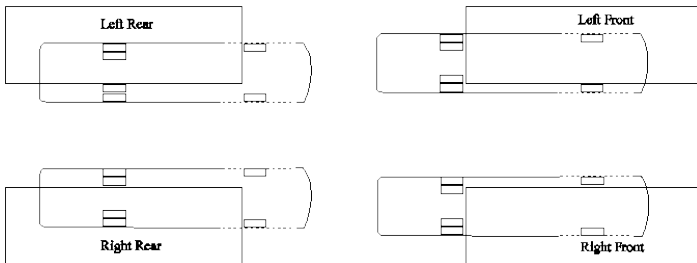

The recommended procedure to accurately weigh a motorhome is on individual corner scales. Since these are not always available, this diagram shows how to weigh a motorhome on a typical truck scale.

Since only one corner can be weighed at a time, the remaining three corners need to be as close to the scale as possible without being on the scale, and the unit needs to be as level as possible. Remember, wind and rain can cause inaccuracies of weights.



IMPORTANT

Your coach has been aligned at the factory as part of the production process. To provide optimum tire longevity and offer the best handling characteristics, Newmar recommends you have your unit re-aligned after loading your belongings. Though highly recommended, this alignment is not mandatory, and as such, is not warrantable by Newmar or the chassis manufacturer.

For More Information

Refer to the "Tire Inflation Pressure Technical Information" article to learn more about weighing your coach.

Routine Maintenance Schedule



IMPORTANT

Always follow the chassis maintenance guidelines found in the chassis manufacturer owner's manual.

All routine maintenance is the responsibility of the owner and is not covered by the Newmar Limited Warranty. Please note that damage caused by improper or unapplied maintenance is not covered by the Newmar Limited Warranty.



IMPORTANT

Cosmetic adjustments and alignments must be performed within the first three (3) months from date of original purchase for warranty consideration. Thereafter, these items are considered routine maintenance.

Items supplied by other manufacturers may require specific individual maintenance not listed herein. Please refer to the manufacturers' suggested maintenance guidelines in the Owner's Information Packet.

Weekly

- Test smoke alarm, carbon monoxide detector, and propane gas detector.

Monthly

- Check battery water level.

Quarterly

- Clean range hood exhaust fan filter and blades.
- Check gas lines for leaks with soap solution or leak detector.
- Check operation of windows, latches, and hinges.
- Clean the roof ducted air conditioner filter(s).
- Clean and inspect all door and window seals, and reseal where necessary.
- Inspect and reseal around the tub and shower area where necessary.
- Lubricate the exterior door hinges and latches with a graphite (silicone) lubricant.
- Check, clean, and tighten battery cables, and inspect batteries for proper fluid level.

Bi-Annually

- Inspect the slideouts for proper seals. If realignment is necessary, please contact an Authorized Newmar Service Center.
- Inspect the exterior rubber slideout seals, and apply a UV inhibitor, such as 303 Protectant.
- Rotate the tires as recommended by the tire manufacturer.
- Check all gas appliances for proper operation.
- Have the propane system inspected by a qualified technician.
- Lubricate the moveable parts on the entrance step.
- Check and replace water filters.

Annually

- Inspection of roof seams and joints should be performed by an Authorized Newmar Service Center. If resealing is necessary, it is the owner's responsibility and is not covered by the Newmar Limited Warranty.
- Check mounting bolts on all electric slideout motors for proper torque. This should be performed by an Authorized Newmar Service Center.
- Sanitize the fresh water system
- Wax and buff all gel-coat surfaces on the vehicle.

Appliances



Newmar only uses the most convenient and efficient appliances to make maintaining your coach -and your lifestyle - less of a chore. This category provides detailed information regarding each of the appliances available in your coach, including cooktops and ranges, dishwashers, fireplaces, microwaves and convection ovens, refrigerators, freezers and ice makers, central vacuums, washers and dryers, and water softeners.



IMPORTANT

Please note that all appliances are coach model and year-specific.

Under each sub-category, you will have access to owners manuals, user guides, parts and service manuals, and product specifications for each of the appliances available in your Newmar coach.

Appliance Data Label & Information Sheet

This sheet contains important information about your coach and can be found in the largest wardrobe in the unit, usually either in the bedroom or bathroom area. The label includes information such as:

1. The Newmar Serial Number (5 or 6 Digits)
 - This number is needed whenever making an appointment for service or for ordering parts through your Newmar dealer or service center.
2. Vehicle Identification Number (VIN)
 - This number is the legal identification of the completed vehicle and is used by the state for vehicle registration.
3. Year - Model - Type - Floorplan
4. Manufacturer, Model and Serial Number of factory-installed equipment and components.



IMPORTANT

The manufacturer, model, and serial number of the appliances and accessories installed at the factory in your unit are listed on this label for convenience. It is important that the label remain in the coach for identification purposes. Do not remove or relocate this label.

Safety Precautions

The following labels relating to the use of your propane or electric appliances may be placed throughout your coach. Follow all warnings to prevent coach damage, bodily injury, or death while operating these types of appliances.

⚠ DANGER	⚠ DANGER
<p>IF YOU SMELL PROPANE</p> <ol style="list-style-type: none"> 1. Extinguish any open flames and all smoking materials. 2. Shut off the propane supply at the container valve(s) or propane supply connection. 3. Do not touch electrical switches. 4. Open doors and other ventilating openings. 5. Leave the area until the odor clears. 6. Have the propane system checked and leakage source corrected before using again. <p style="font-size: x-small;">IGNITION OF FLAMMABLE VAPOURS COULD LEAD TO A FIRE OR EXPLOSION AND RESULT IN DEATH OR SERIOUS INJURY.</p>	<p>SI VOUS SENTEZ UNE ODEUR DE PROPANE :</p> <ol style="list-style-type: none"> 1. Éteignez toute flamme nue et tout article pour fumeur. 2. Coupez l'alimentation en gaz de l'appareil au réservoir ou au raccordement d'alimentation. 3. Ne touchez pas aux interrupteurs électriques. 4. Ouvrez les portes et toute autre ouverture de ventilation. 5. Quittez les lieux jusqu'à ce que l'odeur ait disparue. 6. Faites vérifier l'installation et colmater toute fuite avant d'utiliser de nouveau. <p style="font-size: x-small;">L'INFLAMMATION DES VAPEURS INFLAMMABLES POURRAIT PROVOQUER UN INCENDIE OU UNE EXPLOSION ET ENTRAÎNER DES BLESSURES GRAVES OU LA MORT</p>

⚠ CAUTION

Shut off gas supply before disconnecting appliance.

⚠ ATTENTION

Couper le gaz avant de déconnecter l'appareil.

GD0002

⚠ DANGER

All pilot lights, appliances, and their igniters (see operating instructions) shall be turned off before refueling of motor fuel tanks and/or propane containers.

Can cause ignition of flammable vapors, which can lead to a fire or explosion and result in death or serious injury.

⚠ DANGER

Éteindre les veilleuses, les appareils et leur dispositif d'allumage (voir les instructions d'utilisation) avant le remplissage des réservoirs de carburant et (ou) des bouteilles de propane.

L'avitaillement de carburant peut causer l'inflammation spontanée de vapeurs inflammables, ce qui peut causer un incendie ou une explosion et entraîner des blessures graves ou la mort.

AD-05F

⚠ DANGER

Do not use gas cooking appliances for comfort heating.

Can lead to carbon monoxide poisoning, which can lead to death or serious injury.

⚠ WARNING

Gas cooking appliances need fresh air for safe operation.

Before operating:

Open vents or windows slightly or turn on exhaust fan prior to using cooking appliance.

Gas flames consume oxygen, which should be replaced to ensure proper combustion.

Improper use can result in death or serious injury.

⚠ DANGER

Ne pas utiliser d'appareils de cuisson pour le chauffage des locaux.

Une telle utilisation peut causer un empoisonnement au monoxyde de carbone qui peut entraîner des blessures graves ou la mort.

⚠ AVERTISSEMENT

Les appareils de cuisson au gaz nécessitent un apport d'air frais pour fonctionner en toute sécurité.

Avant l'utilisation : ouvrir les événements ou entrouvrir des fenêtres ou actionner la hotte avant d'utiliser un appareil de cuisson.

Les flammes de gaz consomment de l'oxygène qui devrait être remplacé pour assurer une combustion adéquate.

Une mauvaise utilisation peut entraîner des blessures graves ou la mort.

DD-26F

Cooktops and Ranges

Style and function meet for a home cooked meal any night of the week, all at your fingertips. Newmar offers several styles and brands of ranges and cooktops for your coach. Whether a gourmet or beginner chef, your two or three-burner LP or electric range or cooktop will provide you with all of the necessities - and wants - you desire and deserve to prepare meals for you and your family.



IMPORTANT

These brief operation instructions are for quick reference only. Any quick start instructions provided should not take the place of the complete Operation Manual provided by this item's manufacturer.

Electric Cooktops

If your coach is equipped with the "All Electric" option, it will feature an electric cooktop in lieu of the standard propane cooktop. Before operating your electric cooktop, make sure the proper AC voltage is being supplied to the cooktop to activate the burner control to the desired heating level. The associated burner will heat proportionally to the setting. For induction cooktops, ferrous metal cookware is required to operate the cooktop.

Propane Cooktops



WARNING

Do not bring or store propane cylinders, gasoline, or other flammable liquids inside of the vehicle. Failure to comply could result in fire or explosion.

Your coach may be equipped with a two-burner or three-burner propane cooktop and may feature a manual or electronic spark ignition.

How to Operate Your Propane Cooktop

1. Before operating your propane cooktop, open an overhead vent, turn on an exhaust fan, or open a window.
2. To use the cooktop, simply press down and turn the burner control to the correct setting.
3. Manually twist the spark igniter or let the electronic ignition spark create a flame.
4. The burner controls will vary the flame to your cooking requirements.

Propane Safety

The following labels regarding propane safety are strategically placed inside of your coach.

<p>⚠ DANGER</p> <p>Do not use gas cooking appliances for comfort heating. Can lead to carbon monoxide poisoning, which can lead to death or serious injury.</p>	<p>⚠ DANGER</p> <p>Ne pas utiliser d'appareils de cuisson pour le chauffage des locaux. Une telle utilisation peut causer un empoisonnement au monoxyde de carbone qui peut entraîner des blessures graves ou la mort.</p>
<p>⚠ WARNING</p> <p>Gas cooking appliances need fresh air for safe operation. Before operating: Open vents or windows slightly or turn on exhaust fan prior to using cooking appliance. Gas flames consume oxygen, which should be replaced to ensure proper combustion. Improper use can result in death or serious injury.</p>	<p>⚠ AVERTISSEMENT</p> <p>Les appareils de cuisson au gaz nécessitent un apport d'air frais pour fonctionner en toute sécurité. Avant l'utilisation : ouvrir les événements ou entrouvrir des fenêtres ou actionner la hotte avant d'utiliser un appareil de cuisson. Les flammes de gaz consomment de l'oxygène qui devrait être remplacé pour assurer une combustion adéquate. Une mauvaise utilisation peut entraîner des blessures graves ou la mort.</p> <p>DD-26F</p>

<p>⚠ DANGER</p> <p>IF YOU SMELL PROPANE</p> <ol style="list-style-type: none">1. Extinguish any open flames and all smoking materials.2. Shut off the propane supply at the container valve(s) or propane supply connection.3. Do not touch electrical switches.4. Open doors and other ventilating openings.5. Leave the area until the odor clears.6. Have the propane system checked and leakage source corrected before using again. <p>IGNITION OF FLAMMABLE VAPORS COULD LEAD TO A FIRE OR EXPLOSION AND RESULT IN DEATH OR SERIOUS INJURY.</p>	<p>⚠ DANGER</p> <p>SI VOUS SENTEZ UNE ODEUR DE PROPANE :</p> <ol style="list-style-type: none">1. Éteignez toute flamme nue et tout article pour fumeur.2. Coupez l'alimentation en gaz de l'appareil au réservoir ou au raccordement d'alimentation.3. Ne touchez pas aux interrupteurs électriques.4. Ouvrez les portes et toute autre ouverture de ventilation.5. Quittez les lieux jusqu'à ce que l'odeur ait disparue.6. Faites vérifier l'installation et colmater toute fuite avant d'utiliser de nouveau. <p>L'INFLAMMATION DES VAPEURS INFLAMMABLES POURRAIT PROVOQUER UN INCENDIE OU UNE EXPLOSION ET ENTRAÎNER DES BLESSURES GRAVES OU LA MORT</p> <p>NI 0388</p>
---	--

Propane Distribution Lines

<p>⚠ CAUTION</p> <p>Shut off gas supply before disconnecting appliance.</p>
<p>⚠ ATTENTION</p> <p>Couper le gaz avant de déconnecter l'appareil.</p> <p>GD0002</p>

The primary gas supply manifold is a black steel pipe running the length of the unit. Most secondary lines leading to the gas appliances are made of copper tubing with flare fittings. If any of these lines rupture, do not attempt to splice them. Always run a new line. Gas distribution work must be performed by an authorized service technician.

<p>⚠ WARNING</p>	<p>When removing or servicing any gas appliance, close the main gas valve on the propane tank to prevent dangerous gas leakage that could result in an explosion and possible serious injury. If a gas leak is suspected, have the system inspected and repaired by a qualified service technician as soon as possible.</p>
-------------------------	---

The LP System and Climate Changes

While in high altitudes or extreme cold weather, a gas shortage may be experienced. Running one appliance at a time can help adjust to this problem.

For More Information

Refer to the product manufacturer's owner's manual and links to learn more about your coach's cooktop or range.

Dishwashers

The perfect complement to the array of residential-class appliances making clean-up a breeze. Your coach may be equipped with a locking dishwasher drawer. This optional appliance is mounted in the kitchen cabinetry below the range featuring a stylish and high-end look.



IMPORTANT

These brief operation instructions are for quick reference only. Any quick start instructions provided should not take the place of the complete Operation Manual provided by this item's manufacturer.

Operating Instructions

The dishwasher operates on 120 volt electricity. As with any appliance, maintenance is the key to keeping your dishwasher in top working order.

1. Load the dishwasher.
2. Add the detergent.
3. Make sure pressurized water and 120 volt AC power is available to dishwasher.
4. Select the cycle you prefer.
5. Let the dishwasher clean your dishes.

For detailed directions on loading dishes, adding soap and cleaning agents, cleaning and maintenance, and total operation, refer to the manufacturer's owner's manual.

Before traveling, lock the dishwasher drawer in the closed position. With some models, it may be necessary to turn the breaker off to the appliance in the 120 volt breaker panel to ensure the lock does not release during transit.



IMPORTANT

It is critical that the dishwasher drawer be locked into place any time the unit is in transit. If it is not, it can extend suddenly without warning, potentially damaging the dishwasher, its contents, the cabinetry, and may become dangerous to anyone standing near it.

For More Information

Refer to the product manufacturer's owner's manual and links to learn more about your coach's dishwasher.

Fireplaces

The fireplace provides instant comfort and ambiance to your home away from home.

Your fireplace is a 120 volt electric plug-in fireplace, complete with a thermostat-controlled, fan-forced heater. The fireplace may be operated using the flame only function with realistic flames. However, you may also have the option to turn on or off the heat function, providing you with flames and heat. Most fireplace models have an adjustable interior light and flame speed control. Select models can be operated via a remote control and may include a timer setting.

The following are examples of the controls you are likely to find on your fireplace, depending on your installed model. Exact switch locations may vary as fireplace models vary.

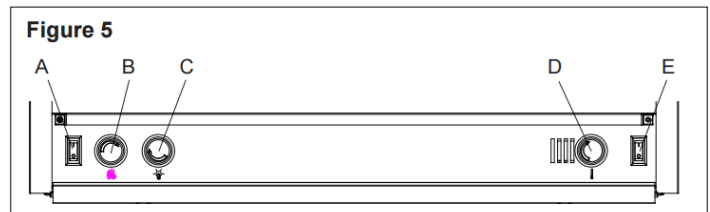
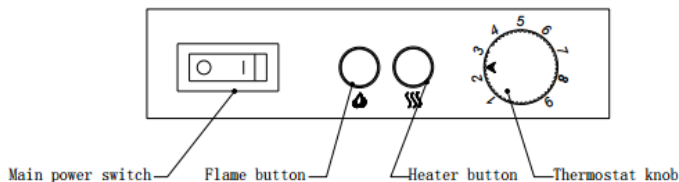

- A. The On/Off Switch supplies power to all fireplace functions.
- B. Turn the flame action control knob to adjust the flame speed to the desired level.
- C. Turn the interior light control knob to increase or decrease the brightness of the interior light.
- D. Heater Thermostat Control
- E. Heat On/Off Switch

For More Information

Refer to the product manufacturer's owner's manual and links to learn more about your coach's fireplace.

Microwaves and Convection Ovens

A modern convenience to keep up with even your busiest of travel days. Newmar offers a variety of microwave and convection oven choices to meet your needs and wants to make cooking quick and convenient. With multiple cooking functions, your microwave allows you to do much more than just warming up last night's leftovers. With the use of a combination of lights, microwaves, and convection heat, preparing entire meals is possible in a fraction of the time it takes in a conventional oven.



IMPORTANT

These brief operation instructions are for quick reference only. Any quick start instructions provided should not take the place of the complete Operation Manual provided by this item's manufacturer.

All microwaves and convection ovens operate on 120 Volt electricity. The control panel is a touch pad, so entering the temperature, mode, and cooking time desired is simple. For instructions on how to operate any of the special features on the microwave or convection oven, please refer to the manufacturer's owner's guide or operator's manual.

A range hood may be incorporated into the microwave. The microwave's control panel also operates the range hood functions, including the fan and light. The fan has two speeds: low and high.

For More Information

Refer to the product manufacturer's owner's manual and links to learn more about your coach's microwave or convection oven.

Refrigerators, Freezers, and Ice Makers

Offering all of the ingredients you need for a satisfying life on the road. Newmar offers many quality options for your food storage needs, all while blending beautifully with your sleek decor. With adjustable and removable shelving, your refrigerator and freezer provides you with the flexibility you need to fit your on-the-road lifestyle. Many models offer the convenience of electronic controls, a built in icemaker, and a filtered water dispenser.

Select models allow you to select the incoming power source of your coach, whether AC current or propane gas. All models are equipped with latches to secure the doors for a tight seal to prevent movement during transit.

Residential Refrigerators/Freezers

Residential-style refrigerators are the most popular option installed in Newmar coaches. The refrigerator operates on 120 volt AC power and uses freon and a compressor to keep your food cold and fresh. When placing on the racks and in the bins, leave enough space for air to flow throughout the entire refrigerator cabinet. For models with a built-in ice maker, a pressurized water supply is required. In order for the ice maker to operate, you must have water in the fresh tank and have the water pump turned on, or your coach must be connected to city water supply.

Absorption Refrigerators/Freezers

Absorption-style refrigerators are another option installed on select coaches. The refrigerator operates on 120 volt AC power or LP gas and heats a solution in a closed loop system. As the solution changes state and passes through the absorption stage, it cools the inside of the refrigerator and freezer box by extracting the heat and carrying it away in the solution. It does not use freon and a compressor, so this style of refrigerator takes longer to cool down. It is recommended to pre-chill food and beverages before putting them in the refrigerator and freezer. When placing on the racks and in the bins, leave enough space for air to flow throughout the entire refrigerator cabinet. For models with a built-in ice maker, a pressurized water supply is required. In order for the ice maker to operate, you must have water in the fresh tank and have the water pump turned on, or your coach must be connected to city water supply.

Exterior Freezers

The installation of a freezer in an exterior storage compartment may be an optional feature on your coach. This freezer operates on 12 volt and 120 volt electrical power. The freezer is on a slide for easy access for pre-travel packing or campsite unloading, as well as for easy storage while traveling.

For More Information

Refer to the product manufacturer's owner's manual and links to learn more about your coach's refrigerator, freezer, and ice maker.

Vacuums

Central cleaning systems make cleanup a snap, leaving you with more time to do what you enjoy. Your central vacuum removes dirt and debris inside of your coach. The central vacuum includes tools to effectively and efficiently clean all surfaces of your coach, including carpets, tile, furniture, window treatments, and more.



IMPORTANT

These brief operation instructions are for quick reference only. Any quick start instructions provided should not take the place of the complete Operation Manual provided by this item's manufacturer.

Operating Instructions

This vacuum operates on 120 volt AC power, is located in the basement, and is connected through piping to the interior of the coach. A dust pan-style outlet is located on the wall near the kitchen. If 120 volt power is being supplied to the central vacuum, open the dust pan door to turn on the vacuum. You may sweep dirt and debris into this opening for it to be properly discarded. To use the accompanying hose and accompanying attachments, install the hose into the round port in the wall outlet or directly into the round port in the central vacuum.



CAUTION

Do not use your vacuum for flammable liquids.

Vacuum Maintenance

This vacuum is equipped with a bag located in the vacuum in the basement. The bag will need to be changed as it gets full and suction decreases.

For More Information

Refer to the product manufacturer's owner's manual and links to learn more about your coach's central vacuum system.

Washers and Dryers

Depending on your floorplan, your coach may be equipped with an optional stackable washer and dryer, or an all-in-one laundry center. All of the units are located in a cabinet in either your bathroom or bedroom. Your laundry units are built for life on the road, so they are compact to save space, weight, and resources, without sacrificing performance.



IMPORTANT

These brief operation instructions are for quick reference only. Any quick start instructions provided should not take the place of the complete Operation Manual provided by this item's manufacturer.

Operating Instructions

The plumbing and other preparations for the installation of a compact washer and dryer are optional features on your coach. The washers and dryers used by Newmar function like those in a home. Most operate on 120 volt electricity; however, some dryers may require 240 volt electricity.

⚠ WARNING

Do not operate the dryer without opening a window or outside vent to provide outside air. Failure to comply may cause asphyxiation which could result in death or serious injury.

CS-91

NOTICE

Remove outside drain cap before operating washing machine.

NI-12



IMPORTANT

The gray tank valve must be in the 'open' position when operating the washing machine.

P-Traps

Each of the sink drains, the shower drain, and the washing machine drain (if equipped) has a water trap to prevent holding tank odors from entering the coach. These traps must have water in them in order to trap the odors. While stored, the water may evaporate, allowing an odor to enter the coach. If this occurs, run water from the faucet into the drain, allowing water to fill the trap. Run water into the washing machine. Set the cycle to spin to drain the water to fill the p-trap.

For More Information

Refer to the product manufacturer's owner's manual and links to learn more about your coach's washer and dryer.

Chassis



From the Chassis on up, Newmar coaches are built to be dependable, durable, comfortable, and beautiful. Built specifically for Newmar with the highest quality in handling, safety, performance, and dependability. This category provides detailed information regarding your axles and tires, as well as the collision warning, fuel control, leveling and towable braking systems in your coach.

Under each sub-category, you have access to owners manuals, user guides, parts and service manuals, and product specifications for each aspect of your Newmar chassis.

Newmar starts with an innovative chassis weld process to ensure that your coach drives with less noise, a smoother ride, and has a longer service life. After the chassis is leveled and squared, it is painstakingly integrated into the rest of the structure for strength and integrity. Sub-floor structures are welded to the chassis rail and are insulated for easy climate control.

Chassis Monitoring Systems

By collecting data from multiple sources, including the electronic engine computer, the system may collect, analyze, and save data in its memory, and then display the information on the rear vision monitor or other compatible monitor(s). The coach information and trip management computer is designed for select motorhomes and consists of multiple parts:

- A control pad
- Computer (behind dash)
- Compass and temperature sensors (optional)
- Tire pressure sensor/transmitters and receiver (optional)

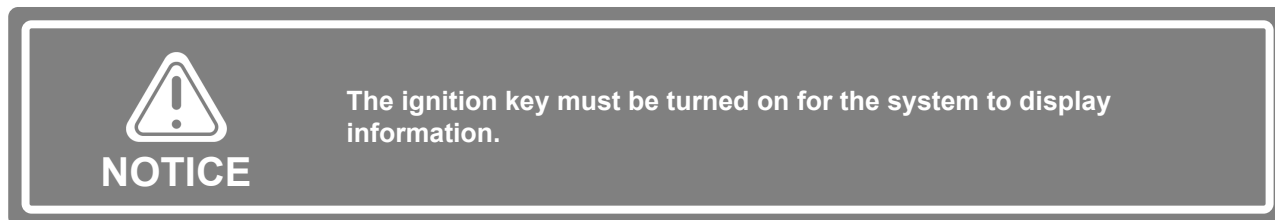

For More Information

Refer to the product manufacturer's owner's manual and links to learn more about your coach's chassis monitoring system.

Freightliner

¹ "At FCCC, we know that luxury motorhome owners deserve the ride and handling, support and ownership experience that can only come from a chassis builder with the heritage and backing of the global Daimler family. When we say we're "Driven by You," it means you can rely on us for the road ahead, so you can relax and enjoy the journey."

24/7 Direct: Customer Assistance or Concerns

Phone: 1-800-FTL-HELP (800.385.4357)

Web: <http://www.fccrv.com/owners/>

Email: fccservice@daimler.com

For More Information

Refer to the product manufacturer's owner's manual and links to learn more about your coach's chassis and maintenance schedule.

¹ Material sourced from <http://www.fccrv.com/>

² Material sourced from <http://www.fccrv.com/fccc/#contact-us>

Fuel Systems

This section provides information about the fuel systems in your coach, including LP (if equipped), chassis engine fuel, and auxiliary fuel tanks (if equipped).

Propane Fuel System

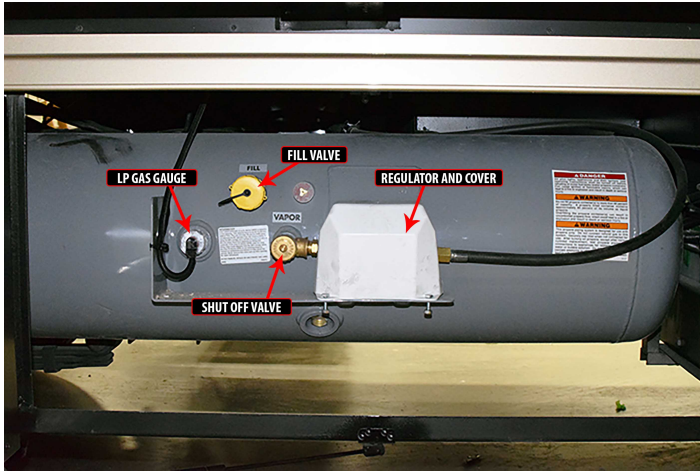

The components relating to the propane gas system in your coach have been approved for use in recreational vehicles by a nationally recognized testing laboratory. Propane gas is a clean-burning dependable fuel when properly handled.

It is recommended to have the propane system inspected by an authorized service technician at least once a year and after every extended trip. This system is tested by both the manufacturer and the dealer; however, leaks may be caused by travel vibrations.



Shut off the main gas valve at the tank when the vehicle is not in use.

CAUTION

Your coach may be equipped with an ASME (American Society of Mechanical Engineers) approved propane tank. This tank is controlled with an automatic pressure regulator. The propane tank contains liquid petroleum gas under high pressure. As the fuel is used, the liquid gas vaporizes and passes through the tank valve to a regulator that automatically reduces the pressure. The low-pressure gas is then distributed to the appliances throughout the pipe manifold system.



While in high altitudes or extreme cold weather, a gas shortage may be experienced. Running one appliance at a time can help adjust to this problem.

IMPORTANT

Propane Tank Filling

Tank filling should only be performed by trained professionals. Prior to filling the propane tank, turn off all flame or spark-producing appliances, extinguish any smoking items, and turn off the coach engine.



Inspect the propane fill valve for foreign materials before refueling. Introducing foreign materials into the fill valve may cause leaking or overfilling. Fire or explosion may be the result of uncontrolled gas flow from an overfilled tank.

WARNING

Chassis Engine Fuel



IMPORTANT

Consult your chassis manufacturer information about your recommended fuel and fuel blends, additives, and maintenance requirements.

Below are sample labels that might appear on the inside or outside of your coach.

ULTRA LOW SULFUR DIESEL FUEL ONLY

AD-117

GASOLINE ONLY

AD-10

NOTICE

Fuels containing alcohol (methanol, ethanol or cosolvents) may cause deterioration and/or corrosion of plastic, rubber and/or metals.

Problems arising from use of fuels with alcohol additives are not covered by New Vehicle and Emission control system warranties.

Do not use fuels with more than 10% ethanol or 5% methanol.

NI-16

DIESEL FUEL ONLY

Auxiliary Fuel (Toy Haulers Only)

For more information about your optional exterior fuel station, please see the Fuel Station sub-category beneath the Exterior category.

For More Information

Refer to the product manufacturer's owner's manual and links to learn more about your coach's fuel system.

Leveling Systems

This section has specific information about leveling systems for air, electric and hydraulic. Due to a very wide range of operation procedures, see the information under the brand and model which applies to your coach.



WARNING

Do not lift the wheels off of the ground while leveling the coach. The vehicle may drop and/or move forward or backward without warning, which may cause serious injury or death.



Never attempt to move the unit with the leveling jacks deployed. Always visually inspect the jacks prior to moving to ensure they are fully retracted, are in the stored position, and the system is turned OFF.



The leveling system should be cycled once a month or whenever the vehicle is used to keep the system in operating condition.



Be sure the ground on which you are parked will support the weight of your unit. Often material that seems “safe” to level on will not support the weight at the leveling jack points. Use caution when leveling on hot asphalt, sand, and grass, as the weight of the unit may cause the jacks to sink into the ground. Pads may need to be placed under the jacks to spread the weight over a larger area. Always look under your unit prior to leveling to make sure the jacks are clear of debris and other foreign materials that may interfere with leveling.



Never operate any leveling system with a person or pet under the unit. Serious injury or death may result!

Before Extending the Slideout



1. Park the coach on a reasonably level campsite.
2. Leave the coach at ride-height with air in the air bags (if equipped with air suspension) or on normal suspension (coaches without air suspension).
3. Plug the coach into shore power (if available).
4. For a full wall slideout, visually inspect the front vertical trim for adequate clearance. The spacing should look even from top to bottom. (See image for reference.)
5. Verify that the path of the slideout is unobstructed and free from any surrounding objects, both inside and outside of the coach.
6. Once the appropriate conditions are met, follow the operating instructions posted in your coach to extend the slideouts.
7. Deploy the leveling jacks.



In the unlikely occasion that the slideout trim has inadequate clearances, try leveling or repositioning the coach and rechecking the clearances before retracting the slideout.

Before Retracting the Slideout

1. Retract the leveling jacks.
2. Start the coach.
3. Allow the coach air suspension to fill and return to ride height (units without air suspension will return to normal suspension).
4. Turn the engine off.
5. Verify that the path of the slideout is unobstructed and free from any surrounding objects, both inside and outside of the coach. This includes any water or debris that may have collected on the topper awning.
6. Retract the slideouts.
7. Inspect all slideouts for complete retraction.
8. Unplug the coach from shore power when you are ready to depart.

For More Information

Refer to the product manufacturer's owner's manual and links to learn more about your coach's leveling system.

HWH Hydraulic Leveling Systems

¹"The ultimate in leveling systems. [HWH]'s BI-AXIS® computer automatically selects the fast, efficient way to level the vehicle. Hydraulic leveling systems deploy jack combinations to quickly level and stabilize the vehicle with minimum flexing of the coach structure. Single-Step leveling systems level the coach with the touch of one button. The Leveze® leveling indicator light system is standard on all systems."



WARNING

Read the Operation Manual for your specific leveling system, and follow all safety warnings and notices.



IMPORTANT

These brief operation instructions are for quick reference only. Any quick start instructions provided should not take the place of the complete Operation Manual provided by this item's manufacturer.



IMPORTANT

It is important to allow the HWH leveling system to run the complete cycle and turn itself off when operating in store mode. The system will completely retract the jacks and turn itself off. If the system is turned off prior to the automatic shut off, there is a chance the jacks have not fully retracted. Also, visually inspect the jacks prior to departure to ensure they have fully retracted and the underside of your unit is ready for travel.

²General Instructions

Maintain adequate clearance in all directions for vehicle, room extensions, awnings, doors, steps, etc. Vehicle may move in any direction due to jacks extending or retracting, settling of the jacks or the vehicle, equipment malfunction, etc.

If parking on soft ground or asphalt paving, a wood block or pad should be placed under each jack.

Press the "Cancel" button or turn the ignition switch "Off" at any time to stop the operation of the system.

Any time a hydraulic leveling process is interrupted, it is recommended to retract the jacks according to the jack retraction section and then restart the leveling process.

If the hand / auto brake is not set when the "Auto Level" button is pressed, the "Not in Park/Brake" light will come on. When the "Auto Level" button is released the "Not in Park/Brake" light will go out. The Automatic Leveling function will not start.

Automatic Hydraulic Leveling Operation

Place transmission in the recommended position for parking the vehicle and set parking brake. Turn the coach engine off. Turn the ignition to the "Accessory" position.



NOTICE

One or two yellow level indicator lights on the leveling system touch panel can be on anytime the vehicle ignition is in the 'On' or 'Accessory' position and the park brake is set.

At this time, the operator may want to check the jacks and place a pad under each jack if the ground will not support the vehicle.



WARNING

Prior to pushing the 'Auto Level' button, the operator must be sure that all persons and objects are clear of the vehicle. Air will be exhausted from the vehicle suspension and the vehicle will lower immediately after the 'Auto Level' button is pushed.

Press the "Auto Level" button one time. After selecting a reasonably level site and making site will support unit weight on jacks the Auto Level light will start to flash. The system will begin to dump air from the vehicle suspension. After approximately 25 seconds, the leveling process will begin.



IMPORTANT

During the Automatic Leveling procedures, pushing the 'Auto Level', 'Auto Store' or the 'Cancel' button on the HWH touch panel will stop the automatic leveling function.

Auto Level Sequence

During the automatic leveling sequence, after the system has extended the appropriate jacks to level the vehicle and has turned the yellow level indicator lights off, the system will then stabilize the vehicle.



NOTICE

The slight lift experienced during the stabilizing procedure normally is not sufficient to cause a level issue for the motor home.

Problem: Excess Slope

In the event the jacks are unable to level the coach, the "Excess Slope" light will come on... Retract the jacks and move the vehicle to a more level position or level the vehicle as close as possible according to the Manual Hydraulic Operation section.

Automatic Jack Retraction

Start the engine and press the "Auto Store" button. The store indicator light will flash. The vehicle should start to return to proper ride height. The front jacks will retract for 5 seconds before the rear jacks will begin to retract. As each jack retracts, its red "Warning" light will go out. The system will automatically shut down 1 minute after the four individual red "Warning" lights are out.



Do not move the vehicle while the leveling jacks are still in contact with the ground or in the extend position. This vehicle is equipped with straight-acting jacks. Moving the vehicle with the leveling jacks extended can cause severe damage to the jacks and/or the vehicle and create a driving hazard. Do not rely solely upon warning lights. It is the operator's responsibility to check that all jacks are fully retracted into the store/travel position and the vehicle is at the proper ride height for traveling.

The vehicle can be moved as soon as the red warning lights are out, the jacks are in the Store/Travel position and the green "Travel" light is on, if the vehicle is at the proper ride height for traveling.



If a red warning light and buzzer come on while traveling, the jacks should be checked as soon as a safe parking location is found.

Manual Hydraulic Operation

Place transmission in the recommended position for parking the vehicle, and set the parking brake. Turn the ignition to the "Accessory" position.

Place pads under the jack feet if the ground will not support the vehicle on the jacks.

Push the "Dump" button. Wait until all air is exhausted from the vehicle suspension.

The vehicle may be leveled using the manual Extend (up arrow) buttons on the right half of the panel. If a yellow Level Sensing light is on, that side, end or corner of the vehicle is low. It is best to level the vehicle side to side first, if needed, before front to rear.



Jacks will extend (or retract) in pairs to raise (or lower) a side or end of the vehicle. Any jack not used for leveling can be extended to the ground. This provides additional stability against wind and activity in the vehicle. Jacks used to stabilize the vehicle after leveling is complete should lift the vehicle slightly after touching the ground.



Do not continue to push an Extend button for more than ten (10) seconds after that pair of jacks are fully extended.

When leveling is completed, turn the ignition switch to the "Off" position.

¹ Material sourced from http://www.hwh.com/ml35809_2014.pdf

² Material sourced from <http://www.hwhcorp.com/ml55155.pdf/>

Spartan

"Riding on the industry's best Class A motorhome chassis means something more. From a superior ride to better handling, coach owners who choose a Spartan chassis can "feel the difference" from the first time they take the wheel. Motorcoaches riding on Spartan chassis offer a smoother, safer ride, combined with the hallmarks of quality and durability that last the lifetime of the RV."

Emergency Roadside Assistance

Phone: 888.890.1741

Recreational Vehicle Owner Support

Phone: 800.543.4277

Web: <http://www.spartanchassis.com/cps/about/contact.asp>

Email: rvcustomerservice@spartanmotors.com

Recreational Vehicle Service Center Support

Phone: 800.393.8861

Web: <http://www.spartanchassis.com/cps/about/contact.asp>

Email: dealerservice@spartanmotors.com

For More Information

Refer to the product manufacturer's owner's manual and links to learn more about your coach's chassis and maintenance schedule.

¹ Material sourced from <http://www.spartanchassis.com/rv/experience/experience.asp>

Steering Systems

Features like Newmar's Comfort Drive™ Steering allow easy maneuverability with just a light grip on the wheel, taking the chore out of driving long distances.



IMPORTANT

These brief operation instructions are for quick reference only. Any quick start instructions provided should not take the place of the complete Operation Manual provided by this item's manufacturer.

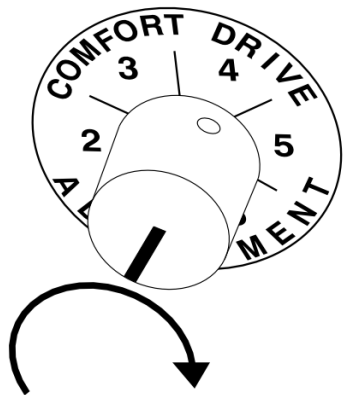

To use the Comfort Drive feature, simply steer the coach like you would any other vehicle, and adjust the dial on the dash to suit your preference for steering effort. A lower setting makes the coach easier to steer, whereas a higher setting requires more effort.

For More Information

Refer to the product manufacturer's owner's manual and links to learn more about your coach's steering system.

¹ Material sourced from https://secure.freightliner.com/newbulletins/techmanuals/DM-MM_Web/English/fccc/Driver's%20Manuals/recreational%20vehicle%20chassis%20operator's%20manual.pdf

Wheels and Tires

Newmar's quality extends to every inch of your coach, right down to the tires and wheels. The durability and longevity of your tires will provide you with the confidence and peace of mind you need to relax and enjoy the ride. This sub-category will provide you with information regarding the tire construction and size, inflation and pressure guidelines, as well as the proper use and care of your coach-specific tires and wheels.



WARNING

Proper tire maintenance is critical to the safety, operation, and durability of your coach. Failure to follow and monitor tire pressure guidelines may result in premature tire failure.

The primary areas of concern are the tire size, inflation, and operational information. The sidewall of the tire contains detailed information about the construction, inflation, and carrying capacity of the tire. Become familiar with this information, and operate the vehicle within the capacity parameters outlined.

The primary areas of concern are the tire size, inflation, and operational information. The sidewall of the tire contains detailed information about the construction, inflation, and carrying capacity of the tire. Become familiar with this information, and operate the vehicle within the capacity parameters outlined.

Tire Size

The sidewall of the tire contains information that is important to know to ensure proper use of the tire, as well as to maintain long life. Take the time to become familiar with the size, load rating, and pressure information listed on the sidewalls of the tires.



This tire size is 315 / 80 R 22.5. From this size, we can determine the physical dimensions of the tire, as well as its basic construction. The tire size breaks down like this:

- The first number, “315”, is the section width of the tire in millimeters. The section width is the measurement of the tire from the outside sidewall to the inside sidewall.
- The second number is the height of the sidewall, expressed as a percentage of the section width. In this case, the number is “80”, so the sidewall height accounts for 80 percent of the tire's section width.
- The “R” in the tire size indicates that this tire is “radial” in construction. The belts are wrapped around the tire in a radial design, from bead to bead.
- The final number is “22.5”, which is the rim size the tire was designed to fit. This tire fits a 22.5” diameter wheel.

Tire Care and Maintenance

To ensure your tires are operating safely, regularly inspecting your tires and checking your tire pressure is absolutely mandatory.



WARNING

Failure to follow proper inflation guidelines may result in tire failure, which can cause loss of vehicle control or accidents resulting in property damage, bodily injury, or death.

NOTICE! **CHECK WHEEL LUGS**

On first trip, tighten wheel lugs at start and at 10, 25 and 50 miles. Tighten to manufacturer's specifications.

Thereafter, check wheel lugs before each trip, after excessive braking and following winter storage.

AD-24

Tire pressures should be checked and adjusted before and after each trip. Always check and adjust the pressures while the tires are cold. Never add or release pressure from the tires when they are hot (after having driven a mile or more).

For safe operation and maximum weight carrying capacity, it is imperative that the tires be inflated to and maintained at the listed tire pressures on the Federal ID Tag. This tag is affixed to the interior wall just behind the driver's seat in your coach.



IMPORTANT

The tire pressure settings can change depending on whether they are used in single or dual tire situations.



IMPORTANT

Make sure the tire pressures are the same across an axle, while never exceeding the maximum air pressure limit stamped on the wheels or tires, or leaving a tire below the minimum pressure listed on your tire inflation chart.

If you are operating your coach while staying significantly under the maximum weight carrying capacity, you may experience an unnecessarily firm ride. To correct this condition, it is recommended for you to weigh the coach when it is fully loaded as you would travel, with full fuel, water, and LP tanks, all travelers, and your belongings, as well as any towed equipment. Weigh each axle end separately, and use the heaviest end weight to determine the axle's cold inflation tire pressure.

295/60R22.5 J												
PSI	85	90	95	100	105	110	115	120	125	130	Maximum load & pressure on sidewall	
kPa	590	620	660	690	720	760	790	830	860	900		
LBS	Single	5260	5505	5750	5990	6230	6485	6700	6930	7160	7390	S 7390 LBS at 130 PSI
	Dual	9650	10100	10550	10990	11430	11860	12290	12720	13140	13560	D 6780 LBS at 130 PSI
KG	Single	2385	2495	2610	2715	2825	2930	3040	3145	3230	3350	S 3350 KG at 900 kPa
	Dual	4375	4580	4785	4985	5185	5380	5575	5770	5960	6150	D 3075 KG at 900 kPa

Example of a Tire Inflation Chart

Use the inflation chart provided by your specific tire manufacturer according to brand, series, size, and load range. Also, pay attention to the chart when referring to dual or single tire configurations, as they will change based upon which tire you are inflating.



IMPORTANT

Do not use the example to find your recommended tire pressures. Refer to your tire manufacturer's owner's manual and specific tire inflation guidelines.



NOTICE

Exact tire inflation charts will not be provided by Newmar. Each tire manufacturer provides this information, as it changes by brand, make, tire series, tire size, as well as if it is used in a single or dual setup. For more information about your tires and the inflation specifications, please refer to the Item Home Page of your tire manufacturer.

For More Information

Refer to the product manufacturer's owner's manual and links, as well as the "Tire Inflation Pressure Technical Information" article, to learn more about your coach's wheels and tires.

Electrical



A Newmar coach's electrical and lighting system is designed for maximum reliability, functionality, and style. Electrical wiring holes in the aluminum frame are ringed with plastic grommets to protect wires from chafing. This category provides detailed information about the components of your 12 Volt and 120 Volt electrical systems, your chassis and house batteries, as well as your coach management systems and fuse panels.

Under each sub-category, you have access to owners manuals, user guides, parts and service manuals, and product specifications for each aspect of your coach's electrical system.



WARNING

Due to the risk of electrical shock, service should be performed by a qualified electrician or authorized service technician. The electrical system may have multiple 120/240 volt power sources. All power sources must be turned off, and any auto generator start features must be disabled prior to servicing.

12 Volt Electrical System

Provides general information about the components and functions of the 12 Volt Electrical System (DC) in Newmar coaches.

Power Sources

**THIS CONNECTION IS FOR
LOW-VOLTAGE BATTERY OR
DIRECT CURRENT ONLY. DO
NOT CONNECT TO 120 OR
240 VOLTS AC.**

AD-06

The 12 Volt Electrical System allows certain components to maintain a low voltage from the battery bank. The battery bank is controlled by the coach charging system, which consists of a charge bridge solenoid, a bi-directional isolator relay delay (BIRD), or a battery isolation manager (BIM). When the coach engine is running, the alternator charges the chassis batteries and may assist in charging the house batteries through the BIM, BIRD, or Charge Bridge.

When the coach is connected to shore power or when the coach generator is in use (when shore power is unavailable), the converter or inverter/converter combination recharges the house batteries, and with the assistance of a BIM, BIRD, or Charge Bridge, it can also charge the chassis batteries.

In addition to the alternator and converter, the coach may also be equipped with solar panels to provide an additional option for charging your house batteries.

Alternator

The alternator is a belt-driven component attached to the coach engine and is supplied by the chassis manufacturer. The alternator supplies power for chassis components such as batteries, lights, wipers, dash HVAC, and power seats, as well as all of the driver controls located in the cockpit. The alternator charges the chassis batteries, but with the addition of a BIM, BIRD, or Charge Bridge, it may also assist in charging the coach's house batteries.

Generator

When shore power is unavailable, the generator takes mechanical energy and converts it into alternating current to supply 120 volts to the coach and charge the coach's house via the converter or inverter/converter and the chassis batteries via BIRD, BIM, or charge bridge.

The generator is typically located in the front of the unit between the frame rails on diesel coaches. On gas units, the generator may be located anywhere between the mid and rear section of the coach. Generators can be powered by gas, liquid propane, or diesel fuel.

Converter and Inverter/Converter Combination

All Newmar coaches are equipped with a converter or inverter/converter combination. A converter transforms alternating current or shore line power 120 Volts to low-voltage direct current to provide power to the coach's 12 Volt house and chassis batteries. On the other hand, an inverter transforms direct current to alternating current to provide power to specified appliances and entertainment systems.

Solar Panel

Some Newmar units are equipped with a 10 Watt solar panel wired to the chassis batteries. Prior models may have a five or 10 Watt solar panel and may be wired to the chassis-side KIB panel.

Batteries

Please refer to the Battery Basics article for more information.

Power Distribution

Charge Bridge Solenoid



All current model Mountain Aire, London Aire, Essex, and King Aire coaches use Silverleaf, a computerized coach management system.

One of its many functions is to control the battery charging through the Charge Bridge Solenoid. The TM102 module monitors the battery state and senses the house and chassis battery voltage.

When the parameters are met, the TM102 module activates the solenoid, causing it to bridge or connect the chassis and house battery banks.

For more information on your coach's TM102 module, refer to the SilverLeaf Functional Guide.

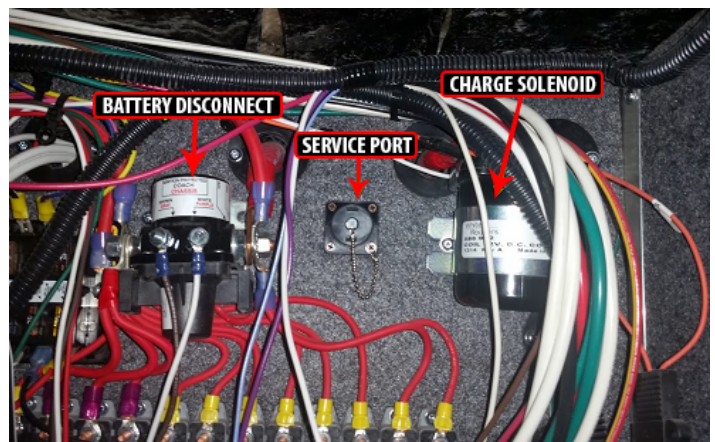

Battery Isolation Manager (BIM)



All current Dutch Star, Ventana, and Ventana LE diesel coaches, as well as gas coaches with 50 Amp electrical service, use a Precision Circuits all-in-one Battery Isolation Manager (BIM). The BIM monitors both the chassis and house battery and is the only place in the coach where they both merge. The BIM only functions when the engine or generator is running or when the coach is connected to shore power.

To learn more, visit the Battery Isolation Manager home page.

Bi-Directional Isolator Relay Delay (BIRD)



Current gas coaches with 30 Amp electrical service, as well as some older diesel coaches, use an Intellitec Bi-Directional Isolator Relay Delay (BIRD) with a separate solenoid. The BIRD monitors both the chassis and house battery and is the only place in the coach where they both merge. The BIRD only functions when the engine or generator is running or when the coach is connected to shore power.

To learn more, visit the Bi-Directional Isolator Relay Delay home page.

Battery Disconnect



Newmar uses an Intellitec disconnect relay connected to the battery bank to disconnect certain loads when placing the coach in storage. Keep in mind that not all loads are disconnected. This is very important to remember when a coach is put into storage and is not plugged into shore power. Before placing the battery disconnect in the "off" position, make sure the inverter (if equipped) is turned off.

When an older coach is stored while plugged into shore power, do not use the battery disconnect. If the battery disconnect is used, the chassis batteries will not receive a charge from the converter or inverter/converter combination. This is due to the coach battery wire being disconnected, meaning the BIM or the BIRD will not engage.

The Bay Star Sport has a manual rotary key switch to disconnect power, which is located in the overhead above the entry door. Fifth wheel products also used a manual rotary disconnect switch, which were normally located in the bathroom. All other coaches have a single lighted switch located in the front overhead that turns off the house voltage.



IMPORTANT

When the battery disconnect is 'off', meaning you have disconnected components from the batteries, there are still some loads on the batteries connected to the hot side of the Battery Disconnect Relay. Some of these loads may be Radio Memory, Entry Steps, and LP Detector. These will draw from the batteries, even when the disconnect is 'off'. Pull the fuse for each of the 'HOT' circuits to stop the batteries from being drained.

Fuse Blocks and Mini-Breakers

When a 12 Volt wire is ran, most of the circuits are protected with fuses or mini-breakers. These can be located at various areas in the coach but are typically located near the main breaker panel. However, they may also be found in areas such as:

Interior

- Rear bedroom
- Rear bathroom
- Closet

Exterior

- Power cord compartment
- Left, front electrical compartment (located beneath the driver window)
- Front firewall (gas coaches)



Sample: Cord Compartment Mini-Breakers

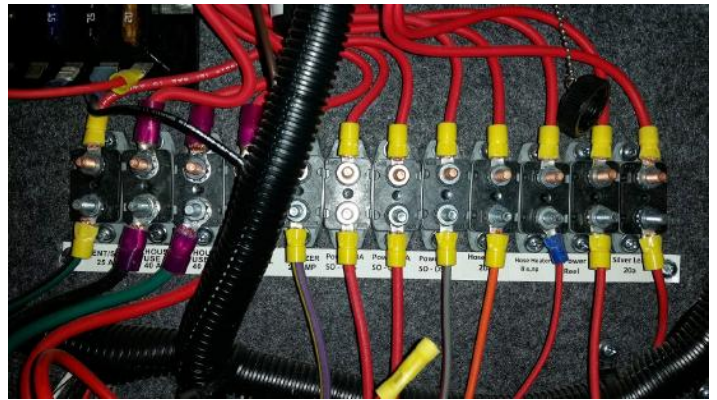

Sample: Cord compartment

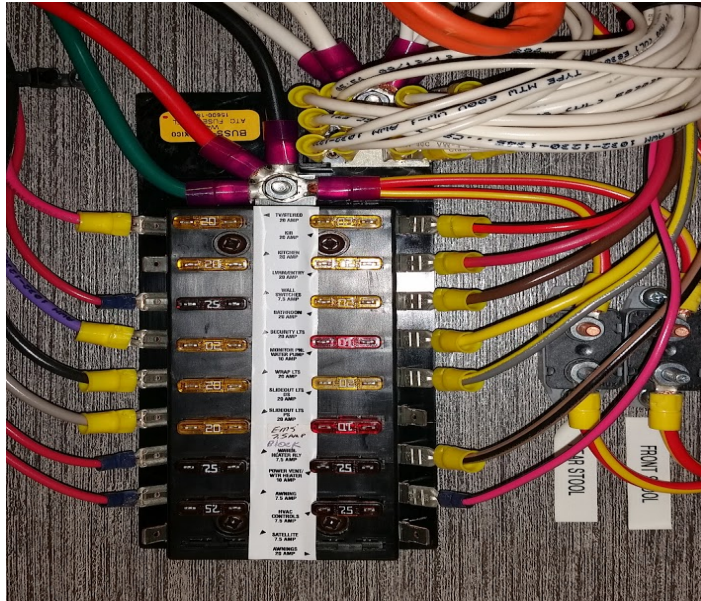

Sample: Front stool room

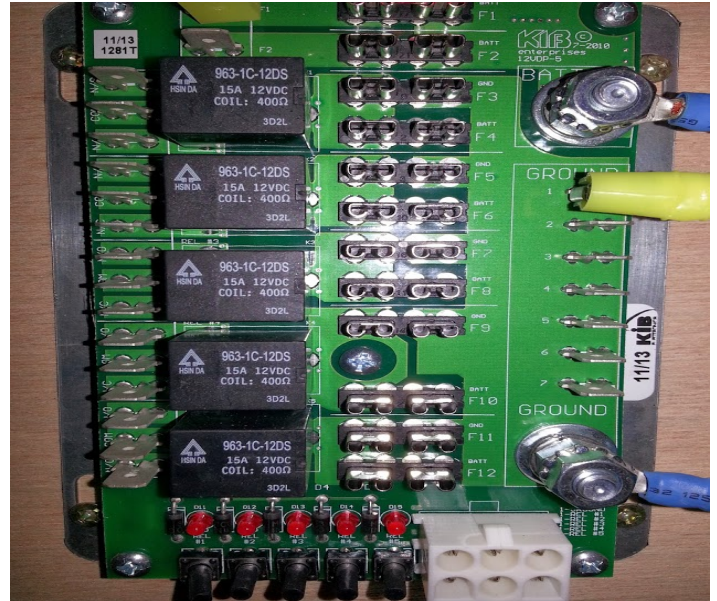

Sample: Fuse Block Board

There are also some circuits that are protected with an inline fuse. Some fuse blocks have fixed relays integrated on a board. The board below is located in the cord compartment.

Basic 12 Volt Power Flow

Since a battery is only an electrical storage component, 120 Volt power must be present to charge the batteries from the converter or inverter/ converter combination unit. It is necessary to have 12 Volt power supplied from the coach's house battery bank in order to operate the interior lights and other 12 Volt loads such as Slideout control systems, water pumps, vent fans, monitoring systems, etc. Most of this power flows through the battery disconnect to the fuse block or mini-breakers, which prevents overloading the circuit prior to progressing to the 12 Volt load. There are some 12 Volt circuits that do not go through the house battery disconnect; however, these loads still pass through a fuse or mini-breaker before progressing to the load.



IMPORTANT

When a 12 Volt load or component is not working, both 12 Volt power (+) and 12 Volt ground (-) are needed for the load to complete the 12 Volt circuit.

120 Volt Electrical System

Provides general information about the components and functions of the 120 Volt Electrical System (AC) in Newmar coaches.

Power Sources

There are three types of alternating current (AC) power sources available to the coach: shore power, generator power, and inverter power. Shore power is provided by the RV park or by home service outlets and should be used whenever possible. Generator power should mainly be used when shore power is not available, specifically while traveling, when 120 Volt power is necessary to run high amperage loads, or when dry camping requires 120 Volt for battery charging. Inverted power is mainly used for light 120 Volt loads when shore power is not available and generator power is not desired.

Generator Power



Generator power is produced within the generator and is output through the main wiring to the transfer switch. From the transfer switch, the power moves to the main breaker box where it is dispersed to individual circuits (outlets) and hard-wired components such as a water heater or boiler. From the inverted circuits, generator power will then travel through the inverter's internal transfer switch and back to the inverted subpanel to be dispersed through the individual breakers to the outlets or appliances.

Inverter Power



This type of power starts at the battery bank. The battery bank supplies 12 Volt power through cables to the inverter, which uses the 12 Volt direct current to produce 120 Volt alternating current. The inverter performs this action by using a transformer to increase the voltage and modify the higher voltage into a useable alternating current power. Power then goes to the inverted sub panel, which is dispersed through the individual breakers to the outlets or appliances.

The inverter may provide battery charging while 120 Volts is supplied via the generator or shore power. The inverter performs this action by using the transformer to decrease the voltage and rectify the alternating current into useable direct current voltage. This is regulated by internal sensing circuitry based upon the battery bank's state of charge and several other factors, depending on the coach's particular inverter brand and type.

Shore Power



Most RV parks provide 30 Amp, 120 Volt at the site; however, many parks also provide 50 Amp, 240 Volt service to accommodate the electrical needs of newer and larger coaches. Shore power is supplied to the coach via a power cord. Two sizes of power cords are found in Newmar coaches: 50 Amp and 30 Amp. The 50 Amp cords are made up of four conductors #8 stranded wire and a molded plug. The 30 Amp cords are made up of three conductors #10 stranded wire and a molded plug.

Shore power enters through the 30 or 50 Amp power cord to the power cord reel (if equipped). From the power cord reel, it travels to the transfer switch and then to the main breaker box where it is dispersed to the individual circuits to supply power to hard-wired components such as air conditioners, water heaters, etc. and then to the inverter (if equipped).

The inverted circuits move from the inverter's internal transfer switch to the inverter subpanel (a smaller breaker box). From the subpanel, the power circulates to the individual breakers and to the electrical outlets and appliances.

Shore Power Adapters



IMPORTANT

Newmar Corporation does not recommend use of adapter, cheater, or dog-bone style connectors that will modify the existing shore power cord to a different style of outlet. Use of this type of adapter will greatly reduce the amount of available current in the unit, as well as create the potential for electrical failure and/or fire.

If an adapter is used, there are three common sizes of power cord adapters available to adjust to a smaller amperage outlet:

1. 30 amp to 20 amp
2. 50 amp to 20 amp
3. 50 amp to 30 amp

It is important to understand the risks involved and the possible effects of using adapters in conjunction with your coach. Some of these risks and possible effects include:

- Melted or damaged adapters causing poor connection (or no connection at all)
- Melted or damaged 30 or 50 Amp plugs causing fluctuations in voltage that may damage electronics
- Insufficient amperage causing the tripping of a breaker at the post or a limited use of appliances

Low voltage can also be caused by use of adapters, long extension cords, or extension cords with an insufficient wire size.



30 amp to 20 amp adapter



50 amp to 20 amp adapter



50 amp to 30 amp adapter



IMPORTANT

Newmar Corporation cannot assume liability for failures occurring to the RV, its electrical system, or any of its components from the use of any electrical adapter.

Automatic Transfer Switch

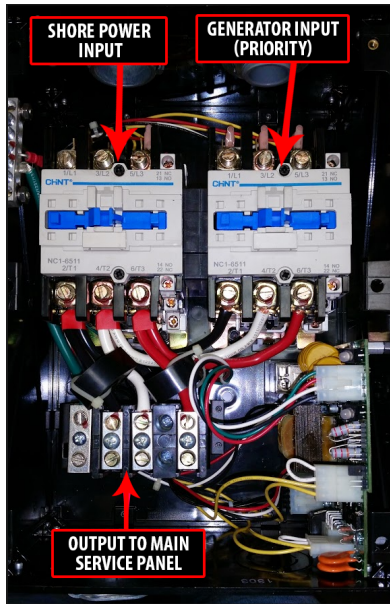

Current coaches with a generator will also have a transfer switch installed in the cord compartment. An automatic transfer switch converts two inputs and connects them to a single common output. The shore power cord is connected to one of the inputs, while the generator is connected to the transfer switch's second input.

Automatic transfer switches are logic-controlled to convert under a given set of conditions. The transfer switches used in RVs are typically generator priority switches which connect to shore power under normal use. As soon as the transfer switch detects the presence of 120 Volt power on the generator input lines, it will switch over to the generator's inputs and drop the connection to shore power.

Transfer switches are designed so that only one input can be connected at a time in order to prevent any back feeding of electrical power. In addition, RV transfer switches generally have a built-in delay allowing the generator to warm up and speed up before actually switching the load. This prevents stalling or stumbling while the engine is still cold and not producing full power.

Main Service Panel Breaker Box

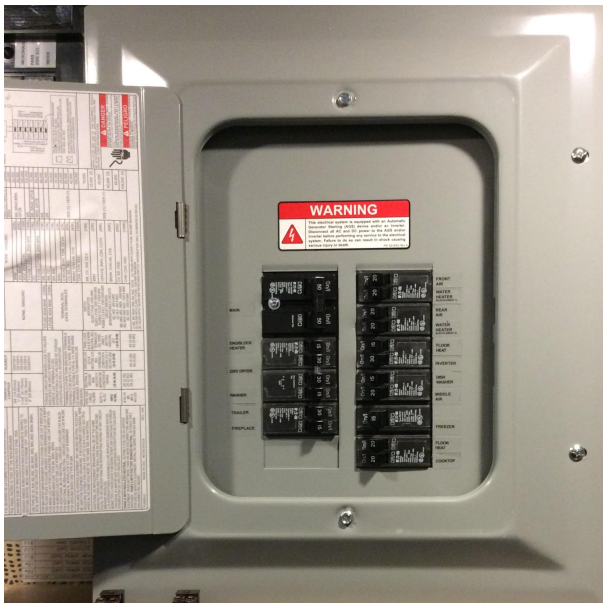

The main service panel or 120 Volt breaker box is typically located inside a bathroom, bedroom, or front overhead cabinet depending on the coach model and floor plan. The breaker box contains the main 50 Amp (or 30 Amp if equipped) breaker and the individual breakers protecting each circuit from overload conditions. Any unit equipped with two air conditioners or more must have 50 Amp service. The task of the breaker is to "trip" if the current exceeds the amperage rating on the breaker to prevent damage to the wiring of the circuit.

The breakers are resettable by simply flipping the breaker to the 'off' position, and then back to the 'on' position once the overload condition is removed. All 120 Volt circuit breakers are located in the main service panel unless the coach is equipped with an inverter/charger. These units are also equipped with a subpanel.



IMPORTANT

Breakers positioned next to each other are on different poles in a 50 Amp panel. If only part of the electrical circuits are working, you may have a poor connection at shore power. In this instance, power is most likely only being provided to one pole or leg.

Subpanel



The subpanel is a smaller 120 Volt breaker box containing the breakers for the circuits which the inverter is wired to power. It is typically located near the main breaker box unless the coach is equipped with an Energy Management System (EMS). In this case, the subpanel is often located within the EMS panel. The subpanel is installed to limit the AC power use to specific circuits when the electricity is supplied by the inverter. Some inverters may be used to power a specific circuit. In this case, a subpanel is not used.



50 Amp Energy Management System (EMS)

The 50 Amp Precision Circuits Energy Management System is currently offered as standard equipment on all Canyon Star, Ventana, and Dutch Star coaches. Its function is to provide power management for certain 120 Volt loads and as a system of energy management to minimize the overloading and tripping of circuit breakers. The EMS contains a main distribution panel with a self-contained control module and a remote display panel, which is typically located in the dash overhead electrical control cabinet.

The EMS control module automatically senses the available power being supplied to the coach. The module determines whether it is connected to a 50 Amp (240 Volt) or the generator. On 120 Volt service, it is unable to determine if the source is providing 30, 20 or 15 Amp shore power. Depending on available power, it can control up to seven loads. The EMS controls air conditioner loads using low-voltage switching and other 120 Volt, heavy-load appliances, such as block heaters, water heating elements, and air conditioners. The EMS will also control the 2012 Magnum inverter charge rate or switch to invert depending on the charging status. The charger will only reduce once it is in float status.

The current-sensing relay will display the amperage on each leg. The EMS will start shedding loads and look at the AC current when it sheds a load, determining when it has enough current available to turn on the load again.

When the EMS sheds a load, it only looks at one leg to see how much of a load was shed. For coaches equipped with the SilverLeaf system, refer to the SilverLeaf Functional Guide for more information on your EMS.

Converters



All Newmar coaches are equipped with a converter or an inverter/converter combination. Converters are used to transform alternating current power (120 Volt AC) to direct current power (12 Volt DC). Converters supply the coach with 12 Volt power to operate systems in the coach and provide battery charging.

Newmar currently uses three sizes of converters: 45, 60, and 80 Amp models. Previous units may have a 55 or 75 Amp converter or two 45 Amp converters with a total of 90 Amps available. When replacing a converter, it is necessary to use the same size converter to ensure sufficient wiring and breakers for the converter's input and output ratings.

Possible causes of converter failure:

- Overheating caused by cooling fan malfunction or inadequate ventilation causing damage to the converter
- Blown fuses

Inverters

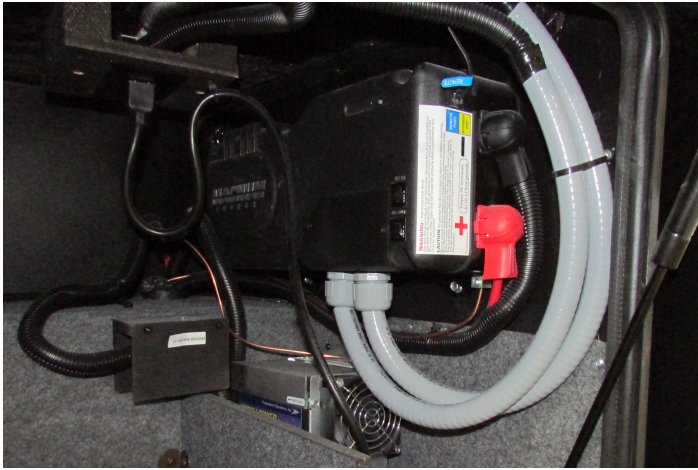

An inverter changes 12 Volt DC power to 120 Volt AC power. Coaches with an inverter only typically use it for powering the entertainment equipment like the TV, DVD, and Blu-ray players. The inverters used for this purpose are usually 600 watt to 1000 watt (1000 Watt inverters may also power a small refrigerator) and do not have battery charging capability.

The inverters are usually located in a basement compartment of the coach. Some inverters have a remote panel for an on/off switch in the overhead driver area or above the entry door. When power is supplied by either the generator or shore power, the inverter merely allows the power to "pass through" and will then stop pulling power from the batteries to try and supply 120 Volt power. There is a protective breaker on the inverter to prevent circuit overload.

Possible causes for inverter failure:

- Overheating caused by inadequate ventilation causing damage to the inverter
- Overloading the circuit causing "tripped" breakers

Inverter/Converter Combinations



Many Newmar coaches are equipped with inverter/charger combination units, sometimes referred to as an inverter/converter unit. These units range from 1200 to 3000 Watt and serve as a three stage charger and an inverter. Coaches equipped with this option will also be equipped with a 120 Volt subpanel.

The subpanel is used to limit the circuits powered by the inverter(s). This is necessary to avoid draining the batteries by supplying inverted power to all circuits. The subpanel is located next to the main service panel. On units equipped with an EMS, the subpanel is located in the same breaker box but is separated in the interior of main panel. The coach battery bank supplies the inverter 12 Volt power and has a high amp fuse link on the positive lead from the batteries and is located near the battery bank.

The inverter/charger can be controlled by a remote panel, from another system like SilverLeaf, or at the inverter itself. The remote panel is typically located in the front overhead compartment or above the entry door and is used to control the inverter and the battery charging functions. If a remote panel is connected to the inverter, then the remote panel takes priority.

Three-Stage Charging Process

The charging cycle uses three states: bulk, absorption, and float. During the initial bulk stage, the inverter charges at near its full current ability. This causing the battery voltage to rise over time. After the battery voltage reaches the bulk voltage setting, the charger starts the absorption stage.

During this phase, the charge rate is gradually reduced while the battery voltage is held near the bulk voltage setting. This insures that the battery is fully charged. The float stage is initiated when the battery has been held at the bulk voltage setting for the absorption period. At this point the battery voltage is allowed to fall to the float voltage setting, where it is maintained until another charge cycle is initiated. This reduces gassing of the battery and keeps it fully charged. A new three stage charging cycle is initiated after an AC source is reapplied to the AC input terminals.

Automatic Generator Start (AGS)

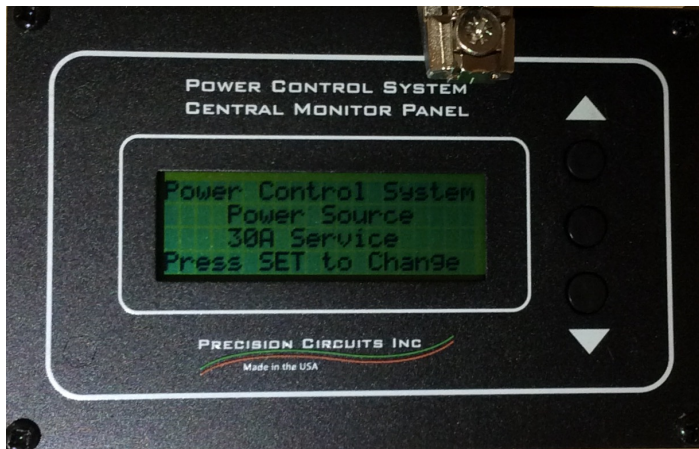

On units equipped with AGS, the generator will start and provide 120 Volt power if the incoming shore power voltage is not present and startup parameters are met.



IMPORTANT

This function must be enabled in order for the AGS to function properly.

Ground Fault Circuit Interrupt Outlets (GFCI)



The Ground Fault Circuit Interrupt (GFCI) outlets protect the user from ground faults between a hot wire and ground. The 120 Volt electrical outlets in the kitchen and bath area are GFCI protected receptacles. The electrical outlets located in the Slideouts are wired through the kitchen GFCI. The exterior electrical outlets are wired through the bathroom GFCI. On units equipped with the floor heat option, a separate GFCI is installed in the bathroom or near the main breaker box. Units with the holding tank heat pad option will have an additional GFCI located in the basement area; however, the exact location varies.

The GFCI outlets should be tested at least once a month. The 120 Volt electrical system must be energized in order to test the GFCI. The reset button needs to be pressed before starting the test. Then push the test button, which will cause the reset button to pop out, confirming the protected circuits have been disconnected.

Push the reset button again until a click is heard to reactivate the protected circuit. If the GFCI is working properly, the reset button will remain in the "IN" position. If an item plugged into a Slideout or outside receptacle is not working, check for a tripped GFCI in the kitchen or bathroom. Likewise, if the floor heat or holding tank heat pads are not working, check the GFCI for that circuit.



WARNING

The GFCI will not reduce the shock hazard if the short is between a neutral and hot wire or two hot load wires.

120 Volt Outlets



Several 120 volt receptacles are located throughout the interior of the unit. These receptacles require three-pin plugs that provide proper grounding to protect you from electrical shock. The breaker for the outlets are usually located in the breaker box. If the breakers are on the inverted circuitry, they will be located in the subpanel near the main breaker box.



IMPORTANT

Do not use an adapter, cheater, or extension cord that breaks the continuity of the ground circuit to the ground pin. Never remove the ground pin from a plug in order to connect it to a two-pronged ungrounded outlet.

Batteries

Provides information about the house and chassis battery banks, battery inspection and care, as well as battery replacement.

House and Chassis Battery Banks

There are two different battery banks in a Newmar coach: House and Chassis.

The House Battery Bank is necessary to operate everything a customer may require in order to live in the unit. These batteries can be either 6 Volt deep cycle (all diesel coaches) or 12 Volt deep cycle, depending on the model and brand of the coach. Newmar house batteries may be serviceable or sealed.

The Chassis Battery Bank supplies power to everything a customer requires to drive the unit. Currently, Newmar's chassis batteries are all Liquid Lead Acid. Spartan and Ford chassis have serviceable batteries and Freightliner chassis batteries are sealed. The type and brand of chassis battery may vary depending on coach year, make, and model. Chassis batteries may need to be disconnected and removed from the coach to maintain proper electrolyte levels or perform routine battery maintenance. House batteries may be either serviceable Liquid Lead Acid / Flooded or AGM / Sealed Cell.

The chassis batteries on your motorhome are installed and warranted by the chassis manufacturer. The coach (or house) batteries on your motorhome are installed by Newmar Corporation, but warranted by the battery manufacturer. These batteries are used to operate the 12 volt items that are not a direct part of the chassis. Depending on unit the batteries may be located in the front of the coach under the front cap or may be located on a pull out tray in an outside compartment.



Chassis Battery Bank Example



House Battery Bank Example



CAUTION

Do not use the motorhome with the coach batteries disconnected.

The chassis batteries are recharged by the vehicle's electrical system whenever the engine is running, with added BIRD, BIM, or Charge bridge solenoids the vehicle's charging system will also charge house batteries if parameters are met. A decline in the coach battery voltage may be noticed while the chassis batteries are being charged.

The converter will automatically charge the coach batteries when the unit is connected to a 120 volt outside power source. The chassis batteries are isolated from the coach batteries, however with certain parameters met the BIRD, BIM, or Charge bridge will activate and allow charge to the chassis battery also. This prevents the chassis batteries from being drained by the interior 12 volt equipment, allowing ample voltage for engine ignition.

Battery Inspection & Care



WARNING

Remove rings, metal watch bands, and other metal jewelry before working around batteries. Use caution when using metal tools. If a tool contacts a battery terminal or metal connected to it, a short circuit could occur which could cause personal injury, explosion or fire.



CAUTION

Disconnect the 120 volt electrical power cord and the negative terminal from the coach batteries before working on the electrical system.

Remember that when batteries are not used for an extended period of time, they may lose their charge. Periodic charging of the batteries during storage of the unit will increase the life of the battery. Check the external condition of the battery periodically. Look for cracks in the cover.

Check the vent plugs and replace them if they are cracked or broken. Keep the battery clean. Accumulations of acid film and dirt may permit current flow between the terminals, which could drain the battery.

To clean, wash the batteries with a diluted solution of baking soda and water to neutralize any acid present. Rinse thoroughly with clean water. Foaming around the terminals or on top of the battery is a sign that acid is being neutralized. Avoid getting the baking soda solution in the battery. Secure all vent caps. Dry the battery cables and terminals to prevent corrosion. Do not use grease on the bare metal inside the cable terminals. Grease can act as an insulator, and electricity will not flow through it. A plastic ignition spray will protect the terminals after they have been cleaned.



WARNING

Do not allow the battery fluid to contact your skin, eyes, fabric, or painted surfaces. The fluid could cause serious personal injury or property damage. Wear eye protection when working with any battery.

The batteries should be removed and stored in a warm place when not using your motorhome for an extended period of time. Mark the cables, positive and negative, for easy identification. Batteries are not to be stored on concrete floors. The batteries require periodic charging during storage. If the motorhome is to be stored for a long period of time, it is recommended that all of the batteries inside the unit be removed from clocks, radios, smoke alarms, etc. This will prevent unnecessary drain and corrosion of the batteries. The coach batteries are 6 volt RV/Marine deep cycle batteries. This type of battery consumes water and must be filled periodically. Please be sure to check the battery water level on a regular basis. Consult the owner's manual supplied by the battery manufacturer.

Replacing Your Batteries

Replacement batteries should be the same brand and capacity as the originals. Any time one battery is replaced, it is important to test the rest of the batteries in the system to make sure they are still functioning properly and efficiently. If one defective battery is replaced, while leaving another weak or defective battery, lowered performance, or ultimately damaging the new or good batteries, may result.



IMPORTANT

Charging batteries release gasses as the fluids inside boil, so it is critical to check the battery fluid levels regularly, particularly after extended periods of heavy use. Be sure to top off any battery that is showing signs of depleted fluid levels.

Battery Disconnect Switch

The switch is used to disconnect the battery when the unit is stored for any period of time. Pressing downward disconnects the coach batteries, not the chassis batteries. This is done to prevent the coach batteries from being drained during storage. It disconnects most of the 12 volt circuitry from the batteries, with the exception of the LP detector and various memory features. When taking the unit out of storage, press upward to reconnect the batteries. This will make the 12 volt system ready for use.

Depending on the chassis of the coach, diesel pusher motorhomes may be equipped with a second disconnect switch strictly for the chassis batteries. If equipped, this "Master Kill Switch" may be located in the rear engine compartment or chassis battery compartment. This switch disconnects all power to the chassis so that the engine cannot be started. It is used to prevent accidental ignition when the engine is being serviced.

For More Information

Refer to the product manufacturer's owner's manual and links, as well as the "Battery Basics" article to learn more about your coach's batteries.

Battery Basics

Introduction

As with anything technical, greater knowledge of the basics may help you increase performance, reliability, and longevity, as well as prevent future problems with your batteries. This article will provide information regarding your coach batteries; however, this is only one aspect of your coach's electrical system. To learn more about your batteries' role within the system, please refer to the 12 Volt Electrical article.

Commercial lead acid batteries have been used for over 150 years. The same chemical principal used to store energy now was also used many generations ago. Present day chassis battery power requirements are tremendous, considering today's vehicles and all of the electrical devices that must be supplied. All of these electronics require a reliable power source, and poor battery condition may lead to expensive electronic component failure. A battery is like a piggy bank - it stores energy, but cannot produce it. If you continue to withdraw without making any deposits, you will soon have nothing left.

Life Span of a Battery

Not long ago, motor homes only used a single 12 Volt house battery. Today, however, it is standard to have at least two batteries, and up to 16 total in some Newmar coaches, powering inverters up to 3000 watts. As energy requirements increase, the average battery life decreases. The life span of a deep cycle battery will vary considerably with how it is used, how it is maintained and charged, temperature, and other factors. The life span is dependent upon usage but often ranges between six months to 48 months. Only 30 percent of all batteries actually reach the 48 month mark.

One simple way to extend battery life is to hook it up to a solar charger during the off months.

It is best practice to change the complete battery bank when a new battery becomes necessary, as the battery bank is only as good as the weakest cell.

Common Battery Terms

Ampere (Amp) - A unit that defines the flow rate of electricity (current) in a circuit.

Amp Hour (AH) - Measurement of electrical storage capacity on a deep cycle battery. The standard amp rating is taken for 20 hours.

Example: A 100 AH rated battery is determined like this: Draw from the battery for 20 hours provides a total of 100 amp hours, translating to about five amps an hour (5 amps x 20 hours = 100 AH). However, it is important to know that the total time of discharge and load applied is not a linear relationship. As your load increases, your realized capacity decreases. This means if you discharged that same 100 AH battery by a 100 amp load, it will not give you one hour of runtime. On the contrary, the perceived capacity of the battery will be about 64 AH.

Cold Cranking Amps (CCA) - Measures the number of amps a battery can deliver at 0° F for 30 seconds without dropping below 7.2 Volts (1.2 Volts per cell). A high CCA battery rating is especially important in engine-starting battery applications and in cold weather. This measurement is not particularly important in deep cycle batteries, though it is the most commonly known battery measurement.

Cranking Amps (CA) - Measures available current at 32° F and is also called **marine cranking amps (MCA)**.

Depth of Discharge (DOD) - Measures the percent of rated capacity to which a cell or battery is discharged. It is the reciprocal of a battery's state of charge. Example: A battery that has a depth of discharge of 45 percent has a state of charge of 55 percent.

Reserve Capacity (RC) - Measures the number of minutes a fully charged battery can continuously deliver 25 amps at 80 ° F before the voltage drops below 10.5 Volts. This measurement represents the amount of time the battery can operate if a charging system failure occurs.

Electrolyte Specific Gravity (battery test) - Unit of measure which compares the weight of the electrolyte solution to the weight of water. This test is performed with a hydrometer or a refractometer that is made for testing batteries. This type of test is used to determine the battery's state of charge; however, it cannot be used on sealed batteries.

Battery Types

Liquid Lead Acid / Flooded

The Lead Acid battery consists of a plastic container with cells molded into it. Each cell contains plates, lead, and lead oxide (various other elements are used to change density, hardness, porosity, etc.) with 35 percent sulfuric acid and a 65 percent water solution. This solution is called an electrolyte, which causes a chemical reaction that releases electrons.

When testing a battery with a hydrometer, the amount of sulfuric acid in the electrolyte is measured. If the reading is low, the chemistry that makes electrons is lacking. The sulfur is now resting on the battery plates and will remain there until the battery is recharged and the sulfur returns to the electrolyte.

Absorbed Glass Mat (AGM) / Dry Cell

The Absorbed Glass Mat battery is just like a flooded battery, except the electricity is maintained in the glass mats, as opposed to freely flooding the plates. Very thin fibers are woven into a mat to increase the surface area to hold sufficient electrolyte on the cells for their lifetime. The construction allows the electrolyte to remain suspended in close proximity with the plate's active material, enhancing both the discharge and recharge efficiency.

When Deep Cycle AGM batteries are not discharged more than 60 percent, the cycle life could be approximately a few hundred cycles. If you do not use or operate your equipment daily, AGM batteries will hold their charge better than most other types. In most cases AGM batteries will provide a greater life span and cycle life than a Wet Cell battery.

AGM batteries are also often referred to as Sealed Regulated Valve, Dry Cell, Non-Spillable, and Valve-Regulated Lead Acid batteries.

Gel Cell Batteries

The Gel Cell is similar to the AGM battery because the electrolyte is suspended; however, the AGM battery is still considered to be a wet cell. The electrolyte in a Gel Cell has a silica additive that causes it to set (gel) or stiffen. The recharge voltage on this type of cell is lower than the other types of lead acid batteries, due to the likelihood of an adverse reaction to over-voltage charging. Gel Cell batteries are best used in very deep cycle applications and may last longer in hot weather applications.

House and Chassis Battery Banks

There are two different battery banks in a Newmar coach: House and Chassis.

The House Battery Bank is necessary to operate everything a customer may require in order to live in the unit. These batteries can be either 6 Volt deep cycle (all diesel coaches) or 12 Volt deep cycle, depending on the model and brand of the coach. Newmar house batteries are serviceable.

The Chassis Battery Bank supplies power to everything a customer requires to drive the unit. Currently, Newmar's chassis batteries are all Liquid Lead Acid. Spartan and Ford chassis have serviceable batteries and Freightliner chassis batteries are sealed. The type and brand of chassis battery may vary depending on coach year, make, and model.

Chassis batteries may need to be disconnected and removed from the coach to maintain proper electrolyte levels or perform routine battery maintenance. House batteries may be either serviceable Liquid Lead Acid / Flooded or AGM / Sealed Cell.

Parallel Battery Wiring

Parallel battery wiring refers to two or more batteries with all positive (+) terminals hooked together and all negative (-) terminals hooked together. This results in a battery voltage similar to that of the individual batteries, typically 12 Volt, to boost battery capacity. Two identical batteries wired parallel will provide twice the electrical storage capacity of one battery, without increasing voltage.

Series Battery Wiring

Series wiring refers to two or more batteries hooked together, with opposite terminals connected. The positive (+) terminal of the first battery should be connected to the negative (-) terminal of the second battery. The resulting voltage is the sum of the individual batteries. For example, if two six Volt batteries are hooked together, the resulting voltage will be 12 Volts.

Series/Parallel Wiring

Series/ Parallel battery wiring is used on Newmar units when four or more 6 Volt batteries are used for the house battery bank. Since 12 Volts is the desired working voltage from the battery bank, the batteries are connected to provide 12 Volts with more capacity. Two 6 volt batteries wired together in a series create a 12 Volt battery bank. Two or more of the 12 Volt battery banks can be connected together in a parallel format to provide more capacity.

In situations where multiple batteries are connected in a series, parallel or series/parallel, replacement batteries should be the same size, type, and manufacturer (if possible). Age and usage level should be the same as the companion batteries.

Battery Cycle vs. Battery Life

A battery cycle is one complete discharge and recharge cycle (100 percent to 20 percent, and then back to 100 percent). Battery life is directly related to how deep the battery is cycled each time. The most common cycles are 10, 20, and 50 percent. Be cautious of ratings that list the number of cycles, unless it also states how low the battery is being discharged.

For example, telephone type (float service) batteries have been advertised as having a 20-year life. However, the rating only stands true at five percent depth of discharge (DOD), and the life span is much less when used in an application where the batteries are cycled deeper on a regular basis. Those same batteries are rated at less than five years if cycled to 50 percent.

If a battery is discharged to 50 percent every day, it will last about twice as long as if it is cycled to 80 percent DOD. If cycled only 10 percent DOD, it will last about five times as long as one cycled to 50 percent. The most practical number to use is 50 percent DOD on a regular basis for the best use of effective storage and cost.

In addition, there is an upper limit. A battery that is continually cycled down five percent or less will usually not last as long as one cycled down 10 percent. At very shallow cycles, lead dioxide tends to build up in clumps on the positive plates rather than in an even layer.

Battery State/Voltage Chart

State of Charge	Specific Gravity	12 Volt	6 Volt
100%	1.265	12.7	6.3
75%	1.225	12.4	6.2
50%	1.190	12.2	6.1
25%	1.155	12.0	6.0
Discharged	1.120	11.9	6.0



IMPORTANT

This battery state voltage chart is used as an example. Your specific battery manufacturer's chart may vary.

Note: Both voltage and specific gravity tests should be performed with no load on the batteries and without any supplied charging. Turn off all draws and charging. Allow the batteries to stabilize, and then proceed with the test.

Battery Maintenance

Battery maintenance is an important issue often overlooked by many RV owners and technicians. As batteries age, their maintenance requirements change. This means longer charging time and/or higher finish rate (higher amperage at the end of the charge). Usually older, serviceable (unsealed) flooded batteries need to be watered more often, as their capacity decreases over time.



WARNING

Before attempting battery maintenance, make sure all coach power sources are disabled (ignition, generator, shore power, inverter).

Common Causes of Premature Battery Failure

Source: <http://www.batterystuff.com/kb/artic...ry-basics.html>

1. Deep discharges (leaving your lights on)
2. Misapplication
3. Replacement using an undersized battery not meeting Newmar's OEM specifications
4. Loss of electrolyte due to overheating or overcharging
5. Undercharging or loose alternator belt
6. Excessive vibration (due to loose clamp or hold down on battery)
7. Corrosion
8. Freezing (A fully-charged vehicle battery will not freeze until the temperature is -75° F. Frozen batteries are not warrantable.)
9. Failure to charge a battery during a period of six months or more (Inactivity can be extremely harmful to all lead acid batteries.)

Battery Safety Guidelines



WARNING

Prior to handling or working with a lead-acid battery, consult your battery owners' manual for instructions and safety precautions.

Lead-acid batteries contain hydrogen-oxygen gases that may be explosive and sulfuric acid that may cause severe burns. To avoid injury, observe these precautions when handling or working with a lead-acid battery:

- Wear ANSI (American National Standards Institute) approved safety glasses or goggles, as well as a face shield.
- Wear proper clothing to protect your face, hands, and body.
- Work in a well-ventilated area.
- Never lean over a battery while boosting, testing, or charging.
- Keep all ignition sources away from the battery. Cigarettes, flames, or sparks could cause a battery to explode.
- Always shield eyes and face from the battery.

- Do not charge or use booster cables or adjust post connections without proper instructions and training.
- Keep vent caps tight and level.
- In the event of an accident, flush eyes or skin with water, and call a physician immediately.
- Keep out of reach of children.

Cleaning the Battery

1. The battery should be cleaned using a baking soda and water solution. This should be a mixture of a couple of tablespoons of baking soda per pint of water.
2. Both house and chassis battery cable connections need to be cleaned and tightened, as battery problems are often caused by dirty and loose connections.

Checking the Fluid Level

1. A serviceable battery needs to have the fluid level checked. If the battery has removable vent caps, they can be twisted or pried off with a flat-head screwdriver. Once removed, the individual vent wells can be seen.
2. Look down into each individual cell to make sure that the water is covering the lead plates and is at the proper level.
3. Add water to any cells that are low on water. Ideally, the water level should be 1/8" below the bottom of the tubes (there are six tubes in a 12 Volt battery) that go down into the battery. To avoid damage to the battery, make sure the fluid level never drops below the tops of the lead plates in each of the cells. Always use distilled water to fill the battery to prevent battery contamination.

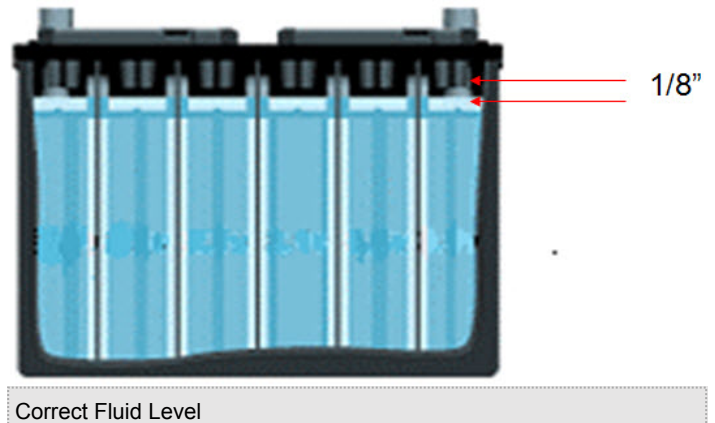

4. Do not overfill battery cells. Adding too much water may result in acid overflow and damage around the battery. In addition, warmer weather may cause natural fluid expansion, forcing excess electrolytes from the battery.

Preventing Corrosion

Newmar sprays the battery connections once they are tightened with a battery protector and sealer to help prevent corrosion. When performing battery maintenance, you should reseal the battery terminal connections. The following measures may also prevent future corrosion:

- Use a small bead of silicone sealer at the base of the post where it meets the battery case. Place a felt battery washer over the post and into the bead of silicone.
- Coat the washer with high temperature grease or petroleum jelly (Vaseline), then place the cable on the post and tighten.
- Coat the exposed cable end with the grease. The gas condensation on metal parts of the battery cause most corrosion issues.

Cord Reels

Cord reels (when equipped) provide the ease and convenience of storing the shore power electrical cord in a neat and compact space with the assistance of motorized retraction.

Operating Instructions

On coaches equipped with a power cord reel, pull out the power cord, and plug it into an appropriately rated electrical outlet. Make sure the power source is providing the correct voltage before plugging in the shore cord.

To store the cord, disconnect it from the power source outlet. Remove the cord from the pocket in the compartment, and press and hold the momentary switch to retract and roll up the power cord as needed.

For More Information

Refer to the product manufacturer's owner's manual and links to learn more about your coach's cord reel.

Dash Electrical Systems

Provides information about the coach dash harnesses, fuse panels, gauges, and switches.



NOTICE

The dashboard may contain several gauges and controls you have not previously used. Become familiar with all of these devices and their operation before starting out.

For More Information

Refer to your chassis manufacturer's owner's manual and links to learn more about your coach's dash electrical system, including information about instrumentation panel, controls, and switches.

Energy Management Systems

The energy management and auto generator start systems work behind the scenes to monitor the power supply and demand within the coach.

The system is designed to minimize the occurrence of tripped breakers for shore power and the generator while heavy loads are being used. The system turns off other loads temporarily while heavier loads are in use and restores power when heavy loads are turned back off. When 50 amp service is available, no action is required; however, 30 amp service (or less) requires setting the value of incoming power to be selected.



NOTICE

Whenever possible, connect coaches equipped with 50 amp shore power cord to 50 amp service, and connect coaches with 30 amp shore power cords to 30 amp service accordingly. It is the best practice to avoid using adapters and cheater cord devices.

Auto generator features may vary by coach model and options. Most AGS systems start the generator if shore power is unavailable and the HVAC system signals for air conditioner operation. Many systems will also start if automatically if battery levels reach the preset values.

For More Information

Refer to the product manufacturer's owner's manual and links to learn more about your coach's energy management system.

Fuse Panels

Provides information and the location of the house and chassis fuse panels.

Class A: Ford Fuse Panels

Inside of the Coach

On a class A coach, the house fuse panel, which controls most of the components and appliances inside the coach, is located in the bathroom. This panel contains fuses and breakers that are connected to all main appliances in the coach, from the refrigerator and television to the lights in the bedroom and slideouts. There are also some external components that are fused in the house fuse panel. For example, the fuses for the water pump, water heater, awning, and basement storage lights are located in this panel.



On Canyon Star 3911 models (handicap accessible units), this panel is located on the back wall of the bedroom, next to the 120 volt breaker panel.

The Ford chassis fuse panel is located on the sidewall, left of the driver's feet. This fuse panel supplies power to exterior lights, the tow plug, and the wipers. For exact details, see the Ford manual.

The Newmar fuse panel contains the chassis battery and ignition-powered fuses and is located on the firewall under the dash. This panel controls many of the components in the dash, the clearance/fog lights, and the engine compartment lights. The fuses for the dash blower, AC condenser, overhead fan, and power visor are also located in this panel.

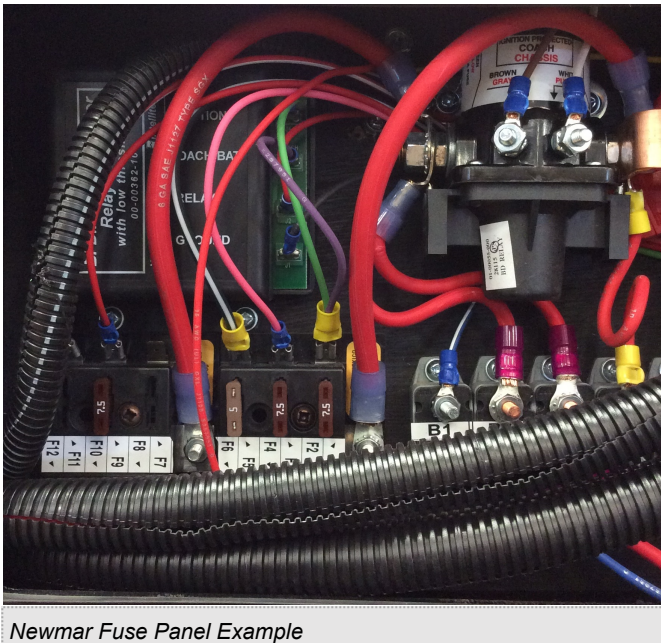

Newmar Fuse Panel Example



Class A House Fuse Panel Example

Outside of the Coach

House battery and disconnect fuses are located under the hood of the coach. These fuses control the battery boost, battery disconnect, and entrance steps. In this same location, there are also 12 volt circuit breakers that provide power to the ignition, house fuse panel, inverter, and the power seats (if equipped).

Diesel Pusher: Spartan or Freightliner Fuse Panels

Inside of the Coach

On a diesel pusher coach, the house fuse panel, which controls most of the components and appliances inside the coach, is located in the bathroom or in the front overhead next to the 120 volt breaker panel. This panel contains fuses and breakers that are connected to the main appliances in the coach, from the refrigerator and television to the lights in the bedroom and slideouts. There are also some external components that are fused in the house fuse panel. For example, the fuses for the water pump, water heater, security lights, and basement storage lights are located in this panel.

Outside of the Coach

House battery and disconnect fuses are located in the compartment with the shore power cord. This fuses control the battery boost, battery disconnect, keyless entry, hydronic heat, LP detector, and entrance steps. In this same location, there are also 12 volt circuit breakers that provide power to the house fuse panel, slideout motors, power awnings, and the entry step.

The Freightliner and Spartan chassis fuse panels are located in the left front baggage compartment under the driver's seat. An additional chassis circuit fuse panel is located in the chassis battery compartment on the rear passenger side of the coach. Both the Freightliner and Spartan chassis manuals contain detailed information on what fuses are located in these panels.

The Newmar KIB fuse panel is also located in the left front baggage compartment under the driver's seat. This panel contains fuses that power the dome light, front visor, and the solar panels (late 2015 model year), as well as for the

entrance step, back-up monitors, navigation, cargo lights, and keyless entry. The ignition lock-out for the slideouts and shades is also located on this fuse panel.

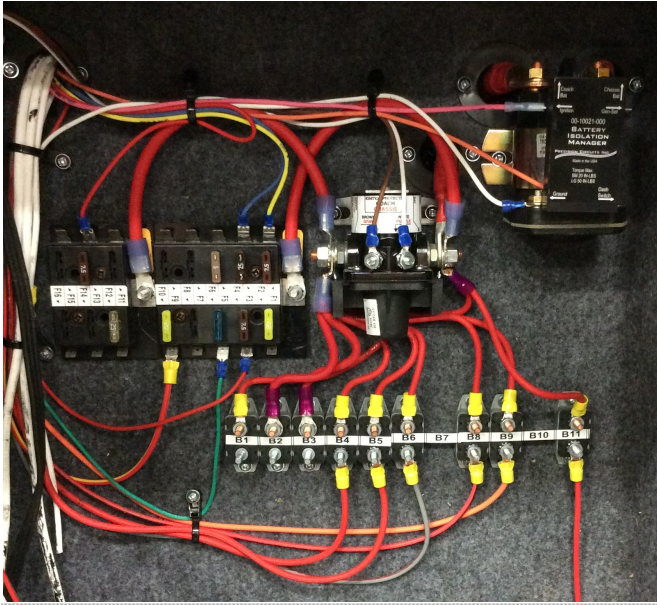

Shore Power Compartment Fuse Example

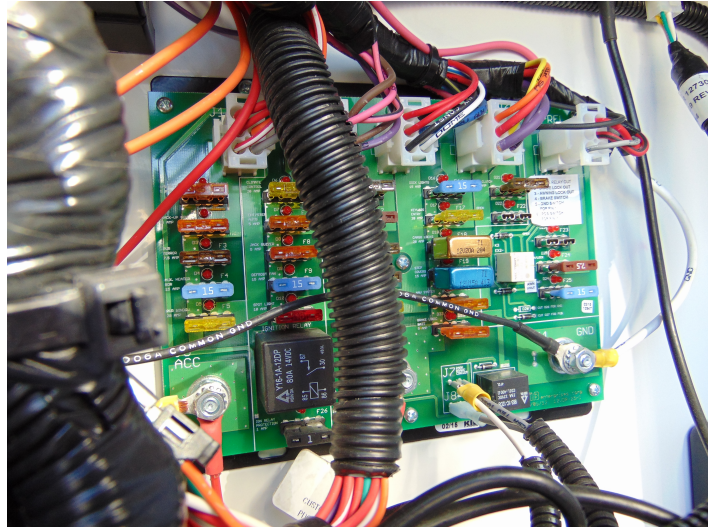

Example of a KIB Fuse Panel

For More Information

Refer to the product manufacturer's owner's manual and links to learn more about your coach's fuse panels.

Generators

Provides information for maintenance, operation, and safety for gas and diesel generators.



IMPORTANT

These brief operation instructions are for quick reference only. Any quick start instructions provided should not take the place of the complete Operation Manual provided by this item's manufacturer.

Your generator may be located in a side compartment or in the front of the coach in between the frame rails of the chassis. Some generators are mounted on slides for easy access and may need to be unlocked before free movement is allowed. The generator is wired into the Automatic Transfer Switch and will power all of the 120 volt circuits in your coach. The main breakers for the output legs are located on the generator start panel.

Maintaining the Generator

Before starting your generator for the first time each day, and subsequently after each eight-hour run cycle, perform the following checks to make sure it is ready to be used.

1. Make sure the carbon monoxide detectors in your unit are working.
2. Check for signs of fuel or exhaust leaks.
3. Make sure there is adequate clearance around the generator for proper ventilation. Also check for sloping ground or any other obstructions that may have occurred. Tall grass or other items that come in contact with the generator may interfere with ventilation or cause a fire.
4. Check the oil and coolant levels, and inspect for leaks.
5. Check the battery connections to make sure they are tight and clear of corrosion.
6. Inspect the generator compartment for road debris or damage that might affect the performance or safety.
7. Turn off major appliances (such as air conditioners, televisions, and other electronics that may excessively load the generator or may be sensitive to initial voltage surges).

The hour meter installed on the generator calculates the number of running hours of the generator motor. This is used for maintenance schedules. Regular oil changes and other maintenance performed at the prescribed intervals will greatly extend the life of your generator.

Operating the Generator

The generator can be started from the rocker switch on the dash, from other remote start switches (if equipped), from the start switch on the generator itself, or from the SilverLeaf touchscreen (if equipped).

1. To start the generator, rock the switch to the “start” position.
2. Release the switch once the generator has started. There may be a momentary delay in the Automatic Transfer Switch engaging to pass the electricity on from the generator.
3. After the generator has started, wait until the transfer switch has engaged before turning on any of the appliances.



IMPORTANT

Excessive cranking can damage the starter motor. Do not crank the generator more than 30 seconds at a time, and allow at least two minutes before trying again if the first attempt fails.



4. To stop the generator, press the rocker switch to the STOP position.



CAUTION

Failure to turn off the 120 volt appliances when starting or stopping the generator may damage the transfer switch and/or electrical appliances.

Generator Safety

 DANGER	 DANGER
<p>Vehicles and equipment powered by internal combustion engines and placed in recreational vehicles can cause carbon monoxide poisoning or asphyxiation, which could result in death or serious injury.</p> <p>The flammable liquids used to power these items can cause a fire or explosion, which can result in death or serious injury.</p> <p>To reduce risk:</p> <ol style="list-style-type: none"> Do not ride in the vehicle storage area when vehicles are present. Do not sleep in the vehicle storage area when vehicles are present. Close doors and windows in walls of separation (if installed) when any vehicle is present. Run fuel out of engines of stored vehicles after shutting off fuel at the tank. Do not store, transport, or dispense fuel inside this vehicle. Open the windows, openings, or air ventilation systems provided for venting the transportation area when vehicles are present. Do not operate propane appliances, pilot lights, or electrical equipment when motorized vehicles are present. 	<p>Les véhicules et l'équipement propulsé par un moteur à combustion interne placé dans un véhicule de camping peuvent causer un empoisonnement au monoxyde de carbone ou l'asphyxie, ce qui pourrait entraîner des blessures graves ou la mort.</p> <p>Les liquides inflammables utilisés pour propulser ces machines peuvent causer un incendie ou une explosion, ce qui peut entraîner des blessures graves ou la mort.</p> <p>Pour réduire le risque:</p> <ol style="list-style-type: none"> Ne pas circuler dans l'aire de rangement du véhicule si des véhicules s'y trouvent. Ne pas dormir dans l'aire de rangement du véhicule si des véhicules s'y trouvent. Fermer les portes et fenêtres qui se trouvent dans les cloisons (le cas échéant) si au moins un véhicule est entreposé. Épuiser le carburant contenu dans les moteurs des véhicules entreposés après avoir coupé l'alimentation en carburant au réservoir. Ne pas entreposer, transporter ou distribuer de carburant à l'intérieur de ce véhicule. Ouvrir les fenêtres, ouvertures ou systèmes de ventilation d'air fournis pour ventiler la zone de transport lorsque des véhicules s'y trouvent. Ne pas faire fonctionner d'appareils au propane, de veilleuses ou d'équipement électrique en présence de véhicules motorisés.

Vehicles and equipment powered by internal combustion engines and placed in recreational vehicles, such as a generator, can cause carbon monoxide poisoning or asphyxiation, which could result in death or serious injury.

Carbon monoxide is a colorless, odorless gas that is lethal. Symptoms of carbon monoxide poisoning are:

- Dizziness
- Nausea/Vomiting
- Headache
- Weakness
- Sleepiness
- Inability to think coherently

If you experience any of these symptoms, get fresh air immediately. If symptoms persist, seek medical attention right away.

Shut down the genset, and do not operate it again until it has been inspected and repaired.



DANGER

Always make sure the carbon monoxide detector in your unit is operating correctly.

Diesel Generators



The generator in your coach runs on the same diesel fuel as your main engine. The diesel fuel is drawn through a separate supply tube that is positioned in the tank in a manner that will not allow the generator to draw fuel and run if the tank level dips below the $\frac{1}{4}$ level.

Depending on the ambient temperatures, the generator may pre-heat prior to cranking. This pre-heat condition is noted by flashing the light on the generator start switch until the cycle is complete (up to 15 seconds). Once it has pre-heated sufficiently, the starter will engage and the engine will start.

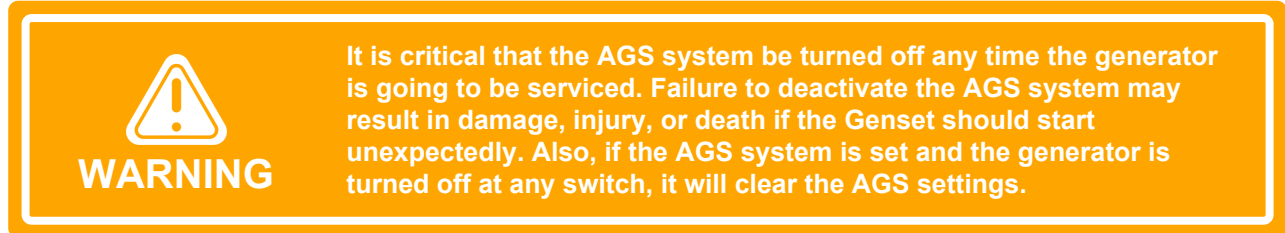
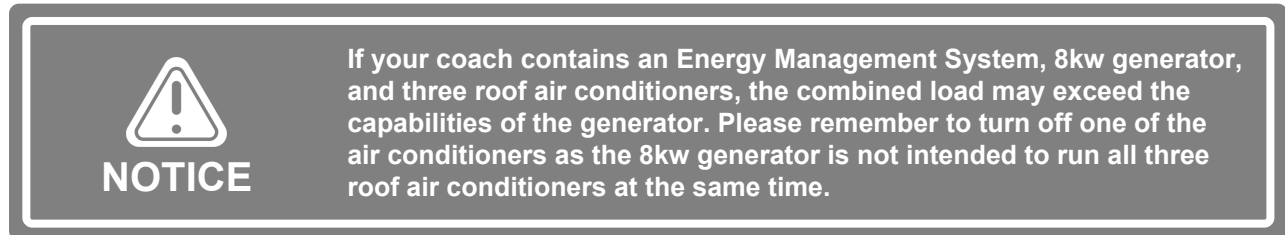

Gas Generators



The generator in your coach runs on the same fuel as your main engine. The fuel is drawn through a separate supply tube that is positioned in the tank in a manner that will not allow the generator to draw fuel and run if the tank level dips below the $\frac{1}{4}$ level.

For More Information

Refer to the product manufacturer's owner's manual and links to learn more about your coach's generator.

Inverters and Converters

Provides basic information about the role and operation of inverters, converters, and inverter/converter combination units.

Inverters

The inverter modifies direct current to alternating current to provide power to specified appliances and entertainment systems. The inverter performs this action by using a transformer to increase the voltage and modify the higher voltage into a useable alternating current power. For this function to occur, the inverter must be powered, set up, and turned on. A variety of inverters are used by Newmar; however, most have a control panel located in the overhead cabinet near the battery disconnect.

Inverter/Converter Combination Units

The inverter/ converter combination provides battery charging and allows the 120 volt power from shore power or the generator to pass through the inverter. The inverter performs this charging action by using the transformer to decrease the voltage and rectify the alternating current into useable direct current voltage. This is regulated by internal-sensing circuitry based upon the battery bank's state of charge and several other factors, depending on the coach's particular inverter brand and type. This type of unit also performs the inverter function. For this function to occur, the inverter must be powered, setup and turned on. A variety of combination units are used by Newmar; however, most have a control panel located in the overhead cabinet near the battery disconnect.

Converters

A converter transforms alternating current or shore line power 120 volts to low-voltage direct current to provide power to the coach's 12 volt house and chassis batteries. This function occurs automatically when 120 volts are supplied to the converter.

For More Information

Refer to the product manufacturer's owner's manual and links to learn more about your coach's inverter, converter, or inverter/converter combination unit.

Lighting

A Newmar coach's electrical and lighting system is designed for maximum reliability, functionality, and style. Your coach may feature traditional on/off switches or multi-switch touch panel light and accessory switch panels. Located throughout the unit, these switching devices are used to turn lights on and off, as well as to operate power shades and window treatments. Many coach models boast LED accent lights and new cloth-shaded LED wall sconces custom-designed for Newmar.

Operating Instructions

Control can be as simple as flipping the switch or touching the switch panel to operate the light or accessory you desire. Some lights may also have dimming features, allowing you to adjust the interior lighting for mood or comfort.

For More Information

Refer to the product manufacturer's owner's manual and links to learn more about your coach's lighting system.

Receptacles and Accessory Chargers

Newmar coaches are framed 16 inches on center, allowing the best placement of outlets, switches and other components.

12 Volt Outlets

Your unit is equipped with one or more 12 volt receptacles conveniently located in the dash area. These 12 volt receptacles allow you to plug in a variety of 12 volt DC accessories, including cell phone battery chargers, camera battery chargers, etc. These are fused at 20 amps.

120 Volt Outlets

Several 120 volt receptacles are located throughout the interior of the unit. These receptacles require three-pin plugs that provide proper grounding to protect you from electrical shock. The breaker for the outlets are usually located in the breaker box. If the breakers are on the inverted circuitry, they will be located in the sub-panel near the main breaker box.



IMPORTANT

Do not use an adapter, cheater, or extension cord that breaks the continuity of the ground circuit to the ground pin. Never remove the ground pin from a plug in order to connect it to a two-pronged ungrounded outlet.

Ground Fault Circuit Interrupt Outlets (GFCI)

The Ground Fault Circuit Interrupt (GFCI) outlets protect the user from ground faults between a hot wire and ground. The 120 volt electrical outlets in the kitchen and bath area are GFCI protected receptacles. The electrical outlets located in the slideouts are wired through the kitchen GFCI. The exterior electrical outlets are wired through the bathroom GFCI. On units equipped with the floor heat option, a separate GFCI is installed in the bathroom or near the main breaker box. Units with the holding tank heat pad option will have an additional GFCI located in the basement area; however, the exact location varies.

The GFCI outlets should be tested at least once a month. The 120 volt electrical system must be energized in order to test the GFCI. The reset button needs to be pressed before starting the test. Push the test button, which will cause the reset button to pop out, confirming the protected circuits have been disconnected. Push the reset button again until an audible click signifies the reactivation of the protected circuit. If the GFCI is working properly, the reset button will remain in the "IN" position. If an item plugged into a slideout or outside receptacle is not working, check for a tripped GFCI in the kitchen or bathroom. Likewise, if the floor heat or holding tank heat pads are not working, check the GFCI for that circuit.



WARNING

The GFCI will not reduce the shock hazard if the short is between a neutral and hot wire or two hot load wires.

Accessory Chargers



Your coach may have wireless charging devices built into your bedroom dresser, as well as into the dash. These devices are designed to charge your cell phone without ever having to plug it in; however, not all phones are compatible with this technology.

For More Information

Refer to the product manufacturer's owner's manual and links to learn more about your coach's receptacles and accessory chargers.

Solar Power

If your coach is equipped with a 5 or 10 watt solar panel, it charges the chassis batteries when exposed to sunlight. Larger solar panels may also charge the house battery bank.



IMPORTANT

It is important to note that the system may not indicate a charge any time it is exposed to sunlight. The built-in "regulator" will only allow the system to charge the chassis batteries when their voltage is low.

The solar panel is regulated to charge automatically. The following is an example of how the system may charge the based on battery voltage.

Battery Voltage	% of Battery Charge
12.7 Volts	100%
12.4 Volts	75%
12.2 Volts	50%
12.0 Volts	25%
11.9 Volts	0%

For example, if the chassis batteries are above 12.7 volts direct current, the solar panel may provide less charge.

Maintenance

The panel should be cleaned as needed to provide for the most efficient light absorption.

For More Information

Refer to the product manufacturer's owner's manual and links to learn more about your coach's solar panels.

Transfer Switches

Your unit may be equipped with an automatic transfer switch. The transfer switch allows your coach to be powered by more than one power source, while only allowing one active power source connection at a time. When the generator is turned on, this switch automatically transfers to generator power.

There will be a slight delay between the start of the generator and the electrical connection. This delay allows the generator to reach normal operating speed without needing to supply a required load. When the unit is plugged into shore power, an audible click will be heard in the transfer switch box. The sound is normal and indicates that the relay inside the transfer switch is engaging the outside power source.



Due to the risk of electrical shock, service should be performed by a qualified electrician or authorized service technician. The electrical system may have multiple 120/240 volt power sources. All power sources must be turned off, and any auto generator start features must be disabled prior to servicing.

For More Information

Refer to the product manufacturer's owner's manual and links to learn more about your coach's transfer switch.

Electronics



Multiple coach functions can be controlled at the tips of your fingers, including surveillance and security, lighting, holding tank monitoring, and if equipped, the total coach management system. This category provides detailed information about each of the electronic components available in your coach.

Under each sub-category, you will have access to owners manuals, user guides, parts and service manuals, and product specifications for each of the electronics available in your Newmar coach. For detailed information see your owner manual for the specific item or refer to Newgle.



NOTICE

Audio-Visual Equipment information is located in the Entertainment Systems category.

Camera and Video Monitoring Systems

This closed circuit television system features cameras mounted on the exterior of your coach and is connected to the in-dash video screen. This system comes on automatically when you put the transmission in reverse to allow you to see behind your unit when backing up. Additionally, it can be manually turned on in transit to allow you to monitor your towed vehicle or for additional assistance in passing maneuvers.

Rear View Cameras

Installed as a standard feature, the rear view monitor system assists the driver in the backing and parking of the vehicle. This system consists of a camera mounted on the rear cap and a monitor located on the dash.

Side View Cameras

As an option for the rear vision system, your unit may be equipped with “side view” cameras. These cameras are tied into the rear vision system and are activated by the turn signals. When a turn signal is activated, the monitor will switch to display that side of the unit. If the rear vision monitor is turned on manually, you can toggle through the cameras by using the “source” button, allowing you to stay on any given camera that you choose.

For More Information

Refer to the product manufacturer's owner's manual and links to learn more about your coach's cameras and video monitoring system.

Holding Tank Monitoring

The monitor panel allows you to check the approximate levels in the fresh, gray, and black water holding tanks, as well as propane levels (if equipped), and the battery condition. The monitor panel is generally located above or near the entrance door. An additional monitor panel may be located in the basement water compartment.

For More Information

Refer to the product manufacturer's owner's manual and links to learn more about your coach's holding tank monitoring system.

KIB Holding Tank Monitoring Systems

"This series of products allows you to quickly monitor your tank and battery levels with a push of a button."



IMPORTANT

These brief operation instructions are for quick reference only. Any quick start instructions provided should not take the place of the complete Operation Manual provided by this item's manufacturer.



The KIB Tank Monitor screen will either be blank or display the Newmar logo as a splash screen. From the splash screen, touch the moon icon in the lower right side of the screen to shut the display screen off.

Touch the screen to display the tank levels. After approximately two minutes, the tank monitor screen will default back to the splash screen.

The Tank Monitor screen displays the tank levels, as well as the house and chassis voltages. The battery bank voltages are green when above 9.5 V and change to yellow as the voltage drops below 9.5 V. The switches pertaining to your coach setup are located at the bottom of the screen.

Tanks values are displayed as a percentage value and increase and decrease in increments of five percent. A fill color is also used to show each tank level.

Tanks values are displayed as a percentage value and increase and decrease in increments of five percent. A fill color is also used to show each tank level.

- Fresh tank = Blue fill
- Grey tank = Grey fill
- Black tank = Black fill
- LPG = Orange fill (optional)
- Black Tank 2 = Black fill (optional)
- Grey Tank 2 = Grey fill (optional)

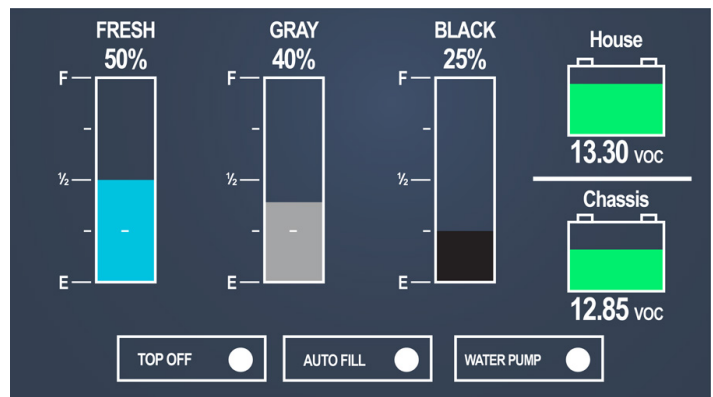

If your coach is equipped with an LP tank or with a second grey or black tank, they will appear on the screen as well.



IMPORTANT

The Top Off, Auto Fill, and Tank Heat switches are options at the bottom of the screen are features on select coach models only.

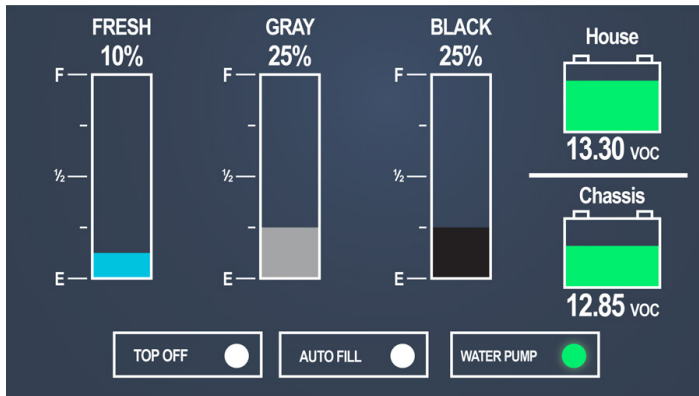

The water pump switch will activate or deactivate the water pump circuit.



IMPORTANT

In conditions where the tank level is below 50 percent when the auto fill or top off activates the water fill solenoid valve, the system will allow 15 minutes for the water level to reach 50 percent. If the water level reaches 50 percent within the 15 minute time limit, it will reset the timer and allow an additional 15 minutes for the tank level to reach 98 percent.

The Auto Fill function will energize or de-energize the auto fill circuit and will automatically refill the fresh water tank if the coach is connected to a pressurized potable water source. It will activate to fill at 50 percent and shut off 30 seconds after reaching 98 percent capacity to avoid overfilling. If it has not reached the 98 percent capacity within 15 minutes, the system will shut off the auto fill water valve.

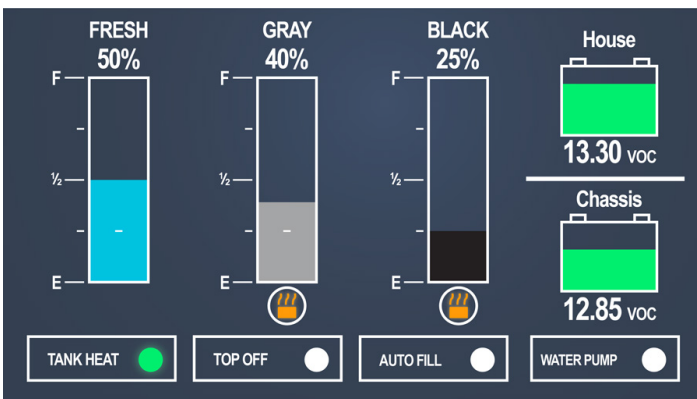
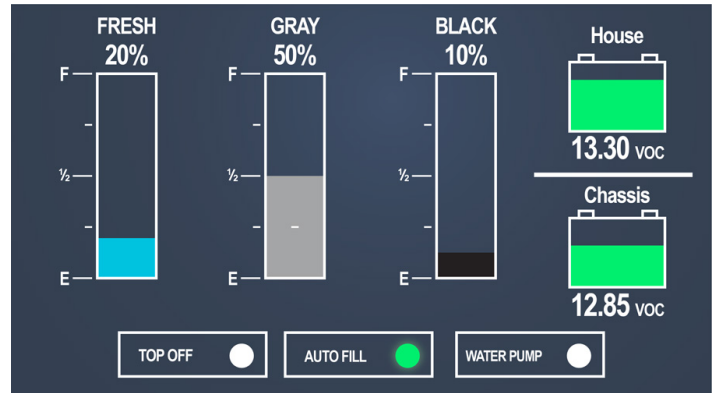

If equipped, the Top Off function will open the tank fill valve and allow the tank to fill. The Auto Fill function must be turned on in order for the Top Off function to work. This function should be used when you want to fill the tank when it is already about above 50 percent capacity. It is preset to shut down 30 seconds after reaching 98 percent capacity, as it follows the same timing as the auto fill function.

If your coach is equipped with tank heat and the switch is activated, the tank heat icon will appear under the grey and black tanks. Tank level must be at least five percent for the control panel to send power to the tank heater and has a one minute delay before activation.

Lighting Controllers

Lighting controllers switch the lighting circuits on and off. Select coach models may also have light dimming capability integrated as well. The system works behind-the-scenes to allow the coach to have multiple switch locations and configurations.

For More Information

Refer to the product manufacturer's owner's manual and links to learn more about your coach's lighting controllers.

Navigation Systems

Your coach may be equipped with a GPS based Navigation system. This system uses GPS technology to guide you through maps and information for traveling assistance. It features voice prompts and touchscreen technology to make scrolling through the menus and getting information incredibly easy.

The navigation feature is intended to assist you with guidance to your destination.

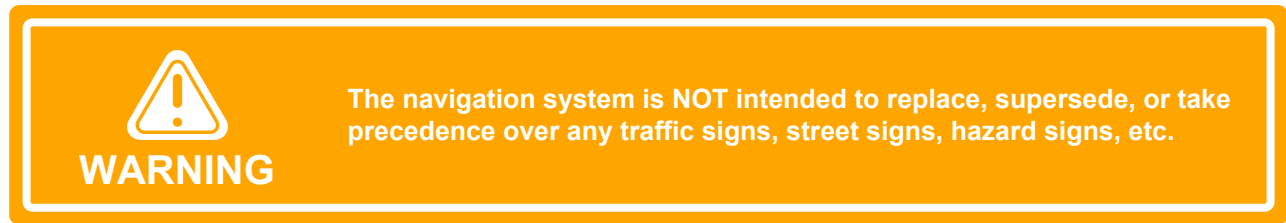

The system may need software and map updates. Updates are not warrantable issues, as roadways change over time and construction takes place, the maps and/or systems may become obsolete. It is the driver's responsibility to make sure the roads are safe and appropriately navigated and roadway weight limits and clearances are rated for the vehicle you are driving.

For More Information

Refer to the product manufacturer's owner's manual and links to learn more about your coach's navigation system.

Security and Keyless Entry Systems

Your coach may be equipped with an optional security system (on select models). This system uses a variety of sensors and switches to guard your unit and its contents. When armed, the system protects the entry door and the compartments equipped with a plunger switch.

Many Newmar coaches are equipped with a keyless entry system, which will allow for entry into the coach without the use of a key. It requires the user to have the correct code to unlock the door. Some coaches also have the same feature for the storage compartments.

Equipped units are shipped from the factory with a standard access code. When the unit is purchased, it is recommended that the customer obtain technical assistance in reprogramming a new access code while taking delivery of the unit from the dealer.

For More Information

Refer to the product manufacturer's owner's manual and links to learn more about your coach's security and keyless entry system.

Entertainment Systems



Newmar partners with the most prestigious names in mobile lifestyle, entertainment and technology. These brands are leaders in their fields – and legends in providing customers with new, unsurpassed levels of quality and reliability. Best in class performance from names you can trust. Stay entertained on the road and off, with spectacular visual and sound options from industry leaders.

This section provides information on entertainment components, including televisions, dash-mounted audio equipment, multi-disc players, home theater systems, and satellite antennas. Such components may be located within your coach's living room, bedroom, cargo area, or even outside of your unit in an optional exterior entertainment center.



NOTICE

Some of the components are optional and may not have been installed in your unit.

Exterior Entertainment Center

For your convenience and pleasure, an Exterior Entertainment Center may be an option on selected floorplans. It may be located in either a basement compartment or in the sidewall of the passenger side of the coach. Depending on the year, model, and floorplan of your coach, this entertainment center features an flat screen television, and may feature an AM/FM/CD stereo and speakers to provide outside music when desired. Some coach models feature a sound bar instead, and may also have an audio selector switch.

The television is mounted on a swivel bracket that allows you to swing the television out and away from the coach to provide better viewing angles. To release the television from its retainers, grasp the sides of the television firmly and pull it directly toward you. It will release and swing freely to the desired viewing position. To store the television for travel, swing it back into the opening, making sure that it is fully latched.

The external stereo can be used to listen to AM and FM broadcasts, as well as to play CDs. It may have some of the same functions and features as your in-dash stereo. The television in the exterior entertainment center can also be played through the exterior stereo or sound bar. If equipped with audio selector rotate switch to desired audio input for the sound bar.



IMPORTANT

The electronics used in the Exterior Entertainment Center are not designed for use in wet weather. The TV should be stored securely in the “travel” position and the basement door closed during rain or other adverse weather conditions. Caution should also be exercised when washing the exterior of your coach to make sure high pressure water does not enter the compartment. Spraying high pressure water at the seal between the doors can cause leaks, and potentially damage the electronics housed in this compartment.

Toy Hauler Garage Entertainment System

This entertainment center incorporates a television and stereo. The television can be used to tune local channels via the antenna (not connected to the DVD player inside the unit). The AM/FM/CD stereo is connected to multiple speakers in the garage area, as well as under the awning on the passenger side of the coach. The speakers can be turned on and off using the switch located inside the cabinet door above the radio.

Antennas, Cable, and Satellite Systems

Your unit may be equipped with an exterior antenna jack and interior antenna jacks or wiring at each television location. Depending on your coach year, model, and options, several antennas have been used.

An antenna with a power booster may be installed in your coach and is designed for reception of all local color and black-and-white channels. The antenna may be automatic, stationary, or manual lift. The power booster supplies voltage to the antenna when using over-the-air signal. However, it transfers the connection from antenna to park cable when it is available and connected.

Over-the-Air Signal

If the reception is poor, make sure the power switch for the power booster is in the “ON” position and all of the coax connections are tight. This switch is usually located beside the passenger chair or on video selector box (select units only).

Cable Connection

An exterior cable jack and receptacle may be features on your coach. If installed, these may be located in an outside storage compartment usually near the power cord. When using park cable, it is necessary to turn the antenna booster off in order to allow the signal to travel to the television or selector switch, if equipped. This switch is usually located beside the passenger chair or on video selector box (select units only).

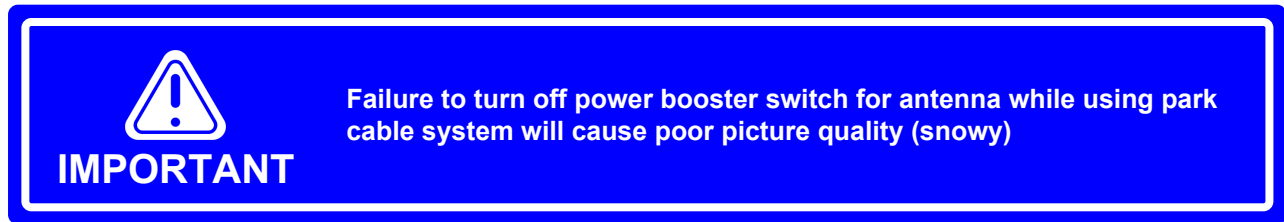

For More Information

Refer to the product manufacturer's owner's manual and links to learn more about your coach's antenna, cable, and satellite system.

Blu-ray Players

Blu-ray players offer full HD 1080p blu-ray disc playback. Many players also offer other features like streaming and a variety of applications.

Operating Instructions

To operate your blu-ray player, turn it on using the remote or on the face of the player. To insert a blu-ray disk, press the OPEN button, followed by the CLOSE button. Press the PLAY button on the remote or on face of the player. Make sure the proper source is selected on the television to view the blu-ray disk.

For More Information

Refer to the product manufacturer's owner's manual and links to learn more about your coach's blu-ray player.

Dash Receivers, CD Players, and Stereos

Your coach may be equipped with an AM/FM dash stereo radio with a built-in CD player. Some models may also include an auxiliary input jack for an iPod or MP3 player, or even offer bluetooth connectivity. Others may also play DVD/CD, as well as several other disk formats.

For More Information

Refer to the product manufacturer's owner's manual and links to learn more about your coach's dash receiver, CD player, or stereo.

DVD Players

Newmar has installed a variety of DVD players to enhance your entertainment experience.

Operating Instructions

To operate your DVD player, turn it on using the remote or on the face of the player. To insert a DVD, press the OPEN button, followed by the CLOSE button. Press the PLAY button on the remote or on face of the player. Make sure the proper source is selected on the television to view the DVD.

For More Information

Refer to the product manufacturer's owner's manual and links to learn more about your coach's DVD player.

Infrared Receivers, Remotes, and Switchers

On select coaches, all of the entertainment equipment can be operated with the use of a single universal remote. Infrared signal repeaters and switching devices can help aid in receiving and transmitting the signals to the proper place. Both systems work in conjunction to make your entertainment equipment easier to use.

For More Information

Refer to the product manufacturer's owner's manual and links to learn more about your coach's infrared receivers, remotes, and switchers.

Stereo Receivers and Home Theater Systems

To enhance the entertainment experience, a home theater or stereo receiver system may be installed in your coach. This system allows you to enjoy music, TV, or videos from DVD/ blu-ray via remote through a matching set of speakers and a subwoofer for deep, full bass sound. Select units may also use sound bar technology in lieu of a multi-speaker system.

For More Information

Refer to the product manufacturer's owner's manual and links to learn more about your coach's home theater system.

Televisions and Television Lifts

Your coach may be cable ready, and (depending on your floorplan) may have multiple flat screen televisions installed throughout the unit. The televisions are powered by 120 volt electricity, and the coach must be plugged into shore power, using the inverter (if equipped) or have the generator running in order for the televisions to function. The television operation is similar to most televisions used in the home.



IMPORTANT

These brief operation instructions are for quick reference only. Any quick start instructions provided should not take the place of the complete Operation Manual provided by this item's manufacturer.

Interior Televisions

The LED television(s) in your coach may be HD (High Definition) compatible, meaning they are capable of displaying the resolution and clarity of High Definition broadcasts and video sources.

Your coach may also be pre-wired for a satellite system and may be equipped with one interior television jack and an exterior television jack located on the passenger side of the coach. Choose the television source by selecting the input mode (air, cable, HDMI, etc.). The DVD player and satellite, if equipped, provides input to the front television(s) and exterior entertainment center. The bedroom DVD and satellite receiver, if equipped, provides input to the bedroom television.



IMPORTANT

The television in the front overhead cabinet will not operate while in transit. Federal regulations require this television to be inoperative while the vehicle is in use, so the power supply is switched off automatically when the ignition is turned on.

Television Lift

To operate the television lift, press the televator switch in the desired direction, and release the switch. The lift will continue in the selected direction until it reaches the end of travel. If you need to stop it at any time during the travel process, press the switch again. On select coaches equipped with the SilverLeaf system, the control may be located on the special features virtual keypad screen.



Exterior Entertainment Center

Your coach may also be equipped with an optional Exterior Entertainment Center, located in a basement compartment on the passenger side, or on the passenger side slideout. This entertainment center has a flat panel television mounted on a pivoting “swing arm” that allows you to rotate the television for optimum viewing.

Simply grasp the television, and pull it toward you to release it. Return it securely to the stored position prior to closing the compartment door and traveling. The source input programming is provided to this television through the “TV3” button on the Video Control Center.

The exterior entertainment center may incorporate a stereo system and speakers, a sound bar with a separate audio selector switch, or a sound bar without a separate selector that allows you to enjoy music or sound from the television through the exterior speakers.



IMPORTANT

It is important to make sure the TV is securely locked into position prior to closing the compartment door. Failure to do so can result in damage to the television case and screen.

For More Information

Refer to the product manufacturer's owner's manual and links to learn more about your coach's televisions and lifts.

Exterior



Experience as much, or as little, of the outdoors as you want in comfort and style. This category provides information regarding the exterior components on your coach, such as compartments, doors, paint, roof, and many other standard and optional accessories.

Under each sub-category, you will have access to owners manuals, user guides, parts and service manuals, and product specifications for each of the exterior components available on your Newmar coach.

Air Horns



Air horns may be installed on your coach in addition to the horn installed on the chassis.

A switch located on the dash allows you to choose either the chassis horn or the air horn. To operate either horn, press the center of the steering wheel. You may have a switch on the dash or driver side console labeled AIR HORN. Flip the switch for the desired horn, air horn or a normal electric automotive horn. The air horns on Newmar products may be located on the roof or under the front cap depending on year, and model.

For More Information

Refer to the product manufacturer's owner's manual and links to learn more about your coach's air horns.

Awnings

Awnings are a standard feature on your coach. Newmar offers a variety of brands and types of awnings, depending on the year and model of your coach, as well as the available options that were selected at the time of your coach's manufacture.

Patio Awnings

The patio awnings are the larger-sized awning on the coach and are often referred to as the main awning. These awnings connect at or near the roof, providing shade, light, and rain protection on the passenger side of the coach.

Entrance Door and Window Awnings

Select models may also feature slideout toppers, entrance door, and or window awnings. The powered patio, window, and door awnings (if equipped) on your coach can be operated with ease.

How to Operate Your Awnings

Use the appropriate switches to extend or retract the awnings as desired. Slideout toppers or covers operate as the slideouts are extended and retracted.

CAUTION

Awnings should be retracted during accumulating rains. Pooling water on the awning can result in damage to the awning hardware and/or fabric.

NI-132



IMPORTANT

Prior to extending any of your coach awnings, check for any obstructions that may prevent the awnings from deploying properly. Inspect the area around your unit where the awning will extend to ensure proper clearance.



NOTICE

Damage to your awnings as a result of weather is not covered by warranty.

For More Information

Refer to the product manufacturer's owner's manual and links to learn more about your coach's awnings.

Compartments

Storage compartments are located on the exterior sides of your unit. These compartments provide additional space for your belongings while you are traveling. Select coach models feature optional manual slide trays and standard lighting, while others may feature compartments complete with power slide trays, dual side access, and automatic LED lighting throughout the storage area.

WARNING

This compartment is not to be used as a storage area. Storage of combustible materials or containers on or near any appliance in this compartment may create a fire hazard. Do not store such materials or containers in this compartment.

DD-67

WARNING

Do not occupy this area while bumper slide is in operation.

Failure to remain clear of this area could result in death or serious injury.

NI-092

Storage Compartments

Use caution when packing the storage areas. Do not pack items around water heaters, refrigerators, furnaces, hydronic heating units, or any other heat-producing appliances.

Before traveling, perform a pre-trip inspection that includes checking each baggage door to ensure each one is latched and locked securely.

Exterior Water Compartment

All plumbing functions can be controlled from this location. Additionally, the connection points for city water, sewer rinse, and holding tank draining are all located in this compartment. For more detailed information, visit the Fresh Water System and Waste Water System pages under the Plumbing category.

Generator Compartment

Select coach models are equipped with a powered generator slide compartment to provide easier access to the generator, fire wall, and other components located below the dash between the front cap and the firewall. Do not place anything in front of or between the slide area of the front bumper and cap, including persons, while in operation or during service of the slide system.

Push Button Activated Compartment Locks

Select coach models may be equipped with storage compartments with push button locks. Under normal operation, push the button to release the door.

In the event of a power failure, the compartments can be manually accessed using the cable loop or cable lock feature located underneath most compartments. The pass-through bays are the exception, as they may have only one compartment with access on each side.

To manually access the compartments equipped with a cable lock, insert the #751 key into the lock hidden at the bottom of compartment by the radius of the compartment door.

To access the compartments equipped with a cable loop, locate the cable loop under the compartment near the latch side, and pull on the cable until the compartment door releases. Most cables will pull straight down to release. The battery compartment cable releases easier by pulling toward the back of the coach.

For More Information

Refer to the product manufacturer's owner's manual and links to learn more about your coach's compartments.

Doors, Handles, and Chimes

Entrance Doors

The front entrance door is equipped with a dead bolt lock for added security, and select coach models may have a power flush step well cover. When the door is opened fully, the door has a "door check" feature that will automatically hold the door open. To close the door, simply pull to release the detent, then close and latch the door. Center entry doors may incorporate a gas strut to hold the door open.

Grab Handles and Chimes

For your safety and convenience, all current models feature a grab handle at the entrance door to assist you in entering and exiting the coach. Select models may incorporate the keyless entry system, and many have a doorbell button integrated into the grab handle as well.

For More Information

Refer to the product manufacturer's owner's manual and links to learn more about your coach's entrance doors, handles, and chimes.

Entrance Steps



IMPORTANT

These brief operation instructions are for quick reference only. Any quick start instructions provided should not take the place of the complete Operation Manual provided by this item's manufacturer.

Electric Step

Your coach may be equipped with electric entrance door steps. When the power switch for the steps is in the ON position, simply open the door, and the steps will open. To operate the electric steps:

1. Turn the step power switch ON.
2. Close the door. The step should retract and close completely.
3. Open the door. The step should extend and open completely.
4. Turn the step power switch OFF. The step should remain in the extended position when the door is closed. Turning off the power with the step retracted will keep the step in a retracted position.
5. With the step extended, turn the step power switch OFF, and close the entrance door.
6. Turn on the vehicle ignition. The ignition override system will turn on, and the step will automatically retract.
7. Turn off the vehicle ignition, and open the door. The step will extend and open completely.

Hydraulic Step

Select coach models may be equipped with hydraulic steps. With the entry door step switch turned on in the front overhead cabinet, this step extends when the door is opened and retracts when the door is closed (as long as the park brake is set). Opening and closing the door will automatically shut down the pump at the end of the step cycle.



NOTICE

It is normal for the pump to run for a short time after the step is retracted.

During deployment, the step will stop if the shin guard or curb feeler is touched by an object. The curb feeler is mounted to the bottom of the lowest step, and the shin guard is mounted to the step face of the lowest step.



CAUTION

Do not sit or stand on the step while the door is being closed, as the step will close when the door switch is activated.



WARNING

Do not sit or stand on the step with the ignition on if the parking brake is going to be released. The step may retract automatically regardless of the door or on /off switch position.

The exterior switch can be turned off once the step is extended. This will prevent the step from opening and closing each time the door is opened or closed. The step will extend one time after it has retracted with the switch in the off position.

For More Information

Refer to the product manufacturer's owner's manual and links to learn more about your coach's entrance steps.

Exterior Lights



IMPORTANT

Always check the operation of all headlights, turn signals, and clearance lights prior to traveling.

Replace any exterior light bulbs or fixtures as needed to maintain DOT requirements and safety.



CAUTION

When replacing any bulbs, do not use a different bulb number, even if the bulb looks the same as the old one. Doing so may cause overheating and damage to the light fixture or lens.

Turn power off to the lights to avoid possible short circuits, blown fuses, and burns while removing and replacing bulbs or lights. Depending on the year and model of your coach, it may be equipped with LED light fixtures with the lights embedded into the light housing. These types of fixtures may require the replacement of the entire light instead of the bulb only. When replacing halogen bulbs, do not touch the bulb, as the oil from your hands will reduce the life of the bulb.

Headlights

The coach may have headlights installed that are atmospherically vented, so condensation may occur in these headlight assemblies. Under normal driving conditions with the headlights turned on, the condensation will dissipate, allowing it to escape through the vent.

Maintenance

It is necessary to keep exterior lights clean, as dirty lights have diminished output and reduced visibility. To clean your exterior lights, use a mild soap designed for automotive car washing. Avoid using harsh cleaners, abrasive products, and petroleum-based products or other chemicals.

For More Information

Refer to the product manufacturer's owner's manual and links to learn more about your coach's exterior lights.

Hitches and Towing Components

Your motorhome is equipped with a hitch and tow plug, as it is designed for towing light loads. Your hitch may provide you with the capability of towing your car or trailer while traveling.

A wiring harness or pigtail is needed to connect tail lights, brake lights, turn lights, etc. of the towed vehicle with that of the coach. Some coach models feature rear docking lights to assist with tow vehicle hookup at night.

Prior to towing, inspect all towing connections, including the hitch mounting bolts for unusual wear or corrosion. Check the mounting flanges for any deformation, as well as the hitch welds for any cracks, signs of movement, or fatigue in the hitch assembly. Safe and satisfactory performance of the towing system depends on the type of towing equipment connected to the hitch receiver. The assembled length of the drawbar/towing system used should be kept to a minimum. Do not exceed the rated capacities of the hitch or the components used to attach the towed vehicle or trailer.



IMPORTANT

Newmar is not responsible for damage or failure of the hitch receiver caused by the use of excessively long drawbars or other styles of drawbars that create leverage loads on the hitch receiver beyond its designed capabilities.

The total weight of the motorhome and any vehicle towed must not exceed the GCWR (Gross Combined Weight Rating). When planning to tow, approaching the GVWR (Gross Vehicle Weight Rating) may reduce the motorhome's towing capacity. When weighing the motorhome, be sure to take passenger locations into consideration. The towed vehicles must have adequate active brakes. Contact your state Department of Transportation or your local Newmar dealer for your state requirements.

For More Information

Refer to the product manufacturer's owner's manual and links to learn more about your coach's hitch and towing components.

Mirrors

Your coach may be equipped with convex remote-controlled two-part exterior rear view mirrors. The top portion of the mirror is flat, providing conventional reflected views down the sides of the RV, while the bottom portion is convex to provide an expanded view, helping to eliminate blind spots. These mirrors may also contain heating elements to defog, defrost, or de-ice the mirror glass during cold weather operation. Some mirrors can be operated via remote control.



IMPORTANT

These brief operation instructions are for quick reference only. Any quick start instructions provided should not take the place of the complete Operation Manual provided by this item's manufacturer.



Always adjust the mirrors for maximum rear visibility prior to driving. These mirrors are adjusted by using the multi-directional switches located on the driver's door (optional on some models) or console. Make sure the seat is positioned for proper vehicle control, and then adjust the mirrors for maximum rear visibility prior to driving. Select the mirror to be adjusted by pointing the arrow in the direction of that mirror. Move the control in the direction of movement desired to obtain the best view.

The ON/OFF switch for this feature is located by the adjustment control. The adjustment control moves the top half of both mirrors. The bottom half of the mirror is convex and is adjusted manually. Use the red switch to turn ON and OFF the heated mirror feature (if equipped).



IMPORTANT

Objects viewed in the convex mirrors are closer than they appear.

For More Information

Refer to the product manufacturer's owner's manual and links to learn more about your coach's mirrors.

Paint, Roof, and Siding

Newmar RV sidewalls are designed with structure to make them more rigid and dependable. By building aluminum frames with studs 16 inches on center, your sidewalls and roof will form a strong, lightweight, integrated structure so you can enjoy superior insulation. The Newmar Full-Paint Masterpiece™ Finish is one of the most stunning and durable in the industry. And it comes standard on every full-paint Newmar model, from our most affordable to our most luxurious.



IMPORTANT

These brief operation instructions are for quick reference only. Any quick start instructions provided should not take the place of the complete Operation Manual provided by this item's manufacturer.

Paint

We're passionate about paint. And we believe that the RV we create for you should be as beautiful as it is comfortable. Our coaches are more gorgeous than ever, with a sleek, stunning exterior showcased by all-new graphics and the exquisite Full-Paint Masterpiece™ Finish. Our goal is to create a perfect finish every time we paint a Newmar. This is how we do it:

- Between 12 and 16 gallons of paint are used on each model.
- Several types of primer are applied, followed by a base coat, color for graphics and a final, clear coat.
- We use materials of only the highest quality and integrity.
- Our technicians are among the most knowledgeable and highly experienced.
- The equipment and techniques we have created are among the most advanced.

We always ensure that each coat of paint lays flat and smooth to produce a stunning brilliance. That's how we can promise that your Newmar RV will offer you an exterior of the highest quality and durability.

For cleaning and waxing instructions and recommended products refer to the Miscellaneous Care and Maintenance section in Newgle.

Diamond Shield Paint Protection

If your coach utilizes a Diamond Shield Paint Protector, follow the use and care guidelines as outlined by Diamond Shield:



IMPORTANT

Once applied, refrain from washing for 48 hours, washing after that time presents no problems. Do NOT use harsh or abrasive cleaners or detergents.

¹ "We do not recommend ANY of the dry wash types of cleaners as they are intended for non-porous surfaces, paint protection films are a porous material. Car wash type soap is recommended. Bugs should be washed off ASAP... Use extreme care if using a pressure washer, too high of a pressure or misuse of pressure washer may cut or tear the film. Pressure washer damage is NOT covered by Diamond Shield's warranty. The application of ANY products over Diamond Shield i.e. vinyl bras, banners, etc. will void the Diamond Shield warranty... Prior to putting coach/vehicle in storage Diamond Shield should be cleaned and waxed... Do not use wax designed for specific colors."

Roof

This unit is manufactured with a 7mm decking material covered with fiberglass or rubber membrane. Proper care and routine maintenance of your roof is necessary for trouble-free performance. Inspection of roof seams and joints should be performed by an Authorized Newmar Service Center annually. For units equipped with roof drains, it is important to make sure the roof drain catch basin strainers are cleaned and kept free of debris. There are four (4) of them, and they are located at the front and rear ends of the roof gutters, on both the left and right sides. Regular cleaning and maintenance is essential to insuring a long, trouble-free life. Before cleaning, it is important that you inspect the sealants and gaskets used to seal components to the roof structure to be certain there is no leakage during the cleaning process. Any cracks or voids in the sealants and seals MUST be repaired prior to spraying the roof with water. Extreme caution should be used when inspecting or cleaning the roof.



WARNING

It is recommended that access, cleaning, and maintenance be conducted by a qualified professional at your local dealership. Use caution if working on top of your vehicle. The wet roof surface is extremely slippery.

Siding

The sidewalls and end caps of your coach are constructed of smooth fiberglass, which is features an automotive style "Clear-Coat / Color Coat" painted finish.

Seals

The seals around doors, windows, vents, slide out trim and external seams should be checked at least twice a year. In addition, the roof seams should be inspected twice a year for cracking or peeling. If deterioration is noted during a routine maintenance inspection, reseal the seams or seals with an approved sealant to prevent leaks. Your dealer can perform the resealing inspections and work for you. It is recommended that a Newmar Authorized Service Center perform these inspections, and reseal when necessary.

Maintenance

Clean the fiberglass material with a mild cleanser and warm water. Use only soft cloths. Using stiff bristle brushes may cause scratches in the fiberglass surface. Please refer to the information provided by the paint manufacturer for more cleaning and maintenance details.



IMPORTANT

Newmar is not responsible for weathering/oxidation of gel-coated surfaces.

For More Information

Refer to the product manufacturer's owner's manual and links to learn more about your coach's paint, roof, and siding.

¹ Material sourced from https://www.diamond-shield.com/images_content/ds_product_care.pdf

Wheelchair Lifts



IMPORTANT

These brief operation instructions are for quick reference only. Any quick start instructions provided should not take the place of the complete Operation Manual provided by this item's manufacturer.

Weight Restrictions

The following labels are examples of the listed capacity for your wheelchair lift. Do not exceed the weight limit posted in your coach for any reason.

⚠ CAUTION

This lift is not intended to be independently operated by an individual occupying a wheelchair or similar conveyance. This lift should only be operated by a capable, qualified attendant who is positioned on the exterior of the vehicle and is clear of the travel path of the lift platform. Do not operate the lift from the inside of the vehicle.

For More Information

Refer to the product manufacturer's owner's manual and links to learn more about your coach's wheelchair lift.



750 lb.
Capacity Lift



1000 lb.
Capacity Lift

Windows

The windows installed in your coach are either single or double pane tinted safety glass. Most current models offer sliding glass windows. A power window may be installed on the driver's side on select models.



IMPORTANT

These brief operation instructions are for quick reference only. Any quick start instructions provided should not take the place of the complete Operation Manual provided by this item's manufacturer.

Emergency Egress Window



There is an emergency exit (egress) window in the bedroom designed to be used as an additional exit in emergency situations. It can be easily identified by the red color of the handle and the red EXIT label.

To open the egress window, lift the red handle(s) or red latch(es) and push outward on the window. Lower the window and secure it with the red handle(s) or red latch(es) to the closed and locked position.

Select Newmar floorplans may have an opening window pane in the egress window for ventilation. To operate the vent, unclip and lower the arm. Then swing the arm 90 degrees, and push out on the arm until the red handle latches. To close the vent, unclip the red handle from the latch by slightly lifting while pushing outward. Once the latch releases, pull the arm in until the window is closed. Rotate the arm 90 degrees until it latches into the closed position.

How to Clean the Windows

Most windows used by Newmar are equipped with sliding screens that can be removed for cleaning.

¹Removing the Screen

Open the window and screen. Press upward on the screen frame top, pushing the frame deeper into its pocket. This will compress the springs and allow the screen frame bottom to rotate out of the bottom track. Be careful with the plastic screen springs, so that they can be re-used.

Cleaning the Glass

Apply straight mineral spirits to a clean, soft cloth and wipe the glass. Dry with a clean cloth. Next, clean the glass again, using a clean cloth with a 50-50 mix of water and a household window cleaner like Windex™ or GlassPlus™. If there is still a residue, remove it with rubbing alcohol and dry.

How to Prevent Window Condensation



IMPORTANT

Since surface condensation within the coach cannot be controlled by the manufacturer, damage caused by condensation is not covered by your Newmar Limited Warranty.

Damage may occur to your unit if excessive condensation exists. Accumulation of condensation on surfaces within your unit occurs when warm, moist air contacts a cool surface. It is most evident on the inside of windows. This problem can be controlled by:

1. Slightly opening a window or roof vent to allow the moisture to escape from the unit.
2. A small dehumidifier is also very effective in removing moisture from the air.

Condensation levels are highest during times when a person is cooking or taking a shower in the unit, but these are not the only times condensation is present. Condensation can migrate through ceiling panels and saturate the fiberglass insulation in your ceiling cavity. This condition often causes the occupants to believe the recreational vehicle has a roof leak. Walls and ceiling panels may also become wet when the moisture accumulates on these surfaces.



IMPORTANT

Newmar Corporation does not recommend the use of any catalytic heaters.

For More Information

Refer to the product manufacturer's owner's manual and links to learn more about your coach's windows.

¹ Material sourced from <http://www.hehrintl.com/pdf/Hehr%20Service%20Manual.pdf>

Windshields

Keeping your windshield clean will provide optimum visibility to view the road ahead. Should you encounter rock chips or cracks, have them fixed by a automotive glass professional immediately to avoid costly windshield replacement. If the crack spreads, replacement may be necessary.



CAUTION

Do not operate the windshield wipers with damaged blades, as they may cause damage to the windshield glass.



NOTICE

Damage to glass by rocks, damaged wipers, or other foreign objects are not warrantable repairs.

For More Information

Refer to the product manufacturer's owner's manual and links to learn more about your coach's windshields.

Wiper Systems

Clean the rubber element every time you fill your gas tank, and remove loose dirt and road grime from the windshield. When washing your coach, use a small amount of non-abrasive glass cleaner on a wet sponge to clean both the windshield and the rubber wiping elements. In colder climates, use an ice scraper to remove snow and ice. Using your wipers to de-ice your windshield can damage the blades, as well as the arm and wiper motor.

Streaking, chattering, and worn blades may be caused by dry rubber that has hardened and cracked. Streaking can also be caused by oil, tree sap, road tar, or other foreign substances on the blade rubber or windshield. Chattering sounds as the blade passes across the windshield are caused by the "deformity" or "curve" in the rubber that some wiper blades develop over time. Worn, damaged, or split rubber around the wiping edge is generally caused by age and use, but may be due to the effects of the sun's ultraviolet rays on the rubber. Damage may also be caused by ice scrapers, automatic car washes, or vandalism. Replace your windshield wiper blades when they become worn or damaged.

For More Information

Refer to the product manufacturer's owner's manual and links to learn more about your coach's wiper system.

HVAC



Let it rain. Let it shine. Inside your Newmar motorhome, you'll be as comfortable as you are in a traditional home — no matter what the weather has in store. Total Comfort Air Conditioning, consisting of two, fully ducted systems that distribute cool air and remove warm air, and various heating systems make climate control simple and effective. This category provides information about your dash, basement, and roof air conditioners, furnace, fans and vents, as well as floor heat, if equipped.

The exclusive Newmar Total Comfort™ air conditioning system comes standard on every Newmar coach, giving you the ultimate in climate control right at your fingertips. Total Comfort. Total Control. All available to you with just the touch of a button. The Total Comfort™ Air Conditioning system is just another way every Newmar RV offers more for enthusiasts just like you.

Both incoming cool air and returning warm air are effectively managed through individual ducting systems to quickly create cold air and efficiently remove warm air. Multiple vents and returns are strategically placed throughout the RV to create a true central air effect.

Under each sub-category, you will have access to owners manuals, user guides, parts and service manuals, and product specifications for each of the HVAC components available in your Newmar coach.

Air Conditioning and Heat, Dash

Dash Control Panel

The dash air conditioning control panel enables the driver to control the temperature, volume, and direction of the air discharged from the heating/air conditioning system. Select coach models may have a driver and passenger control with a switch that allows the driver to override the passenger controls.

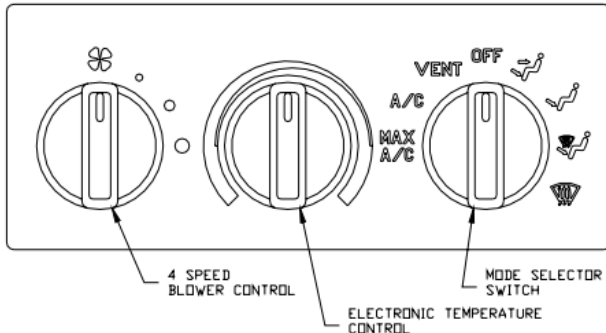

Blower Speed

One of the best ways to control the temperature is by changing the speed of the blower. The blower knob (left of center) provides four speeds in any mode, except when the control is set to OFF.

Temperature Control

The center knob controls the temperature of the discharged air. Turn the knob to the right (red area) for warmer air, and to the left (blue area) for cooler air.

Mode

To achieve the maximum comfort in your coach, the air must be directed where it is needed. The mode switch (right of center) gives the driver the ability to select where the air will flow. The air conditioning system is designed to operate in all modes except VENT, FLOOR, and OFF. This provides significant moisture, dust and pollen removal for enhanced passenger comfort.



IMPORTANT

If the mode knob is in any position other than OFF, the blower is always on a low speed unless a higher speed is selected.

Max A/C

Air is drawn from the passenger compartment and is discharged and recirculated through the dash louvers. This position is used to provide maximum cooling, and is generally used during extremely hot weather conditions for initial cool-down periods. Because this mode does not allow fresh "outside" air into the passenger compartment, it may cause fogging of the windows, and/or stale air, when used for prolonged periods of time. Switch to A/C mode periodically if these conditions occur.

A/C

Outside/fresh air is drawn into the system and discharged through the dash louvers. These louvers can be adjusted for maximum comfort.

Vent

Outside air is drawn into the system and discharged through the dash louvers. For enhanced passenger comfort, upper-level ventilation air is also discharged through the defrost outlets. When outside ambient temperatures are below approximately 40° F, the A/C compressor may cycle rapidly. Use Vent mode instead of A/C in these temperature conditions to cool the interior air temperature.



IMPORTANT

For operational safety in the event of the loss of vacuum, the HVAC system is designed to discharge air through the defrost vents to provide continuous windshield defogging.

Off

The blower motor does not operate in this mode. The fresh air inlet door closes, minimizing outside air infiltration into the vehicle.

Bi-Level

Outside air is drawn into the system and discharged through the dash louvers, floor, and defrost outlets. The A/C system operates in Bi-level mode.

Floor

Outside air is drawn into the system and discharged through the floor outlets. In some models, a small amount of air is directed to the windshield for defrost. The A/C system does not operate while in Floor mode.

Mix

Outside air is drawn into the system and discharged through the floor and defrost outlets. The A/C system operates in Mix mode to provide windshield defogging.

Defrost

Outside air is drawn into the system and discharged through the defrost outlets. The A/C system operates in Defrost mode to provide windshield defogging.

For More Information

Refer to the product manufacturer's owner's manual and links to learn more about your coach's dash air conditioning.

Air Conditioning and Heat Pump, Roof

To use the air conditioner, make sure 120 volt AC power is available to the air conditioner, and turn it on by selecting the mode of operation and the temperature setting using the wall mount thermostat or the appropriate SilverLeaf screen. Some prior coach models may have incorporated the controls in the ceiling package of the air conditioner.

For More Information

Refer to the product manufacturer's owner's manual and links to learn more about your coach's roof air conditioning. More information can also be found by referring to the thermostat section under the HVAC category in Newgle. Most air conditioning systems have a two minute built-in time delay, so there may be a slight delay in the operation of the air conditioner after the thermostat is set.

Fans and Ventilation

Vents operating on 12 volt power may be installed in your coach kitchen and bathroom. Depending on your vent setup, they may be controlled by a switch directly on the vent assembly or the switches located on the wall. Dash fans may

also be installed on or in the front overhead cabinet and aid in windshield defrosting and air circulation in the cockpit area of the coach.

For improved lighting and headroom, a skylight may also be installed in the bathroom over the shower. The opening provides additional light during daylight hours, and the skylight is tinted to provide privacy and reduce glare.

For More Information

Refer to the product manufacturer's owner's manual and links to learn more about your coach's fans and ventilation system.

Hydronic Heating

Hydronic Zone Heating systems make climate control simple and effective.



IMPORTANT

These brief operation instructions are for quick reference only. Any quick start instructions provided should not take the place of the complete Operation Manual provided by this item's manufacturer.

Domestic Hot Water

The hot water in your unit is heated by the Oasis hydronic heating system. Turning the 120 volt heating element on will usually provide sufficient hot water for most household chores. To operate an appliance that uses hot water, or to assure plenty of hot water for showering, turn on the boiler or heating elements using the Oasis control panel or the SilverLeaf touchscreen (if equipped) located in the front overhead cabinet. Both heat sources (boiler and heating elements) can be used at the same time for the desired maximum water heating capability.



WARNING

Use caution when washing the exterior of your vehicle. Water should not be sprayed directly into the furnace vent. If water is forced beyond the rain baffles into the furnace vent, rusting of the furnace could occur. This could also cause improper combustion.

For More Information

Refer to the product manufacturer's owner's manual and links to learn more about your coach's hydronic heating system.

Oasis Hydronic Heating

¹"For your comfort, your coach may be equipped with the Oasis heating system. This system uses a "boiler" and a pump to heat and recirculate hot fluid through a series of convectors placed strategically throughout your unit. Fans located on the convectors provide circulation of the warmed air for more even, efficient heating."

How it Works

"Hydronic central heating is the use of a heat generator commonly called a boiler (or furnace) to raise the temperature of a heating medium, generally water or water and glycol mixture. The heated fluid is then circulated from the boiler through pipes to heat emitters such as passive radiators, convectors and underfloor heating coils, through the interior of the motorhome, and domestic hot water heat exchanger. The fluid loses its heat through this circulation and the cooler fluid then returns to the boiler for reheating."



IMPORTANT

These brief operation instructions are for quick reference only. Any quick start instructions provided should not take the place of the complete Operation Manual provided by this item's manufacturer.



WARNING

Never attempt to modify this furnace. Fire, explosion, asphyxiation, or carbon monoxide poisoning may occur. If the furnace malfunctions, consult a trained service technician.

The Oasis system uses two different sources for heat. The primary heat source for the Oasis system, and most efficient, is the diesel burner, which uses diesel fuel from the fuel tank to burn and create heat. The output of the diesel burner is 50,000 BTU's.

The second heat source is an electric heating element. It is important to note the difference in the two systems. The electric heating element has a 5000 BTU output and should be used only to help maintain the temperature once the diesel burner has brought the system up to proper operating heat levels. From a cold start, the 5000 watt electrical heating element will not operate the system alone.

For heating, your unit is divided into three "zones" on your thermostat or your climate screen, if your coach is equipped with the SilverLeaf system. The "Furnace" mode will appear in all four zones, but only three are active.

Zone 1 - Dash, Living Room, and Kitchen Convector

These convectors are located under the dash and kitchen cabinets, and control heat in the cockpit, living room, and kitchen areas. The dash mounted convector is the only one in your unit that has a two speed fan. The switch controlling the fan speed is located in the front overhead cabinet adjacent to the diesel boiler switch.

Zone 2 - Middle AC and Heat Pump

There are no Oasis functions on this zone.

Zone 3 - Bathroom Convector

These convectors are located in the bathroom cabinetry and stool room. The fan switch for the stool room (marked "HEAT") must be in the "ON" position to provide heat in the stool room. In order to receive heat in the Stool Room, a "rear" zone (bathroom or bedroom areas) must be chosen on your thermostat or your climate screen, if your coach is equipped with the SilverLeaf system.

Zone 4 - Bedroom Convector

These convectors are located throughout the cabinetry and walls of the rear bedroom area. To activate the Oasis heating system, select your heat source, either diesel or electric, using the switches in the front overhead cabinet or through the SilverLeaf system. Once you have selected a heat source (diesel or electric), and the boiler is operational, set thermostat for the desired zones.



NOTICE

For more information about your Comfort Control system, please refer to the Thermostat sub-category or the Climate Control section within the SilverLeaf Functional Guide in Newgle.



IMPORTANT

The Oasis 'diesel burner' heat source provides approximately 50,000 BTU's of heat, and is designed to start and operate the system at full capacity. The electrical heating element provides approximately 5000 BTU's of heat.

The system will turn convector fans off and on according to the temperature settings.

Resetting the Oasis System



IMPORTANT

In the event of a fault in the Oasis system, the system will need to be reset.

To reset the Oasis system, press the exterior reset button on the face of the Oasis, or turn the burner switch off, then back on inside the coach. The reset will clear faults such as Low Voltage, Flame Out, or a Low Fluid Level switch fault, which typically clears on its own when the fluid level becomes sufficient. The Oasis will try to start twice when there is a Flame Out fault. When it fails to start the second time, it will then display a fault on the face of the Oasis and on the System Diagnostics screen within the SilverLeaf system (if equipped).



IMPORTANT

The exterior reset or the cycling of the ON/OFF button inside the coach will not reset the system if there is a component fault, like a pump or other internal issues.



CAUTION

Any faults not resettable by cycling the switch or by the Oasis reset button should be diagnosed and repaired by a qualified technician.

¹ Material sourced from <http://itrheat.com/products/oasis-heating-system/system-resources/frequently-asked-questions/>

Radiant Heating

The floor heat uses a heat mat placed between the tile and the floor structure. A controller regulates the temperature and the timed heat cycles depending on the controls set up for your system. The floor heat operates on 120 volt AC power.

For More Information

Refer to the product manufacturer's owner's manual and links to learn more about your coach's radiant heating system. If your coach is equipped with the SilverLeaf coach management system, refer to the SilverLeaf functional guide for more information about the function and operation of the floor heat via the SilverLeaf touchscreen.

Thermostats



IMPORTANT

These brief operation instructions are for quick reference only. Any quick start instructions provided should not take the place of the complete Operation Manual provided by this item's manufacturer.

Operating Controls

Set Clock Button

Pressing the CLOCK button will cause the HOURS setting to flash, allowing you to adjust the HOUR value using the up

Operating Controls

Set Clock Button

Pressing the CLOCK button will cause the HOURS setting to flash, allowing you to adjust the HOUR value using the up and down arrows. Pressing the clock button a second time will cause the MINUTES setting to flash, allowing you to adjust the MINUTES value using the up and down arrows. Pressing the clock button a third time will set the time, and promptly exits out of the clock-setting mode.

Temp Format Button

Pressing the *F/*C button will allow you to choose between the Fahrenheit or Celsius settings.

Mode Selection Button

Pressing the MODE button allows you to choose between various options, depending on the system installed in your coach. Choices may include the following:

- OFF = off
- COOL = setting for air conditioning
- AUTO = allows the thermostat to determine to use one of the heating options or cooling option to maintain a set temperature
- HP = heat pump setting to use A/C to heat instead of cool
- FURN = furnace setting to use the furnace for heating
- AQUA = coaches with Aqua Hot heating systems for heat instead of a furnace
- HS = heat strip (Newmar does not use this function, so it is likely that this option will not show up on the thermostat; however, if the dip switch for the heat strip is turned on, it will appear)
- FAN = fan only allows you to use the fan to move air without heating or cooling

Zone Button

Pressing the ZONE button allows you to select which zone to control.

Temperature Set Point

After selecting the zone and mode, this button allows you to determine the desired temperature by using the up and down arrows.

Fan Button

Pressing the FAN button allows you to select the Auto (automatic fan selection) or manual setting of fan, as well as the fan speed (HIGH, MED, LOW).

For More Information

Refer to the product manufacturer's owner's manual and links to learn more about your coach's thermostat.

Interior



Amish craftsmanship and elegance in design meld the wood cabinetry and furniture seamlessly with the Newmar interior. Flooring, both tile and carpet, is installed with Newmar's own in-house process, ensuring the best in quality and longevity, as well as the finest fit. This category provides detailed information about your furniture, cabinetry, flooring, fabrics, window coverings, and all of the interior accessories that make your coach into a home.

Under each sub-category, you will have access to owners manuals, user guides, and product specifications for each of the interior components and furnishings available in your Newmar coach.

Beds and Mattresses

Several styles and sizes of beds and mattresses are available depending on your coach floorplan, such as pillow top and air mattresses. Your bed platform lifts to provide an additional convenient storage area. A strap may be provided to help raise the lid of bed base and is held open by pressurized struts to allow hands-free access. Select coach models may also be equipped with flip-down bunks or bunk bed lifts.

Coaches equipped with bunk beds may have labels adhered to a surrounding area to provide special instructions or weight capacities. Acknowledge and follow all warning labels to prevent any damage to equipment or personal injury. The following labels are examples only. Actual instructions and weight restrictions may vary.

⚠ WARNING

To help prevent serious or fatal injuries from entrapment or falls:

- Never allow a child under 6 years on upper bunk
- Use only a mattress that is _____ inches long and _____ inches wide on upper bunk
- Ensure thickness of mattress and foundation combined does not exceed _____ inches and that mattress surface is at least 5 inches below upper edge of guardrails

DO NOT REMOVE THIS LABEL

**Max Weight
150 LBS**

**Bunk To Be
Used For
Sleeping Only**

WARNING

On coaches equipped with a flip-down bunk or bunk bed lifts, **NEVER** operate the bed(s) with person(s) or object(s) on the bed platform or travel with any object(s) other than bedding on the beds.

For More Information

Refer to the product manufacturer's owner's manual and links to learn more about your coach's beds and mattresses.

Cabinetry and Woodwork

Newmar's exquisitely crafted cabinetry newly gleams with chrome-finished hardware, the perfect complement to the array of appliances that make cooking and clean-up a breeze. Amish craftsmanship and elegance in design meld the wood cabinetry and furniture seamlessly with the Newmar interior. All Newmar cabinetry is custom built in our facility and designed with function and convenience in mind, as well as to provide as much storage as possible in your coach.

All joints on Newmar hardwood cabinets are glued, and then screwed together for extra durability. Hardwood raised panel cabinet doors are standard throughout the coach. Depending on your coach model, you may have hardwood cabinets or vinyl veneer finished cabinets. A variety of vinyl veneer and stain finishes are available for the cabinetry. A hand-sanded finish helps minimize seams so your hardwood cabinetry is as beautiful as it is durable.

Cabinetry Features

Metal drawer guides provide a smooth opening and closing of the drawers in your coach. To open a drawer, lift up slightly and pull open. This feature helps prevent the drawers from opening during transit. Your unit may also include features such as adjustable pull out pantry boxes in the kitchen or a molded silverware divider tray for added storage.

Kitchen Extensions or Islands

Your unit may be equipped with an optional pull out Kitchen Extension or Kitchen Island. The “extension” is incorporated directly into the kitchen cabinetry, and glides out on drawer guides to provide additional counter space when needed. On 2017 and newer coaches, press the push button switch right above the pull-out island to release the island extension. On older coaches, unlock the extension by accessing the lever located in the top drawer.

If your unit is equipped with an optional pull out “island,” the cabinet will pull completely free of the kitchen cabinetry and can be moved throughout the unit on the attached casters. When storing the island, it will roll back over a stop, and the front caster locks will inhibit their movement.



WARNING

The optional pull out kitchen extension/island **MUST** be secured back into their stored position in the kitchen cabinetry prior to travel. Failure to lock the island or extension prior to transit can cause damage to the cabinetry and interior of your unit, and under certain circumstances, injury or death.

Pull Out Bathroom Step

The bathroom may feature a pull out step or storage bin in the bottom of the lavatory cabinet. This convenient step provides younger children with better access to the sink and mirror. The hinged top provides a platform on which they can stand, while still allowing for storage underneath.

Care and Maintenance

Controlling the coach environment is the first priority of cabinet care and maintenance. Wood products shrink and grow according to the environment in which they are placed. These changes are in direct relationship to the relative humidity levels. As the humidity increases, the wood expands, and as the humidity decreases, the wood shrinks. This process does not happen instantaneously, as the longer the wood is exposed to low humidity, the more it will shrink as it dries out, and visa versa.

Coach owners who travel around the country may be more prone to this issue, as their coach is exposed to both extreme humidity and extreme dryness. It is necessary to acknowledge the fact that wood changes according its environment. Newmar recommends maintaining relative humidity levels between the range of 35-50 percent and temperature levels between the range of 40-90 degrees. The air conditioner or a dehumidifier will reduce the humidity level; however in dry climates, a humidifier may also aid in maintaining the appropriate humidity levels by raising the humidity level.



IMPORTANT

Hardwoods may change color or darken when exposed to sunlight. It is important that the window shades be down during long periods of storage. Changing shades of color, or discoloration, from exposure to sunlight is not a warrantable repair, as it is the nature of the hardwood products in your coach.

The wood cabinetry should be dusted and wiped down with furniture polish as needed to sustain the natural beauty and luster of the wood.



IMPORTANT

As with any wood product, do not saturate these cabinets with water or any other liquid. Be sure to wipe up spills as they occur to avoid staining.

Ceiling

The ceiling in your coach may be covered with a padded vinyl ceiling headliner.

Care and Maintenance

The ceiling coverings should be cleaned periodically to maintain a new appearance. Use a non-abrasive cleaner with a soft cloth. Do not use solvents of any kind, as they may damage the surface.

IMPORTANT NOTICE

Certain of our forest product suppliers have advised that urea-formaldehyde is used in the production of particle board, hardwood plywood or paneling which they supply us and which we utilize in our finish product. These suppliers have requested that we communicate this to our customers.

For your information, we are reproducing samples of statements which have been provided to us by our suppliers.

WARNING: THIS PRODUCT CONTAINS A UREA-FORMALDEHYDE RESIN AND MAY RELEASE FORMALDEHYDE VAPORS IN LOW CONCENTRATIONS. FORMALDEHYDE CAN BE IRRITATING TO THE EYES AND UPPER RESPIRATORY SYSTEM OF ESPECIALLY SUSCEPTIBLE PERSONS SUCH AS THOSE WITH ALLERGIES OR RESPIRATORY AILMENTS. PROPER VENTILATION SHOULD REDUCE THE RISK OF SUCH PROBLEMS. IF SYMPTOMS DEVELOP, CONSULT YOUR PHYSICIAN.
Adorn, Inc.

WARNING: IRRITANT: THIS PRODUCT CONTAINS A UREA-FORMALDEHYDE RESIN AND MAY RELEASE FORMALDEHYDE VAPORS IN LOW CONCENTRATIONS. FORMALDEHYDE CAN BE IRRITATING TO THE EYES AND UPPER RESPIRATORY SYSTEM OF ESPECIALLY SUSCEPTIBLE PERSONS SUCH AS THOSE WITH ALLERGIES OR RESPIRATORY AILMENTS. PROPER VENTILATION SHOULD REDUCE THE RISK OF SUCH PROBLEMS. IF SYMPTOMS DEVELOP, CONSULT YOUR PHYSICIAN.
Woodbridge, Inc.

WARNING: THIS PRODUCT CONTAINS A UREA-FORMALDEHYDE RESIN AND MAY RELEASE FORMALDEHYDE VAPORS IN LOW CONCENTRATIONS. FORMALDEHYDE VAPOR MAY, IN SOME PEOPLE, CAUSE HEADACHES, EYE, NOSE, AND THROAT IRRITATION AND AGGRAVATION OF ALLERGIES AND RESPIRATORY PROBLEMS, SUCH AS ASTHMA. PROPER VENTILATION SHOULD REDUCE THE RISK OF SUCH PROBLEMS.
Robert Weed Plywood Corp

Ventilation is important in maintaining a comfortable environment and we direct your attention to the discussion of ventilation contained in your Owner's Manual.

Urea-formaldehyde is used in the production of particle board, hardwood plywood, and most paneling. Urea-formaldehyde resin may release formaldehyde vapors into the air, which may cause headaches, and in some people, eye, nose and throat irritation. Formaldehyde may intensify some allergies or upper respiratory problems like asthma. Providing proper ventilation as needed by operating the power roof vents and opening windows should reduce the risk of such problems.

For More Information

Refer to the product manufacturer's owner's manual and links to learn more about your coach's ceiling.

Countertops

Currently all Newmar products feature solid surface countertops. The year and model of the coach determine the finish on the solid surface countertops. Model features may vary from polished solid surface countertops in the kitchen, matte finishes in bathroom and bedroom to high-polished surfaces throughout the coach.



IMPORTANT

These brief operation instructions are for quick reference only. Any quick start instructions provided should not take the place of the complete Operation Manual provided by this item's manufacturer.

The solid surface composite countertops can be cleaned with soap and mild detergents, which will remove most stains. DO NOT use products containing bleach and other strong chemicals. Most scratches can be sanded out and defects in solid surface countertops can be repaired by trained professionals without replacement.

Maintenance



IMPORTANT

To properly care for the countertop in your coach, always use a heat pad or trivet to protect the surface from hot objects that may mar or damage the surface. Also avoid cutting directly on the surface and using harsh chemicals on the counter top.

To clean, wipe with a damp cloth and for "dried on" spots or rings, wipe with a damp cloth and a mild liquid soap. Strong chemicals and solvents may damage the surface and should be wiped up immediately, then rinsed with water.

For More Information

Refer to the product manufacturer's owner's manual and links to learn more about your coach's countertops.

Fabrics and Interior Furnishings

Newmar uses only the most highly regarded names in residential décor to make their finest luxury coach a reality. High-quality fabrics are used throughout your coach, including the bedspread, shams, accent pillows, draperies, headboard, valances, and much more.



IMPORTANT

These brief instructions are for quick reference only. Any quick start instructions provided should not take the place of the complete Manual provided by this item's manufacturer.

Fabric Maintenance

The fabrics used in your coach may contain fire-retardant additives that may be damaged by use of improper cleaning products. Cleaning instructions for these items are DRY CLEAN ONLY. Water-based products are not recommended for cleaning the fabrics in your new unit. Most water-based household cleaning products are not formulated for use on these fabrics and may cause excessive shrinkage or fading. For best results, the fabrics in this unit should be cleaned by a professional carpet and upholstery cleaner.

Spills, spots, or stains should be treated as soon as possible to avoid permanent damage. If a spill occurs, blot the fluid with a dry towel. Do not rub the spill. Rubbing may cause the liquid to “set” in the fabric. When attempting to clean a spot or stain, always start from the outside and work inward to avoid spreading it further.



IMPORTANT

Some stains or soils are extremely difficult or impossible to be removed completely. These should receive immediate, professional attention. Spills, spots, stains or soils are the responsibility of the owner, and are not covered by the Newmar Limited Warranty.



WARNING

When cleaning the upholstery and fabric in the unit, do not use lacquer thinner, nail polish remover, laundry soaps, or bleach. Never use carbon tetrachloride or gasoline for cleaning purposes. These items may cause damage to the materials being cleaned, and most are highly flammable.



IMPORTANT

The fading of upholstery, carpet and other interior fabrics can be caused by excessive sunlight. The drapes, blinds, or shades should be kept closed if the coach will be parked for an extended period of time to minimize fading. Normal deterioration due to wear and/or exposure to sunlight is not covered by the Newmar Limited Warranty.

For More Information

Refer to the product manufacturer's owner's manual and links to learn more about your coach's interior furnishings.

Flooring

Flooring – both tile and carpet – is installed with Newmar's own in-house process, ensuring the best in quality and longevity, as well as the finest fit. The flooring in every Newmar coach — from our high-quality, durable tile to the plush, luxurious carpeting— is placed with the highest level of care.

Tile Maintenance

As needed, sweep your floor to remove dirt and grit. Wipe up any spills promptly. Damp mop once a week (or more often for heavy traffic areas) using a tile cleaner. Use a neutral pH cleaner compatible with grout cleaning.



IMPORTANT

Never use detergent, soap or other harsh, which can dull the surface or promote mildew growth. Cleaners should never contain acids, vinegar, chlorine, or ammonia, as these chemicals can damage and discolor both the grout and the stone or tile.

Carpet Maintenance

The installed carpeting is made of synthetic materials, mostly nylon fiber and is easy to maintain. Vacuum regularly to remove dirt, dust, lint, and other abrasive grit. Water-based spills and spots should be soaked up and removed immediately with a damp cloth. Grease or oil based stains and spots should be spot cleaned with a commercial spot cleaner intended for this purpose. When complete shampooing is desired or necessary, it is best to have it done by a professional carpet cleaner. Wait for the carpeting to dry thoroughly before walking on it.



IMPORTANT

Do not soak or water-log your carpeting.

Carpet Maintenance

The Carpet Care Guide lists detailed information on cleaning soiled areas and removing stains from the carpet installed in the unit. This information will be helpful in maintaining and extending the life of the carpet. Please refer to this information for the carpet care and cleaning instructions. Simple vacuuming is all that is necessary to remove loose dirt and debris for everyday cleaning. A weekly routine of vacuuming the carpet and fabrics throughout the vehicle is recommended. Vacuuming will prevent an accumulation of dirt that can detract from the materials appearance and shorten its life. Remember to empty or replace vacuum bags before they become half full.



IMPORTANT

In carpet areas that receive the most sunlight, close the curtains frequently to prevent fading.



IMPORTANT

Act quickly to clean up when anything is spilled or dropped on the carpet.

Vinyl Flooring Maintenance

For routine cleaning, sweep or vacuum regularly. Then, use a damp mop with warm water to clean a small area at a time. Rinse the mop frequently as to not redistribute the picked up dirt. If washing is needed, use a product designed for no-wax flooring.



IMPORTANT

Do not use solvent-based waxes or polishes, as damage to the flooring may result.

Laminate Flooring Maintenance

Sweep or vacuum regularly using a broom or the wand attachment on your vacuum cleaner. Clean your laminate floor occasionally using a damp mop and a laminate floor cleaner. Allow it to dry thoroughly. Clean up any spills, mud, and other liquid/moisture sources immediately.



IMPORTANT

Do not use abrasive cleaners, wax, or harsh detergents on your laminate flooring.

Plank Flooring Maintenance

The simulated plank flooring should be protected from dents, scratches and nicks by installing protective pads on the bottom of chairs and tables. Use of area rugs and floor mats by the entrance door is recommended to trap dirt.

To clean the flooring, begin by vacuuming the floor to remove loose dust and dirt. Then, damp mop the floor with one ounce of Wilsonart Flooring Cleaner diluted in one gallon of clean, warm water (or use a non-abrasive, soap-free cleaner). The mop should be damp, not dripping.



IMPORTANT

Do not use soap-based cleaners, scouring powders, steel wool, abrasive cleaners, wax or polish on the floor.

To remove stubborn spots like shoe polish, oil, tar, markers, scuffs, etc., use a household solvent, acetone or nail polish remover, then wipe with a damp cloth. To remove chocolate, grease, juice or wine, use warm water and a non-abrasive cleaner. To remove candle wax or chewing gum, carefully scrape off when the material has hardened.

For More Information

Refer to the product manufacturer's owner's manual and links to learn more about your coach's flooring.

Furniture

Covered in coordinating fabrics and accented with pillows, a variety of furniture is available in your coach. Options may include recliners, sofa beds, dinettes, and booths. Your furniture is designed with function and design in mind.

Booth Dinette or Dinette Table

Your kitchen may be equipped with either a booth dinette and table or a free-standing dinette table. If equipped, the "hidden leaf" table allows you to add more room to your table top when desired. Two fixed chairs and two folding chairs accompany this table. The chair seats and backs are designed with a coordinating upholstery fabric to match your decor.

A combination desk/dinette table may also be an optional feature in the kitchen area, depending on the floorplan of your unit.

**THE SLEEP FUNCTION
OF THIS DINETTE
HAS BEEN DISABLED
BY THE FACTORY**

Depending on the floorplan of your unit, a built-in dinette booth may be an option. The dinette provides added storage under the seating area of the booth, along with an extra sleeping area. The sleeping area is created by lowering the table top and arranging the cushions. This feature is not relevant to all coaches. On coaches with the booth dinette, seatbelts are mounted to allow forward facing passengers to occupy these positions during transit.



IMPORTANT

Not all seats are equipped properly for occupancy during transit.
These seats will be labeled accordingly.

THIS SEAT NOT FOR
OCCUPANCY WHILE
VEHICLE IS IN MOTION

AD-09W

"CE SIÈGE N'EST PAS DESTINÉ
À ÊTRE OCCUPÉ LORSQUE LE
VÉHICULE EST EN MOUVEMENT."

AD-09F

Driver and Passenger Seats

⚠ WARNING

Be sure that driver's seat is in the forward position before activating the slide out room.

NI-043

The driver and passenger seats are covered in vinyl or leather and may feature six-way power position adjustment. The base moves the chairs forward and backward, as well as up, down, and reverse tilt. The seats have a three-point seat belt, along with swivel and recline features.

When the unit is not in motion, the seats can be swiveled to face the living room of the unit via a release lever on the pedestal. Before turning the chairs, follow this procedure:

- First extend the slideout room.
- Tilt the steering wheel up and toward the dash.
- Reposition the seat to provide enough clearance for the steering wheel.

Once these steps are completed, the chairs will swivel without interference.

Power Seat Operation

The driver and passenger front seats are mounted on power pedestals that offer a wide range of adjustments. The center "joystick" switch moves the seat horizontally and vertically. The front rocker switch tilts the front of the seat up and down. The first rocker switch controls the tilt of the rear of the seat base. Additional switches, depending on the coach year and model, control the recline angle of the seat back.

Lumbar Support

Depending on the coach model and year, the driver and passenger seats may also be equipped with an inflatable lumbar support in the lower back region of the seat and a passenger footrest. The power lumbar control switch is located on the left-hand side in front of the power base controls. Pushing the switch forward will inflate the support. Pushing the switch backward will deflate the support.

Power Foot Rest

The switch with arrows pointing forward and backward controls the foot rest (if equipped). Push the switch forward to extend the foot rest and backward to retract the foot rest.

Troubleshooting

If you experience issues with your power seats, please refer to the Fuse Panel sub-category under Electrical. Select your coach year and model, and then floorplan, to view fuse location diagrams. These will often prove to be helpful when locating your fuse panels, positions, and ratings.

For More Information

Refer to the product manufacturer's owner's manual and links to learn more about your coach's furniture.

Interior Doors and Hardware

The interior doors add to the beauty and privacy of your coach. Newmar installs a variety of functional doors from the basic hinged-swinging door, recessed hardwood pocket doors, and even pivoting doors on select floorplans. Each interior door is designed to fit and function for trouble-free operation.



IMPORTANT

Always secure all interior doors prior to travel to prevent damage to the doors and any surrounding objects.

Care and Maintenance

Controlling the coach environment is the first priority of cabinet care and maintenance. Wood products shrink and grow according to the environment in which they are placed. These changes are in direct relationship to the relative humidity levels. As the humidity increases, the wood expands, and as the humidity decreases, the wood shrinks. This process does not happen instantaneously, as the longer the wood is exposed to low humidity, the more it will shrink as it dries out, and visa versa.

Coach owners who travel around the country may be more prone to this issue, as their coach is exposed to both extreme humidity and extreme dryness. It is necessary to acknowledge the fact that wood changes according its environment. Newmar recommends maintaining relative humidity levels between the range of 35-50 percent and temperature levels between the range of 40-90 degrees. The air conditioner or a dehumidifier will reduce the humidity level; however in dry climates, a humidifier may also aid in maintaining the appropriate humidity levels by raising the humidity level.



IMPORTANT

Hardwoods may change color or darken when exposed to sunlight. It is important that the window shades be down during long periods of storage. Changing shades of color, or discoloration, from exposure to sunlight is not a warrantable repair, as it is the nature of the hardwood products in your coach.

The wood cabinetry should be dusted and wiped down with furniture polish as needed to sustain the natural beauty and luster of the wood.



IMPORTANT

As with any wood product, do not saturate these cabinets with water or any other liquid. Be sure to wipe up spills as they occur to avoid staining.

Interior Steps and Step Covers

On select coaches, the switch for the interior step cover is located either on the side of the passenger console or on the dash console near the center. This cover allows you to freely walk inside of the coach without having to be on the steps while in transit or when parked for longer periods of time. In addition, select coaches are equipped with step treads that can be lifted for additional storage.

Maintaining Your Steps

For safety purposes, keep your steps clear of debris and other personal objects.

For More Information

Refer to the product manufacturer's owner's manual and links to learn more about your coach's interior steps and step covers.

Shades and Window Coverings

Experience as much – or as little – of the outdoors as you want in comfort and style. The window treatments throughout your coach may consist of pleated window shades and lambrequins, curtains, or mini-blinds.



IMPORTANT

These brief operation instructions are for quick reference only. Any quick start instructions provided should not take the place of the complete Operation Manual provided by this item's manufacturer.

Day and Night Shades

The first section visible when closing the shade is the “DAY” section. This material is translucent. Sunlight passes easily through the material into the unit while allowing a degree of privacy. These shades may be power operated via the touch buttons located throughout the coach.

The second visible section is the “NIGHT” section. This material is a heavier, more opaque material. Very little to no light passes through it, so these shades are generally used in the evening or when more privacy is desired, though under certain light conditions, it can cast shadows and silhouettes. These shades may also be power operated via the touch buttons located throughout the coach.

Mini-Blinds

The kitchen window is equipped with a mini-blind. Turn the wand to open and close the slats. Use the strings to lift or lower the blinds.



IMPORTANT

Make sure the blind is unclipped at the bottom before lifting it using the strings.

Curtains

All curtains are dry clean only. Water-based products are not recommended for cleaning fabrics, as they may cause excessive shrinkage or fading.



IMPORTANT

The drapes, blinds, or shades should be kept closed when the vehicle is parked for an extended period of time to minimize fading. Deterioration of appearance due to wear and/or exposure is not covered by the Newmar Limited Warranty.

For More Information

Refer to the product manufacturer's owner's manual and links to learn more about your coach's shades and window coverings.

Walls

Care and Maintenance

The decorative wall coverings can easily be maintained and are not much different from wallpaper that you may have in your home. The wall coverings should be cleaned with a solution of mild soap and water or a non-abrasive cleaner with a soft cloth.



For stubborn spots, test any cleaner on a area that is hidden, as some cleaners may fade or discolor the wall covering. Do not use solvents of any kind, as they may damage the surface.

IMPORTANT NOTICE

Certain of our forest product suppliers have advised that urea-formaldehyde is used in the production of particle board, hardwood plywood or paneling which they supply us and which we utilize in our finish product. These suppliers have requested that we communicate this to our customers.

For your information, we are reproducing samples of statements which have been provided to us by our suppliers.

WARNING: THIS PRODUCT CONTAINS A UREA-FORMALDEHYDE RESIN AND MAY RELEASE FORMALDEHYDE VAPORS IN LOW CONCENTRATIONS. FORMALDEHYDE CAN BE IRRITATING TO THE EYES AND UPPER RESPIRATORY SYSTEM OF ESPECIALLY SUSCEPTIBLE PERSONS SUCH AS THOSE WITH ALLERGIES OR RESPIRATORY AILMENTS. PROPER VENTILATION SHOULD REDUCE THE RISK OF SUCH PROBLEMS. IF SYMPTOMS DEVELOP, CONSULT YOUR PHYSICIAN.

Adorn, Inc.

WARNING: IRRITANT: THIS PRODUCT CONTAINS A UREA-FORMALDEHYDE RESIN AND MAY RELEASE FORMALDEHYDE VAPORS IN LOW CONCENTRATIONS. FORMALDEHYDE CAN BE IRRITATING TO THE EYES AND UPPER RESPIRATORY SYSTEM OF ESPECIALLY SUSCEPTIBLE PERSONS SUCH AS THOSE WITH ALLERGIES OR RESPIRATORY AILMENTS. PROPER VENTILATION SHOULD REDUCE THE RISK OF SUCH PROBLEMS. IF SYMPTOMS DEVELOP, CONSULT YOUR PHYSICIAN.

Woodbridge, Inc.

WARNING: THIS PRODUCT CONTAINS A UREA-FORMALDEHYDE RESIN AND MAY RELEASE FORMALDEHYDE VAPORS IN LOW CONCENTRATIONS. FORMALDEHYDE VAPOR MAY, IN SOME PEOPLE, CAUSE HEADACHES, EYE, NOSE, AND THROAT IRRITATION AND AGGRAVATION OF ALLERGIES AND RESPIRATORY PROBLEMS, SUCH AS ASTHMA. PROPER VENTILATION SHOULD REDUCE THE RISK OF SUCH PROBLEMS.

Robert Weed Plywood Corp

Ventilation is important in maintaining a comfortable environment and we direct your attention to the discussion of ventilation contained in your Owner's Manual.

Urea-formaldehyde is used in the production of particle board, hardwood plywood, and most paneling. Urea-formaldehyde resin may release formaldehyde vapors into the air, which may cause headaches, and in some people, eye, nose and throat irritation. Formaldehyde may intensify some allergies or upper respiratory problems like asthma. Providing proper ventilation as needed by operating the power roof vents and opening windows should reduce the risk of such problems.

For More Information

Refer to the product manufacturer's owner's manual and links to learn more about your coach's walls.

Plumbing



Even your coach's plumbing system proves that the comfort and reliability of home are never far away. This category provides detailed information about your faucets, sinks, and toilets, as well as your holding tanks and water pump. Under each sub-category, you will have access to owners manuals, user guides, parts and service manuals, and product specifications for each of the plumbing components available in your Newmar coach.



Read and understand all operating instructions for the plumbing system prior to using your unit. Failure to connect and operate the system correctly may result in damage not covered by the Newmar Limited Warranty.

Ease of operation was the key element in the design of the water compartment and plumbing in your unit. The fresh water system in your coach is designed to operate at a maximum of 60 PSI. Water pressure levels above this level can damage the fresh water plumbing in your unit. If your water pressure ever surpasses 60 PSI, you must install a pressure regulator to reduce the incoming pressure, or fill the fresh water tank and use the internal water pump to supply water to your coach.

Bathroom Faucets and Fixtures

The faucet in the bathroom is stylish with a durable finish. The tub faucet with shower head, hose and bracket have coordinating finishes complimenting other fixtures in the coach.

Maintenance

The faucets can be cleaned by wiping with a soft, damp cloth. Avoid using "S.O.S." type cleaning pads or other abrasive cleaners because they may scratch the surface. Washing with warm water will remove dry water spots. Do not use cleaners that contain harsh or abrasive chemicals. Alcohol or similar solvents should never be used.

For More Information

Refer to the product manufacturer's owner's manual and links to learn more about your coach's bathroom faucets and fixtures.

Filters

Your coach may be equipped with a fresh water filtration system. This system uses extruded carbon filter cartridges to remove sediment and certain impurities from the incoming water supply. The filter assembly is located in the basement water compartment. Select coach models may also have additional filters installed for drinking water.



These brief operation instructions are for quick reference only. Any quick start instructions provided should not take the place of the complete Operation Manual provided by this item's manufacturer.

How to Replace the Filter

Replacement filter cartridges are available through your Authorized Newmar Dealer.

1. To replace the filter cartridge, turn off the water supply to the coach at the city water connection.
2. Unscrew the filter canister by rotating it clockwise.
3. Insert the new filter cartridge, positioning it so the opening in the bottom of the filter is placed on the molded ring at the bottom of the canister.



When replacing the filter, make sure the rubber O-Ring seal is properly positioned in its groove in the cartridge housing. An improperly positioned or missing seal will cause leakage around the perimeter of the filter housing.

4. Reattach the canister to the filter housing by rotating the canister in a counter clockwise direction. Do not over tighten the canister when attaching it back to the housing.



Do not allow water to freeze in the water filter canister. Freezing will crack and permanently damage the filter housing and associated plumbing. Always remove the filter cartridge prior to winterization.

When to Replace Your Filters

Most water filter manufacturers recommend that you replace your water filters every six months. These guidelines are based more on average household size and average consumption rates rather than your specific coach. The frequency of filter changes depends upon your water usage and the quality of water you are using. As you travel and hook up to different water sources some may contain more sediment, metals, sulfur and other impurities which affect the filter life, the taste and smell of your water. Other factors are how often it is used and stored and how long water is able to sit in the holding tank and become warm and stagnate.

Change the filter at least every six months and at any time you notice decreased water flow or notice unpleasant taste, odor, or algae after flushing and sanitizing the water system. Water filters and fresh water system maintenance are the customer's responsibility in order to ensure safe potable water.

For More Information

Refer to the product manufacturer's owner's manual and links to learn more about your coach's filters.

Fresh Water System

The Fresh Water System consists of the fresh water holding tank, water pump, valves, connection hoses, and fresh water plumbing lines. This system is responsible for providing potable water for drinking, cooking, bathing, and all other activities that require clean water. The capacity of your fresh water tank may vary, depending on the coach model and year.



These brief operation instructions are for quick reference only. Any quick start instructions provided should not take the place of the complete Operation Manual provided by this item's manufacturer.

Fresh Water Tank

WARNING

Potable water only. Sanitize, flush, and drain water tank before using. See owner's manual for instructions, care, and maintenance information. Failure to maintain tank can result in death or serious injury.

AD-04

This tank is used to hold fresh potable water for use throughout the water system. The fresh water tank is filled from the city water hook-up. The valve located in the service compartment near the water hook-up determines whether the city water is going through the water system or into the fresh water tank. The excess water will be vented from an overflow vent pipe onto the ground when the tank capacity has been reached. This pipe is installed in the fresh water tank to prevent tank rupture from overfilling.



All of the water should be drained from the fresh water system when the unit is not in use for more than one week. Whenever possible, drain the fresh water tank before traveling or only carry what you will need to get to your destination. Water in the tank will reduce the carrying capacity of the unit.

Fresh Water Valve

FRESH WATER CONNECTION

AD-16

The rotating "Fresh Water Valve" located in the water compartment is used to pressurize the fresh water system in your unit, as well as to fill the fresh water tank when the unit is connected to city water. Simply rotate the "Fresh Water Valve" to the appropriate position to perform the desired function. For units equipped with the auto fill feature, auto fill must also be enabled at the monitor panel inside of the coach. You can also monitor the fresh water tank and auto fill function via the SilverLeaf touchscreen (if equipped).



IMPORTANT

If you leave this valve in the manual tank fill position, you may experience low water pressure while operating the water pump.



Mountain Aire, London Aire, Essex, King Aire



Ventana LE, Ventana, Dutch Star



Bay Star and Bay Star Sport

City Water Connection

Before connecting to your coach, use a potable water source to purge any remaining air and stale water in the hose. Then, connect the hose from the potable water source to your coach or the hose from your coach to the city water supply (if equipped with a hose reel). Turn on the supply valve at the water source, and open each of the faucets to remove any air pockets in the coach plumbing lines. Once the water flows freely, close the faucet(s).



IMPORTANT

Use a water hose manufactured and labeled for potable water to ensure that the hose will not alter the taste of the water.

CITY WATER CONNECTION

AD-14

The water pump is used to pressurize the fresh water system when the unit is not connected to city water. The city water supply is under pressure, so the water pump is not necessary while you are connected to city water. Once the city water fill valve is not in the manual fill position, the water is supplied to the fresh water system components, including the hot water heater and faucets.

To disconnect from the city water supply, close the valve from water supply, remove the hose from the city water supply, and store it in the water compartment.

Fresh Water Lines and Plumbing Leaks

FRESH WATER ONLY

NI-094

Vibration and flexing during traveling can cause pipes and fittings to work loose. Follow this checklist to prevent or repair any plumbing leaks:

- Check all of the plumbing connections for leaks on a yearly basis.
- If the water pump runs when all faucets are turned off, check for a leak.
- Be sure the drain valves are closed.
- Tighten any loose faucet connections with a wrench.
- Disconnect the connections completely, and check for mineral deposits or foreign material on the sealing surfaces. Clean the surfaces thoroughly, and reinstall the fitting.

- Take the coach to an authorized service center for repairs if the system continues to leak.

Winterizing the Fresh Water System

This fresh water system has been protected with non-toxic anti-freeze. Please flush and drain lines before using.

AD-70

Follow the winterizing instructions in the Care and Maintenance section to reduce the risk of leaks caused by cracks from freezing pipes. Damage caused from the fresh water system freezing can be extensive and costly to repair. A new coach may be equipped with a similar label if the system has been winterized.



IMPORTANT

Once water has been introduced into the system, it is no longer protected and must be winterized again any time the coach may be subjected to freezing temperatures.

For More Information

Refer to the product manufacturer's owner's manual and links to learn more about your coach's plumbing system and its components.

Hose Reels

Located in the water compartment, the city water connection is made with a white hose approximately 35 feet in length wrapped on the reel. In conjunction with the “Fresh Water Fill Valve”, this water source is used for a number of purposes, including pressurizing the plumbing in your unit, and filling the fresh water tank.



IMPORTANT

These brief operation instructions are for quick reference only. Any quick start instructions provided should not take the place of the complete Operation Manual provided by this item's manufacturer.

The hose reel deploys manually by pulling the hose outward from the compartment. Once the desired length of hose has been reached, hook up the hose to a potable water source. A switch located on the side of the hose reel requires activation for retracting power.

For More Information

Refer to the product manufacturer's owner's manual and links to learn more about your coach's hose reels.

Kitchen Faucets and Fixtures

Your installed kitchen faucet is one of many brands and configurations Newmar offers to their customers, as well as one of many available finishes. Additionally, some coach models may utilize a pull-out sprayer connected to their kitchen faucet.

Maintenance

The faucets and fixtures can be cleaned by wiping with a soft, damp cloth. Avoid using “S.O.S.” type cleaning pads or other abrasive cleaners because they may scratch the surface. Washing with warm water will remove dry water spots. Do not use cleaners that contain harsh or abrasive chemicals. Alcohol or similar solvents should never be used.

For More Information

Refer to the product manufacturer's owner's manual and links to learn more about your coach's kitchen faucets and fixtures.

Power Washers, Sprayers, and Exterior Showers

Power Washer

If your coach is equipped with a power washer, make sure the water supply is supplying pressurized water to the equipment with the desired attachment.



IMPORTANT

Use caution when using high pressure water.

Exterior Shower

An exterior shower located on the driver side may be an optional feature on your coach. The exterior shower allows you to rinse off sand or grass, muddy shoes, or bathe your pet outside of your unit. The faucet operates just as it would in your kitchen or bathroom. When finished using the exterior shower, shut off both the hot and cold valves. Do not simply

shut off the valve on the shower head itself, as it may cause hot and cold water to mix at the exterior shower and could allow drastic changes in water temperature throughout the coach.

For More Information

Refer to the product manufacturer's owner's manual and links to learn more about your coach's power washers and sprayers.

Sinks

Newmar installs a wide range of sinks in our coaches, including stainless steel, solid surface, glass and others, as well as drop-in, undermount, and bowl-type installations to achieve different styles and aesthetic designs.

P-Traps

Each of the sink drains have a water trap to prevent holding tank odors from entering the coach. These traps must have water in them in order to trap the odors. While traveling, the water may splash out of the sink drains. While stored, the water may evaporate, allowing an odor to enter the coach. If this occurs, run water from the faucet into the drain, allowing water to fill the trap. Some coach models with a rear shower may have waterless traps in lieu of conventional P-traps.

Maintenance

Use care when cleaning to prevent scratching the surfaces of your sinks. Wash with a mild detergent and a soft cloth. Avoid using "S.O.S." type cleaning pads or other abrasive cleaners because they may scratch the surface.

For More Information

Refer to the product manufacturer's owner's manual and links to learn more about your coach's sinks.

Toilets



IMPORTANT

These brief operation instructions are for quick reference only. Any quick start instructions provided should not take the place of the complete Operation Manual provided by this item's manufacturer.

Before Using the Stool

Before using the stool, treat the tank with water that is mixed with an odor-controlling chemical, which is readily available at any RV supply store. Mix as directed on the holding tank chemical package. After mixing and flushing the chemical mixture, the waste tank is ready for use.



IMPORTANT

Be careful not to spill the chemical on your hands, clothing, or the carpet, as it may cause a permanent stain.

Using the Stool

When using your stool, it is wise to fill the bowl 3/4 full of water. This will help to wash the solids away from directly below the stool and to ensure complete dumping of the holding tank.



IMPORTANT

Before adding water, consult the toilet manufacturer's owner's manual for the specific procedure relating to your system.

After flushing, a small amount of water should remain in the bowl.

Care and Maintenance

The stool should be cleaned regularly for maximum sanitation and operational efficiency. Clean the toilet bowl with a mild bathroom cleaner.



CAUTION

Use only approved RV odor controlling chemicals in the holding tanks. Do not use chlorine or caustic chemicals, such as laundry bleach or drain-opening chemicals, as they will damage the seals in the toilet and dump valves. Products containing ammonia and petroleum will damage the ABS plastic holding tanks and seals.



WARNING

On coaches equipped with a macerator or macerator toilet(s), do not flush diaper wipes, feminine hygiene products, or any other products that would not be easily liquified. Also avoid using holding tank deodorant capsules, as they may cause damage to the macerator. Damage resulting from flushing any materials or objects other than organic waste and toilet paper are not warrantable repairs.

For More Information

Refer to the product manufacturer's owner's manual and links to learn more about your coach's toilets.

Tubs and Shower Enclosures

P-Traps

NOTICE

Remove the waterless trap before using mechanical drain-cleaning devices. Waterless trap can be damaged.

AD-123

The shower drain has a water trap to prevent holding tank odors from entering the coach. These traps must have water in them in order to trap the odors. While traveling, the water may splash out of the shower drain. While stored, the water may evaporate, allowing an odor to enter the coach. If this occurs, run water from the faucet into the drain, allowing water to fill the trap. Some coach models with a rear shower may have waterless traps in lieu of conventional p-traps.



IMPORTANT

If standing water occurs in your shower, do not attempt to unplug or open the drain with a coat hanger or a sewer snake. Before taking your coach to a service center, try leveling your coach so that the rear is raised slightly higher than the front. This may correct the condition and prevent drain-cleaning or a service repair.

Care and Maintenance

Make sure doors are closed and latched or locked prior to travel. Wipe down the tub and shower walls with a mild detergent and a soft cloth, as well as any glass enclosures after use to avoid soap scum and hard water deposits. Avoid using "S.O.S." type cleaning pads or other abrasive cleaners to prevent scratching the surfaces of your tub and shower enclosure.

When winterizing your coach, clean up any remaining antifreeze in your tub or shower, as it may cause staining.

For More Information

Refer to the product manufacturer's owner's manual and links to learn more about your coach's tubs and showers.

Waste Water System



These brief operation instructions are for quick reference only. Any quick start instructions provided should not take the place of the complete Operation Manual provided by this item's manufacturer.

Waste Water Holding Tanks



The waste drainage system was designed to provide adequate and safe storage and/or disposal of waste materials. The drainage system uses plastic piping and fittings connected to the sinks, toilet, and holding tanks to provide for their drainage to an outside termination. The unit should be reasonably level for best operation of the system.

There are two separate waste systems: the gray tank system and the black tank system. Each tank has its own control valve, and both tanks drain through the sewer drain hose.

Gray Tank



The gray water holding tank is located in the underbelly of the unit. It is primarily used for the drainage from the kitchen and bath sinks, and the shower.



The gray tank valve must be in the open position when operating the optional washing machine.

Black Tank



The black water holding tank is generally for sewage waste from the stool and is located directly beneath the toilet on standard flushing toilets. Before using the stool, you will need to treat the tank with water that is mixed with an odor-controlling chemical, which is readily available at any RV supply store.



IMPORTANT

Be careful not to spill the chemical on your hands, clothing, or the carpet as it may cause a permanent stain.



CAUTION

Use only approved RV odor-controlling chemicals in the holding tanks. Products containing ammonia and petroleum will damage the ABS plastic holding tanks and seals.

Waste Water Disposal

CAUTION

Keep drain valve closed to minimize the presence of sewer gases. Sewer gases can be present when RV is connected to campground sewage hookup. Can lead to illness or personal injury.

AD-120

Both of the holding tanks terminate in a valve arrangement that permits draining each tank separately or together. The valves that open to release the water are called gate valves. The blade that closed the opening in the sewer drain pipes is connected to the T-handle to release the contents of the tank(s) when pulled. The sewer line must be securely capped during self-containment use to prevent leakage of waste material onto the ground or pavement.

Do not pull the holding tank gate valve open, or operate the electric dump valve switch (if equipped) when the protective cap is installed on the pipe. Always drain the tank into an acceptable sewer inlet or dump station.



WARNING

Holding tanks are an enclosed sewer system and must be drained into an approved dump station. Both black and gray water holding tanks must be drained and rinsed thoroughly on a regular basis in order to prevent the accumulation of harmful or toxic materials.

How to Drain the Black Holding Tank

The holding tanks should only be drained when they are at least three-fourths full, to provide sufficient water to allow the complete flushing of waste materials in the drain lines and hose. If the tanks are not three-fourths full, add enough water to allow for sufficient flushing. Whenever possible, drain the holding tanks prior to traveling. The carrying capacity of your unit will be reduced if water is left in the black or gray tanks.

To empty the waste water tanks, follow the procedure below, depending on the type of waste system your coach uses. It is recommended to drain the black water tank before the gray water tank.

Draining the Black Water Tank on a Coach with a Standard Gravity Drain and Dump System

1. Connect the adapter to the drain hose.
2. Unscrew the drain cap, and connect the hose with the adapter to the drain fitting.
3. Open the gate valve all the way by pulling on the T-handle. The tank will start to drain as soon as the T-handle is pulled.
4. After you have drained the black water tank, immediately drain the gray water tank, allowing the water from the gray tank to wash the black water residue from the drain lines and hose.
5. When both of the tanks are empty, flush them with fresh water before you close the valves. Flush the he gray tanks by pouring a couple of gallons of water into a sink drain. The drain outlet is engineered for quick release of the drain hose adapter.
6. Always close the gate valves and secure the end cap to prevent leakage while in transit.

7. Add a holding tank deodorant to help control the odor and break down the solid waste.

Draining the Black Water Tank on a Coach with a Macerator Waste System

1. Make sure the black and gray water dump valves are closed.
2. Point the hose nozzle upward, and remove the nozzle cap.
3. Insert the nozzle into the sewer connection.
4. Open the gray water dump valve, and run the macerator pump for a few seconds to confirm that the system is operating correctly.



IMPORTANT

If there is a problem with the connection, or if the system is not functioning correctly, the macerator may need to be cleaned or serviced.

5. Shut the gray water dump valve, and turn off the pump switch once you have determined that there are no problems.
6. Open the black water dump valve, and turn on the macerator pump switch.
7. Monitor the tank as it empties. The pump will run louder when the tank is empty.
8. Turn off the pump switch once the tank is empty.
9. Flush the black tank, and operate the macerator while it is flushing.
10. Turn off the flush system, then turn off the macerator.
11. Close the black water dump valve.
12. Add tank chemicals and the amount of water recommended by the chemical manufacturer.
13. Drain the gray tank next to help flush out the macerator and sewer hose.

How to Drain the Gray Water Tank

1. Open the gray water dump valve.
2. Turn on the pump switch.
3. Monitor the tank as it empties. The pump will run louder when the tank is empty.
4. Turn off the pump switch once the tank is empty.
5. Close the gray water dump valve.
6. Place the cap on the hose and store it.
7. Add tank chemicals and the amount of water recommended by the chemical manufacturer.

Holding Tank Rinse - No Fuss Flush

SEWER HOSE

This unit may be equipped with a flushing system for the holding tanks. When draining your sewer tank, attach a water hose to the sewer spray hookup. After the tank is drained, leave the gate valve open, and open the water valve to allow water to spray inside the sewage tank. Allow the water to rinse the tank for a minimum of three to five minutes to ensure it is clean. This should flush the inside of the tank of any debris that may be left inside.

CAUTION

Do not use the tank flush valve unless the fullway termination valve is in the open position.

Can result in an unsanitary condition leading to illness or personal injury.

AD-125

CAUTION

SEWAGE TANK RINSE
Open gate valve when
in use.

NI-23

Next, disconnect the freshwater hose and close the gate valve. If there are any solids still left inside the tank, fill the sewage tank with approximately ten gallons of water through the stool. As you travel, the agitation of the water should help liquefy any solids left in the tank. You can dump the sewage tank again at your next destination.



IMPORTANT

Always drain the sewage tank prior to rinsing. Never rinse a sewage tank that is full. The sewage drain must be open while rinsing the sewage tank, and the drain hose must be positioned to drain into an approved sewage dump station. Failure to open the valve will cause the sewage tank to fill with water, and can cause damage to your plumbing and interior.



CAUTION

Do not use the same hose for the No Fuss Flush that is used for filling the fresh water tank. The gate valve to the sewage tank must be in the OPEN position while rinsing with the No Fuss Flush system.

P-Traps

NOTICE

Remove the waterless trap before using mechanical drain-cleaning devices. Waterless trap can be damaged.

AD-123

Each of the sink drains, the shower drain, and the washing machine drain (if equipped) has a water trap to prevent holding tank odors from entering the coach. These traps must have water in them in order to trap the odors. While traveling, the water may splash out of the sink and shower drains. While stored, the water may evaporate, allowing an odor to enter the coach. If this occurs, run water from the faucet into the drain, allowing water to fill the trap. Some coach models with a rear shower may have waterless traps in lieu of conventional p-traps



IMPORTANT

If standing water occurs in your shower, do not attempt to unplug or open the drain with a coat hanger or a sewer snake. Before taking your coach to a service center, try leveling your coach so that the rear is raised slightly higher than the front. This may correct the condition and prevent drain-cleaning or a service repair.

Camping with Sewer Hook-Up

When camping at parks with sewer hook-up, it is important to keep the black water holding tank gate valve closed at all times, except when dumping. The gray tank can be kept open while hooked to a sewer connection, but the black water tank must be kept closed. This is done so that an ample supply of liquid remains in the tank to provide a smooth flow through the gate and drain valve when dumping. Sufficient liquid in the tank causes a swirling action that should take

any accumulated solid wastes with it. Accumulation of solid wastes in the black water tank can be avoided by keeping the gate valve closed when connected to the sewer hook-up. If the valve is left open, solid wastes may accumulate in the tank. This may eventually result in costly repairs.

For More Information

Refer to the product manufacturer's owner's manual and links to learn more about your coach's waste water system.

Water Heaters

Direct Spark Ignition Water Heaters



IMPORTANT

Before operating the water heater, the tank must be filled with water.



WARNING

Do not store any combustible materials or liquids near or adjacent to the water heater.

How to Operate a Water Heater on LP

1. Make sure the water heater is full of water and is not bypassed.
2. Turn on the gas valve on the LP tank.
3. Prior to activating the water heater, smell for any gas odors, as any present fumes may create a spark and flame.
4. Turn on the switch to light the burner. The control board will attempt three times to ignite the LP at the burner. After three attempts, the red indicator light at the switch will illuminate.
5. If lockout occurs, turn the switch off, and wait several seconds before turning it back on. It will make three more attempts to light the burner.
6. On initial startup, it may take a few cycles to purge the LP lines.
7. If the water heater continually fails to light, refer to the Operator's Manual for your specific water heater.

Propane Distribution Lines



WARNING

The primary gas supply manifold is a black steel pipe running the length of the unit. Most secondary lines leading to the gas appliances are made of copper tubing with flare fittings. If any of these lines rupture, do not attempt to splice them. Always run a new line. Gas distribution work must be performed by an authorized service technician. When removing or servicing any gas appliance, close the main gas valve on the propane tank to prevent dangerous gas leakage that could result in an explosion and possible serious injury. If a gas leak is suspected, have the system inspected and repaired by a qualified service technician as soon as possible.

How to Operate a Water Heater with an Electric Element on 120 Volt Power

1. Check for the proper voltage supply (120 Volts).
2. Make sure the water heater is full of water and is not bypassed.
3. Turn on the switch to the electric element. The water heater will control the temperature.
4. If the water heater fails to heat, refer to the Operator's Manual for your specific water heater.

Pressure Relief Valve

The temperature and pressure relief valve is located on the exterior of the water heater. It is designed to open if the temperature of the water within the heater reaches 210° F, or if the water pressure in the heater reaches 150 pounds.

Recreational vehicle water systems are closed systems, and during the water heating cycle the pressure build-up in the water system may reach 150 pounds. When this pressure is reached, the pressure relief valve will open and water will drip from the valve. This dripping will continue until the pressure is reduced below 150 pounds, and the valve closes. This condition is normal and does not indicate a defective relief valve.



Water Heater By-Pass System

The water heater by-pass valve is located near the water heater. By closing the water heater supply valve and opening the by-pass valve, you can divert water away from the water heater. Using the by-pass while winterizing your unit will keep antifreeze out of the water heater. Draining the water heater during winterizing is required.

Water Heater Storage

When storing your coach for the winter months, the water heater must be drained to prevent damage from freezing.

1. Turn off all electrical power and the propane supply to the water heater.
2. Turn off the water pump.
3. Open both the hot and cold water faucets to relieve the pressure in the lines and water heater.
4. Open the drain on the water heater (if equipped), or remove the drain plug or anode rod.
5. Drain the entire water system and follow the winterization instructions provided in Newgle.

When preparing the coach for use after it has been stored, make certain the water system, including the water heater, has been filled before restoring electric and the propane supply.

For More Information

Refer to the product manufacturer's owner's manual and links to learn more about your coach's water heater.

Water Pumps

The water pump is self-priming and totally automatic, operating on demand whenever water is required. The water pump is used to pressurize the fresh water system when the unit is not connected to city water. When the water pump switch is turned on, the water pump will build pressure in the system, and will shut off as soon as the system is correctly pressurized. When a faucet is opened, the pump will turn on and operate as necessary to maintain the preset pressure in the system.



IMPORTANT

These brief operation instructions are for quick reference only. Any quick start instructions provided should not take the place of the complete Operation Manual provided by this item's manufacturer.

Operating Instructions

1. Fill or partially fill the fresh water supply tank.
2. Open the kitchen and bathroom faucets.
3. Turn the water pump switch on and allow the water to fill the water line and the hot water heater. The switch to this pump may be located in the bathroom.
4. Close each faucet after it delivers a steady stream of water (close the cold water first). Leave the hot water faucets on until they also deliver a steady stream of water. This will ensure that the water heater is filled with water.
5. The water pump should stop running once all faucets are closed.
6. The pump is now ready for automatic operation. The pump will run when a faucet is opened and stop when a faucet is closed.



CAUTION

Never allow the pump to run for long periods of time without water in the supply tank, as pump damage or blown fuses may result.

Troubleshooting

If water doesn't flow when a faucet is turned on while using the demand system, use the following troubleshooting chart:

Problem	Solution
The pump is running, but there is no water.	<ul style="list-style-type: none"> • Fill the tank. • Clear the water line to the pump. • Rotate the city water / tank fill valve to the correct position.
The pump isn't running.	<ul style="list-style-type: none"> • Check the pump switch. • Check the 12 Volt fuses. • Check the electrical connections. • Check the battery.

Care and Maintenance

All of the water should be drained from the fresh water system when the unit is not in use for more than one week.

For More Information

Refer to the product manufacturer's owner's manual and links to learn more about your coach's water pump.

Slideouts



Newmar pushed the RV industry forward by introducing the first flat floor slideouts. We continue to lead today with our patented flat floor slideout designs. The same insight and experience that helped us improve slideout functionality has also helped us improve slideout quality. This category provides information about your flat floor, bedroom, kitchen, wardrobe, and full wall slideouts. Under each sub-category, you will have access to information about each slideout in your Newmar coach.

The following warnings may be posted in the coach overhead compartment, in a cabinet, or on the wall next to the corresponding slideouts.



WARNING

Before operating any slideout, read and follow the posted warning labels.

⚠ WARNING

Do not allow children to operate the slide-out. Do not allow any person to place their arms, legs, body or head between any pinch point of the lock arms, slide-out fascia, interior walls, exterior walls, objects, or floor as serious injury or death could result.

Any adjustments, or repairs, must be made only by "NEWMAR" qualified personnel.

Always check the interior and exterior of the coach for objects, or persons, that are in the path of the slide-out when extending or retracting the room.

Always check the roof to be sure any objects, or debris, are removed before retracting the room. Operator must remain continually in control of the slide-out room control switch while the room is moving in or out.

NI-121

⚠ WARNING

Be sure that driver's seat is in the forward position before activating the slide out room.

NI-043

Before Extending the Slideouts

1. Park the coach on a reasonably level campsite.
2. Leave the coach at ride-height with air in the air bags (if equipped with air suspension) or on normal suspension (coaches without air suspension).
3. Plug the coach into shore power (if available).
4. For a full wall slideout, visually inspect the front vertical trim for adequate clearance. The spacing should look even from top to bottom. (See image for reference.)
5. Verify that the path of the slideout is unobstructed and free from any surrounding objects, both inside and outside of the coach.
6. Once the appropriate conditions are met, follow the operating instructions posted in your coach to extend the slideouts.
7. Deploy the leveling jacks.



IMPORTANT

In the unlikely occasion that the slideout trim has inadequate clearances, try leveling or repositioning the coach and rechecking the clearances before retracting the slideout.

Before Retracting the Slideouts

1. Retract the leveling jacks.
2. Start the coach.
3. Allow the coach air suspension to fill and return to ride height (units without air suspension will return to normal suspension).
4. Turn the engine off.
5. Verify that the path of the slideout is unobstructed and free from any surrounding objects, both inside and outside of the coach. This includes any water or debris that may have collected on the topper awning.
6. Retract the slideouts.
7. Inspect all slideouts for complete retraction.
8. Unplug the coach from shore power when you are ready to depart.

Electric Bedroom Slideouts

The operating switch for the bedroom slideout is usually located on the bedroom wall. If there is a full wall slideout on the driver side of the coach, the switch may be located on the wall that separates the bedroom from the living room.

In order to operate the bedroom slideout with the required voltage levels, batteries should be fully charged, the generator should be powered on, or the coach should be connected to shore power. This maintains the voltage levels required to operate the slideouts.

Due to the slideout safety feature commonly referred to as 'ignition lockout', the operation of your slideout will be prohibited under one or more of the following conditions:

- Partial slideout operation is prohibited when the key is in the accessory or run position, allowing the slideout to retract, but not extend.
- Total slideout operation is prohibited when the module receives an ignition signal when the key is in the run position. However, the slideout will operate in the accessory position, because it does not receive an ignition signal.
- Total slideout operation is prohibited when the ignition switch is in either the accessory or run position.
- Total slideout operation is prohibited when the park brake is not set.
- The disabling of the slideout is based on the individual slideout control module programming and the ignition switch circuit signal.

Once the appropriate safety feature conditions are met and the path of the slideout is unobstructed both inside and outside of the coach, follow the operating instructions posted in your coach.

INSTRUCTIONS

MOTORHOMES WITH MECHANICAL LOCK-ARMS

READ ENTIRE SLIDE-OUT ROOM INSTRUCTIONS BEFORE MOVING
SLIDE-OUT ROOM

GENERAL INSTRUCTIONS:

- 1) The coach slide-out rooms will not operate when the ignition key is in the ignition position.
- 2) The slide-out room can be stopped at any time by releasing the switch.
- 3) Amperage setting on units:
WARNING-MOVE SCREW IN SMALL INCREMENTS AND TRY S/O ROOM AGAIN - THERE IS A POTENTIAL FOR COMPONENT OR STRUCTURAL DAMAGE IF THE SCREW IS ADJUSTED TOO HIGH.
NOTE: THIS SCREW DOES NOT ADJUST S/O ROOM SPEED; IT SETS THE AMOUNT OF POWER REQUIRED TO MOVE THE ROOM AGAINST MECHANICAL STOPS.

Extending Slide out Room:

- 1) Slide-out end windows must be shut before moving room.
- 2) Look for and remove any obstructions before moving room.
- 3) **CAUTION ON MOTORHOMES:** Move driver seat forward before moving room (either direction).
- 4) Press and hold the appropriate slide-out switch until the slide-out is fully extended and stops moving.
- 5) Release the switch.

Retracting Slide-out Room:

- 1) Slide-out end windows must be shut before moving room.
- 2) Look for and remove any obstructions before moving room.
- 3) Press and hold the appropriate slide-out switch until the slide-out room is fully retracted and stops moving.
- 4) Release the switch.

MANUAL OPERATION OF ROOM:
Refer to the MANUAL OPERATION INSTRUCTIONS located on the kitchen overhead cabinet.

Revision 01: 2012

INSTRUCTIONS

UNIT EQUIPPED WITH MANUAL LOCK-ARMS

READ ENTIRE SLIDE-OUT ROOM INSTRUCTIONS BEFORE MOVING
SLIDE-OUT ROOM

GENERAL INSTRUCTIONS:

- 1) The slide-out rooms will not operate when the ignition key is in the ignition position.
- 2) The slide-out room can be stopped at any time by releasing the switch.

Extending Slide out Room:

- 1) Slide-out end windows must be shut before moving room.
- 2) Look for and remove any obstructions before moving room.
- 3) **CAUTION ON MOTORHOMES:** Move driver seat forward before moving room (either direction).
- 4) Release lock arms by pulling down from center position (Use lock arm tool as required).
- 5) Press and hold 'OUT' position of the appropriate slide-out switch until the slide-out room is fully extended and stops moving, then release the switch.

Retracting Slide-out Room:

- 1) Slide-out end windows must be shut before moving room.
- 2) Look for and remove any obstructions before moving room.
- 3) Press and hold 'IN' position of the appropriate slide-out switch until the slide-out room is fully retracted and stops moving, then release the switch.
- 4) Before moving coach, engage lock arms by pushing up into locked position (Use lock arm tool as required).

MANUAL OPERATION OF ROOM:
Refer to the MANUAL OPERATION INSTRUCTIONS located on the kitchen overhead cabinet.

Revision 02: 2002

How to Manually Retract an Electric Bedroom Slideout

Provides three possible methods for manually retracting a bedroom slideout if it will not retract on its own.



IMPORTANT

Prior to proceeding with a manual retraction procedure, make sure the ignition key is in the off position and the park brake is set. Then, try retracting the slideout again, as some controllers require the ignition to be off, and others require the park brake to be set.



WARNING

The manual retraction procedures are for emergency use only. These procedures bypass all normal safety features. It is the responsibility of the person(s) performing the procedure to watch for moving parts and pinch points in order to avoid injury.

Procedure 1

This method requires the motor and gear box to be operational. This procedure bypasses the slide controller, switch, and the wiring. If battery power is unavailable or the motor/gear box is inoperable, move to procedure two.



IMPORTANT

This procedure can be performed on any single motor electric slideout.

1. Disconnect the red and black wires connected to the motor.
2. Using the the wires attached to the motor, connect to a 12 volt cordless battery to retract the slideout. If the wire polarity is reversed, the slideout will extend instead of retract.



IMPORTANT

If the slideout motor has a brake installed, you must also hook one brake wire to the battery with the red slideout motor wire and one with the black slideout motor wire.

3. Disconnect the wire(s) from the cordless battery pack.

Procedure 2

Determine which slideout setup your coach utilizes, and follow the steps below pertaining to your specific setup.

Conventional Bedroom Slideout Setup



IMPORTANT

This procedure can be performed on coaches with a slideout motor located under the bed frame.

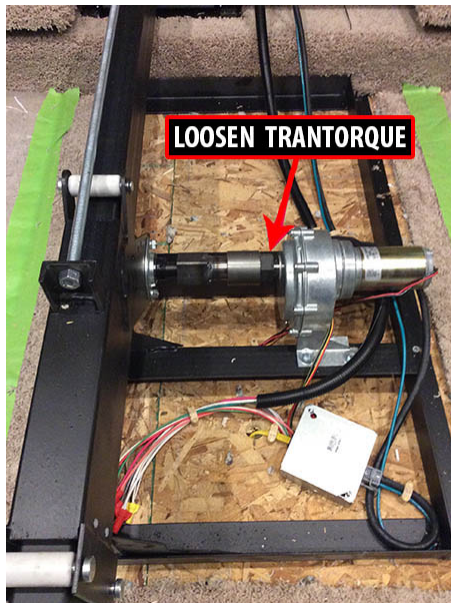

This method is the fastest one if the motor or gears fail, as it does not require battery power. However, this method requires a significant amount of manpower to push in the slideout.

1. Open the lid of the bed box.
2. Loosen the trantorque bushing.
3. Push the room into the retracted position.
4. Retighten the trantorque bushing.
5. Take the coach to an authorized service center for diagnosis and repair.

-or-

1. Open the lid of the bed box.
2. Loosen the trantorque bushing.
3. Turn the shaft with a wrench until the slideout reaches the retracted position. Make sure you do not damage the shaft with the wrench.
4. Retighten the trantorque bushing.
5. Take the coach to an authorized service center for diagnosis and repair.

R-3 Bedroom Slideout Setup with Trantorque at Motor

IMPORTANT

This procedure can be performed on coaches without a square shaft and utilizes a slideout motor located under the slideout floor near the sidewall.

This method is the fastest one if the motor or gears fail, as it does not require battery power. However, this method requires a significant amount of manpower to push in the slideout.

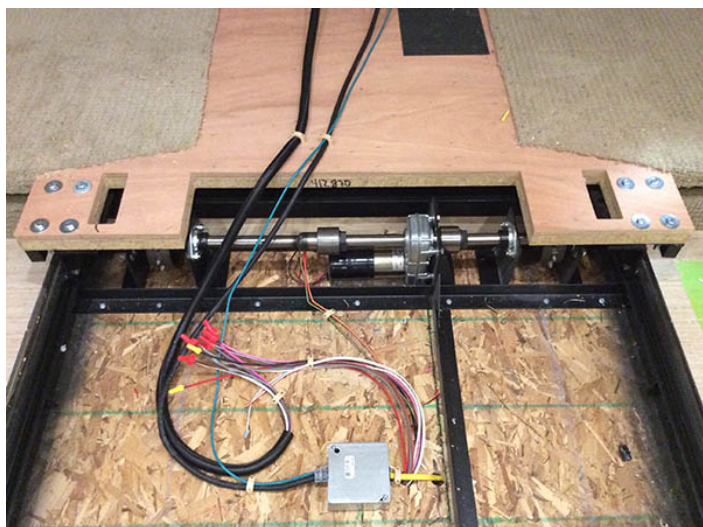

1. Loosen the trantorque bushing at the slideout motor, allowing the slideout to extend and retract freely.
2. Push the room into the retracted position with the assistance of several people. This procedure can be performed on any electric slideout.
3. Remove the motor's black access cover, and tighten the trantorque bushing to 175 ft. lbs. This procedure can be performed on all electric slideouts.

R-3 Bedroom Slideout Setup with Square Shaft

If the Slideout is Stuck in the Extended Position

1. Remove the four mounting bolts, and move over the slideout motor until it disengages from the square shaft.
2. Manually push the room in or out.

with Manual Lock Arms

3. Lock the room with manual lock arms (if equipped).
4. Take the coach to an authorized service center for diagnosis and repair.

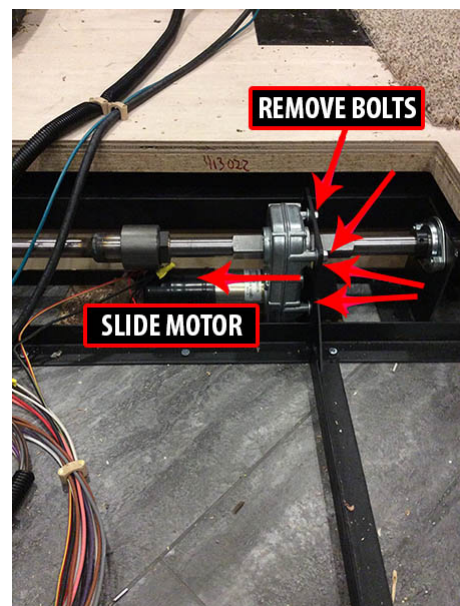

with Mechanical Lock Arms

3. Slide the motor back over onto the square shaft and reinstall the four mounting bolts.
4. Wedge a 2x4" board between the slideout fascia and the exterior wall at the front and back of the slideout roof to hold the slideout in the retracted position.
5. Take the coach to an authorized service center for diagnosis and repair.

If the Slideout is Stuck in the Retracted Position

1. If the motor fails while the slideout is in the retracted position, take the coach to an authorized service center for diagnosis and repair.

Procedure 3

Only a few tools are necessary to complete this procedure; however, it requires the gear box to be operational. Follow the steps to manually retract the slideout by removing the brake and turning the shaft.



IMPORTANT

This procedure can be performed on coaches with a brake on the slideout motor.

1. First, locate the strap that secures the rubber boot on the outside of the motor.
2. Remove the strap, and pull off the rubber boot, removing it from the motor.
3. Remove the four screws from under the rubber boot on the brake.
4. Once the brake is removed, use a wrench to turn the shaft to retract the slideout.

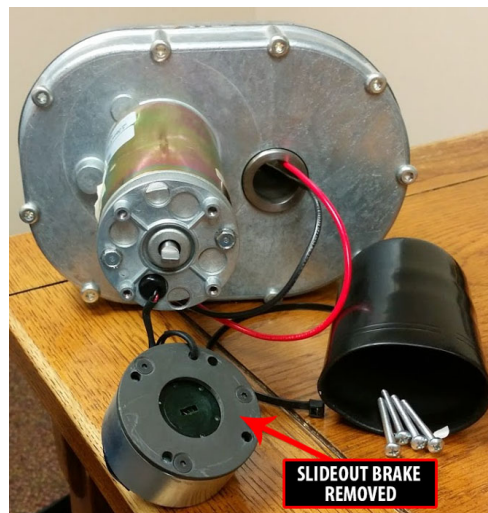
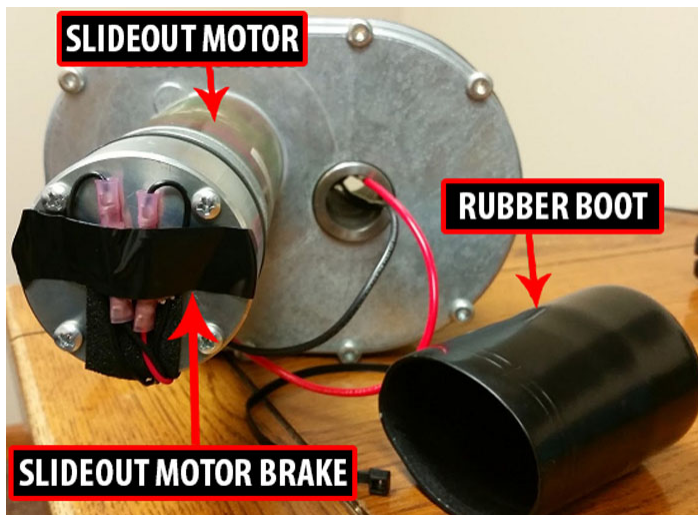

IMPORTANT

Make sure you do not damage portions of the shaft that will slide through the motor, trantorque, bearing, and cog wheels.

4. After the slideout is fully retracted, reinstall the brake.



NOTICE

Depending on the year, model, and floorplan of the coach, the exact slideout motor(s) location may vary. Generally, they may be accessed from under the bed.

Electric Flat Floor Slideouts

The operating switch for the flat floor slideout is usually located in the overhead cabinet above the driver or passenger chair or the overhead cabinet above the entrance door.

In order to operate the flat floor slideout with the required voltage levels, batteries should be fully charged, the generator should be powered on, or the coach should be connected to shore power. This maintains the voltage levels required to operate the slideouts.

Due to the slideout safety feature commonly referred to as 'ignition lockout', the operation of your slideout will be prohibited under one or more of the following conditions:

- Partial slideout operation is prohibited when the key is in the accessory or run position, allowing the slideout to retract, but not extend.
- Total slideout operation is prohibited when the module receives an ignition signal when the key is in the run position. However, the slideout will operate in the accessory position, because it does not receive an ignition signal.
- Total slideout operation is prohibited when the ignition switch is in either the accessory or run position.
- Total slideout operation is prohibited when the park brake is not set.
- The disabling of the slideout is based on the individual slideout control module programming and the ignition switch circuit signal.

Once the appropriate safety feature conditions are met and the path of the slideout is unobstructed both inside and outside of the coach, follow the operating instructions posted in your coach.

INSTRUCTIONS

MOTORHOMES WITH MECHANICAL LOCK-ARMS

READ ENTIRE SLIDE-OUT ROOM INSTRUCTIONS BEFORE MOVING
SLIDE-OUT ROOM

GENERAL INSTRUCTIONS:

- 1) The coach slide-out rooms will not operate when the ignition key is in the ignition position.
- 2) The slide-out room can be stopped at any time by releasing the switch.
- 3) Amperage setting on units:
WARNING-MOVE SCREW IN SMALL INCREMENTS AND TRY S/O ROOM AGAIN – THERE IS A POTENTIAL FOR COMPONENT OR STRUCTURAL DAMAGE IF THE SCREW IS ADJUSTED TOO HIGH.
NOTE: THIS SCREW DOES NOT ADJUST S/O ROOM SPEED; IT SETS THE AMOUNT OF POWER REQUIRED TO MOVE THE ROOM AGAINST MECHANICAL STOPS.

Extending Slide out Room:

- 1) Slide-out end windows must be shut before moving room.
- 2) Look for and remove any obstructions before moving room.
- 3) **CAUTION ON MOTORHOMES:** Move driver seat forward before moving room (either direction).
- 4) Press and hold the appropriate slide-out switch until the slide-out is fully extended and stops moving.
- 5) Release the switch.

Retracting Slide-out Room:

- 1) Slide-out end windows must be shut before moving room.
- 2) Look for and remove any obstructions before moving room.
- 3) Press and hold the appropriate slide-out switch until the slide-out room is fully retracted and stops moving.
- 4) Release the switch.

MANUAL OPERATION OF ROOM:
Refer to the MANUAL OPERATION INSTRUCTIONS located on the kitchen overhead cabinet.

Revision 01: 2012

INSTRUCTIONS

UNIT EQUIPPED WITH MANUAL LOCK-ARMS

READ ENTIRE SLIDE-OUT ROOM INSTRUCTIONS BEFORE MOVING
SLIDE-OUT ROOM

GENERAL INSTRUCTIONS:

- 1) The slide-out rooms will not operate when the ignition key is in the ignition position.
- 2) The slide-out room can be stopped at any time by releasing the switch.

Extending Slide out Room:

- 1) Slide-out end windows must be shut before moving room.
- 2) Look for and remove any obstructions before moving room.
- 3) **CAUTION ON MOTORHOMES:** Move driver seat forward before moving room (either direction).
- 4) Release lock arms by pulling down from center position (Use lock arm tool as required).
- 5) Press and hold 'OUT' position of the appropriate slide-out switch until the slide-out room is fully extended and stops moving, then release the switch.

Retracting Slide-out Room:

- 1) Slide-out end windows must be shut before moving room.
- 2) Look for and remove any obstructions before moving room.
- 3) Press and hold 'IN' position of the appropriate slide-out switch until the slide-out room is fully retracted and stops moving, then release the switch.
- 4) Before moving coach, engage lock arms by pushing up into locked position (Use lock arm tool as required).

MANUAL OPERATION OF ROOM:
Refer to the MANUAL OPERATION INSTRUCTIONS located on the kitchen overhead cabinet.

Revision 02: 2002

How to Manually Retract an Electric Flat Floor Slideout

If the electric flat floor slideout will not retract on its own, there are three possible methods for retracting it manually.



Prior to proceeding with a manual retraction procedure, make sure the ignition key is in the off position and the park brake is set. Then, try retracting the slideout again, as some controllers require the ignition to be off, and others require the park brake to be set.

IMPORTANT



The manual retraction procedures are for emergency use only. These procedures bypass all normal safety features. It is the responsibility of the person(s) performing the procedure to watch for moving parts and pinch points in order to avoid injury.

WARNING

Manual Retraction Method 1

This method is quick, but requires the motor and gear box to be operational. This procedure bypasses the slide controller, switch, and the wiring.



IMPORTANT

This procedure is possible to perform on any single motor electric slideout.

1. Disconnect the red and black wires attached to the motor from the coach wiring.
2. Using the the wires attached to the motor, connect to a 12 volt cordless battery to retract the slideout. If the wire polarity is reversed, the slideout will extend instead of retract.



IMPORTANT

If the slideout motor has a brake installed, you must also hook one brake wire to the battery with the red slideout motor wire and one with the black slideout motor wire.

3. Disconnect the wire(s) from the cordless battery pack.
4. Take the coach to an authorized service center for diagnosis and repair.

Manual Retraction - Method 2

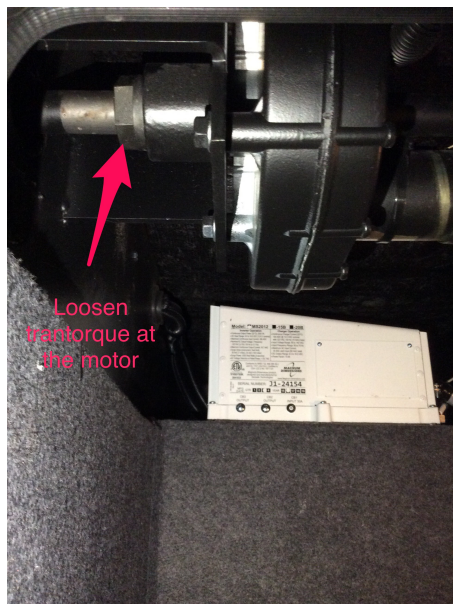

This method requires a significant amount of manpower.

1. Loosen the trantorque bushing at the slideout motor, allowing the slideout to extend and retract freely.
2. Now the room can be pushed in manually with the assistance of several people.
3. After the slideout has been pushed in, tighten the trantorque bushing to 175 ft. lbs.

Manual Retraction - Method 3

The third option takes longer; however, only a screw gun or ratchet is required. Follow the steps to manually retract the slideout using the gear reduction nuts.

1. First, locate the strap that secures the rubber boot on the outside of the motor.
2. Remove the strap, and pull off the rubber boot, removing it from the motor.
3. Remove the four screws from under the rubber boot on the brake.

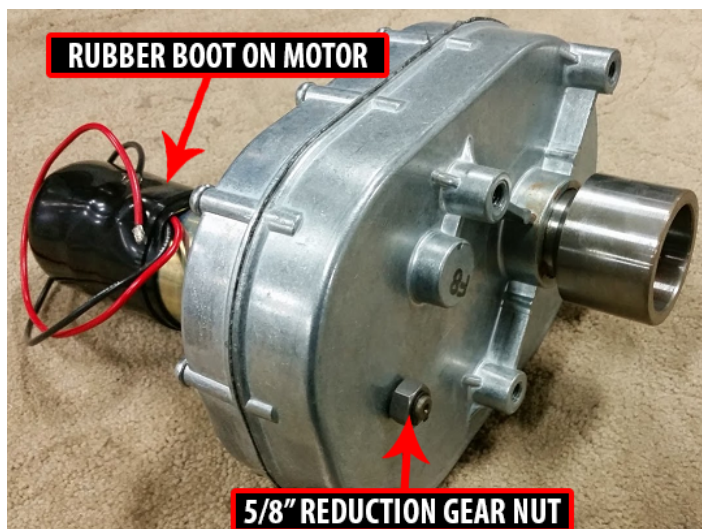

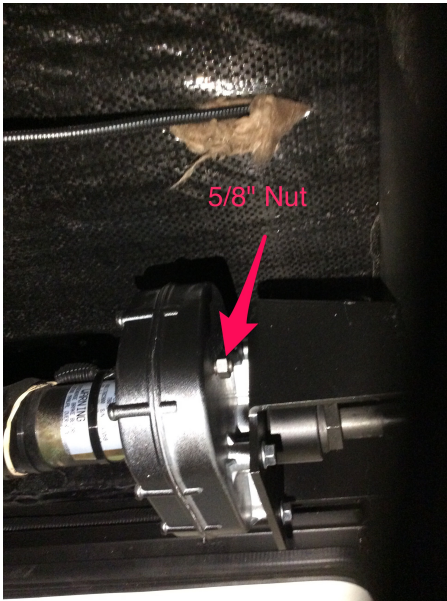

4. Once the brake is removed, use a screw gun or a ratchet with a 5/8" socket to turn the gear reduction nut to retract the slideout.



IMPORTANT

Screw guns are recommended due to the major reduction in the gears. It will take many revolutions of the gear reduction nut to retract the slideout.

4. After the slideout is fully retracted, reinstall the brake.
5. Take the coach to an authorized service center for diagnosis and repair.



NOTICE

Depending on the year, model, and floorplan of the coach, the exact slideout motor(s) location may vary. Generally, they may be accessed from under the slideout in the compartment area.

Electric Full Wall Slideouts

Most electric full wall slideouts extend from the living area to the master bathroom in a Newmar coach.

How to Operate the Full Wall Slideout

In order to operate the full wall slideout with the required voltage levels, batteries should be fully charged, the generator should be powered on, or the coach should be connected to shore power. This maintains the voltage levels required to operate the slideouts.

Due to the slideout safety feature commonly referred to as 'ignition lockout', the operation of your slideout will be prohibited under one or more of the following conditions:

- Partial slideout operation is prohibited when the key is in the accessory or run position, allowing the slideout to retract, but not extend.
- Total slideout operation is prohibited when the module receives an ignition signal when the key is in the run position. However, the slideout will operate in the accessory position, because it does not receive an ignition signal.
- Total slideout operation is prohibited when the ignition switch is in either the accessory or run position.
- Total slideout operation is prohibited when the park brake is not set.
- The disabling of the slideout is based on the individual slideout control module programming and the ignition switch circuit signal.

Once the appropriate safety feature conditions are met and the path of the slideout is unobstructed both inside and outside of the coach, follow the operating instructions posted in your coach.

INSTRUCTIONS
MOTORHOMES WITH MECHANICAL LOCK-ARMS

READ ENTIRE SLIDE-OUT ROOM INSTRUCTIONS BEFORE MOVING
SLIDE-OUT ROOM

GENERAL INSTRUCTIONS:

- 1) The coach slide-out rooms will not operate when the ignition key is in the ignition position.
- 2) The slide-out room can be stopped at any time by releasing the switch.
- 3) Amperage setting on units:
WARNING: MOVE SCREW IN SMALL INCREMENTS AND TRY S/O ROOM AGAIN – THERE IS A POTENTIAL FOR COMPONENT OR STRUCTURAL DAMAGE IF THE SCREW IS ADJUSTED TOO HIGH.
NOTE: THIS SCREW DOES NOT ADJUST S/O ROOM SPEED; IT SETS THE AMOUNT OF POWER REQUIRED TO MOVE THE ROOM AGAINST MECHANICAL STOPS.

Extending Slide out Room:

- 1) Slide-out end windows must be shut before moving room.
- 2) Look for and remove any obstructions before moving room.
- 3) **CAUTION ON MOTORHOMES:** Move driver seat forward before moving room (either direction).
- 4) Press and hold the appropriate slide-out switch until the slide-out is fully extended and stops moving.
- 5) Release the switch.

Retracting Slide-out Room:

- 1) Slide-out end windows must be shut before moving room.
- 2) Look for and remove any obstructions before moving room.
- 3) Press and hold the appropriate slide-out switch until the slide-out room is fully retracted and stops moving.
- 4) Release the switch.

MANUAL OPERATION OF ROOM:
Refer to the MANUAL OPERATION INSTRUCTIONS located on the kitchen overhead cabinet.

Revision 01: 2012

INSTRUCTIONS
UNIT EQUIPPED WITH MANUAL LOCK-ARMS

READ ENTIRE SLIDE-OUT ROOM INSTRUCTIONS BEFORE MOVING
SLIDE-OUT ROOM

GENERAL INSTRUCTIONS:

- 1) The slide-out rooms will not operate when the ignition key is in the ignition position.
- 2) The slide-out room can be stopped at any time by releasing the switch.

Extending Slide out Room:

- 1) Slide-out end windows must be shut before moving room.
- 2) Look for and remove any obstructions before moving room.
- 3) **CAUTION ON MOTORHOMES:** Move driver seat forward before moving room (either direction).
- 4) Release lock arms by pulling down from center position (Use lock arm tool as required).
- 5) Press and hold 'OUT' position of the appropriate slide-out switch until the slide-out room is fully extended and stops moving, then release the switch.

Retracting Slide-out Room:

- 1) Slide-out end windows must be shut before moving room.
- 2) Look for and remove any obstructions before moving room.
- 3) Press and hold 'IN' position of the appropriate slide-out switch until the slide-out room is fully retracted and stops moving, then release the switch.
- 4) Before moving coach, engage lock arms by pushing up into locked position (Use lock arm tool as required).

MANUAL OPERATION OF ROOM:
Refer to the MANUAL OPERATION INSTRUCTIONS located on the kitchen overhead cabinet.

Revision 02: 2002

How to Manually Retract an Electric Full Wall Slideout

Provides step-by-step instructions for manually retracting a full wall slideout when it will not retract on its own.

IMPORTANT

Prior to proceeding with a manual retraction procedure, make sure the ignition key is in the off position and the park brake is set. Then, try retracting the slideout again, as some controllers require the ignition to be off, and others require the park brake to be set.

WARNING

The manual retraction procedures are for emergency use only. These procedures bypass all normal safety features. It is the responsibility of the person(s) performing the procedure to watch for moving parts and pinch points in order to avoid injury.

If the full wall slideout will not retract on its own, there are two possible methods for retracting it manually. The first option is quicker, but requires a significant amount of manpower. The second option takes longer; however, only a screw gun or ratchet is required.

Manual Retraction - Method 1

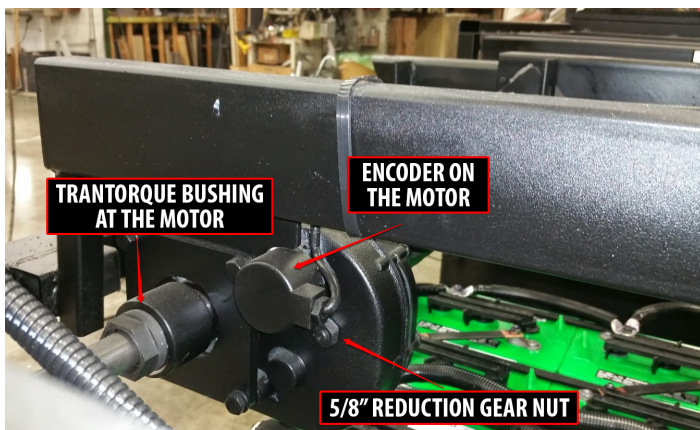

This will be the hardest of the two options for full wall slideout manual retraction, as it requires assistance from several people as noted below. Follow the steps to retract the full wall slideout manually.

1. Loosen the transtorque bushing at each slideout motor, allowing the slideout to extend and retract freely. There are two motors on a full wall slideout, and both transtorque bushings will need to be loosened.
2. Now the room can be pushed in manually with the assistance of several people, as the full wall slideout will need to be pushed up the ramp onto the floor.
3. After the slideout has been pushed in, tighten the transtorque bushings to 175 ft. lbs.

Manual Retraction - Method 2

Follow the steps to manually retract the slideout using the gear reduction nuts.

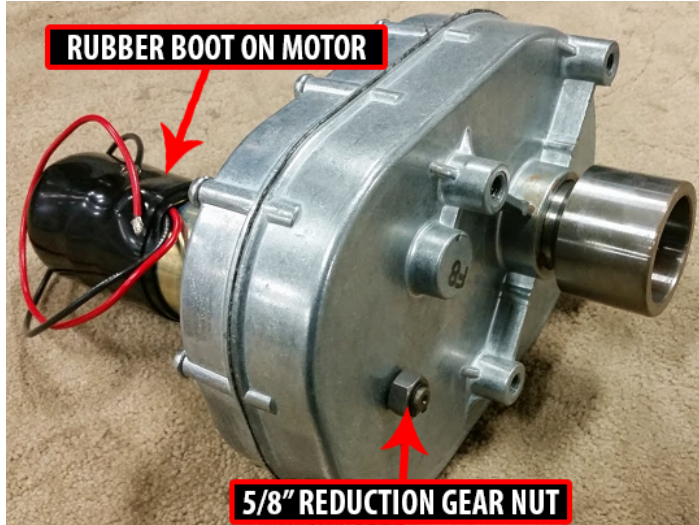

1. First, locate the strap that secures the rubber boot on the outside of the motor.

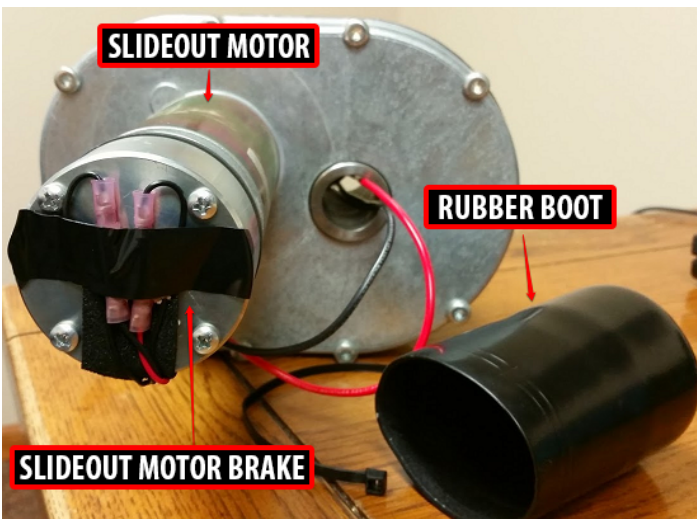

2. Remove the strap, and pull off the rubber boot, removing it from the motor.

3. Remove the four screws from under the rubber boot on the brake.

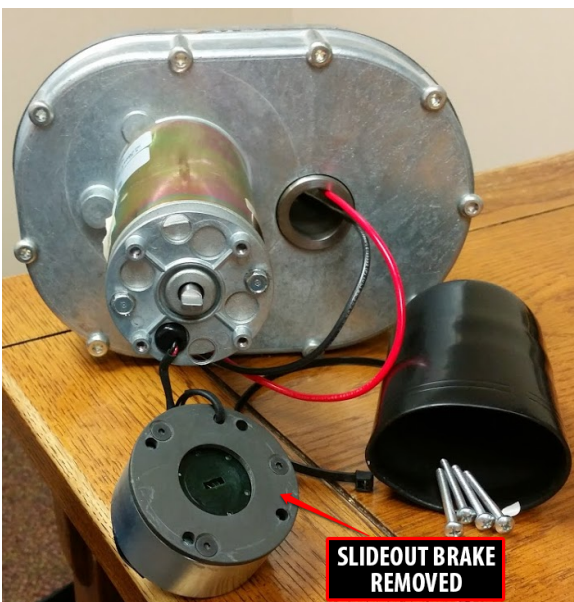

4. Once the brake is removed, repeat the process for the second motor.

5. Use a screw gun or a ratchet with a 5/8" socket to turn the gear reduction nut to retract the slideout.



IMPORTANT

This process will need to be done in an alternating sequence when more than one motor is used. This is necessary to prevent the room from binding, unless you have a second person to perform the retraction procedure on the second motor at an equal retraction speed.



IMPORTANT

Screw guns are recommended due to the major reduction in the gears. It will take many revolutions of the gear reduction nut to retract the slideout.

6. After the slideout is fully retracted, reinstall the brake.
7. Take the coach to an authorized service center for diagnosis and repair.



NOTICE

Depending on the year, model, and floorplan of the coach, the exact slideout motor(s) location may vary. Generally, they may be accessed from under the slideout in the compartment area. Some motors may also be located in the wheel well area under a cover.

Electric Kitchen Slideouts

The operating switch for the kitchen slideout is usually located in the overhead cabinet above the driver or passenger chair or the overhead cabinet above the entrance door.

In order to operate the kitchen slideout with the required voltage levels, batteries should be fully charged, the generator should be powered on, or the coach should be connected to shore power. This maintains the voltage levels required to operate the slideouts.

Due to the slideout safety feature commonly referred to as 'ignition lockout', the operation of your slideout will be prohibited under one or more of the following conditions:

- Partial slideout operation is prohibited when the key is in the accessory or run position, allowing the slideout to retract, but not extend.
- Total slideout operation is prohibited when the module receives an ignition signal when the key is in the run position. However, the slideout will operate in the accessory position, because it does not receive an ignition signal.
- Total slideout operation is prohibited when the ignition switch is in either the accessory or run position.
- Total slideout operation is prohibited when the park brake is not set.
- The disabling of the slideout is based on the individual slideout control module programming and the ignition switch circuit signal.

Once the appropriate safety feature conditions are met and the path of the slideout is unobstructed both inside and outside of the coach, follow the operating instructions posted in your coach.

INSTRUCTIONS

MOTORHOMES WITH MECHANICAL LOCK-ARMS

READ ENTIRE SLIDE-OUT ROOM INSTRUCTIONS BEFORE MOVING
SLIDE-OUT ROOM

GENERAL INSTRUCTIONS:

- 1) The coach slide-out rooms will not operate when the ignition key is in the ignition position.
- 2) The slide-out room can be stopped at any time by releasing the switch.
- 3) Amperage setting on units:
WARNING-MOVE SCREW IN SMALL INCREMENTS AND TRY S/O ROOM AGAIN – THERE IS A POTENTIAL FOR COMPONENT OR STRUCTURAL DAMAGE IF THE SCREW IS ADJUSTED TOO HIGH.
NOTE: THIS SCREW DOES NOT ADJUST S/O ROOM SPEED; IT SETS THE AMOUNT OF POWER REQUIRED TO MOVE THE ROOM AGAINST MECHANICAL STOPS.

Extending Slide out Room:

- 1) Slide-out end windows must be shut before moving room.
- 2) Look for and remove any obstructions before moving room.
- 3) **CAUTION ON MOTORHOMES:** Move driver seat forward before moving room (either direction).
- 4) Press and hold the appropriate slide-out switch until the slide-out is fully extended and stops moving.
- 5) Release the switch.

Retracting Slide-out Room:

- 1) Slide-out end windows must be shut before moving room.
- 2) Look for and remove any obstructions before moving room.
- 3) Press and hold the appropriate slide-out switch until the slide-out room is fully retracted and stops moving.
- 4) Release the switch.

MANUAL OPERATION OF ROOM:

Refer to the **MANUAL OPERATION INSTRUCTIONS** located on the kitchen overhead cabinet.

Revision 01: 2012

INSTRUCTIONS

UNIT EQUIPPED WITH MANUAL LOCK-ARMS

READ ENTIRE SLIDE-OUT ROOM INSTRUCTIONS BEFORE MOVING
SLIDE-OUT ROOM

GENERAL INSTRUCTIONS:

- 1) The slide-out rooms will not operate when the ignition key is in the ignition position.
- 2) The slide-out room can be stopped at any time by releasing the switch.

Extending Slide out Room:

- 1) Slide-out end windows must be shut before moving room.
- 2) Look for and remove any obstructions before moving room.
- 3) **CAUTION ON MOTORHOMES:** Move driver seat forward before moving room (either direction).
- 4) Release lock arms by pulling down from center position (Use lock arm tool as required).
- 5) Press and hold 'OUT' position of the appropriate slide-out switch until the slide-out room is fully extended and stops moving, then release the switch.

Retracting Slide-out Room:

- 1) Slide-out end windows must be shut before moving room.
- 2) Look for and remove any obstructions before moving room.
- 3) Press and hold 'IN' position of the appropriate slide-out switch until the slide-out room is fully retracted and stops moving, then release the switch.
- 4) Before moving coach, engage lock arms by pushing up into locked position (Use lock arm tool as required).

MANUAL OPERATION OF ROOM:

Refer to the **MANUAL OPERATION INSTRUCTIONS** located on the kitchen overhead cabinet.

Revision 02: 2002

How to Manually Retract an Electric Kitchen Slideout



IMPORTANT

Prior to proceeding with a manual retraction procedure, make sure the ignition key is in the off position and the park brake is set. Then, try retracting the slideout again, as some controllers require the ignition to be off, and others require the park brake to be set.



WARNING

The manual retraction procedures are for emergency use only. These procedures bypass all normal safety features. It is the responsibility of the person(s) performing the procedure to watch for moving parts and pinch points in order to avoid injury.

If the kitchen slideout will not retract on its own, there are a few possible methods for retracting it manually.

Manual Retraction - Method 1

Method one is quick, but requires the motor and gear box to be operational. This procedure bypasses the slide controller, switch, and the wiring.



NOTICE

This method can be performed on any single motor electric slideout.

Disconnect red and black wires that are connected to motor. Using the the wires attached to the motor, connect to 12v cordless battery to run slide out in. If wire polarity is reversed slide will run out instead of in. Disconnect the wire(s) from the cordless battery pack.



IMPORTANT

If the slideout motor has a brake installed, you must also hook one brake wire to the battery with the red slideout motor wire and one with the black slideout motor wire.

Manual Retraction - Method 2

Method two is the fastest method without using battery power, and the most practical if the motor or gears fail. This method requires a significant amount of manpower to push in the slideout.

Coaches with a Trantorque Bushing and Round Shaft



1. Loosen the trantorque bushing(s) at the slideout motor(s), allowing the slideout to extend and retract freely.
2. Now the room can be pushed in manually with the assistance of several people.
3. After the slideout has been pushed in, tighten the trantorque bushing to 175 FT Lbs.

Coaches without a Trantorque Bushing and with Square Shaft

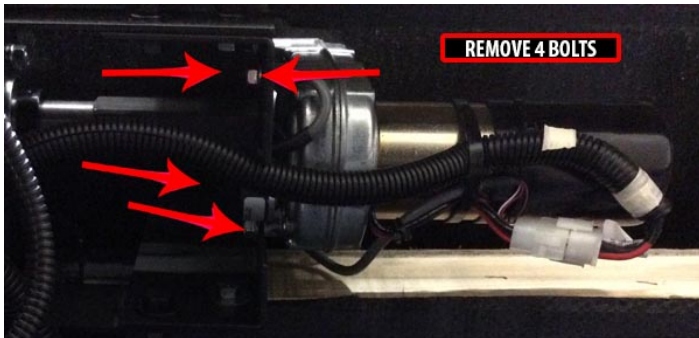

1. Remove the four motor mounting bolts.
2. Slide the motor(s) off of the square shaft. Due to clearance issues on some floorplans, it may be necessary to remove the brake to gain enough clearance to slide the motor off of the shaft.
3. Now the room can be pushed in manually with the assistance of several people.
4. Reinstall the motor, motor mounting bolts and the brake if it was removed.
5. Take the coach to an authorized service center for diagnosis and repair.

Manual Retraction - Method 3

Method three takes longer; however, only a few tools will be needed. This procedure requires the gear box to be operational. Follow the steps to manually retract the Slideout using wrench(s).

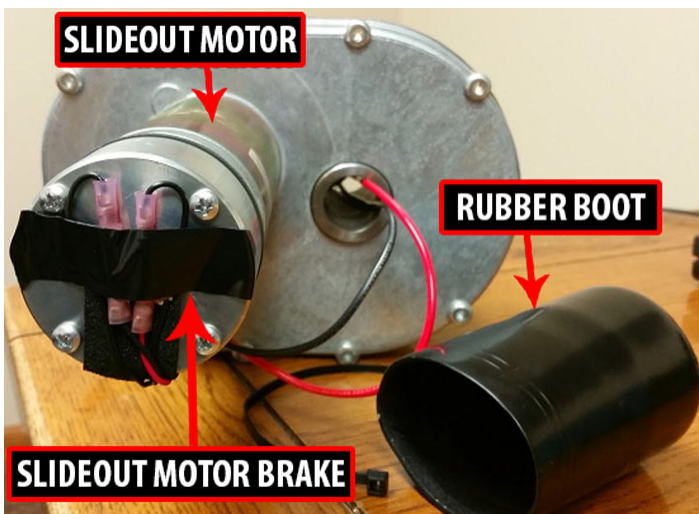

1. First, locate the strap that secures the rubber boot on the outside of the motor.
2. Remove the strap, and pull off the rubber boot to remove it from the motor.
3. Remove the four screws from under the rubber boot on the brake.

3. Once the brake is removed, use a wrench to turn the shaft to retract the slideout.

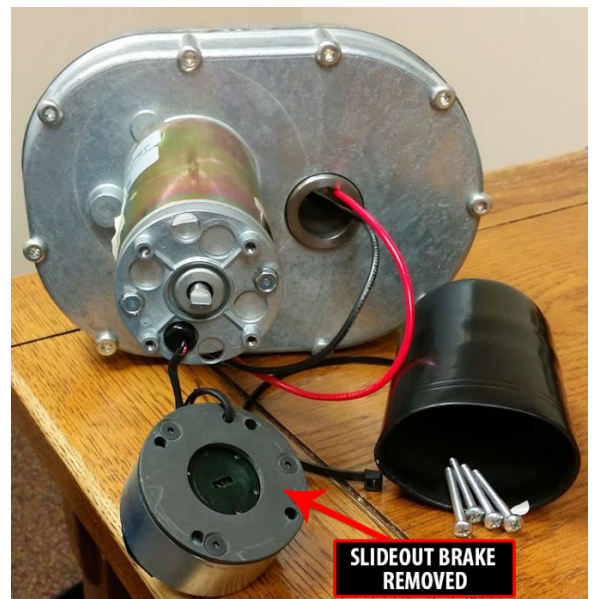



IMPORTANT

When using a wrench to retract the slideout, make sure you do not damage the portion of the shaft that will slide through the motor, trantorque, bearing, and cog wheels.

4. After the slideout is fully retracted, reinstall the brake.
5. Take the coach to an authorized service center for diagnosis and repair.



NOTICE

Depending on the year, model, and floorplan of the coach, the exact slideout motor(s) location may vary. Generally, they may be accessed from under the slideout in the compartment area.

Electric Wardrobe Slideouts

The operating switch for the wardrobe slideout is usually located in the bedroom, on the wall beside the corresponding slideout.

In order to operate the bedroom slideout with the required voltage levels, batteries should be fully charged, the generator should be powered on, or the coach should be connected to shore power. This maintains the voltage levels required to operate the slideouts.

Due to the slideout safety feature commonly referred to as 'ignition lockout', the operation of your slideout will be prohibited under one or more of the following conditions:

- Partial slideout operation is prohibited when the key is in the accessory or run position, allowing the slideout to retract, but not extend.
- Total slideout operation is prohibited when the module receives an ignition signal when the key is in the run position. However, the slideout will operate in the accessory position, because it does not receive an ignition signal.
- Total slideout operation is prohibited when the ignition switch is in either the accessory or run position.
- Total slideout operation is prohibited when the park brake is not set.
- The disabling of the slideout is based on the individual slideout control module programming and the ignition switch circuit signal.

Once the appropriate safety feature conditions are met and the path of the slideout is unobstructed both inside and outside of the coach, follow the operating instructions posted in your coach.

INSTRUCTIONS

MOTORHOMES WITH MECHANICAL LOCK-ARMS

READ ENTIRE SLIDE-OUT ROOM INSTRUCTIONS BEFORE MOVING
SLIDE-OUT ROOM

GENERAL INSTRUCTIONS:

- 1) The coach slide-out rooms will not operate when the ignition key is in the ignition position.
- 2) The slide-out room can be stopped at any time by releasing the switch.
- 3) Amperage setting on units:
WARNING-MOVE SCREW IN SMALL INCREMENTS AND TRY S/O ROOM AGAIN - THERE IS A POTENTIAL FOR COMPONENT OR STRUCTURAL DAMAGE IF THE SCREW IS ADJUSTED TOO HIGH.

NOTE: THIS SCREW DOES NOT ADJUST S/O ROOM SPEED; IT SETS THE AMOUNT OF POWER REQUIRED TO MOVE THE ROOM AGAINST MECHANICAL STOPS.

Extending Slide out Room:

- 1) Slide-out end windows must be shut before moving room.
- 2) Look for and remove any obstructions before moving room.
- 3) **CAUTION ON MOTORHOMES:** Move driver seat forward before moving room (either direction).
- 4) Press and hold the appropriate slide-out switch until the slide-out is fully extended and stops moving.
- 5) Release the switch.

Retracting Slide-out Room:

- 1) Slide-out end windows must be shut before moving room.
- 2) Look for and remove any obstructions before moving room.
- 3) Press and hold the appropriate slide-out switch until the slide-out room is fully retracted and stops moving.
- 4) Release the switch.

MANUAL OPERATION OF ROOM:

Refer to the MANUAL OPERATION INSTRUCTIONS located on the kitchen overhead cabinet.

Revision 01: 2012

INSTRUCTIONS

UNIT EQUIPPED WITH MANUAL LOCK-ARMS

READ ENTIRE SLIDE-OUT ROOM INSTRUCTIONS BEFORE MOVING
SLIDE-OUT ROOM

GENERAL INSTRUCTIONS:

- 1) The slide-out rooms will not operate when the ignition key is in the ignition position.
- 2) The slide-out room can be stopped at any time by releasing the switch.

Extending Slide out Room:

- 1) Slide-out end windows must be shut before moving room.
- 2) Look for and remove any obstructions before moving room.
- 3) **CAUTION ON MOTORHOMES:** Move driver seat forward before moving room (either direction).
- 4) Release lock arms by pulling down from center position (Use lock arm tool as required).
- 5) Press and hold 'OUT' position of the appropriate slide-out switch until the slide-out room is fully extended and stops moving, then release the switch.

Retracting Slide-out Room:

- 1) Slide-out end windows must be shut before moving room.
- 2) Look for and remove any obstructions before moving room.
- 3) Press and hold 'IN' position of the appropriate slide-out switch until the slide-out room is fully retracted and stops moving, then release the switch.
- 4) Before moving coach, engage lock arms by pushing up into locked position (Use lock arm tool as required).

MANUAL OPERATION OF ROOM:

Refer to the MANUAL OPERATION INSTRUCTIONS located on the kitchen overhead cabinet.

Revision 02: 2002

How to Manually Retract a Wardrobe Slideout



IMPORTANT

Prior to proceeding with a manual retraction procedure, make sure the ignition key is in the off position and the park brake is set. Then, try retracting the slideout again, as some controllers require the ignition to be off, and others require the park brake to be set.



WARNING

The manual retraction procedures are for emergency use only. These procedures bypass all normal safety features. It is the responsibility of the person(s) performing the procedure to watch for moving parts and pinch points in order to avoid injury.

Manual Retraction Method 1

This method is quick, but requires the motor and gear box to be operational. This procedure bypasses the slide controller, switch, and the wiring. If battery power is unavailable or the motor/gear box is inoperable, move to the second method.



IMPORTANT

This procedure is possible to perform on any single motor electric slideout.

1. Disconnect the red and black wires attached to the motor from the coach wiring.
2. Using the the wires attached to the motor, connect to a 12 volt cordless battery to retract the slideout. If the wire polarity is reversed, the slideout will extend instead of retract.



IMPORTANT

If the slideout motor has a brake installed, you must also hook one brake wire to the battery with the red slideout motor wire and one with the black slideout motor wire.

3. Disconnect the wire(s) from the cordless battery pack.
4. Take the coach to an authorized service center for diagnosis and repair.

Manual Retraction Method 2

Determine which slideout setup your coach utilizes, and follow the steps below pertaining to your specific setup.

This method is the fastest one if the motor or gears fail, as it does not require battery power. However, this method requires a significant amount of manpower to push in the slideout.

1. Locate the slideout motor.
2. Remove the covers from the motor if it is located in the wheel well area.
3. Loosen the trantorque bushing.
4. Push the room into the retracted position.
5. Retighten the trantorque bushing (175 ft. lbs. for 1" shafts or 145 ft. lbs. for 3/4" shafts).
6. Reinstall any removed covers.

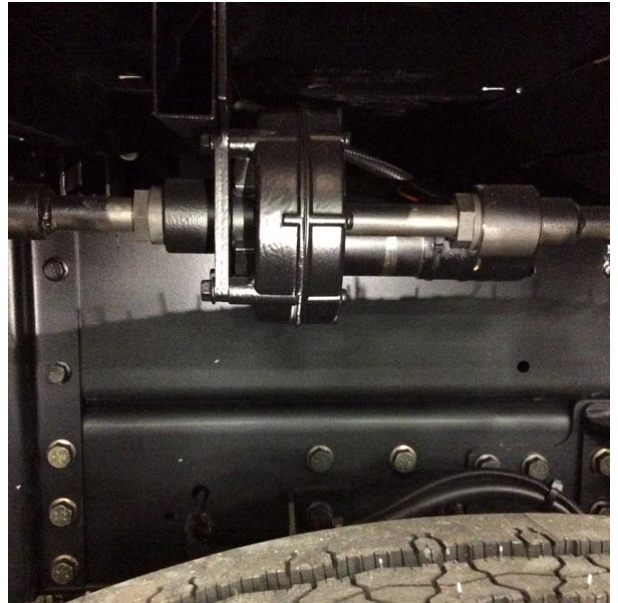
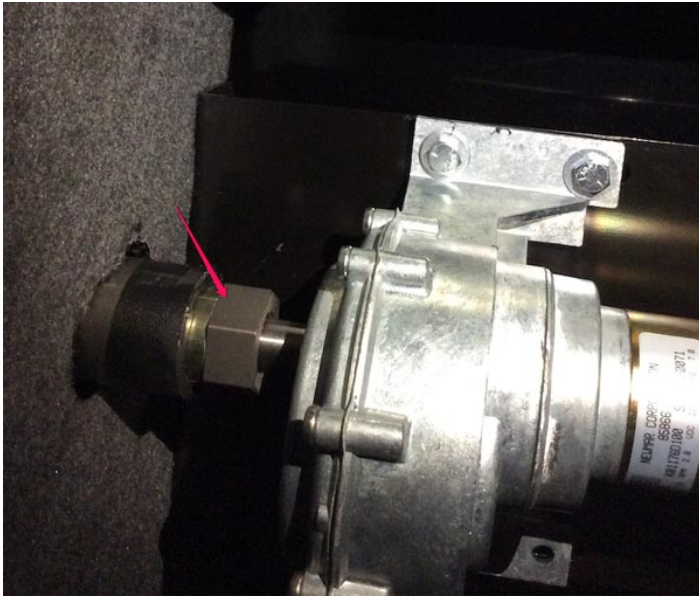

-or-

1. Locate the slideout motor.
2. Remove the covers from the motor if it is located in the wheel well area.
3. Loosen the trantorque bushing.
4. Turn the shaft with a wrench until the slideout reaches the retracted position. Make sure you do not damage the shaft with the wrench.
5. Retighten the trantorque bushing (175 ft. lbs. for 1" shafts or 145 ft. lbs. for 3/4" shafts).
6. Reinstall any removed covers.
7. Take the coach to an authorized service center for diagnosis and repair.

Wardrobe Slideout Motor with Square Shaft



If the Slideout is Stuck in the Extended Position

1. Remove the four mounting bolts, and move over the slideout motor until it disengages from the square shaft.
2. Manually push the room in or out, or use a wrench to rotate the shaft. Make sure you do not damage the shaft with the wrench.

with Manual Lock Arms

3. Lock the room with manual lock arms (if equipped).
4. Take the coach to an authorized service center for diagnosis and repair.

with Mechanical Lock Arms

3. Slide the motor back over onto the square shaft, and reinstall the four mounting bolts.
4. Wedge a 2x4" board between the slideout fascia and the exterior wall at the front and back of the slideout roof to hold the slideout in the retracted position.
5. Take the coach to an authorized service center for diagnosis and repair.



NOTICE

Depending on the year, model, and floorplan of the coach, the exact slideout motor(s) location may vary. Generally, they may be accessed from under the slideout in the compartment area. Some motors may also be located in the wheel well area under a cover.

HWH Hydraulic Flat Floor Slideouts

¹Due to clearance constraints on select floor plans, Newmar has opted to use HWH slideout systems on select coaches. "Power your slide-out with a SpaceMaker® room extension system from HWH®. [HWH has] a full selection of above-floor, below-floor, level-in/level-out and full-wall models. [HWH's] room extension systems feature the same rugged construction, through engineering and top grade materials that have made HWH® the undisputed leader in RV leveling systems."



IMPORTANT

These brief operation instructions are for quick reference only. Any quick start instructions provided should not take the place of the complete Operation Manual provided by this item's manufacturer.



WARNING

Read the HWH Operation manual for your slideout and follow all safety warnings and notices.



CAUTION

When operating the HWH Hydraulic Flat Floor Slideout, the coach must be plugged into shore power or operating on generator power with full voltage, or damage could occur to the coach.

How to Operate the Hydraulic Flat Floor Slideout

The operating switch for the Hydraulic Flat Floor Slideout is usually located in the overhead cabinet above the driver or passenger chair or above the entrance door.

Due to the slideout safety feature commonly referred to as 'ignition lockout', the operation of your slideout will be prohibited under one or more of the following conditions:

- Total slideout operation is prohibited when the ignition switch is in either the accessory or run position.
- Total slideout operation is prohibited when the park brake is not set.

The disabling of the slideout is based on the individual slideout control module programming and the ignition switch circuit signal.

Once the appropriate safety feature conditions are met and the path of the slideout is unobstructed both inside and outside of the coach, follow the operating instructions posted in your coach.

INSTRUCTIONS

UNIT EQUIPPED WITH HWH SLIDE OUTS

READ ENTIRE SLIDE-OUT ROOM INSTRUCTIONS BEFORE MOVING
SLIDE-OUT ROOM

GENERAL INSTRUCTIONS:

- 1) Ignition key must be turned off before operating the slide-out. The slide-out rooms will not operate when the key is in the ignition on or accessories position.
- 2) The slide-out room can be stopped at any time by releasing the switch.

Extending Slide-out Room:

- 1) Slide-out end windows must be shut before moving room.
- 2) Look for and remove any obstructions before moving room.
- 3) **CAUTION ON MOTORHOMES:** Move driver seat forward before moving room (either direction).
- 4) Press and hold 'OUT' position of the appropriate slide-out switch until the slide-out room is fully extended and stops moving. There will be a delay from when the room stops moving till the pump shuts off. Then release the switch.

Retracting Slide-out Room:

- 1) Slide-out end windows must be shut before moving room.
- 2) Look for and remove any obstructions before moving room.
- 3) Press and hold 'IN' position of the appropriate slide-out switch until the slide-out room is fully retracted and stops moving. There will be a delay from when the room stops moving till the pump shuts off. Then release the switch.

MANUAL OPERATION OF ROOM:

Refer to the MANUAL OPERATION INSTRUCTIONS located in owners manual.

Revision: 2015

! WARNING

Be sure that driver's seat is in the forward position before activating the slide out room.

NI-043



IMPORTANT

During normal operation of the room, do not reverse direction of the room until the room is fully extended. If necessary, the direction of the room may be reversed, but watch for binding of the room. If the direction of the room has been reversed, do not re-extend the room until the room has been fully retracted, as the room may not drop to the level out position.



IMPORTANT

Do not hold the 'in' or 'out' switch for more than ten seconds after the room has stopped moving from the fully retracted or fully extended position. If at any time the slideout stops or is in a bind, release the slideout switch immediately. Do not force the room or reverse directions. Contact Newmar Customer Service for assistance.

How to Manually Lift a Hydraulic Flat Floor Slideout



CAUTION

Contact Newmar Customer Service (1-800-731-8300) prior to manually lifting or retracting your Hydraulic Flat Floor Slideout.



IMPORTANT

These brief operation instructions are for quick reference only. Any quick start instructions provided should not take the place of the complete Operation Manual provided by this item's manufacturer.



NOTICE

Manual room lift procedures must be done before manual room retraction procedures.

Step One

¹Determine which synchronizing cylinder controls the room. Manually open the valve release cams for the extend and retract solenoid valves by moving the cams to the "valve opened" position as shown.



IMPORTANT

Release cam might be rotated to any direction on the valve. Make sure to move the release cams in the correct direction. Incorrect movement of the cams can damage the valves.

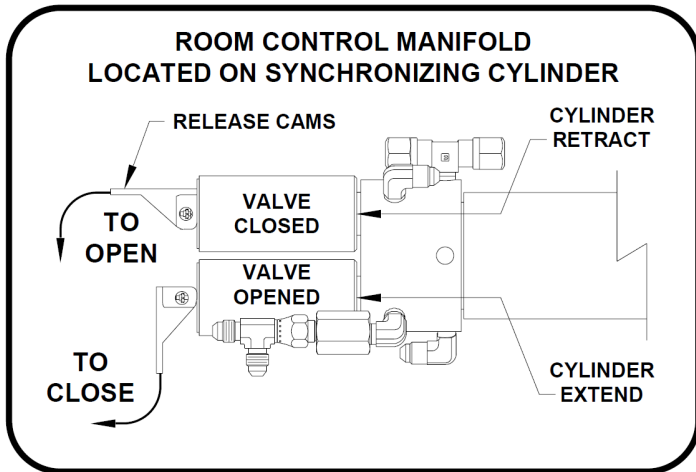

If the pump manifold is equipped with an auxiliary hand pump, you may be able to retract the room by opening only the room retract valve (as labeled by the wiring harness) and operating the hand pump, refer to the "Auxiliary Hand Pump Operation" page (in your HWH Operator's Manual) for instructions on the use of the hand pump and valves equipped with a release cam. If the room cannot be retracted with the hand pump, it will be necessary to use the lift bolts and room retract screws.

Step Two

[Locate the lift cylinder covers. A few examples are shown below (first three images). Do not remove the screws on the flat side of the cover. Instead, remove the screws on the side of the cover, allowing the entire cover to be removed (as shown in the last two images). Depending on the location, some covers may be sealed with foam or another sealant.]

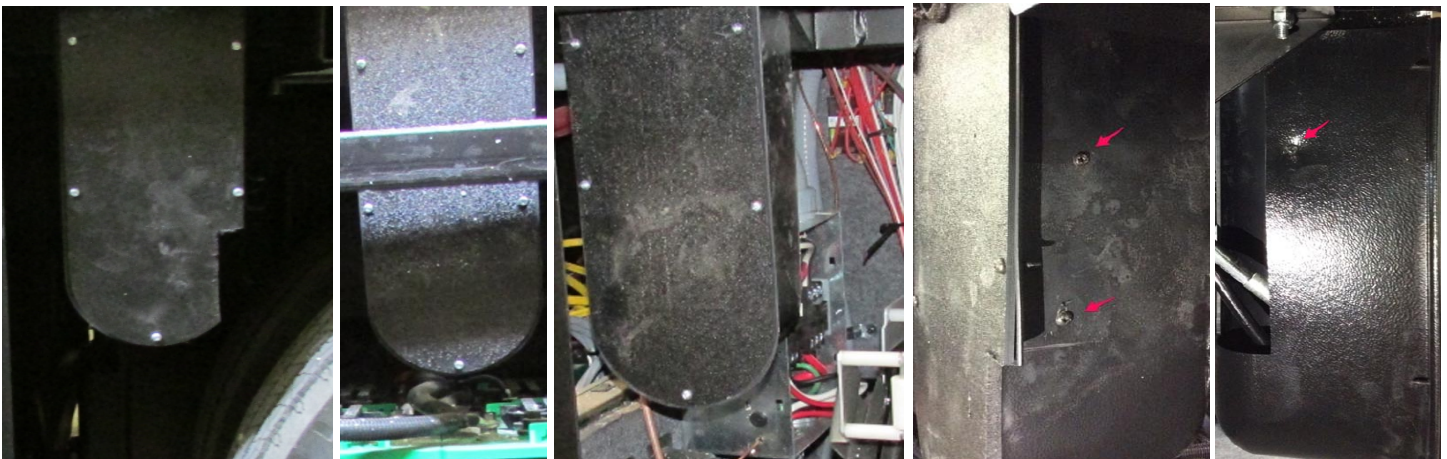

NOTICE

There may be more than one platform lift cylinder assembly. There is a manual lift bolt for each assembly. All lift bolts must be used to lift the room.

Step Three

Use a 13/16 wrench or socket to rotate the lift bolt(s) clockwise until they are seated in the receiver block.



IMPORTANT

Do not use an impact wrench to turn lift bolts.

Continue to turn the bolt(s) until the room is completely lifted. When there are multiple lift bolts, alternate evenly between all lift bolts, turning each bolt two or three complete turns each time. Turning one lift bolt without alternating may cause the room to bind.

Step Four

Leave the valves opened and refer to the "Manual Retract" article for room retract procedures.



IMPORTANT

If at any stage something is not understood, or if the room begins to bind, do not force the room. Contact Newmar Customer Support for assistance.



IMPORTANT

Do not retract lift bolt until you have read the 'Extending Room After Service' section of the 'Manual Retract' article.

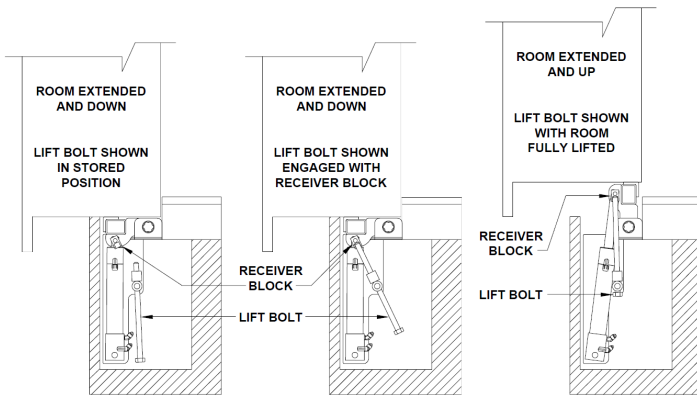

For More Information

Refer to the Universal Platform Level-Out Room Extension Mechanism Manual Room Lift Procedures.pdf

¹ Material sourced from <http://www.hwh.com/ml55155.pdf>

How to Manually Retract a Hydraulic Flat Floor Slideout



CAUTION

Contact Newmar Customer Service (1-800-731-8300) prior to manually lifting or retracting your Hydraulic Flat Floor Slideout.



IMPORTANT

These brief operation instructions are for quick reference only. Any quick start instructions provided should not take the place of the complete Operation Manual provided by this item's manufacturer.



NOTICE

Manual room lift procedures must be done before manual room retraction procedures.

Step One

¹Start both threaded rods until resistance is met, one for the front and one for the rear mechanism should be provided.



NOTICE

To access the threaded plates, refer to the vehicle manufacturer[’s instructions below].



NOTICE

Some Newmar coaches may require removal of the interior vertical fascia, but current coaches are built with removable magnetic pieces or a sliding insert for easy access to the hole and plates. Coaches with lower cabinets secured to the fascia may have a removable access plug. In some cases, this access point may not align with the HWH threaded plate. In these instances, removal of the lower cabinet may be necessary to gain access to the plate.



Dutch Star Access Point



Mountain Aire Access Point



King Aire Access Point

Step Two

Using the wrench provided, a personal wrench or a tire iron with a 1-1/8" opening, rotate either mechanism's threaded rod clockwise six complete turns.



IMPORTANT

Do not use an impact wrench to turn lift bolts.

Step Three

Move to the other room extension mechanism, and rotate the threaded rod clockwise 12 complete turns.

Step Four

Return to the first room extension mechanism, and rotate the threaded rod clockwise 12 complete turns. Repeat steps three and four, alternating from mechanism to mechanism, rotating each threaded rod 12 complete turns until room is sealed. Do not exceed 15 ft. lbs. Make sure the room does not bind.



IMPORTANT

If at any stage something is not understood, or if the room begins to bind, do not force the room. Contact Newmar Customer Support for assistance.



NOTICE

Leave the solenoid valves open, the lift bolts and threaded rods in place until the room has been serviced.

Extending Room After Service

Step One

Room lift bolts should not be retracted yet. Push and hold the room switch to "retract" for five to ten seconds.

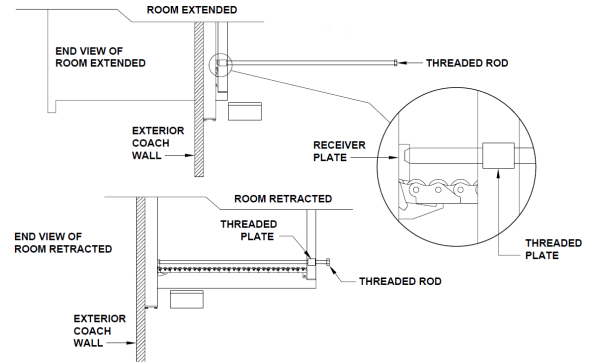

IMPORTANT

Do not extend the room until the room has been serviced. Any solenoid valves left open should be closed. The threaded rods should be completely removed before room is fully extended. If there is not enough room to remove both threaded rods completely, alternate backing the threaded rods out and slightly extending the room. Be careful to not extend the room so far that the threaded rods impact the coach wall or the mechanism.

Step Two

Push the room switch to "extend" until the room is within one inch of being fully extended. Threaded rods should be completely removed at this time. Do not allow room to bind.

Step Three

Retract all lift bolts completely. If room starts to drop, alternate between lift bolts evenly while turning lift bolts.

Step Four

After lift bolts are retracted, push room switch to "extend" until room is fully extended and down. If room dropped while retracting lift bolts, push room switch to "extend" for five to ten seconds.

Step Five

Retract room with room switch.



IMPORTANT

If at any stage something is not understood, or if the room begins to bind, do not force the room. Contact Newmar Customer Support for assistance.

For More Information

Universal Platform Level-Out Room Extension Mechanism Manual Room Lift Procedures.pdf

¹ Material sourced from <http://www.hwh.com/ml55155.pdf> as adapted for Newmar Corporation v.09NOV15



WHEN YOU KNOW THE *Difference*

