

NOTE:  
HORIZONTAL FASCIA IS 1/4" WIDER THAN VERTICAL FASCIA

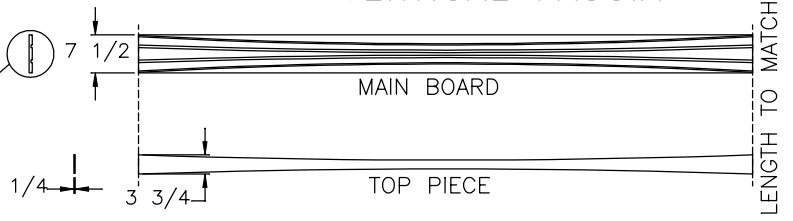
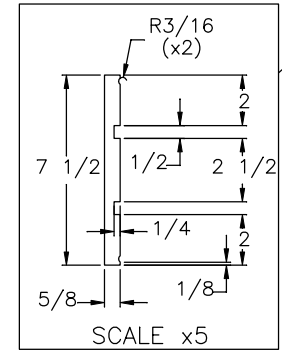

HORIZONTAL FASCIA  
\*NO LIGHTS IN HORIZONTAL FASCIA\*

VERTICAL FASCIA

NOTE:  
2 LIGHT STRIPS PER VERTICAL LEG

NOTE:  
12" IS MAXIMUM THAT CAN BE CUT OFF (6" PER END)

END CAP/ HORIZONTAL DIVIDER PIECE (USED W/ HORIZONTAL AND VERTICAL PIECES)

138928-CALYPSO MAPLE  
136739-SIENNA MAPLE  
138929-ASTORIA MAPLE

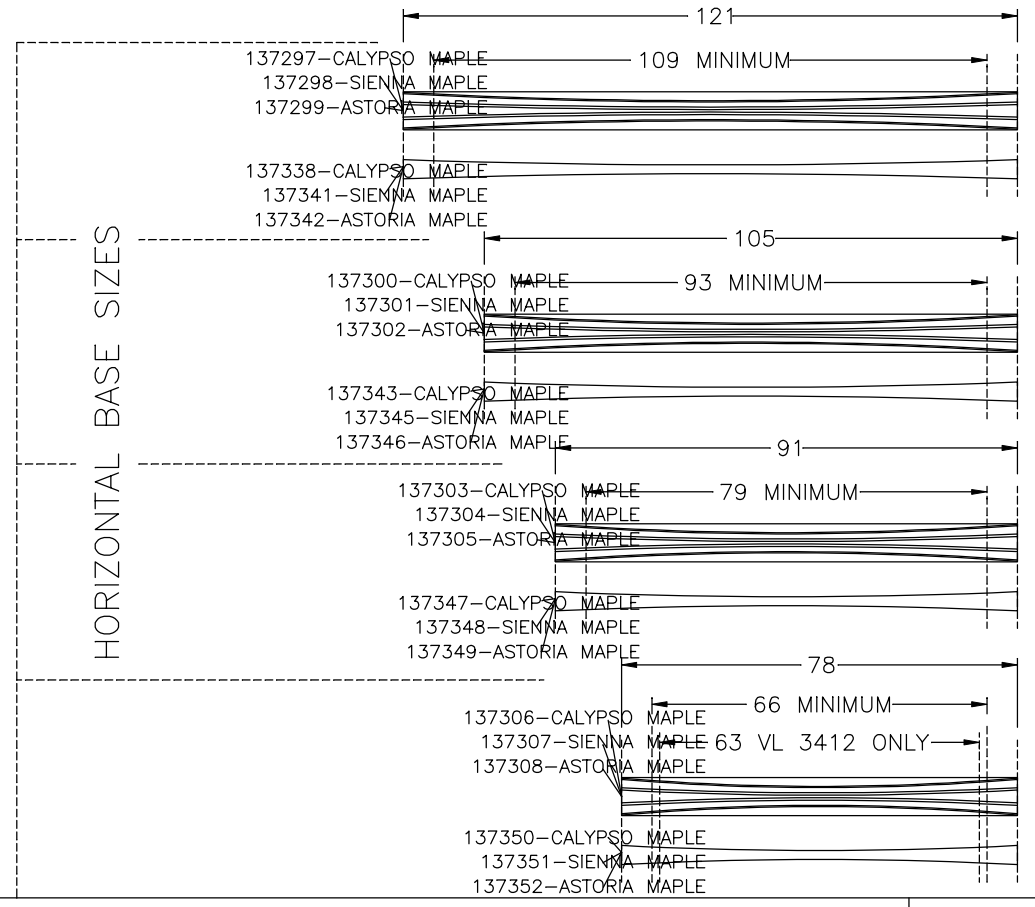
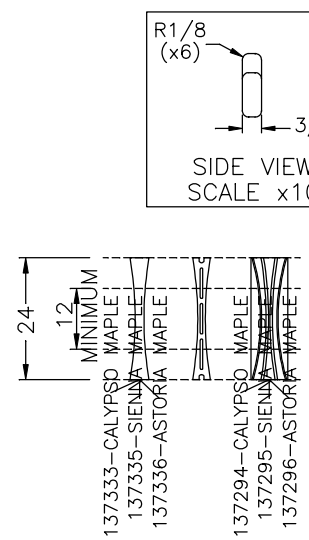
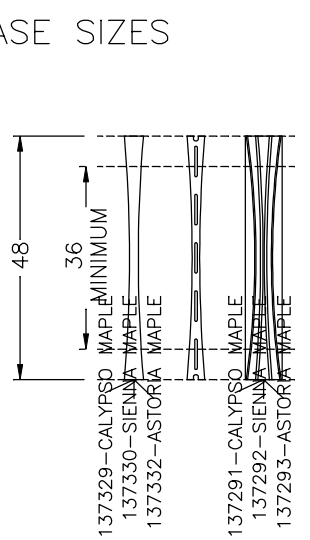
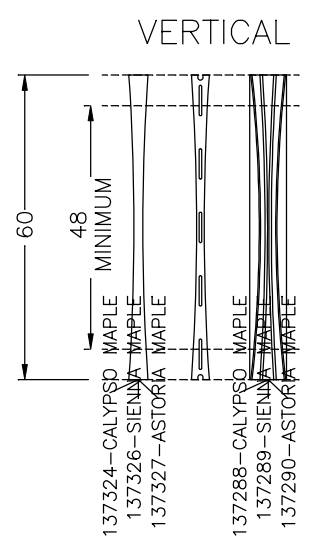
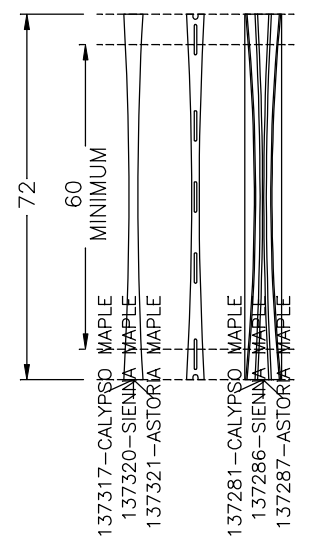
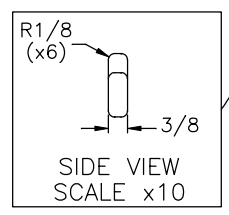

**NEWMAR CORP**  
P.O. Box 30,  
Nappanee, IN. 46550

UNITS: INCHES  
TITLE BLOCK: 75TB

Model: CSCA's/VLDP's

Title: TYPICAL S-O FASCIA

Sheet: 1 OF 1

I.D. # 2018\CA\SO\PARTS\CSCA\_VLDPFASCIA

Drawn by: R. W.

Date: 11/3/16

Checked by: J. S.

Date: 11/4/16

Revision: Added note stating to use 2 light strips per vertical leg for clarification (PCR #181145)

Revision: Added mounting slots to top of diffuser parts. (PCR #180683)

By: R. W.

Date: RR 9/11/17

By: D. E.

Date: 6/21/17