

NEWMAR | 2022

Bay Star

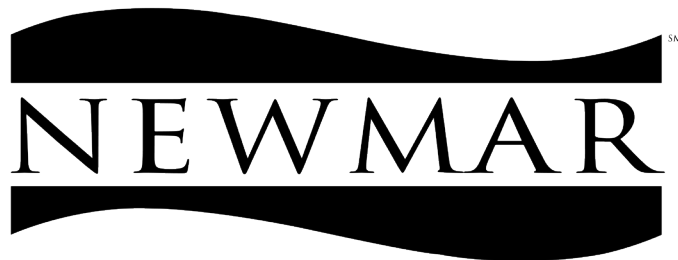



WHEN YOU KNOW THE DIFFERENCE™

Bay Star Owner’s Guide

Table of Contents

Introduction.....	1
Safety	9
Appliances	25
Chassis	43
Electrical.....	49
Electronics.....	79
Entertainment Systems.....	95
Exterior	109
HVAC.....	127
Interior	135
Plumbing.....	147
Slideouts.....	171
Care and Maintenance	179

 NOTICE

This Owner’s Guide is published and printed from Newmar’s online knowledgebase. For the most up-to-date version of this content, and for more product-specific information, how-to articles, and troubleshooting information, please refer to Newgle. All of the information in Newgle is believed to be accurate at the time of publication. However, it may be necessary to make revisions, and Newmar reserves the right to make any such changes without notice or obligation.

This page is intentionally blank.



INTRODUCTION: ABOUT NEWMAR AND YOUR NEW COACH

This chapter provides you with an introduction to Newmar, our warranty process, as well as our seamless service promise. As part of the Newmar family, you now have access to 24/7 support via your designated brand specialist and Newgle, our online knowledgebase.

Newmar's Limited Warranty and Customer Support

Welcome to the exciting world of recreational vehicles and the growing Newmar family! Congratulations on your purchase of a Newmar product! Your coach proudly carries the Newmar torch, as a new generation of RV'ing begins. We share your excitement, and look forward to the years and miles of adventure the RV lifestyle offers you in your coach.

Whether camping at your favorite remote fishing hole or tailgating at the big game with your friends, Newmar is with you 24 hours a day, 7 days a week.



WHEN YOU KNOW THE DIFFERENCE

The Newmar Legacy

Your new coach was built with care using today's technology and old world craftsmanship. At Newmar, we strive to build vehicles that are safe, dependable, and comfortable. Born on Christian principles, and from the desire to build not the most, but the best, the legacy associated with the name Newmar is one of family pride and quality. It is the culmination of decades of RV design and building experience.

We take humble pride in our history of innovation. We introduced the industry to the first slideout rooms, and continued our tradition of innovation with the first flush floor slideout in a motorized coach and the smooth, seamless fiberglass body. Your coach is at the forefront of current technology, built by the skilled hands and quality conscious eyes of craftsmen.

At Newmar, we recognize that a craftsman's final product is only as good as the materials they use, so we are selective about what we put into our coaches. We start with a foundation forged in the strength of steel and aluminum. We fill it with beautiful, durable hardwoods, and select name brand appliances and components, then build it on a chassis built to stand the test of time. Then we finish our units with an artist's gentle touch.

The Newmar Warranty

We stand behind our work with an exceptional warranty and dependable service, so you can travel with the kind of confidence that comes from knowing you're protected. What helps Newmar stand out against other manufacturers is our commitment to following our customers throughout the repair process to ensure any issues get taken care of the right way, right away.

LIMITED ONE-YEAR UNLIMITED MILE WARRANTY

Every Newmar motor coach is backed by our one-year, unlimited-mile expressed limited warranty.

LIMITED FIVE-YEAR STRUCTURAL WARRANTY

If any part of your Newmar recreational vehicle superstructure (which is the steel / aluminum structure of the sidewall, roof or frame) fails to perform properly within five (5) years from the date of purchase because of faulty workmanship or material supplied by Newmar, it will be repaired without charge for either parts or labor by Newmar. This structural warranty is available only to the original purchaser and is non-transferable.

CHASSIS AND COMPONENT MANUFACTURER WARRANTIES

Please read the Newmar Limited Warranty and all other component warranties that apply to the equipment installed on your unit. The limited warranties issued by the chassis and component manufacturers require periodic service and maintenance. The owner's failure to provide this service and/or maintenance may result in the loss of warranty coverage.

Be sure to file the appropriate registration card with the component manufacturer as described with the individual instruction booklets to activate the warranties on the components within your Newmar coach.

If you, for any reason, have a problem obtaining satisfactory and timely warranty service that may substantially impair the use, value, or safety of your Newmar coach, please call Newmar Customer Service toll free at **1-800-731-8300 (option #2)**.

Customer Support

Carefully read both the instructions in your Owner’s Guide, as well as the booklets supplied by the chassis and component manufacturers for important operation, safety, and maintenance information. This Owner’s Guide should be kept in your vehicle for quick reference. Take time to get acquainted with your unit and how it operates. Should you have any questions, consult your dealer or the Newmar customer support team. In addition to the assistance you receive from the customer support team, we are also excited to announce a new approach to customer service: Newgle.

Newgle is Newmar’s dynamic, multi-faceted knowledge center and is created specifically for Newmar coach owners and certified technicians. Because content pertaining to your coach is constantly evolving and changing, the only way we can provide you with access to the most up-to-date and relevant information is by linking you directly to it!

Much of our information comes directly from the manufacturer of the items that are specific to your coach model and year, so we urge you to check out the site for any additional information that may not (currently) be included in your owner’s guide. For more information, refer to the Introduction to Newgle article.

About The Delivery Process

This article provides a detailed list of the customer and dealer responsibilities during the delivery process.

Throughout the manufacturing process, your vehicle has been inspected by Newmar qualified technicians. However, our final inspection at the factory is not to be the last one. The pre-delivery inspection and systems check your dealer performs are the final inspections done to the unit prior to you receiving your new coach. Your dealer may assist you in understanding the limited warranties and with completing all warranty forms for the various appliances and accessories installed in your unit.

Customer Responsibilities

To assist you in avoiding problems with your vehicle, we recommend you do the following:

1. Read the warranty. Go over it thoroughly with your dealer.
2. Inspect the vehicle. Do not accept delivery until you have gone through the coach with the dealer. Newmar has provided a checklist to be used during retail delivery. Check each item on the list, and make sure the dealer does the same. Do not sign this checklist until you have done checked off each item.
3. Ask questions about anything that you do not understand concerning your recreational vehicle.
4. Responsible Use. Your vehicle is designed to be used for recreational or temporary living purposes. It is not designed to be used as a full-time residence or for commercial use. Commercial use means using as a business asset, such as a mobile office or using the vehicle for lease/rental purposes.

⚠ NOTICE

The sales literature versus actual specifics to the vehicle’s measurements, weights, or quantities may vary.

Dealer Responsibilities

1. A pre-delivery inspection and systems check: thoroughly inspecting the vehicle and the operation of the factory installed components.
2. A customer walk-through to familiarize the customer with the vehicle, its systems and components, and

their operation.

3. Delivery of the Owner’s Information Package. This package contains the warranty cards and registrations for the vehicle and factory-installed components that carry a separate warranty. The detailed operating and maintenance instructions on these components are also included in this package.
4. Assisting the customer in completing the component registration forms, at the customer’s request. To avoid loss of warranty coverage, the dealer should review the limited warranty provisions with the customer, stressing the importance of filing warranty cards and registrations to the component manufacturers within the prescribed time limit.
5. Providing the customer with information regarding warranty and non-warranty work on the vehicle, as well as its separately warranted components, whether the customer is in or out of the area.



Owner's Information Package and Appliance Data Sheet

This article provides information about the appliance data sheet posted in the coach, complete with details about coach-installed equipment, as well as the owner's information package.

⚠ NOTICE

The Newmar Owner's Guide, Information Package, and Appliance Data Sheet must not be removed from the vehicle in the event that the coach is sold. These items should remain with the coach for the next owner.

Owner's Information Package (Black Bag) and Newmar Owner's Guide

Included in your Owner's Information package are valuable documents about your vehicle and its components and systems. The Newmar Owner's Guide does not cover every possible detail of the equipment (standard and/or optional) installed on or in your coach. Consulting the booklets and instruction manuals in this package will help you safely operate, maintain, and troubleshoot these items. For more details about each of the components and systems installed in the coach, refer to Newgle.



⚠ IMPORTANT

Read all of the information and understand the safety and operating instructions included in the Owner's Information Package. To assure full warranty coverage, it is essential that all maintenance instructions are followed.

Appliance Data Sheet

An information sheet is provided containing important information about your coach for your convenience.

- Your coach's Newmar Serial Number. This number is needed whenever making an appointment for service or ordering parts through your Newmar Dealer or Service Center.
- Your coach's Vehicle Identification Number (VIN). The VIN is the legal identification of the completed vehicle and is used by the state for vehicle registration.
- Your coach's Year, Model, Type, and Floorplan.
- Manufacturer, Model, and Serial Number of factory-installed equipment. **Use these model numbers to quickly locate relevant information in Newgle about the parts, including links, files, and articles.**

THANK YOU FOR PURCHASING A QUALITY NEWMAR PRODUCT! FOR YOUR CONVENIENCE, WE HAVE ENCLOSED A SERIAL NUMBER LIST OF IMPORTANT EQUIPMENT INSTALLED IN YOUR 2022 DDDP 4362 THE SERIAL NUMBER FOR YOUR UNIT IS - 602227 VIN 4V6A19VLC084331 CHC08 107 WOOD POLAR CAMEL SLATED CHEST-RIND-80

DESCRIPTION	MODEL	SERIAL NUMBER
DASH A/C	RY202058	448073
INVERTER 1	M2812	M61-07191
FRONT RADIO	X330111F	018-03314
MONTION	AC0713	0019207803743
JACK PUMP	AP58462	1838
JACK LEFT FRONT	AP37791	23884
JACK RIGHT FRONT	AP37791	13955
JACK LEFT REAR	AP33137	3117
JACK RIGHT REAR	AP33137	3323
REFRIGERATOR	WFFR082TMS	V08238497
RANGE	873	
WASHER	ANXX119W	80727188
DRYER	17M614	80912014
MICROWAVE	YWOOD7819WE1	7884113894
FREER	CF80	014-018770183
TOLLET 1	8740	84897574
FRONT TV	3000900	81362
REAR TV	4300900	82441
TV #3	4300900	82443
GENERATOR	108DCA-12607B	K180493714
FRONT A/C	651818T510	8524097
CENTER A/C	651818T510	83921655
REAR A/C	651818T510	83921664
REAR CAMERA	VCH0159	K118TCTW0094
SAFF	PWS-1822E	L03F08210228
SATELLITE #1	RTT-208	103118040049284
EXT TV	4300900	04343
SIDE ANNING 1	00	00
ANNING ARM 1	00	00
ANNING DOOR	00	00
WINDOW 1	00	00
WINDOW 2	00	00
WINDOW 3	00	00
WINDOW 4	00	00
WINDOW 5	00	00
SO TOPPER 1	00	00
SO TOPPER 2	00	00
SO TOPPER 3	00	00
SO TOPPER 4	00	00
SOPA 2	147234	
CAPT CHAIR DRIVER	88205 003	
CAPT CHAIR PASSENGER	88205 002	
SATELLITE #2	88205 002	1121180400493394
FIBERGLASS SIDEWALLS (da)		012018854
FIBERGLASS SIDEWALLS (oda)		012018853
ANNING ARM 2	00	00
FIBERGLASS FRONT S/O (da)		012016058
FIBERGLASS REAR S/O (da)		012018856
FIBERGLASS FRONT S/O (oda)		012016059
SIDE CAMERA	VCH012E	L018TCTW0094
SIDE ANNING 2	VCH012L	K0718TCTW0494
TOLLET 2	8740	84897575
WIFI RANGER	11 PROLTRPACATT	924808586CAP-817
WIFI KEYBOX	TYR01020HPND	83787
VIDEO BRAY	34907	CR80-34900-1128-8248
FRONT DVD	BDP-01700	2108484
REAR DVD	BDP-01700	2241158
FRONT CAP	BETTERWAY	
REAR CAP	BETTERWAY	
MISER MOTOR	JUNE 2018	0424
WATER HOSE REEL	WHSR MASTER M	23018
OILS DR-128	DM-12	77280-1128-9273
STL DEFRY/FRY DOOR	014611	098170
HOLDING TANK	AMER-KABT	
FRESH TANK	AMER-KABT	

⚠ IMPORTANT

The manufacturer, model, and serial number of the appliances and accessories installed at the factory in your coach are listed on this label for convenience. It is important that the label remains in the coach for identification purposes. Do not remove or relocate this label.

Notices in Newgle and Newmar’s Owner’s Guide

Reference is made to the following terms throughout Newgle and the Owner’s Guide: Danger, Warning, Caution, Important, and Notice. These terms indicate important information that must be understood and followed.

Safety Definitions

⚠ DANGER

DANGER indicates an imminently hazardous situation that, if not avoided, will result in death or serious injury. Failure to observe a **DANGER** may also result in damage to the equipment or unit.

⚠ CAUTION

CAUTION indicates a potentially hazardous situation that, if not avoided, may result in minor or moderate injury. Failure to observe a **CAUTION** may also result in damage to the equipment or unit.

⚠ WARNING

WARNING indicates a potentially hazardous situation that, if not avoided, could result in death or serious injury. Failure to observe a **WARNING** may also result in damage to the equipment or unit.

⚠ IMPORTANT

IMPORTANT notices are not related to personal injury, but provide additional information to make a step easier or clearer.

NOTE FROM NEWMAR

NOTE FROM NEWMAR indicates helpful information to improve customer experience or satisfaction outside of what is provided by a component manufacturer or supplier.

⚠ NOTICE

NOTICE indicates information that is not necessary or required, but may prove to be helpful.

Newgle Introduction and Navigational Overview

This article provides a brief overview of Newgle: what it is, how to access it, how to navigate it, and what information is available. It also explains the different types of search filters that can be utilized in Newgle to produce the most effective search results.

What Is Newgle, and Why Do I Need It?

Do you have trouble finding reliable and trustworthy resources about your coach? How much time do you spend trying to figure out how to operate your appliances or what cleaning products are safe to use on your floors? What about troubleshooting information when something in your coach just is not working quite right? Do you prefer to find the answer yourself rather than asking for advice online or your neighbor parked next to you at the RV resort, or even contacting your dealer or customer service? You have come to the right place!

Welcome to the wonderful world of Newgle! Our free online knowledgebase provides you with coach information directly from Newmar, as well as our manufacturers and suppliers. Content is added and updated regularly and is only available to current coach owners and authorized service technicians. As part of Newmar’s seamless service promise, your questions can be answered quicker than ever before with just a few clicks on Newgle’s search-focused platform right from your laptop, tablet, or smartphone.

Newgle consists of nearly a dozen categories, hundreds of knowledge articles, and thousands of parts with associated coach models and years, files, and links. Finding coach information is no longer a headache or a chore – It is on Newgle!

Leave the research to us. Our goal is to provide you with the most updated information at all times. Though not coach-specific, Newgle supplies endless documentation about your coach model and year, all verified by Newmar’s Technical Publication department.

⚠ IMPORTANT

Newgle is an ever-changing knowledgebase. The Newgle Team strives to introduce new features and content regularly to improve the site. The included screenshots and navigational instructions may change without notice. Always refer to Newgle for the most up-to-date version of this content.

⚠ NOTICE

Any technical information published in Newgle is only intended for use by qualified, Newmar-authorized service technicians. Newmar is not responsible for misuse of this information.

How Do I Navigate The Website?

The Home Page is a launching pad into the endless sea of knowledge. You can easily return to the home page at any time by clicking the Newgle logo, the “Home” button at the top of the page, or by selecting the “Home” option from your username or nickname in the upper right-hand portion of the screen. There are three key ways to navigate our website: the Category Drop-Downs, Coach Filter, and Search Bar.

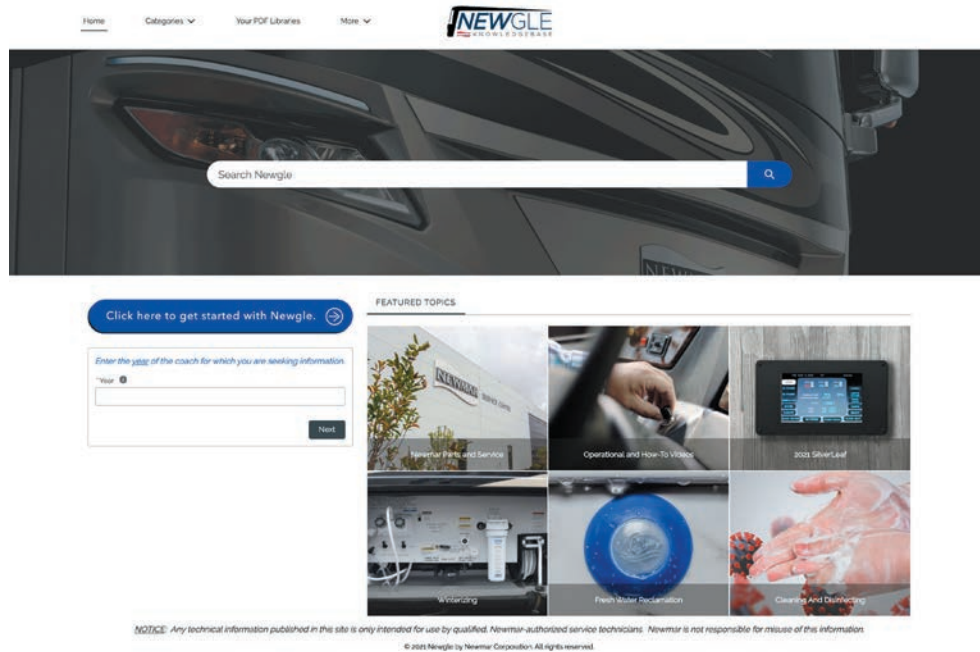

CATEGORY DROP-DOWNS

Navigate through Newgle using the drop downs at the top of the page: Category, Sub-Category, and Product Manufacturer Name. From here, select the model number of the component installed in your coach. This type of navigation provides a basic overview of the site structure, but does not associate products with any coach models or years.

COACH FILTER

To view products and parts related to your coach model and year, click through each option on the home page to narrow your results. First, enter your coach model year, then your model. Then, select the category and sub-category of the information you are seeking. This will narrow your results down to the products and parts that are relevant to these specifications. Then select the component installed in your coach to view the product page, which often includes associated features, files, links, and knowledge articles.

SEARCH BAR

Search from the home page or from anywhere in the site using a key word or phrase, or by the product name, manufacturer, or model number. There is no need to search using coach information like the production number, VIN, model or year. Using the search bar produces the most results of the three different navigational options, which often contain one or more types of the following documentation:

- **Products (Parts) by year and model** - Specific components, items, and parts installed by Newmar, which can be refined by the coach model and year.
- **Files** - Attached documentation provided directly from Newmar’s product manufacturers, suppliers, vendors, and distributors. The file results often include owner’s guides, instruction manuals, installation guides, troubleshooting articles, care and maintenance guides, and much, much more. Files can be filtered on the left side of the screen by title and type of document.
- **Links** – Helpful web addresses of product manufacturers that often contain additional resources such as online warranty registrations, safety information, reference material, contact information, etc.
- **Knowledge articles** - Customer-friendly documentation written or revised by Newmar’s Technical Publications department. These may contain basic operating instructions, additional safety information, product overviews, how-to and troubleshooting articles, as well as related videos produced by Newmar. In the past few years, Newmar’s owner’s guides for each model have been built from such articles, as they are meant to be an operational overview for a new coach owner. Note: The model-year coach filter on the Home screen bypasses these articles unless they are associated with a specific product or part. To view a more complete list of these articles, use the search bar.

After typing a search term or phrase, relevant results will populate on the screen; however, this is often not a comprehensive list. Instead, it only provides a “preview” of the results. For a more exhaustive list, click on the “View More” button in the top right corner of the section you wish to expand. Click on the Show More button at the bottom of the page if you wish to view even more results.

With so many results, it may be necessary to narrow them down. Refine your search results by choosing one of the categories on the left side of the screen: Products by Year Model, Files, Links, or Knowledge Articles, depending on what type of documentation you prefer to view. For example, review parts associated to your coach model and year by clicking on the “Products by Year Model” tab. Then refine your results using the filters shown on the left side of the screen, such as year, model, product description, etc.

Once you find the part that you are looking for, click on the blue link to review the product page for that part. On this page, you will find helpful resources such as a picture (if it is available in Newmar’s online part’s catalog), the product description and features, as well as relevant files, links, and knowledge articles, for all of the documentation provided by Newmar and the part’s manufacturer or supplier.

EXAMPLES

How do I set the clock on my GE Advantium microwave and why does the time disappear from the display when I am not using it?

First, type in a simple search term such as “microwave.” Then, click on the “Products by Year Model” tab on the left side of the screen. Enter your coach year, followed by the model name or abbreviation (Dutch Star Diesel Pusher = DSDP). Click on the magnifying glass or press “Enter” or “Return” for each box. Easily clear one box at a time without erasing all of your search criteria. Note: If you do not know your model abbreviation, refer to the Newgle article titled “How do I find my coach model abbreviation for filtering?”

Select the microwave installed in your coach, and click on the related blue link (i.e. 125682P) to open the “GE Profile Advantium 1.7 Cu Ft 925w Stainless Steel Over-the-Range Microwave Oven” product page. On the product page, review the associated manufacturer’s links and files and select the best option that may answer your question. The user guide or manual often contains operation instructions, care and maintenance recommendations, and troubleshooting tips. The information about the clock is available in the “Other Features” portion of the GE Owner’s Manual.

A knowledge article also answers this question. Use a phrase such as “microwave clock” to locate an article about the GE microwave (PSA9120) containing this information. Scroll to the “Other Features” section of the article to read about the Clock settings. Whenever possible, Newmar provides text like this to answer your frequently asked questions quickly and efficiently.

How do I sanitize my coach’s fresh water system?

For this type of information, you want the Newmar-recommended procedures, rather than generic steps that may be available outside of Newgle. Simply type “sanitize” in the search bar. Results will show the files and links that may include information from product manufacturers, but they also produce knowledge articles. Click on the article about Sanitizing the Fresh Water System to view the step-by-step instructions for this procedure. But that’s not all! For this particular topic, you even have a video available for this topic provided by a Newmar Brand Specialist!

What If I Can’t Find What I’m Looking For?

Now that you know how to navigate, feel free to explore! Forget Google, and surf Newgle to answer your coach-related questions!

Just like the RV industry, our site is always growing, changing, and improving. Our dedicated, full-time Newgle staff is working diligently to provide you with access to more model- and year-specific information directly from the manufacturers as quickly as we can. Help us prioritize our efforts!

If you have suggestions for a better user experience, or if you are unable to locate the information you need, feel free to contact us:

- Email the Newgle team: newgle@newmarcorp.com
- Email the Customer Service team: customerservice@newmarcorp.com
- Call to speak to a Customer Service Brand Specialist: **1-800-731-8300** (option #2)

Newgle Registration and Login Assistance

This article provides information about registration and login assistance for Newgle, Newmar’s online knowledgebase.

How Do I Register For Newgle?

Visit Newgle at <https://newgle.newmarcorp.com> to register for an account.

CUSTOMER ACCOUNTS

If you own a Newmar coach, click the link associated with an owner account, “Coach Owner Account Request.” You will be asked to provide your coach information and some basic contact information, allowing the Newgle Team to verify ownership and set up an account just for you!

Once your account has been created, you will receive a verification email, which will include your new username and a link to create a password. The email address you provide when registering for an account will be used as your username, as well as for all Newgle-related communication, including account credentials, password resets, or any special updates from the Newgle team.

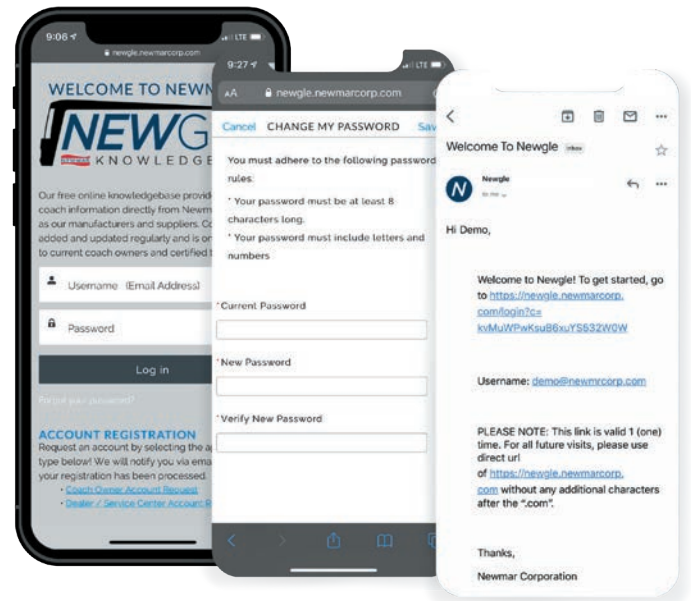

IMPORTANT

This link is only valid one time. Please use the direct URL - <http://newgle.newmarcorp.com> - for future access to the site.

If you already have a Newgle account but have since purchased a different coach, please request a new account to ensure that we have the most up-to-date information in our system. Your login credentials may or may not change pending the newly provided email address.

LOGOUT

End your Newgle session quickly with the click of a button.

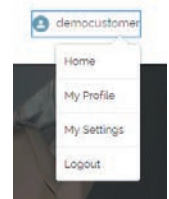

Having Trouble Logging In?

After three failed login attempts, your account will become locked for 15 minutes. Wait 15 minutes, and try to login again. If you forget or lose your password, or if it is no longer working, you can reset it at any time from the login screen.

Click on the “Forgot Your Password?” link, and enter your username (the email address you used when registering for your account), then click or tap “Continue.” You will receive an email with a link to reset your password. Remember, this link is only valid one time. Please use the direct URL - <https://newgle.newmarcorp.com> - for future access to the site.



IMPORTANT

You will be asked to change your password every 180 days to ensure the highest level of security available. A new password cannot match any of the previously-used three passwords. When prompted, follow the onscreen instructions to create a new password that meets all of the requirements.

IMPORTANT

Your Newgle account may be deactivated after six months of inactivity. Newmar will provide notice prior to deactivation using the email address displayed in your profile.

If you have any questions regarding your account, or if you wish to re-activate your Newgle account, please email the Newgle Team at newgle@newmarcorp.com.

Contacting Newmar

This article provides contact information for the Customer Service, Parts, Sales, Newgle, and NewPro departments at Newmar.

Before You Reach Out To Us...

We have built a large pool of online tools and content to help RV'ers and Newmar customers alike. Explore Newgle and see if there's a resource to help solve your concern.

Customer Service

If you would like to speak to a Newmar Customer Service Representative, please call **1-800-731-8300** (option #2) or email customerservice@newmarcorp.com. For more information, visit the Parts and Support page on Newmar's website.

If you wish to schedule maintenance work, schedule service work, or order parts you should notify your local authorized Newmar Service Center to set up an appointment. If you are unsure of the location of the closest authorized Service Center, contact Newmar Customer Service.

Parts

For parts inquiries, refer to the NewPar (formerly ComNet) parts catalog or contact the parts department at **1-800-731-8300** (option #1).

Newgle

For questions pertaining to the Newgle knowledgebase, email newgle@newmarcorp.com. For coach-specific information or inquiries, please contact Customer Service.

Sales (Factory Tour)

To find out details about the Newmar factory tours, or to contact the Newmar Sales department, call **1-800-852-1731** or visit the Factory Tour page on Newmar's website.

Shipping/Mailing Address

Newmar Corporation
355 N Delaware Street
PO Box 30
Nappanee, IN 46550-0030



WHEN YOU KNOW THE DIFFERENCE.™





SAFETY

This chapter provides information about Newmar's compliance requirements, placards and labels, and driving safety. It also includes details about emergency exits and installed safety components (smoke, propane, and carbon monoxide detectors).

IMPORTANT

Any of the following quick start instructions provided by Newmar should not take the place of the manufacturer's complete documentation. Refer to Newgle for more information about safety-related components offered for your coach's model year.

Safety Resources and Compliance Requirements

This article provides information about Newmar's safety and compliance requirements.

Resources

- Recreation Vehicle Safety and Education Foundation (RVSEF)
- Transport Canada (TC)
- National Highway Traffic Safety Administration (NHTSA)

Compliance Requirements

Newmar motorhomes meet or exceed compliance for the following agencies:

UNITED STATES

- Federal Motor Vehicle Safety Standards (FMVSS)
- Nebraska and Washington State Seals
- National Fire Protection Association (NFPA) 1192 through Recreation Vehicle Industry Association (RVIA)
- National Fire Protection Association (NFPA) 70 National Electrical Code
- Ford Qualified Vehicle Modifiers (QVM) (Ford Chassis Only)
- Carb Compliant Phase 2

CONTACTING NATIONAL HIGHWAY TRAFFIC SAFETY ADMINISTRATION (NHTSA)

Mailing Address:

NHTSA Headquarters
1200 New Jersey Avenue SE
West Building
Washington, DC 20590

Telephone:

800-424-9153 (Hearing-Impaired)
888-327-4236 (Toll free)

Online:

<https://www.nhtsa.gov/recalls>

IMPORTANT

If you believe that your vehicle has a significant defect which could cause a crash or could cause injury or death, inform the National Highway Traffic Safety Administration (NHTSA) or Transport Canada (TC), and Newmar Corporation immediately.

CANADA

- Canada Motor Vehicle Safety Standards (CMVSS)
- QAI Laboratories is Newmar's listing agent

CONTACTING TRANSPORT CANADA

Mailing Address:

Transport Canada - ASFAD
330 Sparks Street
Ottawa, ON K1A 0N5

Telephone:

819-994-3328 (Ottawa - Gatineau area or internationally)
800-333-0510 (Toll free)

Online:

<http://www.tc.gc.ca/recalls>

Adresse postale :

Transports Canada -ASFAD
330, rue Sparks
Ottawa (Ontario) K1A 0N5

Téléphone: 819-994-3328 (dans la région de Ottawa-Gatineau et à l'extérieur du pays)

Sans frais: 1-800-333-0510 (au Canada)

Internet:

<http://www.tc.gc.ca/rappels>

Placards and Labels

A variety of placards and labels are located throughout your coach. These are installed to aid in the operation of a component, or to warn of potential dangers while operating a specific appliance, accessory, or system.

⚠ IMPORTANT

Reading, understanding, and heeding all such labels and placards is critical to the safe, efficient use of your coach.

Driving Safety

Before Driving Away

Provides a brief list of procedures that will aid in your driving safety and extend the life of your coach.

⚠ WARNING

Prior to driving your vehicle, be sure you have read your entire owner's guide and that you understand your vehicle's equipment completely. Read and understand all of the instructions and precautions in this owner's guide and the chassis manufacturer owner's manual before operating your new coach.

Listed below are some safety precautions that must be adhered to while your coach is in motion. These precautions, as well as others that involve possible damage to equipment, are also listed in the appropriate areas in this manual.

There are various adjustments that need to be made prior to starting and moving the vehicle. Among them are the driver's seat, the tilt steering, and the exterior side view mirrors, as well as checking the rear view monitoring system. In addition, the following procedures will aid in your driving safety and extend your equipment's life.

- Windows, mirrors, and light lenses are to be clean and unobstructed.
- Tires should be checked for proper cold inflation pressure.
- Wheel lug nuts should be checked for proper tightness.
- Fluid levels, including engine oil, transmission fluid, coolant, power steering fluid, brake fluid, and windshield washer solvent, should be checked and filled, if necessary.
- Disconnect the unit from power. Store the sewer and water supply hoses, as well as shoreline power cords.
- Secure all cargo in the storage compartments in the event of a sudden stop.
- Verify that the step has retracted prior to engine ignition.
- Know the overall height of your coach to avoid overhead damage from low clearance bridges, overpasses, awnings, etc.

Dangerous Driving Conditions and Severe Weather Safety

This article provides safety tips to follow for driving in dangerous conditions or encountering severe weather while using the coach.

Always Stay Informed

Avoid weather-related surprises by checking the forecast each day.

- If severe weather is a possibility, check a local weather website or phone application frequently for updates in your area. The National Weather Service (<https://www.weather.gov/>) is a great resource to check local forecasts. It may also be a wise decision to invest in a weather radio to receive up-to-date forecasts directly from the NWS.
- Know where you are at all times. Knowing which county you are in will help you know what is coming and when.
- For any extended stays, find out where the storm warning systems and alarms are located. It may also be helpful to know the days and times when these are typically tested to avoid any unnecessary concern.

Prepare Ahead of Time

If poor weather is in the forecast, preparing ahead of time can save you a lot of hassle.

- Check the function of your windshield wipers, brake lights, and headlights. Make sure you have plenty of fuel and that your tire pressure is correct to avoid hydroplaning.
- In the event of snow, freezing rain, or ice, make sure your coach is properly winterized. If you do not have to travel, wait until the roads are clear before proceeding to your next stop.

WARNING

The cruise control is not to be operated on icy roads, extremely wet roads, winding roads, heavy traffic, or in any other traffic situation where a constant speed cannot be maintained.

WARNING

While driving on slippery surfaces, use care when accelerating or decelerating. Skidding and loss of vehicle control may be the result of abrupt changes in speed.

- If parked, try to avoid surrounding trees or power lines. Secure all loose belongings that could blow away. Bring them inside the RV or store them securely in a basement compartment before a storm hits to prevent physical damage to you or the RV.
- Retract all awnings to prevent wind and water damage.
- Find out where local storm shelters are and have an evacuation plan in place.
- Pack an emergency bag of necessities (i.e. medical supplies, important documents, cell phone chargers, water, non-perishable food, etc.).

Take Cover

Your coach can protect you from most severe weather, but it is not always the safest option.

- If straight line winds or the threat of tornado(s) are in the forecast, leave the RV, and find a local storm shelter.
- If you are driving and severe weather or a tornado pops up, park the RV in a safe location (not under a bridge or overpass), lay down away from windows, and cover your head.
- In the event of heavy rain or floodwaters, do not attempt to drive through water that is crossing a road. **TURN AROUND; DON'T DROWN.**

WARNING

Driving through water deep enough to wet the brakes may affect the stopping distance or cause the vehicle to pull to one side. If you have driven through deep water, check the brake operation in a safe area to be sure they have not been affected.

WARNING

Never operate a vehicle if a difference in braking efficiency is noticeable. Extreme terrain and adverse weather may affect the handling and/or performance of your vehicle.

- If there is a threat (even a small one) of severe weather, plan indoor activities in a safe, sheltered place. Be prepared; have a plan in place; and use good judgment.

Seat Belt Safety

This article provides information about the seat belts installed in the coach, including operation and care and maintenance instructions.

One of the most important safety features in your vehicle is the restraint system. Research has shown that seat belts save lives. And they can reduce the seriousness of injuries in a collision. Some of the worst injuries happen when people are thrown from the vehicle. Everyone in a motor vehicle needs to be buckled up at all times.

WARNING

It is extremely dangerous to ride in a cargo area, inside or outside of a vehicle. In a collision, people riding in these areas are more likely to be seriously injured or killed. Do not allow people to ride in any area of your vehicle that is not equipped with seats and seat belts. Be sure everyone in your vehicle is in a seat and is using a seat belt properly.

How To Operate Your Seat Belts and Restraint System

⚠ WARNING

If you wear your safety belt improperly, both the effectiveness and comfort will decrease.

LAP/SHOULDER COMBINATION RESTRAINTS

1. Enter the vehicle and close the door. Sit back, and adjust the seat.
2. The latch plate of the belt is above the back of your seat. Grasp the latch plate, and pull out the belt. Slide the latch plate up the webbing as far as necessary to make the belt go around your lap.
3. When the belt is long enough to fit, insert the latch plate into the buckle until you hear a “click.”
4. Position the lap belt across your thigh, below your abdomen. If you need the lap portion tighter, pull up a bit on the shoulder part. A snug belt reduces the risk of sliding under the belt in a collision. Position the shoulder belt on your chest so that it is comfortable and not resting on your neck. The retractor will withdraw any slack in the belt.
5. To release the belt, push the release button on the buckle.



⚠ NOTICE

Some shoulder belts can be adjusted upward or downward to help position the belt away from your neck. Push on the anchorage cover to release it, and then move it up or down to the position that serves you best.

⚠ IMPORTANT

Everyone in your vehicle needs to be buckled up at all times. Every state in the United States and all Canadian provinces require that small children ride in proper restraint systems. This is the law, and you can be prosecuted for ignoring it.

LAP BELT RESTRAINTS WITHOUT A SHOULDER HARNESS

⚠ WARNING

Always wear your seat belt when the vehicle is in operation.

1. Slide the latch up the webbing as far as necessary to make the belt go around your lap.
2. Insert the latch plate into the buckle until you hear a “click.”
3. Adjust and position the belt low and snug across your hips by removing the slack from the belt.
4. To release the belt, push the release button on the buckle.

There are different sizes and types of restraints for children from newborn to near-adult size children. Use the restraint that is correct for your child:

- The restraint must be appropriate for your child’s weight and height. Check the label on the restraint for this, too.
- Carefully follow the instructions that come with the restraint. If you install the restraint improperly, it may not work when you need it.
- Buckle the child into the restraint exactly as the manufacturer’s instructions have directed.

⚠ IMPORTANT

Each belt is intended to restrain only one person at a time. Do not put two people under one belt.

⚠ CAUTION

Never attempt to restrain a child in your lap using the lap belt around both you and the child. The child could be severely injured or killed in the event of a collision.

⚠ IMPORTANT

Seat belts are matched sets. Do not mix or use this belt or parts of this belt with other types of seat belts.

How To Maintain Your Seat Belts and Restraint System

Periodically examine your restraint equipment to be sure it functions correctly and to be sure there are no worn or broken components that either needs repair or replacement. Damaged parts must be replaced immediately. Do not disassemble or modify the system.

Restraint equipment must be replaced after an accident if they have been damaged. If there is any question regarding belt or retractor condition, replace the belt. It is a good idea to have your restraint system inspected during each periodic scheduled maintenance session. If the belts need cleaning, use a mild soap solution or lukewarm water. Do not remove the belts from the vehicle to wash them.

Fire Safety

This article provides information about the smoke detectors and fire extinguishers installed in the coach.

The possibility of fire exists in all areas of life, and the recreational lifestyle is no exception. Recreational vehicles are complex machines made up of many materials, some of which are flammable. Like most hazards, the possibility of fire can be minimized, if not totally eliminated by recognizing the danger and practicing common sense safety and maintenance habits. For safety reasons, your unit is furnished with both a fire extinguisher and a smoke alarm.

WARNING

A frayed or torn belt could rip apart in a collision and leave you with no protection. Inspect the belt system periodically, checking for cuts, frays, or loose parts. Damaged parts must be replaced immediately. Do not disassemble or modify the system. Seat belt assemblies must be replaced after an accident if they have been damaged (bent retractor, torn webbing, etc.)

WARNING

Do not bleach, dye or clean the belts with chemical solvents or abrasive cleaners. This may severely weaken the fabric. In a crash, they might not be able to provide adequate protection.

 WARNING

Test smoke alarm operation after vehicle has been in storage, before each trip, and at least once per week during use. Failure to do so can result in death or serious injury.

 AVERTISSEMENT

Vérifier l'avertisseur de fumée si le véhicule a été entreposé, avant chaque déplacement et au moins une fois par semaine en service. L'absence de vérification peut entraîner des blessures graves ou la mort.

DD-94

 DANGER

Vehicles and equipment powered by internal combustion engines and placed in recreational vehicles can cause carbon monoxide poisoning or asphyxiation, which could result in death or serious injury. The flammable liquids used to power these items can cause a fire or explosion, which can result in death or serious injury.

To reduce risk:

1. Do not ride in the vehicle storage area when vehicles are present.
2. Do not sleep in the vehicle storage area when vehicles are present.
3. Close doors and windows in walls of separation (if installed) when any vehicle is present.
4. Run fuel out of engines of stored vehicles after shutting off fuel at the tank.
5. Do not store, transport, or dispense fuel inside this vehicle.
6. Open the windows, openings, or air ventilation systems provided for venting the transportation area when vehicles are present.
7. Do not operate propane appliances, pilot lights, or electrical equipment when motorized vehicles are present.

DANGER

If a fire occurs in the vehicle, evacuate the vehicle as quickly and as safely as possible. Consider the cause and the severity of the fire and the risk involved before trying to extinguish it. If the fire is major or fuel fed, move away from and stand clear of the vehicle and wait for emergency assistance to arrive.

Smoke Detectors

The smoke detector installed in your coach is operated on a 9 volt battery. The smoke detector is mounted on the ceiling in the living area of the unit. Read the operating instructions for details on the testing and care for this important safety device.

Test the smoke detector after the unit has been in storage, before each trip, and at least once a week during use. Check your smoke detector for the manufacturer's expiration date. The battery needs to be tested periodically and replaced once a year and/or when the low battery signal sounds.

When cleaning the case on any of the detectors, use a damp cloth or paper towel. Do not spray cleaners or wax directly into the case as it may cause false alarms.

IMPORTANT

The detector should never be disabled because of nuisance or false alarm from cooking smoke or a dusty furnace. Ventilate the unit with fresh air and the alarm will shut off. Never disconnect or remove the battery from the smoke alarm.

Fire Extinguishers

The fire extinguisher is rated for Class B (grease, gasoline, diesel fuel, flammable liquids) and Class C (electrical) fires. These are the most common types of fires in vehicles. Fire extinguishers are mechanical, pressurized devices. Care must be exercised when they are handled.

The extinguisher should be inspected at least once a month. More frequent inspections may be required if the extinguisher is exposed to the weather or to possible tampering. Do not test the extinguisher by partially discharging, as it will cause a loss of pressure. Your fire extinguisher must be maintained as the operator's manual instructs for proper and safe operation.

Read the operator's manual and the instructions on the fire extinguisher. Be sure to know how and when to use the extinguisher and where it is located.

DANGER

Failure to comply could result in an increased risk of fire, explosion, asphyxiation, serious injury, or death.

BRK Smoke Detector Operation (Model: FG250RV)

This article provides basic operation instructions for a BRK smoke detector (Model: FG250RV).

If The Smoke Alarm Sounds

During an alarm, you will hear a loud, repeating horn pattern: 3 beeps, pause, 3 beeps, pause; and the Red LED will flash rapidly.

⚠ WARNING

If the unit alarms and you are not testing the unit, it is warning you of a potentially dangerous situation that requires your immediate attention. NEVER ignore any alarm. Ignoring the alarm may result in injury or death.

⚠ WARNING

Never remove the batteries from a battery operated Smoke Alarm to stop an unwanted alarm (caused by cooking smoke, etc.). Removing batteries disables the alarm so it cannot sense smoke, and removes your protection. Instead open a window or fan the smoke away from the unit. The alarm will reset automatically.

⚠ WARNING

If the unit alarms get everyone out of the house immediately.

Regular Maintenance

This unit has been designed to be as maintenance free as possible, but there are a few simple things you must do to keep it working properly.

- Test it at least once a week.
- Clean the Smoke Alarm at least once a month; gently vacuum the outside of the Smoke Alarm using your household vacuum's soft brush attachment. Test the Smoke Alarm. Never use water, cleaners or solvents since they may damage the unit.
- If the Smoke Alarm becomes contaminated by excessive dirt, dust and/or grime, and cannot be cleaned to avoid unwanted alarms, replace the unit immediately.
- Relocate the unit if it sounds frequent unwanted alarms. See "Locations to Avoid for Smoke Alarms" for details.
- When the battery becomes weak, the Smoke Alarm unit will "chirp" about once a minute (the low battery warning). This low battery warning should last 7 days, but you should replace the battery immediately to continue your protection. Note: If locking pin is engaged see "Locking Feature" section for unlocking instructions.

Weekly Testing

It is important to test this unit every week to make sure it is working properly. Using the test button is the recommended way to test this Smoke Alarm. Press and hold the test button on the cover of the unit until the alarm sounds (the unit may continue to alarm for a few seconds after you release the button). If it does not alarm, make sure the unit is receiving power and test it again. If it still does not alarm, replace it immediately. During testing you will hear a loud, repeating horn pattern: 3 beeps, pause, 3 beeps, pause; and the Red LED will flash rapidly.

⚠ WARNING

Never use an open flame of any kind to test this unit. You might accidentally damage or set fire to the unit or to your home. The built-in test switch accurately tests the unit's operation as required by Underwriters Laboratories, Inc. (UL).

⚠ WARNING

If the alarm ever fails to test properly, replace it immediately.

⚠ CAUTION

Do not stand close to the alarm when the horn is sounding. Exposure at close range may be harmful to your hearing. When testing, step away when horn starts sounding.

Replacing The Battery

Your Smoke Alarm requires one standard 9V battery. The following batteries are acceptable as replacements: Duracell #MN1604, Eveready (Energizer) #522. You may also use a Lithium battery like the Ultralife U9VL-J, U9VL-J-P for longer service life between battery changes. These batteries are available at many local retail stores.

To lock/unlock the cover to the base:

1. Using needle-nose pliers or a utility knife, detach locking pin from back of alarm base.
2. Insert locking pin into the slot located on the front of the alarm as shown in the diagram.
3. Remove pin to unlock and replace battery.

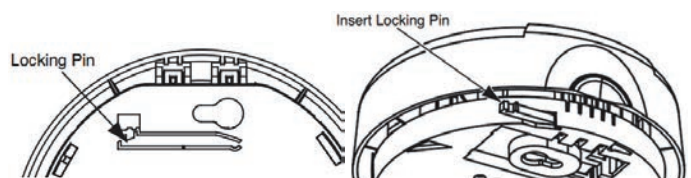

Source(s): BRK Battery Powered Smoke Alarm User's Manual

Product(s): BRK Electronics Smoke Detector (Model: FG250RV, Newmar Part Number: 119606)

Kidde 10 lbs. Fire Extinguisher UL Operation (Model: 466295MTL)

This article provides basic operation instructions for a Kidde fire extinguisher (Model: 466295MTL).

How To Use Fire Extinguishers

Stand 5 feet away from the fire and follow the four-step PASS procedure recommended by the National Fire Protection Association:

- **P** - Pull the pin and hold the extinguisher with the nozzle pointing away from you.
- **A** - Aim low at the base of the fire.
- **S** - Squeeze the lever slowly and evenly to discharge the extinguishing agent. When the agent first hits the fire, the fire may briefly flare up. This should be expected.
- **S** - Sweep the nozzle from side to side, moving carefully toward the fire. Keep the extinguisher aimed at the base of the fire.

Source(s): Kidde Fire Extinguisher Owner's Manual

Product(s): Kidde 10 lbs. Fire Extinguisher UL (Model: 466295MTL, Newmar Part Number: 143817)

When To Use Fire Extinguishers

It's important to remember that fire extinguishers are only one element of a complete fire survival plan. Only use your extinguisher after making sure:

- All residents of the home have been evacuated to safety
- The fire department has been notified
- There is a clear exit behind the person using the extinguisher

Use your extinguisher only to keep a small self-contained fire from growing, only when the room is not filled with smoke, or to create a safe pathway out of the home. Be sure to read the instructions and become familiar with your fire extinguisher's parts and operation before a fire breaks out.

Carbon Monoxide Safety

This article provides information about the safe use of carbon monoxide-producing coach components. Carbon monoxide is a colorless, tasteless, odorless gas. It is a by-product of the burning of fossil fuels (gasoline, propane gas, diesel fuel, etc.). The chassis and generator engines, furnaces, water heater, propane gas refrigerator, and range produce carbon monoxide constantly while they are operating.

Carbon Monoxide Poisoning

If you, or anyone else, experience any of the following carbon monoxide poisoning symptoms, exit the coach immediately. Seek medical attention if the symptoms persist. Shut down the coach, and do not operate it until it has been thoroughly inspected and repaired.

- Dizziness
- Nausea
- Vomiting
- Muscular twitching
- Throbbing in the temples
- Inability to think coherently
- Weakness and/or sleepiness
- Intense headaches

DANGER

Carbon monoxide is deadly. Read and understand the following precautions, as well as any warning labels in your coach, to protect yourself and others from the effects of carbon monoxide poisoning.

WARNING

Do not sleep in this area. Carbon monoxide or other harmful vapors could enter the area through the floor openings, which could result in death or serious injury.

AVERTISSEMENT

Ne pas dormir dans cette aire. Du monoxyde de carbone ou d'autres vapeurs nocives pourraient y pénétrer par des ouvertures dans le plancher et entraîner des blessures graves ou la mort.

DANGER

Vehicles and equipment powered by internal combustion engines and placed in recreational vehicles can cause carbon monoxide poisoning or asphyxiation, which could result in death or serious injury. The flammable liquids used to power these items can cause a fire or explosion, which can result in death or serious injury.

To reduce risk:

1. Do not ride in the vehicle storage area when vehicles are present.
2. Do not sleep in the vehicle storage area when vehicles are present.
3. Close doors and windows in walls of separation (if installed) when any vehicle is present.
4. Run fuel out of engines of stored vehicles after shutting off fuel at the tank.
5. Do not store, transport, or dispense fuel inside this vehicle.
6. Open the windows, openings, or air ventilation systems provided for venting the transportation area when vehicles are present.
7. Do not operate propane appliances, pilot lights, or electrical equipment when motorized vehicles are present.

WARNING

Do not block the tailpipes or exhaust ports. Do not situate the vehicle in a place where the exhaust gases have any possibility of accumulating either outside, underneath, or inside your vehicle or any nearby vehicles. Outside air movements can carry exhaust gases inside the vehicle through windows or other openings remote from the exhaust outlet. Operate engines, carbon monoxide-producing systems, or components only when safe dispersion of exhaust gases can be assured. Monitor outside conditions to be sure that exhaust continues to be dispersed safely.

Carbon Monoxide (CO) Detectors

The detector is equipped with a “sensor activation strip,” which must be removed for the detector to operate properly. This should have been done during the dealer’s Pre-Delivery Inspection. Please check the detector to verify that the activation strip has been removed. The CO detectors are self-contained and do not require any maintenance other than normal cleaning and dusting.

Install battery or batteries into the battery holder, and observe the polarity. After approximately 30 seconds, the battery-operated detector will begin monitoring for carbon monoxide, making the device operational. The test/reset button is used to test the detector’s electronics and reset the detector after an alarm. Test the detector weekly.

⚠ WARNING

Under no circumstance should you operate any engine while sleeping. When you are sleeping, you are not able to monitor outside conditions to assure that engine exhaust does not enter into the coach. Check the exhaust system frequently for damage. If damage is found, do not operate the system. Never modify the exhaust system(s) in any way.

BRK (First Alert) Carbon Monoxide Alarm Operation (Model: CO250RVA)

This article provides basic operation instructions for a BRK (First Alert) carbon monoxide alarm (Model: CO250RVA).

How Your CO Alarm Works

A CO Alarm measures the CO levels in the air. It will alarm if CO levels rise quickly (if the heat exchanger on your furnace breaks, for example), or if CO is consistently present (a slow CO leak on a fuel-burning appliance).

This Carbon Monoxide alarm features a permanently installed sensor and an 85 dB alarm horn. It also has a silence feature to temporarily quiet the alarm horn.

If The CO Alarm Sounds

⚠ WARNING

Actuation of your CO Alarm indicates the presence of carbon monoxide (CO) which can kill you. In other words, when your CO Alarm sounds, you must not ignore it!

Welcome Chirp	Horn chirps and light blinks once when batteries are first connected.
Alarm Receiving Battery Power	Light flashes every minute. Horn is silent.
Low Battery Warning	The light continues to flash (RED) and the horn also "chirps" once every minute. This warning should last for up to 30 days, but you should replace the batteries as soon as possible.
During Testing	Light flashes RED with the horn pattern (4 beeps, pause, 4 beeps), simulating a CO Alarm condition.
CO Alarm	Sensor has detected enough CO to trigger an alarm. Light flashes rapidly and horn sounds loudly (repeating 4 beeps, pause). During an alarm, move everyone to a source of fresh air. DO NOT move the CO Alarm!
CO Alarm Requires Service (Malfunction Signal)	The light flashes (RED) and the horn sounds 3 "chirps" every minute. CO Alarm needs to be replaced.
CO Alarm Has Reached Its End of Life	The light flashes (RED) and the horn sounds 3 "chirps" every minute. CO Alarm needs to be replaced.

IF THE ALARM SIGNAL SOUNDS

1. If you hear the alarm horn and the Red light is flashing, move everyone to a source of fresh air. DO NOT disconnect the battery from the CO Alarm! Do a head count to check that all persons are accounted for. Do not re-enter the premises, or move away from the open door or window until the emergency services responder has arrived, the premises have been aired out, and your CO Alarm remains in its normal condition.
2. Call your emergency services, fire department or 911.
3. After following steps 1-2, if your CO Alarm reactivates within a 24-hour period, repeat steps 1-2 and call a qualified appliance technician to investigate for sources of CO from fuel-burning equipment and appliances, and inspect for proper operation of this equipment. If problems are identified during this inspection have the equipment serviced immediately.

Using The Silence Feature

WARNING

The Silence Feature is for your convenience only and will not correct a CO problem. Always check your home for a potential problem after any alarm. Failure to do so can result in injury or death.

WARNING

NEVER remove the batteries from your CO Alarm to silence the horn. Use the silence feature. Removing the batteries removes your protection!

The Silence Feature is intended to temporarily silence your CO Alarm's alarm horn while you correct the problem—it will not correct a CO problem. While the alarm is silenced it will continue to monitor the air for CO.

When CO reaches alarm levels the alarm will sound—repeating horn pattern: 4 beeps, a pause, 4 beeps, etc. Press and hold the Test/Silence button until the horn is silent. The initial Silence cycle will last approximately 4 minutes.

NOTE: After initial 4-minute Silence cycle, the CO Alarm re-evaluates present CO levels and responds accordingly. If CO levels remain potentially dangerous—or start rising higher—the horn will start sounding again.

WHEN THE DETECTOR IS SILENCED:

- IF the CO alarm is silent for only 4 minutes, then starts sounding loudly - 4 beeps, pause, 4 beeps, pause... THEN the CO levels are still potentially dangerous.
- IF the CO alarm remains silent after you pressed the Test/Silence button... THEN the CO levels are dropping.

SILENCING THE LOW BATTERY WARNING

This silence feature can temporarily quiet the low battery warning “chirp” for up to 8 hours. You can silence the low battery warning “chirp” by pressing the Test/Silence button. The horn will chirp, acknowledging that the low battery silence feature has been activated.

After 8 hours, the low battery “chirp” will resume. Replace the battery as soon as possible; this unit will not operate without battery power!

To deactivate this feature: Press the Test/Silence button again. The unit will go into Test Mode and the low battery warning will resume (LED flashes and unit sounds “chirp” once a minute.)

If you cannot silence the low battery warning, replace the battery immediately.

SILENCING THE END OF LIFE SIGNAL

This silence feature can temporarily quiet the End of Life warning “chirp” for up to 2 days. You can silence the End of Life warning “chirp” by pressing the Test/Silence button. The horn will chirp, acknowledging that the End of Life silence feature has been activated.

- After approximately 2 days, the End of Life “chirp” will resume.
- After approximately 2-3 weeks the End of Life warning cannot be silenced.

Testing and Maintenance

WEEKLY TESTING

WARNING

Test the CO Alarm once a week. If the CO Alarm ever fails to test correctly, have it replaced immediately! If the CO Alarm is not working properly, it cannot alert you to a problem.

WARNING

Do NOT stand close to the Alarm when the horn is sounding. Exposure at close range may be harmful to your hearing. When testing, step away when horn starts sounding.

Push and hold the Test/Silence button on the cover until the LED flashes. The alarm horn will sound 4 beeps, a pause, then 4 beeps. The ALARM (RED) light will flash.

The alarm sequence should last 5-6 seconds. If it does not alarm, make sure fresh batteries are correctly installed, and test it again. If the unit still does not alarm, replace it immediately.

IF THE ALARM DOES NOT TEST PROPERLY:

1. Make sure the battery is installed correctly.
2. Be sure the Alarm is clean and dust-free.
3. Install a fresh 9V battery and test the Alarm again.

WARNING

DO NOT try fixing the Alarm yourself - this will void your warranty! Install a new CO Alarm immediately.

WARNING

The Test/Silence button is the only proper way to test the CO Alarm. NEVER use vehicle exhaust! Exhaust may cause permanent damage and voids your warranty.

REGULAR MAINTENANCE

To keep the CO Alarm in good working order:

- Test it every week using the Test/Silence button.
- Vacuum the CO Alarm cover once a month, using the soft brush attachment. Never use water, cleaners, or solvents, since these may damage the unit. Test the CO Alarm again after vacuuming.
- Replace the batteries when the CO Alarm “chirps” about every minute (the low battery warning). The low battery warning should last for 30 days, but you should replace the battery immediately to continue your protection.

CHOOSING A REPLACEMENT BATTERY:

This CO Alarm requires one 9V alkaline battery. The following batteries are acceptable as replacements: Alkaline Batteries — Duracell MN1604 or Energizer 522; Lithium Batteries — Ultralife U9VL-J. These replacement batteries are commonly available at local retail stores.

Propane Safety

This article provides details about the propane fuel system in a Newmar coach, including propane safety and maintenance.

Your coach may be equipped with an ASME (American Society of Mechanical Engineers) approved propane tank. This tank is controlled with an automatic pressure regulator. The propane tank contains liquid petroleum gas under high pressure. As the fuel is used, the liquid gas vaporizes and passes through the tank valve to a regulator that automatically reduces the pressure. The low-pressure gas is then distributed to the appliances throughout the pipe manifold system.

The components relating to the propane gas system in your coach have been approved for use in recreational vehicles by a nationally recognized testing laboratory. Propane gas is a clean-burning dependable fuel when properly handled.

⚠️ IMPORTANT

While in high altitudes or extreme cold weather, a gas shortage may be experienced. Running one appliance at a time can help adjust to this problem.

⚠️ DANGER

Exhaust gases contain carbon monoxide (an odorless, colorless, and poisonous gas) produced by burned gasoline, diesel, or propane gas. Items such as the range, furnace, water heater, refrigerator, chassis engine, or generator engine can produce these gases. These fumes should not be inhaled.

⚠️ WARNING

Always use the exact batteries specified by this User's Manual. DO NOT use rechargeable batteries. For products requiring multiple batteries, replace all batteries of a set at the same time. Do Not Mix Old and New Batteries. Clean the battery contacts and also those of the device prior to battery installation. Install batteries correctly with regard to polarity (+ and -).

⚠️ WARNING

Please dispose of or recycle used batteries properly, following any local regulations. Consult your local waste management authority or recycling organization to find an electronics recycling facility in your area. DO NOT DISPOSE OF BATTERIES IN FIRE. BATTERIES MAY EXPLODE OR LEAK.

Source(s): BRK Battery Powered Carbon Monoxide Alarm (CO250RVA-48B) User's Manual

Product(s): BRK Electronics Carbon Monoxide Alarm (Model: CO250RVA, Newmar Part Number: 125654)

Propane Safety

⚠️ WARNING

Portable fuel-burning equipment, including wood and charcoal grills and stoves, shall not be used inside the coach, as they can cause fire or asphyxiation. Failure to comply could result in serious injury or death.

PROPANE (LP) DETECTOR

The propane detector in your coach is located in the main living area close to the floor. It is wired to the 12 volt electrical system in your unit and may be controlled by a switch in the front overhead cabinet. Operating instructions and a test button are located on the face of the detector. The propane detector should be tested after the vehicle has been in storage, before each trip, and at least once per week during use.

Never attempt to repair the propane detector. Do not remove the fuse or disconnect wiring to the propane detector. If the propane detector will not function, check for 12 volt power at the detector. If an issue is found, or if the 12 volt electric circuit not operational, repair the 12 volt issue or replace the propane detector.

⚠️ WARNING

Do not use coach with a non-operational LP detector.

Never spray any type of aerosol or cleaner directly onto or into the propane detector. Spraying any type of material into the opening on any of these detectors can render them useless, and would not be covered by the manufacturer's warranty.

Refer to Newgle for more information about your coach's propane (LP) gas detector.

PROPANE WARNING LABELS

IMPORTANT

Read and understand the following precautions, as well as any warning labels in your coach, to protect yourself and others from the risks of operating an LP system.

The following labels regarding propane safety are strategically placed inside of your coach.

<p>⚠ WARNING</p> <p>This propane piping system is designed for use with propane only. Do not connect natural gas to this system. Securely cap inlet when not connected for use. After turning on propane, except after normal cylinder replacement, test propane piping and connections to appliances for leakage with soapy water or bubble solution. Do not use products that contain ammonia or chlorine to test for leaks. May lead to a fire or explosion, which could result in death or serious injury.</p>	<p>⚠ AVERTISSEMENT</p> <p>Cette tuyauterie de propane est conçue pour n'être utilisée qu'avec du propane. Ne pas l'utiliser pour du gaz naturel. Bien capuchonner l'entrée de la tuyauterie lorsque celle-ci n'est pas raccordée. Après avoir ouvert la vanne du propane, sauf lors du remplacement normal du cylindre, faire un essai d'étanchéité de la tuyauterie de propane et des raccords aux appareils à l'aide d'eau savonneuse ou d'une solution qui produit des bulles. Ne pas effectuer d'essai d'étanchéité à l'aide d'ammoniac ou de chlore. Le non-respect de cette instruction peut causer un incendie ou une explosion, ce qui pourrait entraîner des blessures graves ou la mort.</p>	<p>⚠ CAUTION</p> <p>Shut off gas supply before disconnecting appliance.</p>
		<p>⚠ ATTENTION</p> <p>Couper le gaz avant de déconnecter l'appareil.</p>

IF YOU SUSPECT A GAS LEAK

If the detector alarms while in use, or if you smell propane or suspect a gas leak (the odor smells similar to rotten eggs or sulfur), follow the warning labels in your coach.

DANGER

Never test for a leak by lighting a match or having an open flame where you suspect leaking gas.

- Immediately turn off all potential sources of ignition (furnace, water heater, refrigerator, stove/range, etc.), and extinguish any open flames, pilot lights, and all smoking materials.
- Do not touch electrical switches.
- Shut off the propane supply at the container valve(s) or propane supply connection.
- Open doors and other ventilating openings.
- Evacuate the unit, and leave the area until the odor clears.
- Consult an authorized service technician for repairs, as the propane system must be checked and leakage source corrected before using again.

<p>⚠ DANGER</p> <p>IF YOU SMELL PROPANE</p> <ol style="list-style-type: none"> 1. Extinguish any open flames and all smoking materials. 2. Shut off the propane supply at the container valve(s) or propane supply connection. 3. Do not touch electrical switches. 4. Open doors and other ventilating openings. 5. Leave the area until the odor clears. 6. Have the propane system checked and leakage source corrected before using again. <p>IGNITION OF FLAMMABLE VAPORS COULD LEAD TO A FIRE OR EXPLOSION AND RESULT IN DEATH OR SERIOUS INJURY.</p>	<p>⚠ DANGER</p> <p>SI VOUS SENTEZ UNE ODEUR DE PROPANE :</p> <ol style="list-style-type: none"> 1. Éteignez toute flamme nue et tout article pour fumeur. 2. Coupez l'alimentation en gaz de l'appareil au réservoir ou au raccordement d'alimentation. 3. Ne touchez pas aux interrupteurs électriques. 4. Ouvrez les portes et toute autre ouverture de ventilation. 5. Quittez les lieux jusqu'à ce que l'odeur ait disparu. 6. Faites vérifier l'installation et colmater toute fuite avant d'utiliser de nouveau. <p>L'INFLAMMATION DES VAPEURS INFLAMMABLES POURRAIT PROVOQUER UN INCENDIE OU UNE EXPLOSION ET ENTRAÎNER DES BLESSURES GRAVES OU LA MORT.</p>
--	--

Propane Operation

Check the LP level either from the monitor panel in the coach or the gauge on the LP tank to ensure an adequate fuel level.

Make sure the LP valve is open. To open it, turn the valve counterclockwise.

When having the tank filled, or if the coach is in storage, or if LP is not currently needed, turn off the gas at the LP tank by turning the valve clockwise.

The tank fill valve and the 80% bleeder valve should not be tampered with by the user. These valves are for filling purposes and should only be performed at a licensed filling station.

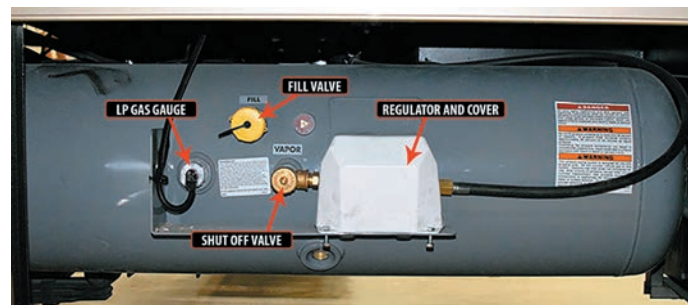

Propane System Maintenance

It is recommended to have the propane system inspected by an authorized service technician at least once a year and after every extended trip. This system is tested by both the manufacturer and the dealer; however, leaks may be caused by travel vibrations.

FILLING THE PROPANE SYSTEM

Tank filling should only be performed by trained professionals. Prior to filling the propane tank, turn off all flame or spark-producing appliances, extinguish any smoking items, and turn off the coach engine.

WARNING

Inspect the propane fill valve for foreign materials before refueling. Introducing foreign material into the fill valve may cause leaking or overfilling, resulting in uncontrolled gas flow and a fire or explosion.

WARNING

While refilling the fuel or propane tank, the engine must be off, all pilot lights must be extinguished, and appliances turned off. The vehicle should be as level as possible, and the service valve should be turned off. Smoking is also prohibited at this time.

⚠ WARNING

Shut off the propane gas valve when refueling to avoid potential danger from pilot lights igniting fuel fumes. Some appliances, such as the refrigerator, water heater, and furnace, have DSI (direct spark ignition) boards, so it is important that you turn the appliances off when the propane gas is turned off. The ignition in the appliances may continue to spark even if there is no propane gas available.

⚠ IMPORTANT

All protective covers and caps must be replaced after filling the propane system. Once the valve is closed, securely latch the propane door.

⚠ WARNING

Propane gas is extremely flammable. Propane gas containers, gasoline, or other flammable liquids shall not be placed or stored inside the vehicle. Propane cylinders are equipped with safety devices that relieve excessive pressure by discharging propane to the atmosphere. Failure to comply could result in serious injury or death.

⚠ WARNING

Do not fill propane container(s) to more than 80 percent capacity. Overfilling the propane container can result in uncontrolled propane flow, which can cause fire or explosion. A properly filled container contains approximately 80 percent of its volume as liquid propane. Failure to comply could result in serious injury or death.

⚠ WARNING

Do not fill propane container(s) to more than 80 percent of capacity. A properly filled container contains approximately 80 percent of its volume as liquid propane. Overfilling the propane container(s) can result in uncontrolled propane flow, which could lead to a fire or explosion and result in death or serious injury.

⚠ WARNING

This propane piping system is designed for use with propane only. Do not connect natural gas to this system. Securely cap inlet when not connected for use. After turning on propane, except after normal cylinder replacement, test propane piping and connections to appliances for leakage with soapy water or bubble solution. Do not use products that contain ammonia or chlorine to test for leaks. May lead to a fire or explosion, which could result in death or serious injury.

⚠ AVERTISSEMENT

Ne pas remplir les bouteilles de propane à plus de 80 % de leur capacité. Une bouteille remplie de manière appropriée est remplie de propane liquide à environ 80 pour cent de son volume. Un remplissage excessif peut entraîner un écoulement incontrôlé du propane, ce qui pourrait provoquer un incendie ou une explosion et causer des blessures graves ou la mort.

⚠ AVERTISSEMENT

Cette tuyauterie de propane est conçue pour le propane uniquement. Ne pas raccorder de gaz naturel à cette tuyauterie. Obturer l'orifice d'entrée lorsque le réservoir n'est pas utilisé. Une fois le robinet d'alimentation ouvert, sauf après un remplacement normal de la bouteille, vérifier l'étanchéité de la tuyauterie et des raccords avec une eau savonneuse ou autre solution faisant des bulles. Ne pas utiliser de produits contenant de l'ammoniac ou du chlore pour les essais d'étanchéité. Peut provoquer un incendie ou une explosion et causer des blessures graves ou la mort.

CO-251

⚠ WARNING

When removing or servicing any gas appliance, close the main gas valve on the propane tank to prevent dangerous gas leakage that could result in an explosion and possible serious injury. If a gas leak is suspected, have the system inspected and repaired by a qualified service technician as soon as possible.

STORING A PROPANE-EQUIPPED COACH

Keep the tank valve closed and all of the appliances turned off when the unit is stored. If any of the Propane gas valves do not close leak-tight by hand, consult a service technician.

On older coaches, an LP switch may be located in the front overhead or toward the bottom of the passenger chair. This switch shuts off power to the propane detector to prevent an unnecessary draw from the battery bank while the coach is in storage.

Newer coaches are wired to the disconnect side of the battery disconnect solenoid to prevent the detector from draining the battery while the coach is in storage with the disconnect turned off. Keep this switch turned on when the coach is in use for the capability of detecting a leak in the propane system.

⚠ CAUTION

Shut off the main gas valve at the tank when the vehicle is not in use.

SERVICING THE GAS DISTRIBUTION LINES

The primary gas supply manifold is a black steel pipe running the length of the unit. Most secondary lines leading to the gas appliances are made of copper tubing with flare fittings.

⚠ WARNING

If any of these lines rupture, do not attempt to splice them. Always run a new line. Gas distribution work must be performed by an authorized service technician.

RV Safe 12 Volt Propane Leak Detector Operation (Model: RVLP-2B)

This article provides basic operation instructions for a RV Safe 12 Volt Propane Leak Detector (Model: RVLP-2B).

Understanding The Dangers of Propane Gas

Liquidified petroleum (LP) gas is commonly called propane and is used as fuel for heating and cooking appliances, especially for RV's. Propane gas is explosive at the lower-explosive-limit (LEL), which is 21,000 parts per million (ppm). RV Safe will alarm at 10% LEL, or 2,100 ppm.

Propane gas is denser than air, and will usually accumulate close to the floor. Therefore, RV Safe should be placed near the floor in order to quickly detect propane gas leaks.

Alarm Features and Functions

RV Safe includes an 85dB audible horn, two LEDs, and a Silence/Test button. The chart below summarizes the alarm outputs in each state.

State	Green LED	Red LED	Audible Horn
Normal Operation	ON	OFF	OFF
Power Off	OFF	OFF	OFF
Self Test	OFF	ON/Flashing	4 Chirps constant beeps
Propane Alarm	OFF	ON	Constant beeps
Alarm Silenced (5 Minutes Max.)	OFF	Flash each second	OFF
Low Battery	Flash each minute	Flash each minute	Chirp each minute
End-of-Life or Other Failure	OFF	Double flash each minute	Chirp each minute



NORMAL OPERATION STATE

The green power LED is ON when the alarm is functioning normally and no CO or propane gas is present. Press the Silence/Test button to perform a self test and enter the Test State. Note: Supply current will remain higher for 30 seconds after power-up. Alarm will not detect CO or Propane for the first 30 seconds and will draw extra current.

POWER OFF STATE

If no LEDs are on, then the alarm is powered off. Apply power to the alarm to resume normal operation.

SELF TEST STATE

If the Silence/Test button is pressed while in normal operation, the alarm will perform a self test of the CO sensor, propane sensor and battery voltage. It is recommended to perform a self test weekly, after power up from storage, and before each trip. If the self test passes, the alarm will perform 2 cycles of the CO horn pattern (4 rapid chirps followed by a 4 second pause), followed by 2 cycles of the propane horn pattern (constantly beeping).

PROPANE ALARM STATE

If propane gas exceeds 10% of the lower-explosive-limit for more than 30 seconds, the alarm will enter propane alarm state. The horn will sound with constant beeps and the red LED will be on. Immediately turn off all propane appliances and gas valve at the propane tanks. Open doors and windows to properly ventilate the RV. Check for any gas leaks and contact a qualified RV technician to diagnose possible propane leaks. The alarm may be silence for 5 minutes by pressing the Silence/Test button.

ALARM SILENCE STATE

A CO alarm or propane alarm can be silenced for up to 5 minutes by pressing the Silence/Test button. The red LED will flash each second while the alarm is silenced. The original alarm state will resume after 5 minutes if the CO or propane levels still exceed safe levels.

LOW BATTERY STATE

If the supply voltage drops below 8VDC, the alarm will enter Low Battery State. The horn will chirp every minute and both LEDs will flash every minute. Alarm performance cannot be guaranteed as the supply voltage drops below the low battery threshold. Charge or replace the RV battery immediately. Do NOT disconnect the alarm.

END-OF-LIFE OR OTHER FAILURE STATE

If the CO or propane alarm fails a self test, or if the End-of-Life is reached (after 5 years of operation), the alarm will enter the Failure State. The horn will chirp every minute and both LEDs will do a double flash every minute. Replace the alarm immediately.

Maintaining Your Alarm

- Verify proper alarm function by pressing the Silence/Test button after storage, before every use and once per week during extended use.
- Vacuum the alarm with a soft brush attachment to remove dust monthly.

Source(s): RV Safe Propane Gas Alarm (RVLP-2 and RVLP-3) for RVs Owner's Manual

Product(s): RV Safe Alarm 12V Propane Detector (Model: RVLP-2B, Newmar Part Number: 152865)

Emergency Exits

This article provides step-by-step instructions for opening and closing emergency exit windows and doors.

How to Open and Close the Emergency Exit Windows

This article provides step-by-step instructions for opening and closing emergency exit windows.

Hehr Egress Emergency Exit Window

Select Hehr windows have an opening window pane in the egress window for ventilation. This style of window can also be opened in the event of an emergency.



TO OPEN THE VENT:

1. Unclip and lower the arm.
2. Swing the arm 90 degrees, and push out on the arm until the red handle latches.

TO CLOSE THE VENT:

1. Unclip the red handle from the latch by lifting slightly while pushing outward.
2. Once the latch releases, pull the arm in until the window is closed.
3. Rotate the arm 90 degrees until it latches into the closed position.



IN THE EVENT OF AN EMERGENCY, OPEN THE WINDOW:

1. Remove the screen by pulling out on the red handle.
2. Push and release the lever from the locking hook.
3. Rotate the lever 90 degrees, and push it through the slot in the window frame.
4. Escape through the opening.

Hehr Double-Latched Emergency Exit Window

TO OPEN THE EMERGENCY EXIT DOUBLE LATCH STYLE WINDOW:

1. Flip both latches up to the open position.
2. Push out on the window.



TO CLOSE AND LATCH THE EMERGENCY EXIT DOUBLE LATCH STYLE WINDOW:

1. Pull the window shut while holding the window track with one hand.
2. With the other hand, rotate the latch up until it connects with the track on the window.
3. Press the front side down until it latches.
4. Repeat the steps for the second latch.

How to Operate the Emergency Egress Exit Door and Ladder

This article provides the Newmar-recommended step-by-step instructions for operating the emergency exit door and ladder.

NOTICE

The emergency egress exit door and ladder is a feature only installed on some coach floor plans.

Emergency Egress Exit Door and Ladder

TO USE THE EMERGENCY EGRESS EXIT DOOR:

1. Unlock the deadbolt by turning it in a counterclockwise motion.
2. Make sure the door latch is unlocked.
3. Unlatch and completely open the door to avoid coach damage during ladder extension.



4. Grab and pull the tab to remove the ladder cover, and set it aside.
5. Grab and pull the tab on the Velcro strap to release the ladder.
6. Flip the ladder out, allowing it to extend to the ground.



TO CLOSE THE EMERGENCY EXIT DOOR:

1. Lift the ladder from the bottom, stacking the rungs and pushing the ladder up into the door cavity.
2. Secure it in place with the Velcro strap.
3. Reinstall the ladder cover.
4. Close and latch the door.
5. Lock the door latch by sliding it into the locked position.
6. Lock the deadbolt by turning the deadbolt in a clockwise motion.

This page is intentionally blank.



APPLIANCES

This chapter provides information regarding each appliance available for your coach model and year, including cooktops and ranges, dishwashers, fireplaces, microwaves and convection ovens, refrigerators and freezers, central vacuum systems, and washers and dryers.

IMPORTANT

Any of the following quick start instructions provided by Newmar should not take the place of the manufacturer's complete documentation. Refer to Newgle for more information about appliances offered for your coach's model year.

Before Scheduling Service Work For Your Appliance

IMPORTANT

Most appliance manufacturers (i.e. Whirlpool, GE, Maytag, Samsung, Fisher Paykel) require that any service work performed on their appliances be completed by one of their own authorized service technicians. However, most service technicians will not remove any appliance from its secured location if it is installed inside an RV. Instead, most require the appliance to be removed from its secured location prior to completing any service work.



Complete the following steps prior to scheduling any appliance servicing, repairs, or replacement, as this requires a coordination of multiple parties to complete the repair.

Note: It is recommended that you contact the appliance manufacturer right away so they can note the account. They may also assist with locating an authorized service technician near your location.

In order to service an appliance in your coach, select one of the of the following options:

Option 1

1. Take the coach to your dealer, who can coordinate an appointment with a local manufacturer-specific appliance service technician to come on site to make the repair.
2. In the meantime, one of the dealer technicians will remove the appliance from its mounted position so that the manufacturer-specific technician can service it.
3. Once repairs are complete on the appliance, the dealer technician will reinstall the appliance in its mounted position.

Option 2

1. Set an appointment with a local manufacturer-specific service technician.
2. Contact a local mobile technician to come to your location to remove the appliance prior to the appointment with a manufacturer-specific technician.
3. Once the mobile technician has removed the appliance, the manufacturer-specific technician can then service the appliance.
4. After repairs are made, contact the mobile technician to come back to the coach and reinstall the appliance.

Option 3

1. Set an appointment with a local manufacturer-specific service technician.
2. Remove your own appliance from its mounted position. Some instructions may be found in Newgle or by contacting Newmar Customer Service at 800-731-8300.
3. Once the manufacturer-specific technician has serviced the appliance, reinstall it by reversing the procedure for removing it from its mounted position.



Cooktops and Ranges

Style and function meet for a home cooked meal any night of the week, all at your fingertips. Newmar offers several styles and brands of ranges and cooktops for your coach. Whether a gourmet or beginner chef, your cooktop or range will provide you with all of the necessities - and wants - you desire and deserve to prepare meals for you and your family.

Single or Double Solid Surface Cooktop Cover Overview

This article provides an overview of the solid surface cover for the range or cooktop. This cover may be made up of one or two solid surface pieces.

Your range may be equipped with a solid surface cover that matches your countertop material. This cover helps to protect the burners when they are not in use. Before cooking on the range top, the cover must be removed and stored during cooking.

Some coaches with an induction cooktop may have a solid surface cover with a built-in cutting board.

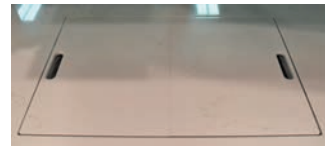

⚠ IMPORTANT

**Never close the cover while the burners are in use.
Never use the range while the RV is moving and remember to reinstall the solid surface cover when the range top is not in use.**

Suburban 3-Burner Propane Elite Series Slide-In Cooktop with Backlighting Operation (Model: 3684A)

This article provides basic operation instructions for a Suburban 3-Burner Propane Elite Series Slide-In Cooktop with Backlighting (Model: 3684A).

Operating Instructions

⚠ WARNING

Do not use surface burners with cover in closed position.

TOP BURNERS

1. Know which knob controls which burner. Always be sure the correct burner is turned on.
2. Depress knob and turn fully counter-clockwise to "Lite" position.
 - Verify sufficient gas supply before attempting to light the burner. Air in the gas line will significantly delay burner ignition. The burner may light unexpectedly as the air in the line clears and is replaced by propane gas. This unexpected ignition could burn you. Air in the gas lines may occur after the vehicle gas bottle and/or tank is refilled, during and after servicing other appliances on same gas line, etc.

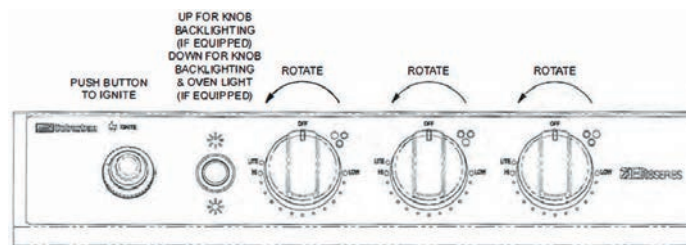

- Do not attempt to light more than one burner at a time.

CAUTION

Hand held ignitors may be used but be sure they are the type designed for lighting open flame burners.

If your model ends with “EC”, the burner can be lit by rotating piezo knob clockwise rapidly. This produces a spark at the burner which ignites the gas. If your model ends with “SC,” the burners can be lit by depressing the button. This produces a spark at the burner which ignites the gas.

3. If any burner should extinguish after initial lighting or due to accidental blow-out, turn gas off by turning control knob clockwise to “OFF”, wait five (5) minutes before attempting to relight the burner. Failure to follow these instructions could result in a fire or explosion.

If the burner should go out while cooking, or if there is an odor of gas, turn control knob(s) clockwise to “OFF.” Wait five (5) minutes for gas odor to disappear. If gas odor is still present - do not relight burners.

4. To turn burner(s) “OFF,” turn the appropriate control knob clockwise to “OFF.”

WARNING

Be sure all control knobs are turned “OFF” when you are not cooking. Someone could be burned or a fire could start if a burner is accidentally left on or unattended even if only momentarily.

OVEN BURNER (IF EQUIPPED)

NOTE: Before the oven burner will operate, the oven pilot must be lit.

1. Lighting Oven Pilot:
 - a. Be sure ALL valves are in the “OFF” position. The oven control knob should be in the “OFF” position.
 - b. Be sure main gas supply is on.
 - c. Open oven door; smell for gas - If you smell gas STOP! Read and follow the instructions on front of your manual.
 - d. If you do not smell gas, turn knob to the pilot position, “Push In/Lite Pilot.”
 - e. If range is equipped with spark ignition, depressing button will provide spark to ignite the pilot.
 - f. Immediately light pilot with a match. Hold knob in at least 5 to 7 seconds for this allows gas to now to pilot and to heat thermocouple. Release knob, pilot should stay on. Note: If the appliance has not been operated for a long period of time, a longer waiting period for ignition of the pilot may be due to air in the pilot and gas lines. If pilot goes out, repeat steps a, b, c, d.

2. Operation of Oven Burner:

- a. Turn the oven control knob counter-clockwise to the desired setting. Oven burner will come on immediately and the oven burner will stay on until it reaches the desired setting. Then the oven burner flame will decrease in size. This is normal for this type of thermostat and this flame size will maintain a constant temperature within the oven.

- NOTE: Oven thermostat was calibrated at the factory and is not field adjustable.

- b. For broiling, a 2-piece porcelain broiler pan can be purchased from Suburban:
 - Center the broiler pan underneath the oven burner flame.
 - Turn the food over frequently to ensure even browning.

3. To Shut Down Oven Burner:

- a. Turn oven control knob clockwise to “Pilot On” position. At this position, the oven pilot will remain lit.

4. To Shut Down Oven Pilot:

- a. Slightly depress knob and turn clockwise to “OFF” position. At this position, the oven pilot will go out.

Light Operation

1. To operate the blue knob backlighting only, press the switch to the up position.
2. To operate the blue knob backlighting and oven cavity light, press the switch to the down position.
3. To turn all lights off, return the switch to the center position.

NOTE FROM NEWMAR

If the burners fail to light due to no spark, unscrew the ignitor cap. Check and replace the battery as needed.



Source(s): Suburban RV Range and Cooktops Installation, Operation, and Maintenance Manual (All SRN/SRS Models)

Product(s): Suburban 3 Burner Stainless Steel Slide-in Cooktop (Model Suburban 3684A 22-in 3-Burner Gas Range with Piezo Ignition (Model: 3684A, Newmar Part Number 153575)

Suburban 3-Burner Propane Elite Series Slide-In Cooktop with Backlighting Operation (Model: 3634A / SCSB2S3Q SX)

This article provides basic operation instructions for a Suburban Elite Series Slide-In Cooktop (Model: 3634A).

Operating Instructions

⚠ WARNING

Do not use surface burners with cover in closed position.

TOP BURNERS

1. Know which knob controls which burner. Always be sure the correct burner is turned on.
2. Depress knob and turn fully counter-clockwise to "Lite" position.
 - Verify sufficient gas supply before attempting to light the burner. Air in the gas line will significantly delay burner ignition. The burner may light unexpectedly as the air in the line clears and is replaced by propane gas. This unexpected ignition could burn you. Air in the gas lines may occur after the vehicle gas bottle and/or tank is refilled, during and after servicing other appliances on same gas line, etc.
 - Do not attempt to light more than one burner at a time.

⚠ CAUTION

Hand held ignitors may be used but be sure they are the type designed for lighting open flame burners.

If your model ends with "EC", the burner can be lit by rotating piezo knob clockwise rapidly. This produces a spark at the burner which ignites the gas. If your model ends with "SC," the burners can be lit by depressing the button. This produces a spark at the burner which ignites the gas.

3. If any burner should extinguish after initial lighting or due to accidental blow-out, turn gas off by turning control knob clockwise to "OFF", wait five (5) minutes before attempting to relight the burner. Failure to follow these instructions could result in a fire or explosion.

If the burner should go out while cooking, or if there is an odor of gas, turn control knob(s) clockwise to "OFF." Wait five (5) minutes for gas odor to disappear. If gas odor is still present - do not relight burners.

4. To turn burner(s) "OFF," turn the appropriate control knob clockwise to "OFF."

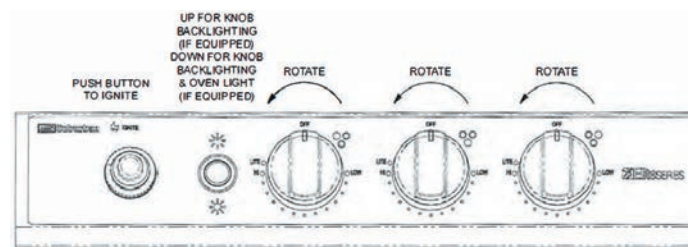

⚠ WARNING

Be sure all control knobs are turned "OFF" when you are not cooking. Someone could be burned or a fire could start if a burner is accidentally left on or unattended even if only momentarily.

OVEN BURNER (IF EQUIPPED)

NOTE: Before the oven burner will operate, the oven pilot must be lit.

1. Lighting Oven Pilot:
 - a. Be sure ALL valves are in the "OFF" position. The oven control knob should be in the "OFF" position.
 - b. Be sure main gas supply is on.
 - c. Open oven door; smell for gas - If you smell gas STOP! Read and follow the instructions on front of your manual.
 - d. If you do not smell gas, turn knob to the pilot position, "Push In/Lite Pilot."
 - e. If range is equipped with spark ignition, depressing button will provide spark to ignite the pilot.
 - f. Immediately light pilot with a match. Hold knob in at least 5 to 7 seconds for this allows gas to now to pilot and to heat thermocouple. Release knob, pilot should stay on. Note: If the appliance has not been operated for a long period of time, a longer waiting period for ignition of the pilot may be due to air in the pilot and gas lines. If pilot goes out, repeat steps a, b, c, d.

2. Operation of Oven Burner:

- a. Turn the oven control knob counter-clockwise to the desired setting. Oven burner will come on immediately and the oven burner will stay on until it reaches the desired setting. Then the oven burner flame will decrease in size. This is normal for this type of thermostat and this flame size will maintain a constant temperature within the oven.
 - NOTE: Oven thermostat was calibrated at the factory and is not field adjustable.
- b. For broiling, a 2-piece porcelain broiler pan can be purchased from Suburban:
 - Center the broiler pan underneath the oven burner flame.
 - Turn the food over frequently to ensure even browning.

3. To Shut Down Oven Burner:

- a. Turn oven control knob clockwise to “Pilot On” position. At this position, the oven pilot will remain lit.

4. To Shut Down Oven Pilot:

- a. Slightly depress knob and turn clockwise to “OFF” position. At this position, the oven pilot will go out.

Light Operation

1. To operate the blue knob backlighting only, press the switch to the up position.
2. To operate the blue knob backlighting and oven cavity light, press the switch to the down position.
3. To turn all lights off, return the switch to the center position.

NOTE FROM NEWMAR

If the burners fail to light due to no spark, unscrew the ignitor cap. Check and replace the battery as needed.



Source(s): Suburban RV Range and Cooktops Installation, Operation, and Maintenance Manual (All SRN/SRS Models)

Product(s): Suburban 3 Burner Stainless Steel Slide-in Cooktop (Model: 3634A, Newmar Part Number: 151387)



Fireplaces

The fireplace provides instant comfort and ambiance to your home away from home. Your fireplace is a 120 volt electric plug-in fireplace, complete with a thermostat-controlled, fan-forced heater. The fireplace may be operated using the flame-only function with realistic flames, or turn on or off the heat function, providing you with flames and heat. Some models have an adjustable interior light, flame speed control, and/or a timer setting, and some can even be operated using a remote control.

Greystone 26” Flat Electric Fireplace Operation (Model: F2655BCFW)

This article provides basic operation instructions for a Greystone 26” Flat Electric Fireplace (Model: F2655BCFW).

Operating Instructions

Ensure that all controls are in the “OFF” position before plugging the appliance in to a properly grounded electrical outlet.

Control Panel

Flame and heater can be presenting separately or at the same time. The fireplace control functions can be access in two ways:

1. Using the touch pad control panel, located on the upper right hand of the fireplace.
2. Using the multi-function remote control functions (same as control panel).

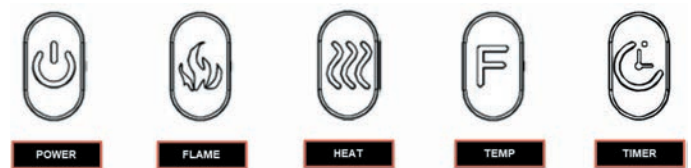

POWER BUTTON

Press the POWER button to turn on the unit. Press again to turn off the unit. As long as the unit is powered on, the log-set will be alight and all functions are access able.

FLAME BUTTON

Flame button controls the brightness of flame effect from the highest to lowest setting. There are five levels of the flame brightness.

- To change the flame color on manual button, hold down the flame button for 3 seconds. The coal bed flame will change from Yellow to Red.
- Hold down the flame button for 3 seconds again. The flame will change from Red to Blue.
- Hold down the flame button for 3 seconds again. The flame will change from Blue to Yellow and Blue.
- Hold down the flame button for a third time for 3 seconds. The flame color will come back to Yellow.

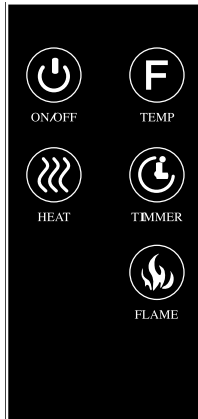

REPLACING REMOTE CONTROL BATTERY

If the remote control stops functioning or operates poorly, the battery should be replaced with a new one (Mode # CR2025).

1. The battery compartment can be found on the back side of the remote control.
2. Press and slide the battery door to open and remove the old battery.
3. Insert a new CR2025 coin battery, making sure that the polarity “+” and “-” matches properly.
4. Close the battery door.

⚠ WARNING

Like any remote control unit, the remote control unit included with your fireplace may unwantedly affect or control other electric products such as TVs. If this occurs, refer to the complete fireplace owner’s manual in Newgle for complete troubleshooting information.

HEATER BUTTON

Press once to activate the low heat setting. Press the button a second time to activate the high heat setting. And a third time to activate the “Auto” function.

TEMP BUTTON

The highest temperature of thermostat is 82°F and the lowest is 62°F. Once the heater is activated, the display screen will display the heater setting in use.

TIMER BUTTON

Press once to activate the TIMER. Use the timer to have the unit turn off automatically after 1 hour, up to 8 hours. The display screen will display the setting shortly.

Zero Clearance Safety Technology

The electric fireplace has zero clearance safety technology. With the advanced zero clearance safety sensor, if there is something covering or closing the slide outs, after about 20 seconds, the appliance will switch off power automatically. Then pull the plug out and let the appliance cool down for three minutes. Plug the power cord in again and the fireplace will begin working again.

Maintenance

⚠ WARNING

Before attempting to perform any maintenance on this appliance, turn all controls to the “OFF” position and unplug. Allow the appliance to be “OFF” for at least 10 minutes before performing any maintenance in order to allow all components to cool properly.

CLEANING

- To remove dust from glass window, use clean dry cloth.
- To remove fingerprints or other marks from glass window, use clean damp cloth. Do not spray glass cleaner or other liquids directly onto the window.
- Clean metal surfaces with a clean damp cloth making sure not to push dust or debris into any air intake or exhaust vents.
- Do not use abrasive cleaners or spray liquids on any part of the appliance.
- Periodic cleaning/vacuuming of the fan/heater unit is strongly recommended to ensure that no dirt or foreign objects build up.

*Source(s): F2655BCFW Greystone Operating and Troubleshooting Guide
Product(s): Greystone 26” Flat Electric Fireplace (Model: F2655BCFW, Newmar Part Number: 154052)*



Microwaves and Convection Ovens

A modern convenience to keep up with even your busiest of travel days. Newmar offers a variety of microwave and convection oven choices to meet your needs and wants to make cooking quick and convenient.

With multiple cooking functions, your microwave allows you to do much more than just warming up last night's leftovers. With the use of a combination of lights, microwaves, and convection heat, preparing entire meals is possible in a fraction of the time it takes in a conventional oven.

All microwaves and convection ovens operate on 120 Volt electricity. The control panel is a touch pad, so entering the temperature, mode, and cooking time desired is simple. A range hood may be incorporated into the microwave. The microwave's control panel also operates the range hood functions, including the fan and light. The fan has two speeds: low and high.

Whirlpool Over-the-Range Microwave Operation (Models: YWMH31017FS, WMH31017HS, YWMH31017HB)

Provides basic operation instructions for a Whirlpool Over-the-Range Microwave (Models: YWMH31017FS, YWMH31017HB, WMH31017HS).

Control Panel

CLOCK

The Clock is a 12-hour (12:00-11:59) clock. Touch CLOCK, enter time, then touch CLOCK or the Start control.

TIMER

With the microwave oven in standby mode, touch the Timer control, enter time, then touch the Timer control or the Start control. Cook functions may be entered while the Timer is counting down. To cancel timer, touch Timer control while the Timer countdown is active in the display.

CONTROL LOCK

Activate to avoid unintended start. Touch and hold the Cancel control for about 3 seconds until 2 tones sound and padlock icon appears in the display. Repeat to unlock control.

VENT FAN

High ("SPd2"), low ("SPd1") and off. Comes on automatically as cooling fan during any cook function.

VENT TIMER (ON SOME MODELS):

Set vent fan to run for exactly 30 minutes, or to run for only 30 minutes more (off after 30 minutes). The vent fan may be turned off at any time using the Vent Fan control. Touch and hold number pad "4" for about 3 seconds until a tone sounds and the vent fan turns on.

TONES

Programming tones and signals. Programming tones may be turned off, or all tones (including end-of-function signals) may be turned off. To turn off programming tones, touch and hold number pad "1" for about 3 seconds, until a confirmation tone sounds. Repeat to turn back on programming tones. To turn off all tones, touch and hold number pad "2" for about 3 seconds until a confirmation tone sounds. Repeat to turn back on all tones.



DEMO MODE

Activate to practice using the control without actually turning on the magnetron. Touch and hold number pad "3" for about 3 seconds until a confirmation tone sounds, and "DEMO" icon lights up in the display. Repeat to deactivate. In Demo mode, the display and controls will work; however, the microwave will not heat.

STANDBY MODE

When no functions are working, oven will switch to standby power mode and dim the brightness after 5 minutes. Press any button or open/close the door and the display will return to the normal brightness.

TURNTABLE

For best cooking results, do not operate the microwave oven without having the turntable in place.

Settings and Features

MANUAL COOKING/STAGE COOKING

Touch COOK TIME, touch number pads to enter time, touch COOK POWER (if not 100%), touch number pads to enter power level (10-90), and then touch the Start control. If programming additional stages, enter the cook time and cook power of each before touching the Start control.

PRESET COOKING

Touch COOK, enter number code of food item, enter quantity, and then touch the Start control.

PRESET REHEATING

Touch REHEAT, enter number code of food item, enter quantity if needed, then touch the Start control.

PRESET DEFROSTING

Unwrap food. Touch DEFROST, enter number code of food item, enter weight, then touch the Start control.

SOFTEN/MELT

Touch SOFTEN/MELT, enter number code of food item, enter quantity, then touch the START control.

POPCORN

Touch POPCORN. Enter bag size in ounces: 3.0 or 3.5 (85 or 99 g), then touch START control.

(BAKED) POTATO

Touch (BAKED) POTATO. Enter number of potatoes: 1, 2, 3 or 4, about 10 to 13 oz (283 to 367 g) each, then touch START control. NOTE: Place fork-pierced potatoes around turntable edges, at least 1" (2.5 cm) apart. Place a single potato to the side of the turntable (not in the center).

PIZZA (REHEAT)

Touch PIZZA. Enter number of slices: 1, 2 or 3, about 4 oz (113 g) each, then touch START control.

Source(s): Whirlpool Microwave WMH31017 User Guide

Product(s): This source is associated with more than one product. Refer to Newgle for more information about the product(s) offered for your coach's model year.

Whirlpool Convection Smart Microwave Operation (Models: WMH78019HZ and WMH78019HB)

This article provides basic operation instructions for a Whirlpool Convection Smart Microwave (Models: WMH78019HZ and WMH78019HB).

Control Panel

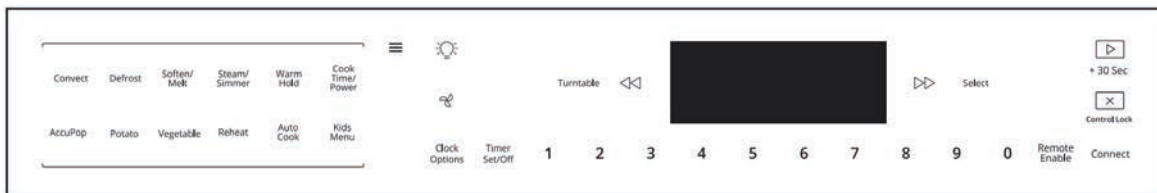

CLOCK/OPTIONS

SET THE CLOCK

1. To set the clock, for example, to 2:25 PM, touch the Menu keypad.
2. Touch CLOCK/OPTIONS.
3. Use the number keypads to enter "2:25."
4. Touch SELECT.
5. Touch "2" to display PM.

REACH OPTIONS MENU

1. Touch CLOCK/OPTIONS.
2. Use the arrow keypads to scroll through options.
3. Touch SELECT to select desired option and follow the prompts.

LIGHT: TURN ON LIGHT

1. Press the Light keypad to turn the light beneath the hood on or off.

TIMER (SET/OFF): KITCHEN TIMER

1. Touch TIMER SET/OFF.
2. Touch the number keypads to set the length of time. For example, to set 12 minutes length time, touch TIME SET/OFF.
3. Use the number keypads to enter "12:00."
4. Touch START.
5. If the Cancel keypad is touched, the microwave oven will turn off; however, the Timer can only be turned off using the Timer Set/Off keypad.

START/ADD 30 SEC

Touching the Start/Add 30 Sec keypad when the microwave oven is off will start 30 seconds of cook time at 100% power. If cooking is interrupted by opening the door, touching Start/Add 30 Sec after the door is closed again will resume the preset cycle.

NOTE FROM NEWMAR
The **START** button displays like a **PLAY** button. It functions as both the **START** and the **(+30 Sec) ADD 30 SECONDS** function.

CANCEL

CANCEL COOKING FUNCTION

Touch the Cancel keypad to cancel cooking function. The Cancel keypad stops any microwave oven function except for the Clock, Timer, and Control Lock.

The microwave oven will also turn off when the door is opened. When the door is opened, the element(s) and fan will turn off, but the microwave oven light will remain on. Close the door and touch the Start keypad to resume the preset cycle.

The microwave oven cooling fan may continue to operate even after a microwave oven function has been canceled or completed, depending on the microwave oven temperature.

ACTIVATE CONTROL LOCK

Activate to avoid unintended start. Touch and hold the Cancel keypad for about 3 seconds until two tones sound and the Padlock icon appears in the display. Repeat to unlock control.



FAN: TURN ON FAN

1. Press the Fan keypad to turn the Fan on or off. Press the fan keypad repeatedly to change from low to high.



LEFT AND RIGHT ARROWS: NAVIGATE MENU

Press the Left or Right Arrow keypad to move through the menu.



SELECT: OPTIONS

Touch SELECT to select options.



TURNTABLE: ON/OFF

By touching the Turntable On/Off keypad, it is possible to switch the turntable on and off during some microwave cycles. The turntable can be turned on or off only during Manual cooking cycles.



REMOTE ENABLE: ENABLE REMOTE APP CONTROL

Remote Enable allows you to start Convection Bake cooking cycle using your mobile phone when you are away from home. Press REMOTE ENABLE to enable the ability to utilize the Whirlpool® app.



CONNECT: WI-FI

Press and hold CONNECT while your router's WPS indicator light is blinking to connect your range to your Wi-Fi network.



Refrigerators, Freezers and Ice Makers

Offering all of the ingredients you need for a satisfying life on the road. Newmar offers many quality options for your food storage needs, all while blending beautifully with your sleek decor. With adjustable and removable shelving, your refrigerator and freezer provides you with the flexibility you need to fit your on-the-road lifestyle. Many models offer the convenience of electronic controls, a built in icemaker, and a filtered water dispenser.

Absorption-Style Refrigerators

This article provides basic operating instructions for an absorption-style refrigerator.

Absorption-style refrigerators are installed on select coaches. The control panel operates via 12 volts supplied by the battery/batteries. The refrigerator operates on 120 volt AC power or LP gas and heats a solution in a closed loop system. As the solution changes state and passes through the absorption stage, it cools the inside of the refrigerator and freezer box by extracting the heat and carrying it away in the solution. It does not use freon and a compressor, so this style of refrigerator takes longer to cool down.

Cooking Options and Additional Features



MENU: TURN ON BACKLIT BUTTONS

1. Press the Menu keypad to light up the back-lit buttons.
 - Convection: Auto Convection Cooking, Manual Convection Bake, Manual Convection Roast
 - Defrost: Automatic Defrost
 - Soften/Melt: Soften, Melt
 - Steam/Simmer: Auto Steam Cook, Manual Steam Cook, Auto Simmer Cook, Manual Simmer Cook
 - Warm Hold: Keep Food Warm
 - Cook Time/Power: Manual Cooking
 - AccuPop: Popcorn (Sensor)
 - Potato: Potato (Sensor)
 - Vegetable: Vegetable
 - Reheat: Automatic Reheat
 - Auto Cook: Auto Cook
 - Kids Menu: Kids Menu

For more information about the cooking options and additional features, refer to the “Whirlpool Convection Smart Microwave (WMH78019HZ) User Instruction Manual.”

Source(s): Whirlpool Convection Smart Microwave (WMH78019HZ) User Instructions

Product(s): Whirlpool 30" 1.9 Cu Ft 1100w Convection Smart Microwave (Model: WMH78019HZ, Newmar Part Number: 140692) and Whirlpool 30" 19 Cu Ft 1100w Black Convection Microwave (Model: WMH78019HB, Newmar Part Number: 143251)

2. The refrigerator is equipped with a energy control system. It can be set to either 120 Volt or propane gas operation, or set automatically select 120 volts when present and automatically change to gas when AC power is not present, if desired.
3. Verify 12 volt supply for control board operation.
4. It is recommended to pre-chill food and beverages before putting them in the refrigerator and freezer. When placing items on the racks and in the bins, leave enough space for air to flow throughout the entire refrigerator cabinet.
5. For models with a built-in ice maker, a pressurized water supply is required. In order for the ice maker to operate, you must have water in the fresh tank and have the water pump turned on, or your coach must be connected to city water supply.

How To Operate The Refrigerator In 120 Volt Mode

1. A 12 volt power supply must be available for the electronic control panel to function. The shore line must be plugged in, or the generator running, to operate in 120 volt mode.
2. To use the 2-Way Auto Mode, push the AUTO/GAS mode selector into the ON position. If 120 volt is available, the AC mode indicator light will be illuminated.

How To Operate The Refrigerator In Propane Gas Mode

1. The main propane gas valve must be open for operation in the propane mode.
2. To start the refrigerator, press the main power ON/OFF button to switch it to the ON position.
3. If 120 volt is not available, the gas mode indicator light will be illuminated. The control system will automatically switch to gas operation.
4. To operate on gas only, push the AUTO/GAS mode selector until the gas indicator light has lit. After 45 seconds the burner should be ignited and operating normally. The initial startup may take longer than 45 seconds in order to allow the air to be purged from the gas line.

For more information about the operation of the refrigerator installed in your coach see the following information that matching the manufacture and model series of your particular refrigerator.

WARNING

Most propane gas appliances used in recreational vehicles are vented to the outside of the vehicle. When parked close to a gasoline pump, it is possible that the gasoline fumes could enter this type of appliance and ignite the burner flame causing a fire or explosion. Use caution when refueling.

WARNING

Do not bring or store propane cylinders, gasoline, or other flammable liquids inside of the vehicle. Failure to comply could result in fire or explosion.

DANGER

All pilot lights, appliances, and their igniters (see operating instructions) shall be turned off before refueling of motor fuel tanks and/or propane containers.

Can cause ignition of flammable vapors, which can lead to a fire or explosion and result in death or serious injury.

DANGER

Éteindre les veilleuses, les appareils et leur dispositif d'allumage (voir les instructions d'utilisation) avant le remplissage des réservoirs de carburant et (ou) des bouteilles de propane.

L'avitaillement de carburant peut causer l'inflammation spontanée de vapeurs inflammables, ce qui peut causer un incendie ou une explosion et entraîner des blessures graves ou la mort.

AD-05F

Norcold Four Door Refrigerator with Built-In Ice Maker Operation (Model: 1200 and 1210 Series)

Provides basic operation instructions for a Norcold Four Door Refrigerator with Built-In Ice Maker (Model: 1200 and 1210 Series).

AC Operation

- 120 volts AC: 108 volts min.-132 volts max.
- 12 volts DC - control voltage: 10.5 volts min. - 15.4 volts max.

The refrigerator operates on these energy sources. Operation out of these limits can damage the refrigerator electrical components and will void the warranty.

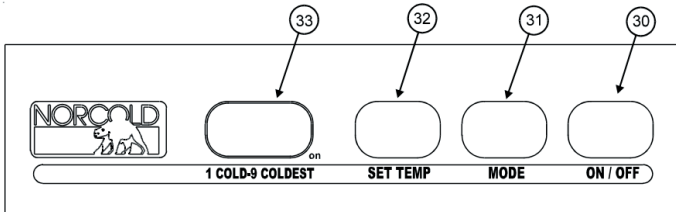

Control Panel

The refrigerator control panel is between the freezer compartment and the fresh food compartment.

To maintain the operating control functions of the refrigerator, a 12 volt DC power supply is necessary. The refrigerator receives DC power from the 12 volt system of the vehicle; either an auxiliary battery, a converter, or the vehicle engine battery.

ON/OFF BUTTON

The ON / OFF button [30] starts and shuts down the refrigerator:

1. To turn on the refrigerator, push and release the ON / OFF button.
2. To turn off the refrigerator, push the ON / OFF button for one second and then release.

SET TEMP BUTTON

The SET TEMP button [32] controls the temperature adjustment of the freezer and the fresh food compartment.

1. Push the SET TEMP button and the temperature setting (the numbers "1-9") show in the center display [33]. The number "9" is the coldest temperature setting.
2. Push and hold the SET TEMP button and the temperature setting changes.
3. Release the SET TEMP button when the temperature setting that you wish appears.
4. After ten seconds, the temperature setting will go out and only a green power ON light remains.

NOTE: Push and release the MODE button to show "AC", the current mode of operation, in the center display for 10 seconds.

5. If 120 volts AC is not available to the refrigerator:
 - The fault codes "no" "AC" shows in the center display and an audible alarm sounds.
6. If 120 volts AC is available to the refrigerator, but is not operating correctly:
 - A fault code shows in the center display, and an audible alarm starts.

Optional Ice Maker

The ice maker is fully automatic and will operate in ambient temperatures as low as 0° F. To allow operation at temperatures between 0° F and 32° F., the ice maker has a heater on the solenoid water valve and on the water line between the solenoid valve and the ice maker.

When the freezer temperature of the refrigerator is low enough, the ice maker opens the water solenoid valve and fills the mold. The ice maker ejects the frozen ice into a storage bin. As the storage bin fills, the ice raises the shut-off arm until it turns off the ice maker. As you use the ice and lower the ice level in the storage bin, the shut-off arm also lowers. This turns the ice maker ON and begins the process of making ice.

The ice maker operates on:

- Cold potable water at a pressure of 15 psi - 125 psi
- 120 Volts AC: 108 VAC min. - 132 VAC max.

ICE MAKER OPERATION:

1. Make sure the ice maker AC power cord is plugged into a receptacle.
2. Open the water shut off valve of the vehicle.

NOTE: Make sure that the ice maker arm can move freely and does not touch the frozen foods in the freezer.

3. Push the ice maker arm down to the ON position.

CAUTION: If you operate the refrigerator without the proper water supply, make sure the ice maker arm is up in the OFF position.

4. Allow the freezer to cool enough and ice production will begin to fill the storage bin.

NOTE: New plumbing connections and/or impurities in the water supply line after winterizing can cause the first ice to be discolored or have an odd flavor.

5. To stop the ice maker, push the ice maker arm up to the OFF position.

Source(s): Norcold Owner's Manual for 1200ACXX Models

Product(s): Norcold 12 Cu Ft 4 Door Refrigerator w/Ice Maker and Water Dispenser (Model: 1200IM, Newmar Part Number: 96051)

Norcold Refrigerator Operation (Model: N10 Series)

This article provides basic operation instructions for a Norcold Refrigerator with Ice Maker (Model: N10 Series).

Operating The Controls

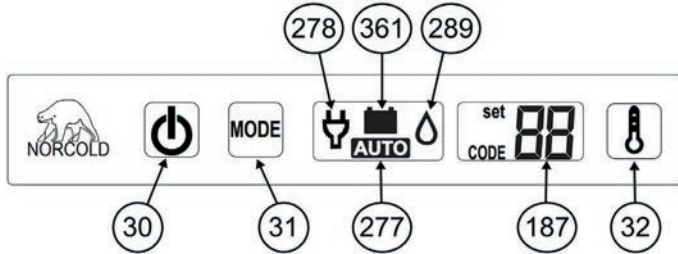

IGNITION AND START UP

- Make sure the air flow in the lower intake vent, through the refrigerator coils and condenser, and out the upper exhaust vent is not blocked or decreased.
- Make sure there are no combustible materials in or around the refrigerator.
- Make sure the DC voltage to the refrigerator is 12.0VDC

AIR IN THE PROPANE GAS SUPPLY LINES

Notice: For safety reasons, the refrigerators electronic controls are designed such that while operating in the LP GAS mode, the trial for ignition (maximum amount of the time the gas valve and igniter can be left on without a flame present) is limited to 30 seconds. When starting the refrigerator for the first time, after storage, or after replacing the propane gas tank, the propane gas supply lines can have air in them.

Due to air in the gas supply lines, the burner may not ignite within the 30 second time limit. In the event this should happen the gas valve and igniter outputs will be turned off, the LP Gas mode will be “locked out”, and the appropriate fault code will be shown in the display.

The gas lock out condition can be reset by powering the refrigerator OFF and then back ON, at which time, a new 30 second trial for ignition will commence. It may be necessary to repeat this procedure several times before expelling all the air from the LP gas supply line. If after repeated attempts, a flame is not established, stop and consult your local dealer or Authorized Norcold Service Center.

AUTOMATIC MODE OPERATION:

- Touch and release the ON/OFF button [30] to turn the refrigerator on.
- Touch the TEMP SET button [32] as needed to set the temperature setting.
 - Number one (1) shown in the display [187] is the warmest setting.
 - Number nine (9) shown in the display [187] is the coldest setting.

- If the AUTO icon [277] and AC PLUG icon [278] are lit up, it means that:
 - 120 volt AC power is available to the refrigerator.
 - The refrigerator is operating on AC electric power.
 - After ten seconds, the backlight of the display goes off.
- If the AUTO icon and the FLAME icon [289] are lit up, it means that:
 - 120 volt AC power is not available to the refrigerator.
 - The refrigerator is operating on propane gas.
 - After ten seconds, the backlight of the display goes off.

IF NEITHER 120 VOLTS AC NOR PROPANE GAS ARE AVAILABLE TO THE REFRIGERATOR :

- 2-way refrigerators:
 - The fault codes “no AC” and then “no FL” show in the display and an audible alarm sounds.
 - Refer to the “Fault Codes” section of the refrigerator’s manual for any faults displayed.
- 3-way refrigerators only:
 - The Auto icon and the Battery icon [361] are lit up.
 - After ten seconds, the backlight of the display goes off.
 - This means that the refrigerator is operating on DC electric.

IF AN ENERGY SOURCE IS AVAILABLE TO THE REFRIGERATOR BUT IS NOT OPERATING CORRECTLY:

- While operating in the Automatic mode, the refrigerators electronic controls will automatically select the energy source using the following priority scheme:
 - 1st choice: AC Electric
 - 2nd choice: LP GAS
 - When in the Auto mode, if a higher priority choice becomes available (i.e., AC voltage reapplied), the control shall stop using the current mode and switch to the higher priority mode.

MANUAL AC MODE OPERATION

- Touch and release the ON/OFF button [30] to start the refrigerator.
- Touch the MODE button [31] until the AUTO icon goes off and only the AC PLUG icon [278] remains lit.
- Touch the TEMP SET button [32] as needed, to set the temperature setting.
- The AC PLUG icon [278] remains lit until you select a different operating mode or shut down the refrigerator.

MANUAL LP GAS OPERATION

- Touch and release the ON/OFF button [30] to start the refrigerator.
- Touch the MODE button [31] until the AUTO icon goes off and only the FLAME icon [289] remains lit.
- Touch the TEMP SET button [32] as needed, to set the temperature setting.
- The FLAME icon [289] remains lit until you select a different operating mode or shut down the refrigerator.

SHUT DOWN - ALL MODELS:

- To shut down the refrigerator, touch and hold the ON/OFF button [30] for two seconds and release.

Source(s): Norcold Owner's Manual for Polar 10 Series (N10LX and NA10LX models) Refrigerators

Product(s): This source is associated with more than one product. Refer to Newgle for more information about the product(s) offered for your coach's model year.

Residential-Style Refrigerators

This article provides a general overview of how a residential-style refrigerator operates.

Residential-style refrigerators are the most popular option installed in Newmar coaches. The refrigerator operates on 120 volt AC power and uses freon and a compressor to keep your food cold and fresh. The power may be supplied by the electrical hookup at the campsite, generator power or (in most coaches) an inverter with a charged house battery bank.

For models with a built-in ice maker, a pressurized water supply is required. In order for the ice maker to operate, you must have water in the fresh tank and have the water pump turned on, or your coach must be connected to city water supply.

When placing items on the racks and in the bins, leave enough space for air to flow throughout the entire refrigerator cabinet.

All models are equipped with a means to latch and secure the doors for a tight seal and to prevent the doors from opening during transit. Become familiar with the latch operation and always lock prior to traveling.

Whirlpool Residential Refrigerator with Top Freezer Operation (Model: WRT112CZJZ)

This article provides basic operation instructions for a Whirlpool Residential Refrigerator with Top Freezer (Model: WRT112CZJZ).

Operating The Refrigerator

TEMPERATURE CONTROL

Temperature Control For your convenience, the temperature control is preset at the factory. When you first install your refrigerator, make sure the control is still preset as shown.

- Note: Neither compartment will cool when the control is set to OFF.

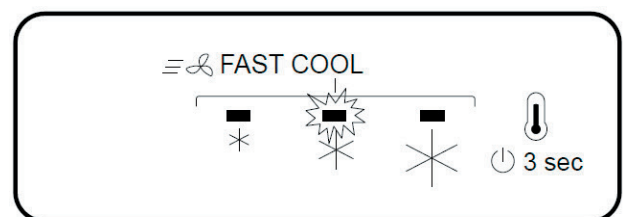

Recommended Setting

ADJUSTING THE TEMPERATURE CONTROL

If you need to adjust the temperature on either the refrigerator or freezer compartment, use the settings listed in the chart below as a guide.

Note: Except when starting the refrigerator, do not adjust the control more than one setting at a time. Wait 24 hours between adjustments for the temperature to stabilize.

- Press the Temp button to toggle among the third LED lights which indicate the temperature setting. Reading from left to right, the LED in the first position is the least cold. The LEDs indicate increasingly colder settings as you continue to the right until all third LEDs are illuminated.

Condition/Reason	Adjustment
Refrigerator too warm	Temperature Control one setting higher
Freezer too warm/too little ice	Temperature Control one setting higher
Refrigerator too cold	Temperature Control one setting lower
Freezer too cold	Temperature Control one setting lower

AIRFLOW CONTROL

The Airflow control is located on the back wall of the freezer. It regulates the amount of air flowing between the freezer and the refrigerator compartments. When you plug in the refrigerator for the first time, turn the Airflow control to the Recommended setting.

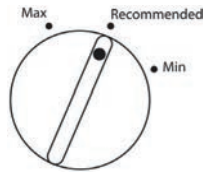

ADJUST THE AIRFLOW CONTROL

If you want to temporarily increase the cold airflow to a specific compartment, adjust the control.

NOTE FROM NEWMAR	
Once the performance is achieved, return the Airflow control to the Recommended setting to keep the refrigerator operating at optimum efficiency.	
Condition/Reason	Adjustment
Heavy ice use	Max
Hot room temperature	Max - To maintain ice making production rate
Large quantity of groceries	Min - To quickly chill food and beverages

CRISPER HUMIDITY CONTROL (ON SOME MODELS)

You control the amount of humidity in the moisture-sealed crisper. Depending on the produce you are storing, select the desired Humidity Level.

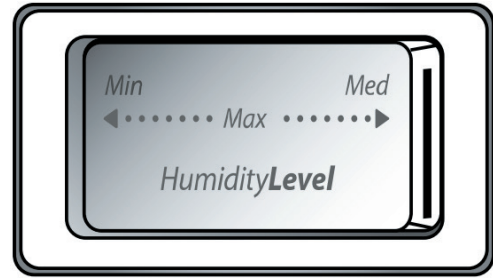

HUMIDITY LEVEL - MIN SETTING

MIN (open) lets moist air out of the crisper for best storage of fruits and vegetables with skins.

- Fruit: Wash, let dry and store in refrigerator in plastic bag or crisper. Do not wash or cut berries until they are ready to use. Sort and keep berries in original container in crisper, or store in a loosely closed paper bag on a refrigerator shelf.
- Vegetables with skins: Place in plastic bag or plastic container and store in crisper.

HUMIDITY LEVEL - MAX SETTING

MAX (closed) keeps moist air in the crisper for best storage of fresh, leafy vegetables.

- Leafy vegetables: Wash in cold water, drain and trim or tear off bruised and discolored areas. Place in plastic bag or plastic container and store in crisper.

Source(s): Whirlpool User Guide Top Mount Refrigerator (W11331641B)

Product(s): This source is associated with more than one product. Refer to Newgle for more information about the product(s) offered for your coach's model year.



Washer and Dryer Overview

Depending on your model, year, and available options, your coach may be equipped with a stackable washer and dryer, or an all-in-one laundry center located in a cabinet. They are built for life on the road, so they are compact to save space, weight, and resources, without sacrificing performance. Some coach floorplans may also provide the option for washer and dryer hookups, in lieu of the appliances.

Operation

The plumbing and other preparations for the installation of a compact washer and dryer are optional features on your coach. The washers and dryers function like those in a home. Most operate on 120 volt electricity; however, some dryers may require 240 volt electricity.

Washer and Dryer Prep

If a washer and dryer unit is not installed in your coach, it may be prepped at the factory so that a unit can be added later. Units not ordered and/or installed by the factory will not be covered by Newmar's warranty.

P-Traps

Each of the sink drains, the shower drain, and the washing machine drain (if equipped) has a water trap to prevent holding tank odors from entering the coach. These traps must have water in them in order to trap the odors. While stored, the water may evaporate, allowing an odor to enter the coach. If this occurs, run water from the faucet into the drain, allowing water to fill the trap. Run water into the washing machine. Set the cycle to spin to drain the water to fill the p-trap.



WARNING

Do not operate the dryer without opening a window or outside vent to provide outside air. Failure to comply may cause asphyxiation which could result in death or serious injury.

CS-91

NOTICE

Remove outside drain cap before operating washing machine.

NI-12

IMPORTANT

The gray tank valve must be in the 'open' position when operating the washing machine.

Splendide Front-Loading Washer Operation (Model: WFL1300XD)

This article provides basic operation instructions for a Splendide Front-Loading Washer (Model: WFL1300XD).

Control Panel

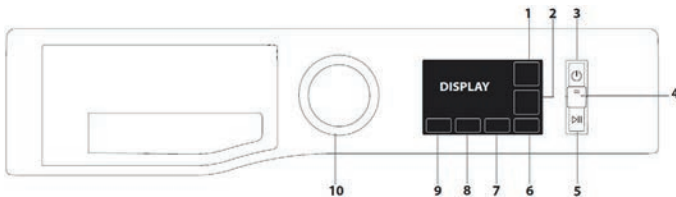

1. SUPER WASH / MUTE button
2. POST CYCLE CARE / KEY LOCK button
3. ON/OFF button
4. PREWASH button and indicator light
5. START/PAUSE button
6. EXTRA RINSE button
7. DELAY START button
8. SPIN button
9. TEMPERATURE button
10. WASH CYCLE SELECTOR KNOB

Detergent Dispenser Drawer

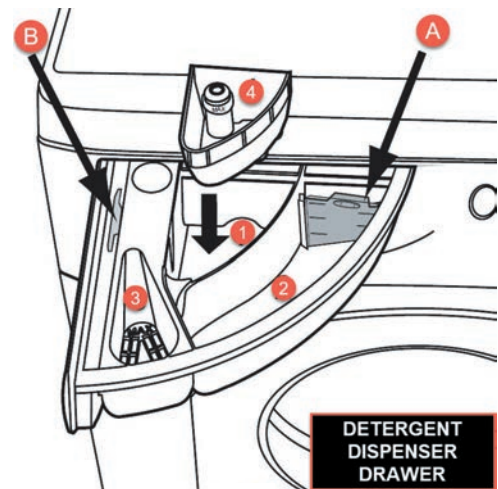

Compartment 1: Pre-wash detergent (powder)

Compartment 2: Detergent for the wash cycle (powder or liquid)

- If liquid detergent is used, it is recommended that the removable plastic partition A (supplied) be used for proper dosage.
- If powder detergent is used, place the partition into slot B.

Compartment 3: Additives (fabric softeners, etc.)

- The fabric softener should not overflow the grid.

Extra Compartment 4: Bleach

Note: Splendide recommends using 1 to 2 tbsp. of a bio-friendly fabric softener, or similar brand per wash load. These softeners tend to appear light in color and dissolve more quickly in less water, minimizing build-up within your machine.

Note: Use powder detergent for white cotton garments, for pre-washing, and for washing with hot temperatures.

Note: Follow the instructions given on the detergent packaging.

Display

The display is useful when programming the washing machine and provides plenty of information.

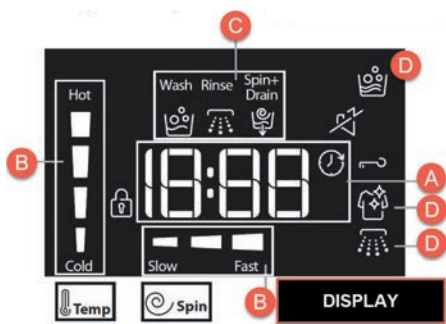

SECTION A

The duration of the available wash cycles and the remaining time of a running cycle appear in section A (Factors such as load size, modifiers, options selected, and water pressure may affect the time shown in the display. Tightly packed loads, unbalanced loads, or excessive suds may cause the washer to lengthen the cycle time as well); if the DELAYED START option has been set, the countdown to the start of the selected wash cycle will appear.

SECTION B

In section B, pressing the corresponding button allows you to view the maximum spin speed and temperature values attained by the machine during the set wash cycle, or the values selected most recently, if these are compatible with the set wash cycle.

SECTION C

The “wash cycle phases” corresponding to the selected wash cycle and the “wash cycle phase” of the running wash cycle appear in section C: Wash, Rinse, Spin + Drain.

SECTION D

References D indicate the wash options available. For a list of these options, refer to Splendide’s Instruction Manual.

DELAY START

The “Delay Start” symbol [clock icon], when lit, indicates that the set “delayed start” value has appeared on the display.

MUTE

The “Mute” symbol [speaker icon] indicates the possibility to silence the key tones. While the mute is active, almost all sounds will be turned off. Only the sound signals and the alarms remain active, as well as the sound of the end of cycle. To activate/deactivate, press and hold the mute button.

KEY LOCK

To lock the control panel, press and hold the “Key lock” button for approximately 3 seconds. The symbol will light up on the display to indicate that the control panel has been locked (with the exception of the “ON/OFF” button). This prevents unintentional changes to programs, especially with children near the machine. To unlock the control panel, press and hold the “Key lock” button for approximately 3 seconds.

LOCKED DOOR INDICATOR

When lit, the symbol indicates that the door is locked. To prevent any damage, wait until the symbol turns off before opening the door. To open the door while a cycle is in progress, press the START/PAUSE button; if the LOCK symbol is off, the door can be opened.

First Time Use

Once the appliance has been installed, and before it is used for the first time, run a “Clean Washer” cycle with liquid chlorine bleach and no laundry.

Daily Use

- Press the ON/OFF button.
- Open the door. Load the laundry while making sure not to exceed the maximum load quantity indicated in the wash cycle table.
- Pull out the detergent dispenser drawer and pour the detergent into the relevant compartments, as described in the “DETERGENT DISPENSER DRAWER” section. - Close the door.
- The machine automatically displays the default temperature and spin speed values for the selected cycle, or the most recently used settings for that specific cycle.
- Select the desired wash cycle.
- Select the desired options.
- Press and hold the START/PAUSE button to start the wash.

IMPORTANT

For more information about wash settings, cleaning and maintenance, and winterization, refer to Splendide’s Instruction Manual.

Source(s): WFL1300XD Splendide Washing Machine Instruction Manual

Product(s): Splendide WFL1300XD 24-in Front-Loading Washer (Model: WFL1300XD, Newmar Part Number: 156340)

Splendide Tumble Dryer Operation (Model: DV6400X)

This article provides basic operation and cleaning instructions for a Splendide Tumble Dryer (Model: DV6400X).

Control Panel

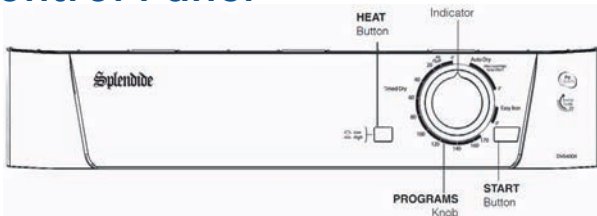

The START button begins drying a selected program (see Start and Programs in the Owner's Manual).

The HEAT button selects drying temperature (see Start and Programs).

IN: HIGH heat.

OUT: LOW heat

The Drying Guide allows you to consult a user friendly table of fabric types and load capacities.

The Special Programs Guide gives a guide to the available programs.

The PROGRAMS knob sets the program: rotate it clockwise, never counter-clockwise, until the indicator is pointing to the program you want to select (see Start and Programs). The programs knob will advance to the '0' position after the program ends.

Cleaning and Maintenance

CLEAN THE FILTER AFTER EACH CYCLE

The filter is an important part of your dryer: it accumulates lint and fluff that is formed while drying. Small items could also become trapped in the filter. When finished drying, therefore, clean the filter by rinsing it under running water or with your vacuum cleaner. Should the filter become clogged up, the airflow inside the dryer will be seriously compromised: drying times lengthen and you will consume more energy. It may also damage your dryer.

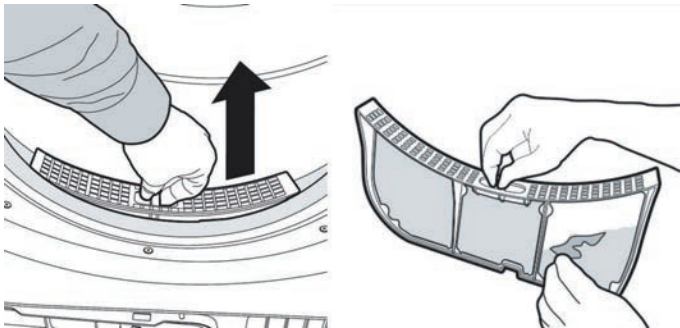

The filter is found in front of the dryer trim (see diagram).

REMOVING THE FILTER:

1. Pull the plastic grip of the filter upwards (see diagram).
2. Clean the filter and replace it correctly. Ensure the filter is fully located flush into the tumble dryer trim.

IMPORTANT

Do not use the dryer without replacing the filter.

IMPORTANT

For more information about dryer settings and available programmed drying cycles, refer to Splendide's Care, Use and Installation Booklet.

CHECK THE DRUM AFTER EACH CYCLE

Turn the drum manually in order to remove small items (handkerchiefs) that could have been left behind.

CLEANING THE DRUM

Do not use abrasives, steel wool or stainless steel cleaning agents to clean the drum.

A color film may start to appear on the stainless steel drum, this may be caused by a combination of water and, or cleaning agents such as fabric conditioner from the wash. This colored film will not affect the dryer performance.

CLEANING THE DRYER

- External parts in metal or plastic and rubber parts can be cleaned with a damp cloth.
- Periodically check the vent tube and any permanent venting fixture to make sure that there has been no accumulation of fluff or lint, and remove it.
- Remove lint that collects around the filter and the outlet vents.

IMPORTANT

Do not use solvents or abrasives. Your dryer uses special bearing components which do not need lubrication. Have your dryer checked regularly by authorized technicians to ensure electrical and mechanical safety.

Source(s): DV6400X Splendide Tumble Dryer Care, Use and Installation Booklet

Product(s): Splendide DV6400X 24-in Dryer (Model: DV6400X, Newmar Part Number: 156341)

This page is intentionally blank.



CHASSIS

This chapter provides information from your chassis manufacturer, detailed operating instructions for the fuel, leveling, and steering systems installed in your coach, as well as guidelines for proper use and maintenance of your wheels and tires.

IMPORTANT

Any of the following quick start instructions provided by Newmar should not take the place of the chassis manufacturer's complete documentation. Refer to your chassis owner's manual for information relating to vehicle identification and safety, dash instruments, controls, and switches, steering and braking systems, driver assistance features, maintenance recommendations, etc.



Ford

The specific information for your chassis is provided by Ford and covers many topics including general maintenance, engine information, capacities, tire information, and driver tips.

This article provides contact information for Ford, including phone, web address, and mailing address.

Roadside Assistance

- Phone: 800.392.3673
- Web: <http://owner.ford.com/contact-us.html>
- Mail: Ford Motor Company | Customer Relationship Center | P.O. Box 6248 | Dearborn, MI 48126

Chassis Manuals

Refer to Ford's Owner's Manuals in Newgle for all chassis-related information, including, but not limited to:

- Vehicle Identification
- Dash Instruments, Controls, and Switches
- Steering and Brake Systems
- Driver-Assistance Features
- Emergency Procedures
- Inspection and Maintenance

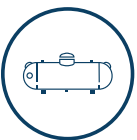

Fuel Systems

This section provides information about the fuel systems in your coach, including LP (if equipped), chassis engine fuel, and auxiliary fuel tanks (if equipped).

Chassis Gas Engine Fuel

This article provides information regarding the chassis gas engine fuel, as well as some labels that may appear on the inside or outside of the coach.

Below are sample labels that might appear on the inside or outside of your coach.

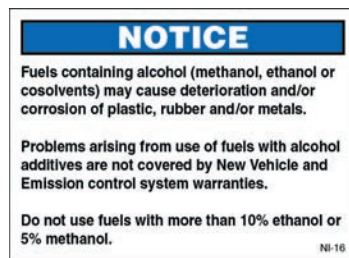



Leveling Systems

This section has information about air, electric, and hydraulic leveling systems. Due to a very wide range of operation procedures, refer to the information under the brand and model that applies to your coach.

⚠ WARNING

Do not lift the wheels off of the ground while leveling the coach. The vehicle may drop and/or move forward or backward without warning, which may cause serious injury or death.

⚠ WARNING

Never attempt to move the unit with the leveling jacks deployed. Always visually inspect the jacks prior to moving to ensure they are fully retracted, are in the stored position, and the system is turned OFF.

Care and Maintenance

⚠ IMPORTANT

The leveling system should be cycled at least once a month to keep the system in operating condition.

⚠ WARNING

Be sure the ground on which you are parked will support the weight of your unit. Often material that seems “safe” to level on will not support the weight at the leveling jack points. Use caution when leveling on hot asphalt, sand, and grass, as the weight of the unit may cause the jacks to sink into the ground. Pads may need to be placed under the jacks to spread the weight over a larger area. Always look under your unit prior to leveling to make sure the jacks are clear of debris and other foreign materials that may interfere with leveling.

⚠ WARNING

Never operate any leveling system with a person or pet under the unit. Serious injury or death may result!

Leveling and Full Wall Slideout Sequence of Operation

This article provides step-by-step instructions for leveling the coach and operating the slideouts.

⚠ IMPORTANT

In the past, Newmar has recommended leveling the coach prior to deploying the slideouts. As of 2015, Newmar makes the following recommendation for the extension and retracting of slideouts.

Motorhomes, like all vehicles, flex in travel. Flexing may be different due to terrain and the coach’s fulcrums (resting on tires or jacks). As the coach flexes, this movement is more noticeable in the outside reveal on a wider slideout.

Extending The Slideouts and Leveling The Coach

1. Park the coach on a reasonably level campsite.
2. Leave the coach at ride-height with air in the air bags (if equipped with air suspension) or on normal suspension (coaches without air suspension).
3. Plug the coach into shore power (if available) or start the generator to increase the voltage for better slideout operation.



4. Look at the “reveal” or “gap” of the two vertical wall trims around the slideouts to make sure there is plenty of clearance so the trim will not rub when extending the slideout. If the gap looks good, then the slideout can be operated.
 - **Note: Most often the gap will look best when sitting on the tires with the air suspension inflated (at ride-height), and not on the jacks.**
5. Verify that the path of the slideout is unobstructed and free from any surrounding objects, both inside and outside of the coach.
6. Once the appropriate conditions are met, follow the operating instructions posted in your coach to extend the slideouts.

⚠ IMPORTANT

In the unlikely occasion that the slideout trim has inadequate clearances, try leveling or repositioning the coach and rechecking the clearances before extending the slideout.

7. Dump the air suspension (if equipped). This step is included in the auto-leveling process for most coaches.
8. Deploy the leveling jacks.

Retracting The Jacks and Slideouts

1. Retract the leveling jacks.
2. Start the coach.
3. Allow the coach air suspension to fill and return to ride height (units without air suspension will return to normal suspension).
4. Turn the engine off.
5. For a full wall slideout, visually inspect the front vertical trim for adequate clearance. The spacing should look even from top to bottom (see image for reference).

IMPORTANT

In the unlikely occasion that the slideout trim has inadequate clearances, try leveling or repositioning the coach and rechecking the clearances before retracting the slideout.

6. Verify that the path of the slideout is unobstructed and free from any surrounding objects, both inside and outside of the coach. This includes any water or debris that may have collected on the slideout roof or the topper awning.

IMPORTANT

Debris left on the roof or topper may prevent the slideout from sealing properly when retracted, as well as prevent the mechanical lock arms from closing properly when the slideout is extended.

7. Retract the slideouts. Inspect all slideouts for complete retraction.
8. If the coach is equipped with manual lock arms, make sure to lock them.
9. Unplug the coach from shore power when you are ready to depart.

Equalizer Leveling System Operation

This article provides the step-by-step instructions for operating an Equalizer leveling system.

This sequential leveling is a patented process that provides a more precise level throughout the length of the vehicle, adding stability to the vehicle while leveling it as low to the ground as possible. It's quick, easy and on the level!

WARNING

Read the Operation Manual for your specific leveling system, and follow all safety warnings and notices.

NOTICE

The keypad may be left on once level has been achieved. The keypad will enter 'sleep mode' after five minutes of inactivity.

IMPORTANT

The jacks down LED lights must be off for Auto-Level to function. If needed, press the ALL RETRACT button to clear and then Auto-Level should function.

Auto-Level Operation

POWER ON

Press and release the POWER button to engage power. All LED's on the panel will come on then most will go out. The LED next to the POWER button should be lit RED when power is on.

To extend the jacks, the ignition key must be in the engine run or on position and the park brake must be applied.

To retract, the ignition key must be in the engine run or on position.

If you attempt Auto-Level or All Retract you will hear a "deni" tone if the key or park brake is in the improper position.

AUTO-LEVEL

Press the AUTO-LEVEL button and release. The system will send out a continuous series of beeps, the 'OPERATING' LED will be on RED to let you know AUTO-LEVEL is operating and will automatically level the coach. When completed, the keypad will signal a successful level with a dual-level tone. Press and release the POWER button.

RETRACTING THE JACKS

NOTICE

If your coach is equipped with air suspension, it is recommended that the coach be started and chassis air pressure allowed to build before pressing ALL RETRACT. This will ensure adequate air supply to the chassis air valves.

To retract all jacks simultaneously, press and release the All RETRACT button. All jacks will automatically retract and return to stowed position. The pump will run in retract mode until all of the jacks are fully stowed (plus an additional 5 seconds) up to a maximum of 60 or 90 seconds). This is the proper method for retracting the jacks prior to travel.

You may stop the ALL RETRACT by pressing any button on the keypad. Jacks may be retracted in pairs by using the UP▲ button for each end or side for leveling purposes however the ALL RETRACT must be used to fully stow the jacks prior to travel.

The jacks down LED's will turn off, indicating the jacks are in the "stowed" position.

POWER OFF

Press and release the Power keypad button.

⚠ IMPORTANT

Visually confirm all jacks are retracted prior to travel.

EQ Smart-Level

Coaches in production after 5/17/2019 may be equipped with Smart-Level. Control the Equalizer leveling system via your smartphone! To download Equalizer's smartphone app, open up the iTunes or Android Play Store and type in "EQ Smart Level."



FEATURES

The Smart-Level has built in Bluetooth capabilities. Compatible with iPhone, Android, and ASA Electronics iN-Command Control System.

Manual Operation

POWER ON

Press and release the POWER keypad button to engage power. All LED's will come on then most will go out. The LED next to the POWER button should be lit RED when power is on.

EXTENDING JACKS MANUALLY

To extend the jacks the ignition key must be in the engine run or on position and the park brake must be applied. If you attempt to extend or retract jacks by pressing the DOWN▼ or UP▲ keypad buttons you will hear a "deny" tone from the keypad if the ignition key and or park brake is in the improper position.

PLANTING THE JACKS

The jacks will be extended in pairs Fronts or Rears or Left or Right Using the DOWN▼ (extend) keypad buttons, extend the jacks until they contact the ground (this is referred to as "planting" the jacks). As you extend each pair of jacks the corresponding LED jack status lights will come on to indicate jack(s) are out of the "stowed" position.

⚠ NOTICE

Jacks will be operated in pairs.

Extend and plant the front jacks first. Then extend and plant the rear jacks. Only after planting the fronts and then the rears, should side to side corrections (leveling) be attempted. This process will stabilize all four corners and minimize twist prior to the leveling process.

⚠ WARNING

Do not manually over extend jacks. This may cause unwanted stress on the coach or the jacks.

LEVELING THE COACH

Use a bubble level on a flat surface in the center of the coach as a reference. Level the vehicle by using DOWN▼ (extend) or UP▲ (retract) keypad buttons until the vehicle is level. Front to rear then side to side.

⚠ WARNING

Do not attempt to lift the vehicle tires off of the ground. Only lift (extend) enough to level and stabilize the unit.

Once level, press and release the POWER button to turn off the keypad.

⚠ NOTICE

The keypad may be left on once level has been achieved. The keypad will enter 'sleep mode' after five minutes of inactivity.

RETRACTING THE JACKS

⚠ NOTICE

If your coach is equipped with air suspension, it is recommended that the coach be started and chassis air pressure allowed to build before pressing ALL RETRACT. This will ensure adequate air supply to the chassis air valves.

To retract the jacks the key must be in the engine run or on position and the park brake must be applied. To retract all jacks simultaneously, press and release the ALL RETRACT button. All jacks will automatically retract and return to stowed position. The pump will run in retract mode until all of the jacks are fully stowed (plus an additional 5 seconds-up to a maximum of 60 or 90 seconds). This is the proper method for retracting the jacks prior to travel.

You may stop the ALL RETRACT by pressing any button on the keypad. Jacks may be retracted in pairs by using the UP▲ button for each end or side for leveling purposes. However, the ALL RETRACT must be used to fully stow the jacks prior to travel. The jacks down status LED lights will turn off, indicating the jacks are in the stowed position.

POWER OFF

Press and release the POWER keypad button.

IMPORTANT

Visually confirm all jacks are retracted prior to travel.

Fluid Level Maintenance

The hydraulic leveling system was filled with Dexron/ Mercon transmission fluid during production. Periodically check the fluid levels in the leveling system. The reservoir level should remain at 3/4 full when the jacks are retracted. Add fluid as needed. Change the fluid if debris or water enters the reservoir.

Source(s): Equalizer Systems Auto-Level Operation and Warranty Guide (Newmar, Rev. Jan. 2014)

Product(s): This source is associated with more than one product. Refer to Newgle for more information about the product(s) offered for your coach's model year.



Wheels and Tires

Wheels and Tires Size and D.O.T. Code

This article provides basic information about the wheels and tires, including the tire size, inflation, and D.O.T. codes.

Newmar's quality extends to every inch of your coach, right down to the tires and wheels. The durability and longevity of your tires will provide you with the confidence and peace of mind you need to relax and enjoy the ride.

The primary areas of concern are the tire size, inflation, and operational information. The sidewall of the tire contains detailed information about the construction, inflation, and carrying capacity of the tire. Become familiar with this information, and operate the vehicle within the capacity parameters outlined.

WARNING

Proper tire maintenance is critical to the safety, operation, and durability of your coach. Failure to follow and monitor tire pressure guidelines may result in premature tire failure.

This tire size is 315 / 80 R 22.5. From this size, we can determine the physical dimensions of the tire, as well as its basic construction. The tire size breaks down like this:

- The first number, "315", is the section width of the tire in millimeters. The section width is the measurement of the tire from the outside sidewall to the inside sidewall.
- The second number is the height of the sidewall, expressed as a percentage of the section width. In this case, the number is "80", so the sidewall height accounts for 80 percent of the tire's section width.
- The "R" in the tire size indicates that this tire is "radial" in construction. The belts are wrapped around the tire in a radial design, from bead to bead.
- The final number is "22.5", which is the rim size the tire was designed to fit. This tire fits a 22.5" diameter wheel.

Tire Size

The sidewall of the tire contains information that is important to know to ensure proper use of the tire, as well as to maintain long life. Take the time to become familiar with the size, load rating, and pressure information listed on the sidewalls of the tires.



D.O.T. Code

The last four digits on tires manufactured after the year 2000 signify the week and year of manufacture.



The tire in the example picture was made during the 29th week of 2017.

Tire Care and Maintenance

This article provides information about the care and maintenance of your coach tires, including examples of labels and tire pressure charts. To ensure your tires are operating safely, regularly inspecting your tires and checking your tire pressure is absolutely mandatory.

NOTICE!
CHECK WHEEL LUGS

On first trip, tighten wheel lugs at start and at 10, 25 and 50 miles. Tighten to manufacturer's specifications.

Thereafter, check wheel lugs before each trip, after excessive braking and following winter storage.

AD-24

Tire pressures should be checked and adjusted before and after each trip. Always check and adjust the pressures while the tires are cold. Never add or release pressure from the tires when they are hot (after having driven a mile or more).

For safe operation and maximum weight carrying capacity, it is imperative that the tires be inflated to and maintained at the listed tire pressures on the Federal ID Tag. This tag is affixed to the interior wall just behind the driver's seat in your coach.

⚠ WARNING

Failure to follow proper inflation guidelines may result in tire failure, which can cause loss of vehicle control or accidents resulting in property damage, bodily injury, or death.

⚠ IMPORTANT

The tire pressure settings can change depending on whether they are used in single or dual tire situations.

⚠ IMPORTANT

Make sure the tire pressures are the same across an axle, while never exceeding the maximum air pressure limit stamped on the wheels or tires, or leaving a tire below the minimum pressure listed on your tire inflation chart.

If you are operating your coach while staying significantly under the maximum weight carrying capacity, you may experience an unnecessarily firm ride. To correct this condition, it is recommended for you to weigh the coach when it is fully loaded as you would travel, with full fuel, water, and LP tanks, all travelers, and your belongings, as well as any towed equipment. Weigh each axle end separately, and use the heaviest end weight to determine the axle's cold inflation tire pressure.

For units operating significantly under maximum weight carrying capacity experiencing an unnecessarily firm ride. We recommend for you to weigh the coach loaded as you will be traveling with fuel, water, Lp, belongings, persons and weight of towed equipment, weighing each axle end separately and using the heaviest end weight to determine the axle's cold inflation tire pressure use the inflation chart provided by the tire manufacture for you specific brand, series, & size and load range of tire use the dual and single weight charts according to the tire configuration you are inflating.

Make sure tire pressures are the same across an axle, while NEVER exceeding the maximum air pressure limit stamped on the wheels or tires nor under inflating a tire below the lowest pressure on the tires inflation chart. For more detailed information refer to the tire inflation pressure article in Newgle.

295/60R22.5 J												
	85	90	95	100	105	110	115	120	125	130		
PSI	59	62	66	69	72	76	79	83	86	90	Maximum load & pressure on sidewall	
kPa	526	5505	5750	5990	6230	6465	6700	6930	7160	7390	7390 LBS at 130 PSI	
LBS	Single	9650	10100	10550	10990	11430	11860	12290	12720	13140	13560	6780 LBS at 130 PSI
	Dual	2385	2495	2610	2715	2825	2930	3040	3145	3230	3350	3350 KG at 900 kPa
KG	Single	4375	4580	4785	4985	5185	5380	5575	5770	5960	6150	3075 KG at 900 kPa
	Dual											

Example of a Tire Inflation Chart

Use the inflation chart provided by your specific tire manufacturer according to brand, series, size, and load range. Also, pay attention to the chart when referring to dual or single tire configurations, as they will change based upon which tire you are inflating.

⚠ IMPORTANT

Do not use the example to find your recommended tire pressures. Refer to your tire manufacturer's owner's manual and specific tire inflation guidelines.

⚠ NOTICE

Exact tire inflation charts will not be provided by Newmar. Each tire manufacturer provides this information, as it changes by brand, make, tire series, tire size, as well as if it is used in a single or dual setup. For more information about your tires and the inflation specifications, please refer to the Item Home Page of your tire manufacturer.

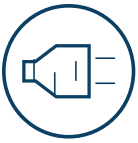

ELECTRICAL

This chapter includes overviews of the 12 volt and 120 volt electrical systems, as well as information about electrical equipment that may be installed in your coach, including, but not limited to fuse panels, lighting, EMS, generators, inverters, converters, solar panels, transfer switches, etc.

WARNING

Due to the risk of electrical shock, service should be performed by a qualified electrician or authorized service technician. The electrical system may have multiple 120/240 volt power sources. All power sources must be turned off, and any auto generator start features must be disabled prior to servicing.

IMPORTANT

Any of the following quick start instructions provided by Newmar should not take the place of the manufacturer's complete documentation. Refer to Newgle for more information about electrical components offered for your coach's model year.



12 Volt Electrical System

This article provides general information about the components and functions of the 12 Volt Electrical System (DC) in Newmar coaches.

Power Sources

The 12 Volt Electrical System allows certain components to maintain a low voltage from the battery bank. The battery bank is controlled by the coach charging system, which consists of a charge bridge solenoid, a bi-directional isolator relay delay (BIRD), or a battery isolation manager (BIM). When the coach engine is running, the alternator charges the chassis batteries and may assist in charging the house batteries through the BIM, BIRD, or Charge Bridge.

When the coach is connected to shore power or when the coach generator is in use (when shore power is unavailable), the converter or inverter/converter combination recharges the house batteries, and with the assistance of a BIM, BIRD, or Charge Bridge, it can also charge the chassis batteries.

In addition to the alternator and converter, the coach may also be equipped with solar panels to provide an additional option for charging your house batteries.

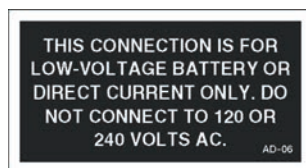

ALTERNATOR

The alternator is a belt-driven component attached to the coach engine and is supplied by the chassis manufacturer. The alternator supplies power for chassis components such as batteries, lights, wipers, dash HVAC, and power seats, as well as all of the driver controls located in the cockpit. The alternator charges the chassis batteries, but with the addition of a BIM, BIRD, or Charge Bridge, it may also assist in charging the coach's house batteries.

GENERATOR

When shore power is unavailable, the generator takes mechanical energy and converts it into alternating current to supply 120 volts to the coach and charge the coach's house via the converter or inverter/converter and the chassis batteries via BIRD, BIM, or charge bridge.

The generator is typically located in the front of the unit between the frame rails on diesel coaches. On gas units, the generator may be located anywhere between the mid and rear section of the coach. Generators can be powered by gas, liquid propane, or diesel fuel.

CONVERTER AND INVERTER/ CONVERTER COMBINATION

All Newmar coaches are equipped with a converter or inverter/converter combination. A converter transforms alternating current or shore line power 120 Volts to low-voltage direct current to provide power to the coach's 12 Volt house and chassis batteries. On the other hand, an inverter transforms direct current to alternating current to provide power to specified appliances and entertainment systems.

SOLAR PANEL

Some Newmar units are equipped with a 10 Watt solar panel wired to the chassis batteries. Prior models may have a five or 10 Watt solar panel and may be wired to the chassis-side KIB panel.

BATTERIES

Please refer to the Battery Basics article for more information.

Power Distribution

BATTERY DISCONNECT

Newmar uses an Intellitec disconnect relay connected to the battery bank to disconnect certain loads when placing the coach in storage. Keep in mind that not all loads are disconnected. This is very important to remember when a coach is put into storage and is not plugged into shore power. Before placing the battery disconnect in the “off” position, make sure the inverter (if equipped) is turned off.



When an older coach is stored while plugged into shore power, do not use the battery disconnect. If the battery disconnect is used, the chassis batteries will not receive a charge from the converter or inverter/converter combination. This is due to the coach battery wire being disconnected, meaning the BIM or the BIRD will not engage.

Some coach models have a manual rotary key switch to disconnect power, which is located in the overhead above the entry door. Most other coaches have a single lighted switch located in the front overhead that turns off the house voltage.

⚠ IMPORTANT

When the battery disconnect is ‘off’, meaning you have disconnected components from the batteries, there are still some loads on the batteries connected to the hot side of the Battery Disconnect Relay. Some of these loads may be Radio Memory, Entry Steps, and LP Detector. These will draw from the batteries, even when the disconnect is ‘off’. Pull the fuse for each of the ‘HOT’ circuits to stop the batteries from being drained.

To learn more, visit the Battery Disconnect home page in Newgle.

BI-DIRECTIONAL ISOLATOR RELAY DELAY (BIRD)

Current gas coaches and some older diesel coaches, use an Intellitec Bi-Directional Isolator Relay Delay (BIRD) with a separate solenoid. The BIRD monitors both the chassis and house battery and is the only place in the coach where they both merge. The BIRD only functions when the engine or generator is running or when the coach is connected to shore power.



To learn more, visit the Bi-Directional Isolator Relay Delay home page in Newgle.

BATTERY ISOLATION MANAGER (BIM)



All current Kountry Star, Super Star, Dutch Star, and Ventana diesel coaches use a Precision Circuits all-in-one Battery Isolation Manager (BIM). The BIM monitors both the chassis and house battery and is the only place in the coach where they both merge. The BIM only functions when the engine or generator is running or when the coach is connected to shore power.

To learn more, visit the Battery Isolation Manager home page in Newgle.

CHARGE BRIDGE SOLENOID

All current model New Aire, Supreme Aire, Mountain Aire, London Aire, Essex, and King Aire coaches use Silverleaf, a computerized coach management system.



One of its many functions is to control the battery charging through the Charge Bridge Solenoid. The TM102 module monitors the battery state and senses the house and chassis battery voltage. When the parameters are met, the TM102 module activates the solenoid, causing it to bridge or connect the chassis and house battery banks.

For more information on your coach’s TM102 module, refer to the SilverLeaf Functional Guide in Newgle.

FUSE BLOCKS AND MINI-BREAKERS

When a 12 Volt wire is ran, most of the circuits are protected with fuses or mini-breakers. These can be located at various areas in the coach but are typically located near the main breaker panel. The following photos are examples only. However, they may also be found in areas such as:

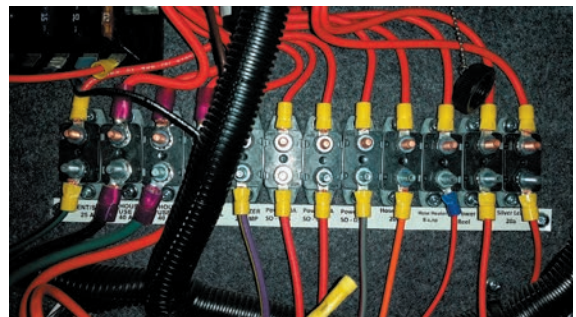

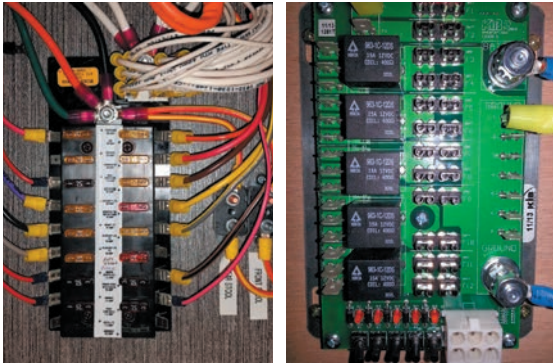
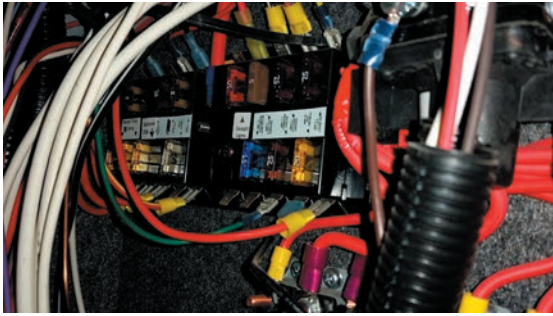

Basic 12 Volt Power Flow

Since a battery is only an electrical storage component, 120 Volt power must be present to charge the batteries from the converter or inverter/converter combination unit. It is necessary to have 12 Volt power supplied from the coach's house battery bank in order to operate the interior lights and other 12 Volt loads such as slideout control systems, water pumps, vent fans, monitoring systems, etc.

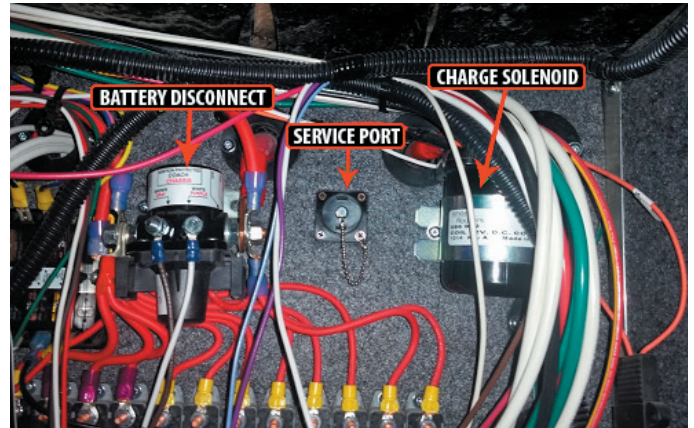

Most of this power flows through the battery disconnect to the fuse block or mini-breakers, which prevents overloading the circuit prior to progressing to the 12 Volt load. There are some 12 Volt circuits that do not go through the house battery disconnect; however, these loads still pass through a fuse or mini-breaker before progressing to the load.

INTERIOR

- Rear bedroom
- Rear bathroom
- Closet
- Front Overhead Cabinet

EXTERIOR

- Power cord compartment
- Left, front electrical compartment (located beneath the driver window)
- Front firewall (gas coaches)

There are also some circuits that are protected with an inline fuse. Some fuse blocks have fixed relays integrated on a board. The board below is located in the cord compartment.

IMPORTANT

When a 12 Volt load or component is not working, both 12 Volt power (+) and 12 Volt ground (-) are needed for the load to complete the 12 Volt circuit.

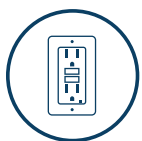

120 Volt Electrical System

This article provides general information about the components and functions of the 120 Volt Electrical System (AC) in Newmar coaches.

Power Sources

There are three types of alternating current (AC) power sources available to the coach: shore power, generator power, and inverter power. Shore power is provided by the RV park or by home service outlets and should be used whenever possible. Generator power should mainly be used when shore power is not available, specifically while traveling, when 120 Volt power is necessary to run high amperage loads, or when dry camping requires 120 Volt for battery charging. Inverted power is mainly used for light 120 Volt loads when shore power is not available and generator power is not desired.

GENERATOR POWER

Generator power is produced within the generator and is output through the main wiring to the transfer switch. From the transfer switch, the power moves to the main breaker box where it is dispersed to individual circuits (outlets) and hard-wired components such as a water heater or boiler. From the inverted circuits, generator power will then travel through the inverter's internal transfer switch and back to the inverted subpanel to be dispersed through the individual breakers to the outlets or appliances.

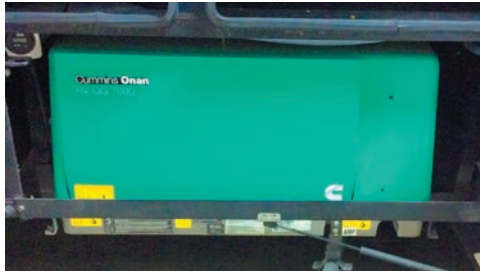

INVERTER POWER

This type of power starts at the battery bank. The battery bank supplies 12 Volt power through cables to the inverter, which uses the 12 Volt direct current to produce 120 Volt alternating current. The inverter performs this action by using a transformer to increase the voltage and modify the higher voltage into a useable alternating current power. Power then goes to the inverted sub panel, which is dispersed through the individual breakers to the outlets or appliances.



The inverter may provide battery charging while 120 Volts is supplied via the generator or shore power. The inverter performs this action by using the transformer to decrease the voltage and rectify the alternating current into useable direct current voltage. This is regulated by internal sensing circuitry based upon the battery bank's state of charge and several other factors, depending on the coach's particular inverter brand and type.

SHORE POWER

Most RV parks provide 30 Amp, 120 Volt at the site; however, many parks also provide 50 Amp, 240 Volt service to accommodate the electrical needs of newer and larger coaches. Shore power is supplied to the coach via a power cord. Two sizes of power cords are found in Newmar coaches: 50 Amp and 30 Amp. The 50 Amp cords are made up of four conductors #8 stranded wire and a molded plug. The 30 Amp cords are made up of three conductors #10 stranded wire and a molded plug.



Shore power enters through the 30 or 50 Amp power cord to the power cord reel (if equipped). From the power cord reel, it travels to the transfer switch and then to the main breaker box where it is dispersed to the individual circuits to supply power to hard-wired components such as air conditioners, water heaters, etc. and then to the inverter (if equipped).

The inverted circuits move from the inverter's internal transfer switch to the inverter subpanel (a smaller breaker box). From the subpanel, the power circulates to the individual breakers and to the electrical outlets and appliances.

SHORE POWER ADAPTERS

⚠ IMPORTANT

Newmar Corporation does not recommend use of adapter, cheater, or dog-bone style connectors that will modify the existing shore power cord to a different style of outlet. Use of this type of adapter will greatly reduce the amount of available current in the unit, as well as create the potential for electrical failure and/or fire.

If an adapter is used, there are three common sizes of power cord adapters available to adjust to a smaller amperage outlet:

1. 30 amp to 20 amp
2. 50 amp to 20 amp
3. 50 amp to 30 amp



It is important to understand the risks involved and the possible effects of using adapters in conjunction with your coach. Some of these risks and possible effects include:

- Melted or damaged adapters causing poor connection (or no connection at all)
- Melted or damaged 30 or 50 Amp plugs causing fluctuations in voltage that may damage electronics
- Insufficient amperage causing the tripping of a breaker at the post or a limited use of appliances

Low voltage can also be caused by use of adapters, long extension cords, or extension cords with an insufficient wire size.

⚠ IMPORTANT

Newmar Corporation cannot assume liability for failures occurring to the RV, its electrical system, or any of its components from the use of any electrical adapter.

AUTOMATIC TRANSFER SWITCH

Current coaches with a generator will also have a transfer switch installed in the cord compartment. An automatic transfer switch converts two inputs and connects them to a single common output.



The shore power cord is connected to one of the inputs, while the generator is connected to the transfer switch's second input.

Automatic transfer switches are logic-controlled to convert under a given set of conditions. The transfer switches used in RVs are typically generator priority switches which connect to shore power under normal use. As soon as the transfer switch detects the presence of 120 Volt power on the generator input lines, it will switch over to the generator's inputs and drop the connection to shore power.

Transfer switches are designed so that only one input can be connected at a time in order to prevent any back feeding of electrical power. In addition, RV transfer switches generally have a built-in delay allowing the generator to warm up and speed up before actually switching the load. This prevents stalling or stumbling while the engine is still cold and not producing full power.

MAIN SERVICE PANEL BREAKER BOX

The main service panel or 120 Volt breaker box is typically located inside a bathroom, bedroom, or front overhead cabinet depending on the coach model and floor plan. The breaker box contains the main 50 Amp (or 30 Amp if equipped) breaker and the individual breakers protecting each circuit from overload conditions. Any unit equipped with two air conditioners or more must have 50 Amp service. The task of the breaker is to "trip" if the current exceeds the amperage rating on the breaker to prevent damage to the wiring of the circuit.



The breakers are resettable by simply flipping the breaker to the 'off' position, and then back to the 'on' position once the overload condition is removed. All 120 Volt circuit breakers are located in the main service panel unless the coach is equipped with an inverter/charger. These units are also equipped with a subpanel.

IMPORTANT

Breakers positioned next to each other are on different poles in a 50 Amp panel. If only part of the electrical circuits are working, you may have a poor connection at shore power. In this instance, power is most likely only being provided to one pole or leg.

SUBPANEL

The subpanel is a smaller 120 Volt breaker box containing the breakers for the circuits which the inverter is wired to power. It is typically located near the main breaker box unless the coach is equipped with an Energy Management System (EMS). In this case, the subpanel is often located within the EMS panel. The subpanel is installed to limit the AC power use to specific circuits when the electricity is supplied by the inverter. Some inverters may be used to power a specific circuit. In this case, a subpanel is not used.



AUTOMATIC GENERATOR START (AGS)

On coaches equipped with AGS, the generator will start and provide 120 Volt power if the incoming shore power voltage is not present and startup parameters are met.

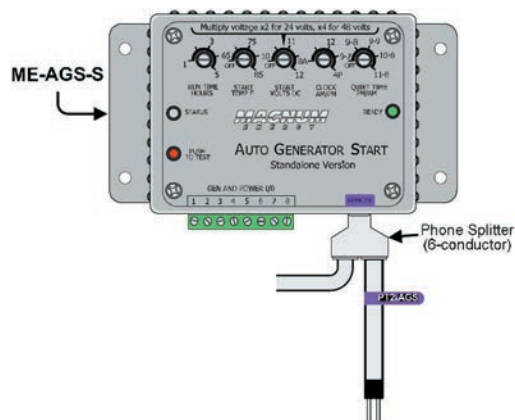

▲ IMPORTANT

This function must be enabled in order for the AGS to function properly.

The AGS may be controlled via the ME-AGS or SilverLeaf. ME-PT2 can be used in conjunction with the Dometic Duo-Therm kit and Comfort Control Center (CCC II Thermostat) or KIB L-Panel to connect the t-stat output of the A/C directly to the AGS. This allows the AGS to start on demand from the A/C for either heat (heat pump only) or cool.

1. Follow Comfort Control Center or KIB L-Panel instructions for proper zones, heat, cool and AGS settings.
2. The ME-AGS-S will now start on demand from the Comfort Control Center or KIB L-Panel.

For more information about AGS operation via the SilverLeaf system, refer the year/model-specific SilverLeaf Touchscreen Guide in Newgle.

50 AMP ENERGY MANAGEMENT SYSTEM (EMS)

The 50 Amp Precision Circuits Energy Management System is currently offered as standard or optional equipment on all coaches not equipped with a SilverLeaf Coach Management System. Its function is to provide power management for certain 120 Volt loads and as a system of energy management to minimize the overloading and tripping of circuit breakers. The EMS contains a main distribution panel with a self-contained control module and a remote display panel, which is typically located in the dash overhead electrical control cabinet.



The EMS control module automatically senses the available power being supplied to the coach. The module determines whether it is connected to a 50 Amp (240 Volt) or the generator. On 120 Volt service, it is unable to determine if the source is providing 30, 20 or 15 Amp shore power. Depending on available power, it can control up to seven loads.

The EMS controls air conditioner loads using low-voltage switching and other 120 Volt, heavy-load appliances, such as block heaters, water heating elements, and air conditioners. The EMS will also control the 2012 Magnum inverter charge rate or switch to invert depending on the charging status. The charger will only reduce once it is in float status.

The current-sensing relay will display the amperage on each leg. The EMS will start shedding loads and look at the AC current when it sheds a load, determining when it has enough current available to turn on the load again.

When the EMS sheds a load, it only looks at one leg to see how much of a load was shed. For coaches equipped with the SilverLeaf system, refer to the SilverLeaf Functional Guide for more information on your EMS.

CONVERTERS

All Newmar coaches are equipped with a converter or an inverter/converter combination. Converters are used to transform alternating current power (120 Volt AC) to direct current power (12 Volt DC). Converters supply the coach with 12 Volt power to operate systems in the coach and provide battery charging.



Newmar currently uses three sizes of converters: 45, 60, and 80 Amp models. Previous units may have a 55 or 75 Amp converter or two 45 Amp converters with a total of 90 Amps available. When replacing a converter, it is necessary to use the same size converter to ensure sufficient wiring and breakers for the converter's input and output ratings.

Possible causes of converter failure:

- Overheating caused by cooling fan malfunction or inadequate ventilation causing damage to the converter
- Blown fuses

INVERTERS

An inverter changes 12 Volt DC power to 120 Volt AC power. Coaches with an inverter only typically use it for powering the entertainment equipment like the TV, DVD, and Blu-ray players. The inverters used for this purpose are usually 600 watt to 1000 watt (1000 Watt inverters may also power a small refrigerator) and do not have battery charging capability.



The inverters are usually located in a basement compartment of the coach. Some inverters have a remote panel for an on/off switch in the overhead driver area or above the entry door. When power is supplied by either the generator or shore power, the inverter merely allows the power to “pass through” and will then stop pulling power from the batteries to try and supply 120 Volt power. There is a protective breaker on the inverter to prevent circuit overload.

Possible causes for inverter failure:

- Overheating caused by inadequate ventilation causing damage to the inverter
- Overloading the circuit causing “tripped” breakers

INVERTER/CONVERTER COMBINATIONS

Many Newmar coaches are equipped with inverter/charger combination units, sometimes referred to as an inverter/converter unit. These units range from 1200 to 3000 Watt and serve as a three stage charger and an inverter. Coaches equipped with this option will also be equipped with a 120 Volt subpanel.



The subpanel is used to limit the circuits powered by the inverter(s). This is necessary to avoid draining the batteries by supplying inverted power to all circuits. The subpanel is located next to the main service panel. On units equipped with an EMS, the subpanel is located in the same breaker box but is separated in the interior of main panel. The coach battery bank supplies the inverter 12 Volt power and has a high amp fuse link on the positive lead from the batteries and is located near the battery bank.

The inverter/charger can be controlled by a remote panel, from another system like SilverLeaf, or at the inverter itself. The remote panel is typically located in the front overhead compartment or above the entry door and is used to control the inverter and the battery charging functions. If a remote panel is connected to the inverter, then the remote panel takes priority.

THREE-STAGE CHARGING PROCESS

The charging cycle uses three states: bulk, absorption, and float. During the initial bulk stage, the inverter charges at near its full current ability. This causing the battery voltage to rise over time. After the battery voltage reaches the bulk voltage setting, the charger starts the absorption stage.

During this phase, the charge rate is gradually reduced while the battery voltage is held near the bulk voltage setting. This insures that the battery is fully charged. The float stage is initiated when the battery has been held at the bulk voltage setting for the absorption period. At this point the battery voltage is allowed to fall to the float voltage setting, where it is maintained until another charge cycle is initiated. This reduces gassing of the battery and keeps it fully charged. A new three stage charging cycle is initiated after an AC source is reapplied to the AC input terminals.

GROUND FAULT CIRCUIT INTERRUPT (GFCI) OUTLETS

The Ground Fault Circuit Interrupt (GFCI) outlets protect the user from ground faults between a hot wire and ground. The 120 Volt electrical outlets in the kitchen and bath area are GFCI protected receptacles. The electrical outlets located in the Slideouts are wired through the kitchen GFCI. The exterior electrical outlets are wired through the bathroom GFCI. On units equipped with the floor heat option, a separate GFCI is installed in the bathroom or near the main breaker box. Units with the holding tank heat pad option will have an additional GFCI located in the basement area; however, the exact location varies.



The GFCI outlets should be tested at least once a month. The 120 Volt electrical system must be energized in order to test the GFCI. The reset button needs to be pressed before starting the test. Then push the test button, which will cause the reset button to pop out, confirming the protected circuits have been disconnected. Push the reset button again until a click is heard to reactivate the protected circuit. If the GFCI is working properly, the reset button will remain in the “IN” position. If an item plugged into a Slideout or outside receptacle is not working, check for a tripped GFCI in the kitchen or bathroom. Likewise, if the floor heat or holding tank heat pads are not working, check the GFCI for that circuit.

WARNING

The GFCI will not reduce the shock hazard if the short is between a neutral and hot wire or two hot load wires.

120 VOLT OUTLETS

Several 120 volt receptacles are located throughout the interior of the unit. These receptacles require three-pin plugs that provide proper grounding to protect you from electrical shock. The breaker for the outlets are usually located in the breaker box. If the breakers are on the inverted circuitry, they will be located in the subpanel near the main breaker box.



⚠ IMPORTANT

Do not use an adapter, cheater, or extension cord that breaks the continuity of the ground circuit to the ground pin. Never remove the ground pin from a plug in order to connect it to a two-pronged ungrounded outlet.

Electrical Typical Amp Draw List

This article provides a basic overview of the typical amp draw of electrical components and appliances in a coach.

Knowing and understanding the electrical terminology, as well as the average amperage (current draw) of all the electrical appliances in your coach, can help you manage electrical use and prevent the inconvenience of tripping a breaker.

Amp Draw

Do you know how many Amps you are using at any single moment? It is surprising how quickly the current draw (Amps) of your appliances can add up for your coach's 30 or 50 Amp system. Knowing and understanding the electrical terminology, as well as the average amperage (current draw) of all the electrical appliances in your coach, can help you manage electrical use and prevent the inconvenience of tripping a breaker.

Below is a list of the typical appliances used and the approximate amps required to operate them.

- V = volt; volt is the measurement of electrical pressure
- A = amp; amp is the measurement of electrical current (volume) used by an electrical device.
- W = watt; watt is the measurement of how much electrical work is being done.

Appliance	Required Amps
Air Conditioner (depending on brand, BTU rating and options)	14.0 to 16.0 Amps
Inverter (depending on wattage rating, brand, and model)	9.0 to 18.0 Amps
Converter with continuous 12 volt power supply (depending on amp rating and brand)	11 to 17 Amps
Refrigerator (residential compressor-type)	8.5 to 12.0 Amps
RV Refrigerator (Absorption)	2.7 to 6.4 Amps
Microwave Oven	11.3 to 14.2 Amps
Washer and Dryer (2-piece)	16.0 Amps
Television (depending on size, brand, and type)	1.0 to 3.0 amps
Central Vacuum Cleaner	11.3 Amps
Electric Hot Water Heater (depending on brand and type)	11.7 to 12.5 Amps
Food Processor	6.0 Amps
Ice Maker	4.0 Amps
Electric Freezer (Compressor)	6.4 Amps
Hair Dryer (1500w)	12.5 Amps
Electric Coffee Pot	9.0 Amps
Iron	10.0 Amps
Radio	0.8 Amps
Toaster	8.0 Amps
Electric Frying Pan	10.0 Amps
Coffee Maker	10.0 Amps

Conversions

You can look at at your electrical appliances, find the label that contains amperage or wattage ratings and calculate exact usage by using the formulas below.

- Watts/Volts = Amps
- Amps x Volts = Watts
- Watts/Amps = Volts

EXAMPLE

Most products requiring electricity provide how many amps or watts it typically utilizes. If your electric hot water heater is always in use (~12.5 amps), and you start your air conditioner (~15.0 Amps) and put on a pot of coffee (~9.0 amps) and make some toast (~8.0 amps) while watching TV (~ 2.0 amps), you have far exceeded the 30 amp service, resulting in a tripped breaker.

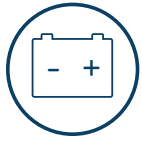

Batteries

Provides information about the house and chassis battery banks, battery inspection and care, as well as battery replacement.

Battery Basics

Introduction

As with anything technical, greater knowledge of the basics may help you increase performance, reliability, and longevity, as well as prevent future problems with your batteries. This article will provide information regarding your coach batteries; however, this is only one aspect of your coach's electrical system. To learn more about your batteries' role within the system, please refer to the 12 Volt Electrical article.

Commercial lead acid batteries have been used for over 150 years. The same chemical principal used to store energy now was also used many generations ago. Present day chassis battery power requirements are tremendous, considering today's vehicles and all of the electrical devices that must be supplied. All of these electronics require a reliable power source, and poor battery condition may lead to expensive electronic component failure. A battery is like a piggy bank - it stores energy, but cannot produce it. If you continue to withdraw without making any deposits, you will soon have nothing left.

Life Span of A Battery

Not long ago, motor homes only used a single 12 Volt house battery. Today, however, it is standard to have at least two batteries, and up to 16 total in some Newmar coaches, powering inverters up to 3000 watts. As energy requirements increase, the average battery life decreases. The life span of a deep cycle battery will vary considerably with how it is used, how it is maintained and charged, temperature, and other factors. The life span is dependent upon usage but often ranges between six months to 48 months. Only 30 percent of all batteries actually reach the 48 month mark.

It is best practice to change the complete battery bank when a new battery becomes necessary, as the battery bank is only as good as the weakest cell. One simple way to extend battery life is to hook it up to a solar charger during the off months.

Many people don't take into consideration how much power may be used by the inverters charging circuits mostly because they are working automatically in the background. 50 amp service has two 50 amp power legs, providing a total service of 100 amps.

Common Battery Terms

Ampere (Amp) - A unit that defines the flow rate of electricity (current) in a circuit.

Amp Hour (AH) - Measurement of electrical storage capacity on a deep cycle battery. The standard amp rating is taken for 20 hours. Example: A 100 AH rated battery is determined like this: Draw from the battery for 20 hours provides a total of 100 amp hours, translating to about five amps an hour (5 amps x 20 hours = 100 AH). However, it is important to know that the total time of discharge and load applied is not a linear relationship. As your load increases, your realized capacity decreases. This means if you discharged that same 100 AH battery by a 100 amp load, it will not give you one hour of runtime. On the contrary, the perceived capacity of the battery will be about 64 AH.

Cold Cranking Amps (CCA) - Measures the number of amps a battery can deliver at 0° F for 30 seconds without dropping below 7.2 Volts (1.2 Volts per cell). A high CCA battery rating is especially important in engine-starting battery applications and in cold weather. This measurement is not particularly important in deep cycle batteries, though it is the most commonly known battery measurement.

Cranking Amps (CA) - Measures available current at 32° F and is also called marine cranking amps (MCA).

Depth of Discharge (DOD) - Measures the percent of rated capacity to which a cell or battery is discharged. It is the reciprocal of a battery's state of charge. Example: A battery that has a depth of discharge of 45 percent has a state of charge of 55 percent.

Reserve Capacity (RC) - Measures the number of minutes a fully charged battery can continuously deliver 25 amps at 80 ° F before the voltage drops below 10.5 Volts. This measurement represents the amount of time the battery can operate if a charging system failure occurs.

Electrolyte Specific Gravity (battery test) - Unit of measure which compares the weight of the electrolyte solution to the weight of water. This test is performed with a hydrometer or a refractometer that is made for testing batteries. This type of test is used to determine the battery's state of charge; however, it cannot be used on sealed batteries.

Battery Types

LIQUID LEAD ACID / FLOODED

The Lead Acid battery consists of a plastic container with cells molded into it. Each cell contains plates, lead, and lead oxide (various other elements are used to change density, hardness, porosity, etc.) with 35 percent sulfuric acid and a 65 percent water solution. This solution is called an electrolyte, which causes a chemical reaction that releases electrons.

When testing a battery with a hydrometer, the amount of sulfuric acid in the electrolyte is measured. If the reading is low, the chemistry that makes electrons is lacking. The sulfur is now resting on the battery plates and will remain there until the battery is recharged and the sulfur returns to the electrolyte.

⚠ CAUTION

Use only distilled water to fill flooded / liquid lead acid batteries.

ABSORBED GLASS MAT (AGM) / DRY CELL

The Absorbed Glass Mat battery is just like a flooded battery, except the electricity is maintained in the glass mats, as opposed to freely flooding the plates. Very thin fibers are woven into a mat to increase the surface area to hold sufficient electrolyte on the cells for their lifetime. The construction allows the electrolyte to remain suspended in close proximity with the plate's active material, enhancing both the discharge and recharge efficiency.

When Deep Cycle AGM batteries are not discharged more than 60 percent, the cycle life could be approximately a few hundred cycles. If you do not use or operate your equipment daily, AGM batteries will hold their charge better than most other types. In most cases AGM batteries will provide a greater life span and cycle life than a Wet Cell battery.

AGM batteries are also often referred to as Sealed Regulated Valve, Dry Cell, Non-Spillable, and Valve-Regulated Lead Acid batteries.

⚠ CAUTION

Follow battery manufacturer instructions. Do not add any liquid to AGM batteries.

GEL CELL BATTERIES

The Gel Cell is similar to the AGM battery because the electrolyte is suspended; however, the AGM battery is still considered to be a wet cell. The electrolyte in a Gel Cell has a silica additive that causes it to set (gel) or stiffen. The recharge voltage on this type of cell is lower than the other types of lead acid batteries, due to the likelihood of an adverse reaction to over-voltage charging. Gel Cell batteries are best used in very deep cycle applications and may last longer in hot weather applications.

⚠ CAUTION

Follow battery manufacturer instructions. Do not add any liquid to gel cell batteries.

For more information about Battery Inspection, Safety, Care, and Maintenance, refer to Newgle.

Battery Bank Wiring

PARALLEL BATTERY WIRING

Parallel battery wiring refers to two or more batteries with all positive (+) terminals hooked together and all negative (-) terminals hooked together. This results in a battery voltage similar to that of the individual batteries, typically 12 Volt, to boost battery capacity. Two identical batteries wired parallel will provide twice the electrical storage capacity of one battery, without increasing voltage.

SERIES BATTERY WIRING

Series wiring refers to two or more batteries hooked together, with opposite terminals connected. The positive (+) terminal of the first battery should be connected to the negative (-) terminal of the second battery. The resulting voltage is the sum of the individual batteries. For example, if two six Volt batteries are hooked together, the resulting voltage will be 12 Volts.

SERIES/PARALLEL WIRING

Series/ Parallel battery wiring is used on Newmar units when four or more 6 Volt batteries are used for the house battery bank. Since 12 Volts is the desired working voltage from the battery bank, the batteries are connected to provide 12 Volts with more capacity. Two 6 volt batteries wired together in a series create a 12 Volt battery bank. Two or more of the 12 Volt battery banks can be connected together in a parallel format to provide more capacity.

In situations where multiple batteries are connected in a series, parallel or series/parallel, replacement batteries should be the same size, type, and manufacturer (if possible). Age and usage level should be the same as the companion batteries.

Battery Cycle Vs. Battery Life

A battery cycle is one complete discharge and recharge cycle (100 percent to 20 percent, and then back to 100 percent). Battery life is directly related to how deep the battery is cycled each time. The most common cycles are 10, 20, and 50 percent. Be cautious of ratings that list the number of cycles, unless it also states how low the battery is being discharged.

For example, telephone type (float service) batteries have been advertised as having a 20-year life. However, the rating only stands true at five percent depth of discharge (DOD), and the life span is much less when used in an application where the batteries are cycled deeper on a regular basis. Those same batteries are rated at less than five years if cycled to 50 percent.

If a battery is discharged to 50 percent every day, it will last about twice as long as if it is cycled to 80 percent DOD. If cycled only 10 percent DOD, it will last about five times as long as one cycled to 50 percent. The most practical number to use is 50 percent DOD on a regular basis for the best use of effective storage and cost.

Battery State/Voltage Chart

State of Charge	Specific Gravity	12 Volt	6 Volt
100%	1.265	12.7	6.3
75%	1.225	12.4	6.2
50%	1.190	12.2	6.1
25%	1.155	12.0	6.0
Discharged	1.120	11.9	6.0

Note: Both voltage and specific gravity tests should be performed with no load on the batteries and without any supplied charging. Turn off all draws and charging. Allow the batteries to stabilize, and then proceed with the test.

House and Chassis Battery Bank Overview

This article provides a brief overview of the two different battery banks in a Newmar coach: House and Chassis.

Chassis Battery Bank

The Chassis Battery Bank supplies power to everything a customer requires to drive the unit. Currently, Newmar's chassis batteries are all Liquid Lead Acid. Spartan and Ford chassis have serviceable batteries and Freightliner chassis batteries are sealed. The type and brand of chassis battery may vary depending on coach year, make, and model. Chassis batteries may need to be disconnected and removed from the coach to maintain proper electrolyte levels or perform routine battery maintenance. House batteries may be either serviceable Liquid Lead Acid/Flooded or AGM/Sealed Cell.

The chassis batteries on your motorhome are installed and warranted by the chassis manufacturer. The coach (or house) batteries on your motorhome are installed by Newmar Corporation, but warranted by the battery manufacturer. These batteries are used to operate the 12 volt items that are not a direct part of the chassis. Depending on the coach, the batteries may be located in the front of the coach under the front cap or on a pull out tray in an outside compartment.

The chassis batteries are recharged by the vehicle's electrical system whenever the engine is running, with added BIRD, BIM, or Charge bridge solenoids the vehicle's charging system will also charge house batteries if parameters are met. A decline in the coach battery voltage may be noticed while the chassis batteries are being charged.

The converter will automatically charge the coach batteries when the unit is connected to a 120 volt outside power source. The chassis batteries are isolated from the coach batteries, however with certain parameters met the BIRD, BIM, or Charge bridge will activate and allow charge to the chassis battery also. This prevents the chassis batteries from being drained by the interior 12 volt equipment, allowing ample voltage for engine ignition.

In addition, there is an upper limit. A battery that is continually cycled down five percent or less will usually not last as long as one cycled down 10 percent. At very shallow cycles, lead dioxide tends to build up in clumps on the positive plates rather than in an even layer.

IMPORTANT

This battery state voltage chart is used as an example. Your specific battery manufacturer's chart may vary.

CAUTION

Do not use the motorhome with the coach batteries disconnected.



Chassis Battery Bank Example

House Battery Bank

The House Battery Bank is necessary to operate everything a customer may require in order to live in the unit. These batteries can be either 6 Volt deep cycle (all diesel coaches) or 12 Volt deep cycle, depending on the model and brand of the coach. Newmar house batteries may be serviceable or sealed.



House Battery Bank Example

Battery Boost Switch Overview

This article provides the Newmar-recommended step-by-step instructions for operating the battery boost switch.

The Battery Boost switch is located on the dash and, when pressed, momentarily connects the house batteries to the chassis batteries via the solenoid. This allows the chassis batteries to obtain power from the house batteries to assist in starting the engine.

If the chassis batteries cannot turn the engine over, hold down the Battery Boost switch and attempt ignition. By using the Battery Boost switch while trying to start the chassis engine, the house battery bank supplies a battery voltage boost to the chassis batteries if the house battery bank voltage is higher than the chassis battery bank.

If the battery boost switch is required to start the engine on a regular basis, ask your dealer to check the chassis batteries and charging system. 2019 and newer diesel pusher coaches may have a dual position battery boost switch. This simply allows the chassis battery to be boosted from the house battery bank or the house battery bank boosted from the chassis battery, allowing the solenoid to operate from either source that has power to engage the boost solenoid. Once a click is heard, the solenoid has been energized and the battery voltage will be able to flow from the battery bank with the higher voltage to the battery bank with the lower voltage.



Ford Chassis Battery Overview

This article provides an overview of the Ford chassis battery bank.

Ford chassis batteries are serviceable liquid lead acid batteries. They are provided with the chassis and warranted through the chassis manufacturer (Ford). The type and brand of chassis battery may vary depending on the coach year, make, and model. Chassis batteries may need to be disconnected and removed from the coach to perform routine battery maintenance.

The chassis batteries are recharged by the vehicle's electrical system whenever the engine is running. With an added BIRD or BIM controlled solenoid, the vehicle's charging system will also charge the house batteries if parameters are met.

The inverter charger will automatically charge the coach batteries when the coach is connected to a 120 volt outside power source or with the generator running. The chassis batteries are isolated from the coach batteries; however, when certain parameters are met, the BIRD or BIM will activate and allow charge to the chassis battery. This prevents the chassis batteries from being drained by the interior 12 volt equipment, allowing ample voltage for engine ignition.

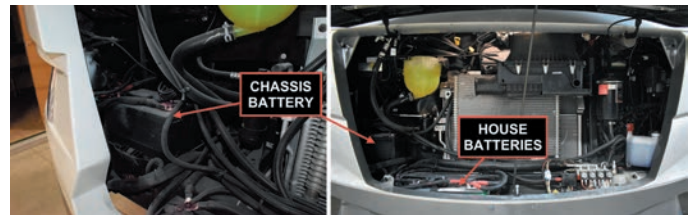

House Battery Disconnect Overview for Gas Coaches

This article provides information about the battery disconnect switch installed in a gas coach.

The House Battery Disconnect Switch is used to control the disconnect relay connected to the battery bank and is typically located in the front overhead control panel. This switch disconnects most loads when placing the coach in storage or when the coach is not in use. This is done to prevent the coach batteries from being drained during storage.

Not all loads are disconnected, and, depending on the coach and its options, some systems may have memory circuits purposely not wired to the disconnect solenoid, including, but not limited to, the LP detector (if equipped), driver memory controls, and other memory-based features.

Some switches have a shield on the sides to help prevent accidental battery shutdown when trying to operate the baggage door lock switch.

To operate the battery disconnect:

1. Press up on the rocker switch to turn on the disconnect and reconnect the batteries. This will make the 12 volt system ready for use. When the battery disconnect is turned on, the indicator light will illuminate.
2. Press down on the rocker switch to turn off the battery disconnect and disconnect the batteries. When the battery disconnect is turned off, the indicator light will also turn off.



Battery Inspection, Safety, Care, and Maintenance

This article provides information regarding the inspection, care, and maintenance for coach batteries. Battery maintenance is an important issue often overlooked by many RV owners and technicians. As batteries age, their maintenance requirements change. This means longer charging time and/or higher finish rate (higher amperage at the end of the charge). Usually older, serviceable (unsealed) flooded batteries need to be watered more often, as their capacity decreases over time.

Safety Guidelines

WARNING

Prior to handling or working with a lead-acid battery, consult your battery owners' manual for instructions and safety precautions.

CAUTION

Disconnect the 120 volt electrical power cord and the negative terminal from the coach batteries, and make sure all power sources are disable (ignition, generator, shore power, inverter) before working on the electrical system.

WARNING

Remove rings, metal watch bands, and other metal jewelry before working around batteries. Use caution when using metal tools. If a tool contacts a battery terminal or metal connected to it, a short circuit could occur, which could cause personal injury, explosion, or fire.

Lead-acid batteries contain hydrogen-oxygen gases that may be explosive and sulfuric acid that may cause severe burns. To avoid injury, observe these precautions when handling or working with a lead-acid battery:

- Wear ANSI (American National Standards Institute) approved safety glasses or goggles, as well as a face shield.
- Wear proper clothing to protect your face, hands, and body.
- Work in a well-ventilated area.
- Never lean over a battery while boosting, testing, or charging.
- Keep all ignition sources away from the battery. Cigarettes, flames, or sparks could cause a battery to explode.
- Always shield eyes and face from the battery.
- Do not charge or use booster cables or adjust post connections without proper instructions and training.
- Keep vent caps tight and level.
- In the event of an accident, flush eyes or skin with water, and call a physician immediately.
- Keep out of reach of children.

Common Causes Of Premature Battery Failure

- Deep discharges (leaving your lights on)
- Misapplication
- Replacement using an undersized battery not meeting Newmar's OEM specifications
- Loss of electrolyte due to overheating or overcharging
- Undercharging or loose alternator belt
- Excessive vibration (due to loose clamp or hold down on battery)
- Corrosion
- Freezing (A fully-charged vehicle battery will not freeze until the temperature is -75° F. Frozen batteries are not warrantable.)
- Failure to charge a battery during a period of six months or more (Inactivity can be extremely harmful to all lead acid batteries.)

Cleaning The Batteries

Check the vent plugs and replace them if they are cracked or broken. Keep the battery clean. Accumulations of acid film and dirt may permit current flow between the terminals, which could drain the battery.

To clean, wash the batteries with a diluted solution of baking soda and water to neutralize any acid present. This should be a mixture of a couple of tablespoons of baking soda per pint of water. Rinse thoroughly with clean water. Foaming around the terminals or on top of the battery is a sign that acid is being neutralized. Avoid getting the baking soda solution in the battery. Secure all vent caps.

Both house and chassis battery cable connections need to be cleaned and tightened, as battery problems are often caused by dirty and loose connections. Dry the battery cables and terminals to prevent corrosion. Do not use grease on the bare metal inside the cable terminals. Grease can act as an insulator, and electricity will not flow through it. A plastic ignition spray will protect the terminals after they have been cleaned.

WARNING

Do not allow the battery fluid to contact your skin, eyes, fabric, or painted surfaces. The fluid could cause serious personal injury or property damage. Wear eye protection when working with any battery.

Storing The Batteries

Remember that when batteries are not used for an extended period of time, they may lose their charge. Periodic charging of the batteries during storage of the unit will increase the life of the battery. Check the external condition of the battery periodically. Look for cracks in the cover.

The batteries should be removed and stored in a warm place when not using your motorhome for an extended period of time. This will prevent unnecessary drain and corrosion of the batteries. The coach batteries are 6 volt RV/Marine deep cycle batteries. Mark the cables, positive and negative, for easy identification. Batteries are not to be stored on concrete floors.

Preventing Corrosion

Newmar sprays the battery connections once they are tightened with a battery protector and sealer to help prevent corrosion. When performing battery maintenance, you should reseal the battery terminal connections. The following measures may also prevent future corrosion:

Use a small bead of silicone sealer at the base of the post where it meets the battery case. Place a felt battery washer over the post and into the bead of silicone. Coat the washer with high temperature grease or petroleum jelly (Vaseline), then place the cable on the post and tighten. Coat the exposed cable end with the grease. The gas condensation on metal parts of the battery cause most corrosion issues.

Checking The Fluid Level and Adding Fluid

A serviceable battery needs to have the fluid level checked, as they consume water and must be filled periodically. Please be sure to check the battery water level on a regular basis.

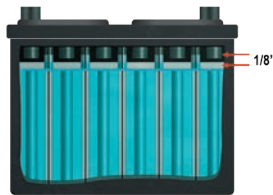

Battery Replacement

This article provides information about how and when to replace coach batteries.

Replacement batteries should be the same brand and capacity as the originals. Any time one battery is replaced, it is important to test the rest of the batteries in the system to make sure they are still functioning properly and efficiently. If one defective battery is replaced, while leaving another weak or defective battery, lowered performance, or ultimately damaging the new or good batteries, may result.

⚠ IMPORTANT

Charging batteries release gasses as the fluids inside boil, so it is critical to check the battery fluid levels regularly, particularly after extended periods of heavy use. Be sure to top off any battery that is showing signs of depleted fluid levels.

A battery wiring label is located inside of the battery compartment and shows how the batteries are wired together. Replacement batteries must be wired according to the diagram shown.

⚠ CAUTION

Use only distilled water to fill flooded / liquid lead acid batteries. Non-serviceable (AGM, Gel Cell) batteries do NOT require the addition of ANY liquid. Adding liquid to non-serviceable AGM or Gel Cell batteries will result in damage to the batteries and will not be covered under warranty.

1. A serviceable battery needs to have the fluid level checked. AGM batteries do not require additional fluid. If the battery has removable vent caps, they can be twisted or pried off with a flat-head screwdriver. Once removed, the individual vent wells can be seen. Look down into each individual cell to make sure that the water is covering the lead plates and is at the proper level.
2. Add water to any cells that are low on water. Ideally, the water level should be 1/8" below the bottom of the tubes (there are six tubes in a 12 Volt battery) that go down into the battery. To avoid damage to the battery, make sure the fluid level never drops below the tops of the lead plates in each of the cells. Always use distilled water to fill the battery to prevent battery contamination.
3. Do not overfill battery cells. Adding too much water may result in acid overflow and damage around the battery. In addition, warmer weather may cause natural fluid expansion, forcing excess electrolytes from the battery.

On diesel coaches, the house batteries are normally located in one of the lower compartments. The chassis batteries are normally on the passenger side in the rear compartment on diesel pushers and under the driver's side cab on the front engine on Super C coaches.

On coaches built on a Ford chassis, batteries are normally located in the front of the coach and can be accessed by opening the hood.

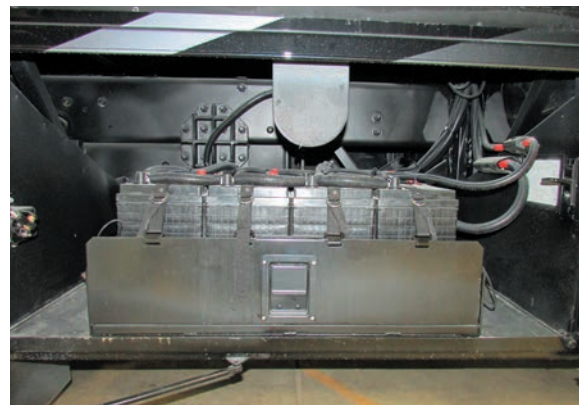



Cord Reels

This article provides an operational overview of the shore power cord reel and switch.

Cord reels (when equipped) provide the ease and convenience of storing the shore power electrical cord in a neat and compact space with the assistance of motorized retraction. On coaches equipped with a power cord reel, pull out the power cord, and plug it into an appropriately rated electrical outlet. Make sure the power source is providing the correct voltage before plugging in the shore cord.

To store the cord, disconnect it from the power source outlet. Remove the cord from the pocket in the compartment, and press and hold the momentary switch to retract and roll up the power cord as needed. The switch is typically located on the cord reel or on the compartment door.

TRC Shoreline Power Cord Reel Operation (Model: RH5)

This article provides brief operation instructions for a TRC Shoreline Power Cord Reel (Model: RH5)

This unit is designed with a clutch type drive to allow direct engagement during retract and clutch disengagement to allow for free spooling during release. These features are controlled using the rocker switch assembly MH2021, RV2100, or equivalent previously installed.

To correctly operate the unit, follow the steps listed below. If the unit does not perform according to the instructions below, first recheck wiring for any issues

Cord Operation

Use only approved applicable outlets. Cord connector has a built-in Easy-T-Pull handle for easy disconnect.

User Maintenance

This unit does not have any user serviceable parts. The user can perform periodic inspection of the cord to insure it is still in usable condition. DO NOT use if the cord is damaged.



Motor Operation

1. Ensure power is being supplied by the 12 VDC source.
2. Locate the switch installed. If using Southwire switches, identify the label markings “RETRACT” located at the top switch position and “RELEASE” located at the bottom switch position.
3. To retract the cord back onto the reel, press and hold the switch in the top “RETRACT” position until the desired amount of cord is returned to the reel.
4. To release the cord from the reel, press the switch MOMENTARILY in the bottom “RELEASE” position. This unlocks the spool and allows for the cord to be manually pulled to a desired length. DO NOT attempt to pull cord from the reel without first pressing the switch momentarily in the bottom “RELEASE” position. Only a MOMENTARY press of the switch in the “RELEASE” position will be needed. DO NOT attempt to continuously hold the “RELEASE” switch position, doing so will cause the cord to unravel on the spool.

Source(s): Southwire Shoreline Reels Operation Instructions Model #RH5

Product(s): TRC 50 Amp 34' Power Cord Reel w/Pigtail (Model: RH54331RM, Newmar Part Number: 132025)



Energy Management Systems

This article provides an overview of the energy management systems used by Newmar.

The energy management and auto generator start systems work behind the scenes to monitor the power supply and demand within the coach. The system is designed to minimize the occurrence of tripped breakers for shore power and the generator while heavy loads are being used. The system turns off other loads temporarily while heavier loads are in use and restores power when heavy loads are turned back off.

When 50 amp service is available, no action is required; however, 30 amp service (or less) requires setting the value of incoming power to be selected.

Auto generator features may vary by coach model and options. Most AGS systems start the generator if shore power is unavailable and the HVAC system signals for air conditioner operation. Many systems will also start automatically if battery levels reach the preset values.

NOTICE

Whenever possible, connect coaches equipped with 50 amp shore power cord to 50 amp service, and connect coaches with 30 amp shore power cords to 30 amp service accordingly. It is the best practice to avoid using adapters and cheater cord devices.

For more information about the energy management system, refer to the SilverLeaf Coach Management or Precision Circuits Power Control System documentation found in Newgle, depending on which system is installed in the coach.

Precision Circuits Midi-Power Control System Monitor Panel Operation

(Models: 00-10050-550, 00-10050-552, 00-10050-553)

This article provides an operational overview of the Precision Circuit Midi-Power Control System Monitor Panel (Models: 00-10050-550, 00-10050-552, 00-10050-553).

Overview

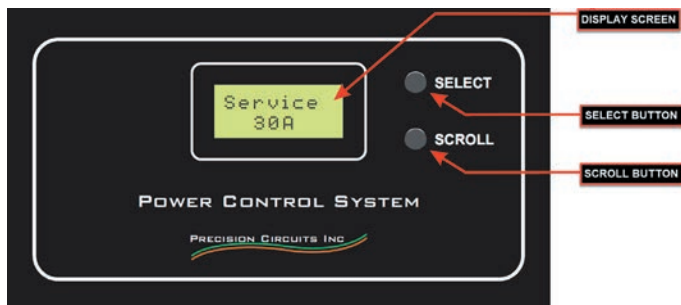

The display is there to help the RV user understand power management and the function of the Midi-PCS. The Midi-PCS monitors the total AC current of an RV and prevents circuit breaker tripping by momentarily shedding up to five loads. As the user turns on additional appliances (such as a microwave, coffee pot, or hair dryer), the Midi-PCS can shed the loads that it controls, (such as the water heater & air conditioner). As the user's selected appliances are turned off, and a minimum of 2 minutes has expired, the Midi-PCS will automatically turn power back on each of the shed loads in reverse sequence.

The Midi-PCS will constantly monitor 120VAC RV power and shed and restore power to the five controlled loads. The display panel has all the brains, a data connector to the I/O module, and an additional connector to control the air conditioners through low voltage signals. The I/O Module houses a current sensor, two relays to control 120VAC powered appliances, and Service Type detect circuitry.

As the Scroll Button is pressed, different information will become available on the Display Screen.

Service Type

One of several options will be displayed indicating the power available to the RV.

- **Service None:** When the RV is not receiving any external power the Display Screen will indicate that there is no service.

- **Service 50A:** Midi-PCS automatically senses 240VAC between L1 and L2 to determine this mode of operation. It assumes enough power is available, turns on power to all appliances, and does not perform any energy management functions.
- **Service 30A:** Midi-PCS automatically senses 0VAC between L1 and L2, and 120VAC between L1 and Neutral, to determine 30A Service. The I/O Module has a current sensor which monitors total RV current. When the current exceeds the 30-amp limit, the Midi-PCS will limit current by shedding appliances that it controls. Once the RV current has dropped, the procedure will be reversed and power will be restored to the shed appliance.
- **Service 20A / Service 15A:** Midi-PCS automatically senses 0VAC between L1 and L2, and 120VAC between L1 and Neutral, to determine 30A Service. The I/O Module has a current sensor which monitors total RV current. When the current exceeds the 30-amp limit, the Midi-PCS will limit current by shedding appliances that it controls. Once the RV current has dropped, the procedure will be reversed and power will be restored to the shed appliance.
- **Generatr 45A:** Midi-PCS senses the Generator Hour Meter signal to know the Generator is running. When the generator first starts, Midi-PCS performs a soft start, shedding all the appliances, and turning them back on one at a time, after a 2-minute delay. The Midi-PCS operates the same as above, except the current limit is adjusted to match the size of Generator.

Load Status

After Service Type, pressing Scroll Button will scroll through all the appliances Midi-PCS controls.

- **WaterHtr Powered:** Midi-PCS controls up to 5 appliances or loads. This is an example of one of the appliances the Midi-PCS may shed, should it sense over-current. The user can press SCROLL to view all of the appliances the Midi-PCS controls. If the RV is not trying to use too much current, then the load will have power available and displayed as such. Note: this does not mean the appliance is on, just that power is available.

- **WaterHtr Shed:** If Midi-PCS has sensed an over-current condition, for example the Microwave has been turned on, it will shed power to the first appliance in the list, and display as such. As the user turns on more appliances, such as a hair dryer, the Midi-PCS will continue down the list shedding power to the next appliance on the list. When the user turns off the hair dryer, Midi-PCS will sense available power and begin to restore appliances in reverse order (First off, will be last back on.)

While on any of the Load Status screens, if the Select button is pressed, an overall status of all the Loads can be seen. There are three options:

1. **Waiting Amps > Max** means that turning the next appliance back on would cause the Amps that the RV is drawing to go over the Max allowed for the Service Type. (30A = 30 amps Max)
2. **Waiting 120 Secs: #1** condition above does not exist, turning on the next appliance would be OK. However, if any appliance is shed, then a minimum of 2 minutes or 120 secs must pass before power is restored. This is required for things like A/C compressor pressure to decrease. The user can then watch a countdown, in seconds, of when power will be restored. When the countdown concludes, the screen below will appear.
3. **No Loads Shed:** This lets the user know that all Midi-PCS controlled appliances are running.

Diagnostics

While on any of the Load Status Screens, pressing and holding Select button provides Learned Load current.

- **WaterHtr Shed = 10A:** Midi-PCS displays Learned current for a specific appliance. This is the current the appliance was drawing when Midi-PCS shed its power. If the appliance happened to be off, Midi-PCS will learn and display Shed= 0A. This display of current is not live and only a picture in time, at the instant the appliance was shed. Midi-PCS uses this value to determine when it is safe to restore power to this appliance. Displaying Amps>Max above means restoring the Learned current would put the RV over the Service Type Max limit, and Midi-PCS is Waiting for another appliance to be turned off.

- **WaterHtr Not Shed: Not Shed,** is displayed when power to the appliance is available, and no recent Learned current is available to display. Viewing the current on the Amp Display below when is goes above the Service Type Max and then again when a Load is Shed, is how the Learned current above is calculated.

Amps Display

After scrolling thru each Load Status the next press of the Scroll button will display RV current.

- **Amps = 25A:** Midi-PCS displays total RV 120VAC amps or current being drawn by the entire RV, including Midi-PCS controlled appliances, other RV appliances, and appliances plugged into any outlet of the RV. This current is live, constantly monitored and updated. If RV current goes above the max limit for the Service type, it can be seen here for about a second before Midi-PCS begins to shed appliances.
- The good news is the user needs very little interaction with the Midi-PCS. It sheds loads and restores power all by itself. The user no longer has to do manual energy management of the RV, but can relax and let the Midi-PCS do its job. The only time the user needs to perform a function with the Midi-PCS is after plugging the RV into a 20A or 15A receptacle, since the Midi-PCS can not sense these two Service types automatically.

Source(s): Precision Circuits Midi-Power Control System Owner's Manual (RevB)

Product(s): This source is associated with more than one product. Refer to Newgle for more information about the product(s) offered for your coach's model year.

Precision Circuits Power Control System Monitor Panel Operation (Model: 00-10019-050)

This article provides basic operation instructions for a Precision Circuits Power Control System Monitor Panel (Model: 00-10019-050).

Monitor Panel

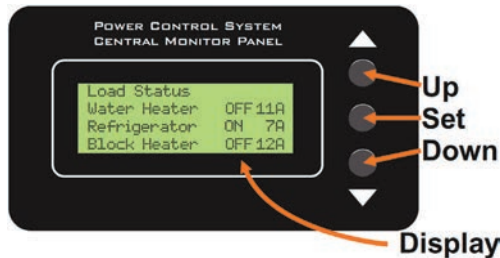

The PCS Monitor displays pertinent Power Control System status information. The UP and DOWN buttons are used to step through each individual Screen of information. Pressing & releasing either the UP or Down button will step to either the Previous or Next Display Screen. Once all the Screens have been seen, the next press of the Button will wrap back around through all the Display Screens once again. The SET Button only functions when the Service Type screen is displayed, to Select between 30A Service and 20A Service.

(Note: 50A Service or Generator Service overrides the SET Button.) If there have not been any key presses for awhile, the PCS monitor turns off the backlighting to save on power. The first press of any key will only turn on the back lighting.

Service Type

- No Service: PCS has 12V Battery power to run the electronics, however, it does not sense any 120/240VAC Power.
- 50-amp Service: PCS senses 240/208VAC between L1 and L2 to determine this mode of operation. PCS controls the loads so that the current does not exceed L1 limit of 50amps, L2 limit of 50amps, and a combined limit of 100 amps.
- 30-amp Service: PCS senses 0VAC between L1 and L2. PCS adds the current of the two sensors and controls the loads so that the current does not exceed 30 amps.
- 20-amp Service: PCS senses 0VAC between L1 and L2, and the owner selects 20A on the Central Monitor Panel. PCS adds the current of the two sensors and controls the loads so that the current does not exceed 20 amps.
- Generator: PCS senses power to the Gen Hour Meter to determine this mode of operation. PCS controls the loads so that the current does not exceed the ratings of the installed Generator, for example L1 limit of 35amps, L2 limit of 35amps, and a combined Limit of 63 amps.

Operation Mode

This Screen gives the general information about Load Status.

The First Line shows the Status of the Magnum Battery Charger. It will either be: Bat Charge Normal, under complete Magnum Control, or Bat Charge Reduced, which means an Owner activated appliance would have caused a circuit breaker to trip but instead the Bat Charger Rate has been reduced. Reducing the Battery will be the 1st thing that PCS will attempt in order to reduce overall RV Power. Battery Charge may not be reduced if the Battery is Low, or the Magnum Inverter is on Line 1 Circuit Breaker and the Overload is on Line 2 only.

- The Second Line show the Status of the Magnum Inverter. It will either show Inverter Normal, under complete Magnum Control.
- Inverter Assist, PCS is requesting that the Magnum Inverter assist by temporarily generating 120VAC power from the batteries.
- Inverter Assist 12A, the end of this line shows the amount of 120VAC current that the Inverter is supplying.
- Inverter Assist Deny, means the Magnum Inverter can not Assist at this time, for one of many Magnum Inverter reasons, i.e. Battery Low, Over-current, etc. (See Magnum Owner's Manual).
- The Last Line shows if any Loads have been Shed to prevent circuit breaker tripping. Load(s) Shed = 7, depending on the model RV, there can be up to 7 Loads that PCS can control.

Line Status

PCS not only monitors total RV current but also has two built in Volt Meters, and monitors the voltage on each of the Lines.

L1 121Volts 15Amps, indicates that Line 1 has 121 Voltsrms and is presently drawing 15 amps.

! Brown Out !, if the display indicates Brown Out, the Display will hold the lowest captured voltage that may have occurred while the RV owner is away. Pressing any switch clears the display, and resumes displaying the present readings.

Wiring Status

Similar to an Outlet Tester that is plugged into outlets in your home to test for proper wiring, PCS monitors the wiring status of the Camp Ground Outlets you may plug into.

WARNING, IF THE DISPLAY EVER INDICATES “Wiring Status Error,” IMMEDIATELY, unplug the RV from the outlet, and have the outlet inspected by a qualified technician.

The other lines on the Display to the right indicate proper wiring for 50A Service. For 30A Service L1=L2.

Power Management

When the current exceeds the limit, because possibly the owner has turned on the Microwave, the PCS will independently limit the current on each line by performing the following in order: Reduce Magnum Battery Charge Rate, Inverter Assist, Load Shed. (If the Magnum Inverter is wired to the opposite leg, only Load Shedding will occur.

As each appliance is shed, PCS learns the current for that specific appliance, to ensure that there will be sufficient headroom to turn the appliance back on and be under the current limit. To ensure that Air Conditioner compressor pressure is bled, and to reduce quick cycling, there is a 2 minute delay from the time a Load has been shed, to the time power is restored.

Once the total RV current has dropped, for example because an owner operated appliance has been turned off, the PCS will reverse the above procedure, returning power to appliances whose operation was not immediately critical.

Load Status

Where the last Screen gave general information about all the controlled Loads, these next two screens gives detailed information about the status of each Load under PCS control.

Water Heater OFF 11A, indicates that the Water Heater power has been temporarily turned OFF, and the current at the instant the Water Heater was turned off last was 11 amps.

Refrigerator ON 7A, indicates that the Refrigerator has power. Again the 7amps of current is NOT the present current draw, but rather the current at the instant the Refrigerator was turned off last. A/C #2 ON, indicates that the A/C #2 has power. Since there is no current displayed, that only indicates that this load has not been turned OFF even once since the Battery has been reconnected and 12V power applied to PCS. PCS has never had a chance to “Learn” the current. The Current Displayed, is re-learned each and every time that the Load is turned OFF.

Looking at the list, it appears that PCS does not turn off Loads in Order Preference. PCS will always start shedding loads from the top of the list when PCS in 30A or 20A Service. However, in 50A Service, or running on the Generator there are two Main Breaker, Line 1 & Line 2. PCS will only shed loads if there is an overload detected on its associated Line. In other words, if shedding the Load will not help, skip it and move on. If then sometime in the future an overload is detected on the other Line, PCS will start at the top of the list again. The same is true with Magnum Battery Charge Reduction and Inverter Assist. Magnum can only help on the Line it is wired to, so if it will not help to Assist, don't bother.

Source(s): Precision Circuits Power Control System 50A (Rev052207)

Product(s): Precision Circuit Energy Management System Remote Display (Model: 00-10019-050, Newmar Part Number: 127558)

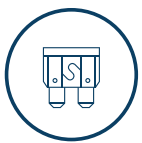

Fuse Panels

This article provides information and the location of the house and chassis fuse panels.

Fuse Panels on Coaches Built on Ford Chassis

Inside The Coach

On a class A coach, the house fuse panel, which controls most of the components and appliances inside the coach, is located in the bathroom. This panel contains fuses and breakers that are connected to all main appliances in the coach, from the refrigerator and television to the lights in the bedroom and slideouts.

There are also some external components that are fused in the house fuse panel. For example, the fuses for the water pump, water heater, awning, and basement storage lights may be located in this panel.

The Ford chassis fuse panel is located on the sidewall, left of the driver's feet. This fuse panel supplies power to exterior lights, the tow plug, and the wipers. For exact details, see the Ford manual.

To access the Ford fuse panel on the passenger side under the dash, rotate the clips on the sides of the cover to release and remove the cover. To remove the black fuse retainer, pinch the two tabs together, and pull out on the retainer to gain access to the fuses. To replace the cover when finished, install the retainer by aligning and pressing in until the fuse retainer snaps in place. Install the cover, and rotate the retainer clips to hold the cover in place.

⚠ NOTICE

On Canyon Star 3911 models (handicap accessible units), this panel is located on the back wall of the bedroom, next to the 120 volt breaker panel.

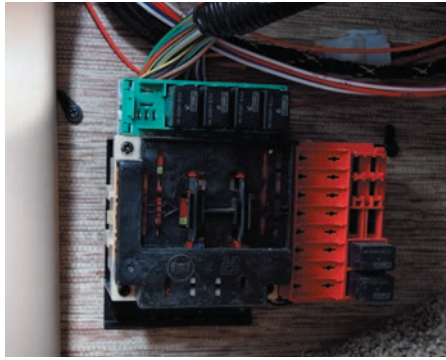

Ford Chassis Fuse Panel Example

Outside The Coach

House battery and disconnect fuses are located under the hood of the coach. These fuses control the battery boost, battery disconnect, and entrance steps. In this same location, there are also 12 volt circuit breakers that provide power to the ignition, house fuse panel, inverter, and the power seats (if equipped).



House Fuse Panel Example

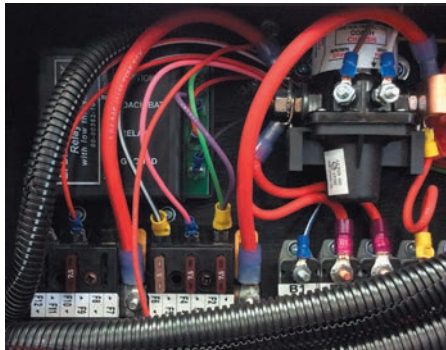

Generators

This article provides information for maintenance, operation, and safety for gas and diesel generators.

Generator and GenStart/Stop Switch Overview for Gas Coaches

This article provides basic operation instructions for a generator and GenStart/GenStop switch on a gas coach.

The generator is wired into the Automatic Transfer Switch and will power all of the 120 volt circuits in your coach. Your generator may be located in a side compartment or in the front of the coach in between the frame rails of the chassis. Some generators are mounted on slides for easy access and may need to be unlocked before free movement is allowed. The main breakers for the output legs are located on the generator start panel.



The generator in your coach runs on the same fuel as your main engine. The fuel is drawn through a separate supply tube that is positioned in the tank in a manner that will not allow the generator to draw fuel and run if the tank level dips below the ¼ level.

PRIOR TO STARTING THE GENERATOR:

- Before starting the generator, turn off all air conditioners and large electrical loads.
- Before starting the generator in cold weather, turn off all appliances to maintain peak performance.
- Prime the generator by holding down the STOP button.

TO START THE GENERATOR:

- Press and hold the START button on the control panel or at the generator. The indicator light will flash as the generator is cranking and remain illuminated once the generator is running. Release switch after generator has started. - If generator is not starting, Do not over-crank.
- Before turning on appliances, let the generator warm up for a few minutes.

Operating The Generator

The generator can be started from the rocker switch on the dash, from other remote start switches (if equipped), or from the start switch on the generator itself.



TO STOP THE GENERATOR:



- Turn off all air conditioners and large electrical load.
- Allow the generator to run for three to five minutes to allow the generator to cool down.
- Press the rocker switch to the STOP position, and release it. The generator will stop running, and the indicator light will turn off.

IMPORTANT

Excessive cranking can damage the starter motor. Do not crank the generator more than 30 seconds at a time, and allow at least two minutes before trying again if the first attempt fails.

CAUTION

Failure to turn off the 120 volt appliances when starting or stopping the generator may damage the transfer switch and/or electrical appliances.

 DANGER	 DANGER
<p>Vehicles and equipment powered by internal combustion engines and placed in recreational vehicles can cause carbon monoxide poisoning or asphyxiation, which could result in death or serious injury.</p> <p>The flammable liquids used to power these items can cause a fire or explosion, which can result in death or serious injury.</p> <p>To reduce risk:</p> <p>a) Do not ride in the vehicle storage area when vehicles are present.</p> <p>b) Do not sleep in the vehicle storage area when vehicles are present.</p> <p>c) Close doors and windows in walls of separation (if installed) when any vehicle is present.</p> <p>d) Run fuel out of engines of stored vehicles after shutting off fuel at the tank.</p> <p>e) Do not store, transport, or dispense fuel inside this vehicle.</p> <p>f) Open the windows, openings, or air ventilation systems provided for venting the transportation area when vehicles are present.</p> <p>g) Do not operate propane appliances, pilot lights, or electrical equipment when motorized vehicles are present.</p>	<p>Les véhicules et l'équipement propulsés par un moteur à combustion interne placé dans un véhicule de camping peuvent causer un empoisonnement au monoxyde de carbone ou l'asphyxie, ce qui pourrait entraîner des blessures graves ou la mort.</p> <p>Les liquides inflammables utilisés pour propulser ces machines peuvent causer un incendie ou une explosion, ce qui peut entraîner des blessures graves ou la mort.</p> <p>Pour réduire le risque:</p> <p>a) Ne pas circuler dans l'aire de rangement du véhicule si des véhicules s'y trouvent.</p> <p>b) Ne pas dormir dans l'aire de rangement du véhicule si des véhicules s'y trouvent.</p> <p>c) Fermer les portes et fenêtres qui se trouvent dans les cloisons (le cas échéant) si au moins un véhicule est entreposé.</p> <p>d) Épuiser le carburant contenu dans les moteurs des véhicules entreposés après avoir coupé l'alimentation en carburant au réservoir.</p> <p>e) Ne pas entreposer, transporter ou distribuer de carburant à l'intérieur de ce véhicule.</p> <p>f) Ouvrir les fenêtres, ouvertures ou systèmes de ventilation d'air fournis pour ventiler la zone de transport lorsque des véhicules s'y trouvent.</p> <p>g) Ne pas faire fonctionner d'appareils au propane, de veilleuses ou d'équipement électrique en présence de véhicules motorisés.</p>

Generator Maintenance

Before starting your generator for the first time each day, and subsequently after each eight-hour run cycle, perform the following checks to make sure it is ready to be used.

1. Make sure the carbon monoxide detectors in your unit are working.
2. Check for signs of fuel or exhaust leaks.
3. Make sure there is adequate clearance around the generator for proper ventilation. Also check for sloping ground or any other obstructions that may have occurred. Tall grass or other items that come in contact with the generator may interfere with ventilation or cause a fire.
4. Check the oil and coolant levels, and inspect for leaks.
5. Check the battery connections to make sure they are tight and clear of corrosion.
6. Inspect the generator inside compartment for road debris or damage that might affect the performance or safety.
7. Turn off major appliances (such as air conditioners, televisions, and other electronics that may excessively load the generator or may be sensitive to initial voltage surges).

The hour meter installed on the generator calculates the number of running hours of the generator motor. This is used for maintenance schedules. Regular oil changes and other maintenance performed at the prescribed intervals will greatly extend the life of your generator.



Inverters and Converters

Provides basic information about the role and operation of inverters, converters, and inverter/converter combination units.

Inverters

The inverter modifies direct current to alternating current to provide power to specified appliances and entertainment systems. The inverter performs this action by using a transformer to increase the voltage and modify the higher voltage into a useable alternating current power. For this function to occur, the inverter must be powered, set up, and turned on. A variety of inverters are used by Newmar; however, most have a control panel located in the overhead cabinet with other switches and controls.

Converters

A converter transforms alternating current or shore line power 120 volts; to low-voltage direct current to provide power to the coach's 12 volt house and chassis batteries. This function occurs automatically when 120 volts are supplied to the converter. Converters are usually located in the cord compartment of coaches that do not have a inverter/converter combination unit.

Inverter/Converter Combination Units

The inverter/converter combination provides battery charging and allows the 120 volt power from shore power or the generator to pass through the inverter. The inverter performs this charging action by using the transformer to decrease the voltage and rectify the alternating current into useable direct current voltage. This is regulated by internal-sensing circuitry based upon the battery bank's state of charge and several other factors, depending on the coach's particular inverter brand and type.

This type of unit also performs the inverter function. For this function to occur, the inverter must be powered, setup and turned on. A variety of combination units are used by Newmar; however, most have a control panel located in the overhead cabinet with other switches and controls.

Progressive Dynamics Intelli-Power Converter Operation (Models: PD9100 and PD9200 Series)

This article provides basic operation instructions for a Progressive Dynamics Intelli-Power Converter (Models: PD9100 and PD9200 Series).

General Operation

The INTELI-POWER series converter will supply "clean" power from input voltages that range from 90-130 VAC.

The INTELI-POWER series of converters are primarily designed for use with a battery, however, the output of the INTELI-POWER converters are a regulated, filtered DC voltage that can power sensitive electronics without the need for a battery or other filtering.

At normal input voltages the full load rated capacity is available. At input voltages less than 105 VAC the converter may not supply full rated output capacity.

9100

The full rated load is available for load, battery charging or both. When functioning as a regulated battery charger the converter has a nominal voltage output of 13.6 VDC for 12 volt models. The system is designed to sense voltage on the battery and will taper the charging current as the battery becomes charged.

When the vehicle is to be stored for extended periods of time it is recommended that the batteries be disconnected, unless a TCMS Charge Wizard is attached to the TCMS interface. Reconnect battery once a month to maintain a full charge.

9200

The full rated load is available for load, battery charging or both. When functioning as a regulated battery charger the converter has a nominal voltage output of 13.6 VDC for 12 volt models. The system is designed to sense voltage on the battery and automatically selects one of three operating modes (normal, boost and storage) to provide the correct charge level to the batteries.

BOOST MODE

If the converter senses that the battery voltage has dropped below a preset level the output voltage is increased to approximately 14.4 VDC to rapidly recharge the battery.

NORMAL MODE

Output voltage set at approximately 13.6 VDC.

STORAGE MODE

When the converter senses that there has been no significant battery usage for 30 hours the output voltage is reduced to 13.2 VDC for minimal water usage. When in storage mode the microprocessor automatically increases the output voltage to 14.4 VDC for approximately 15 minutes every 21 hours to help prevent sulfation of the battery plates.

⚠ CAUTION

It is important that the fluid level of any connected batteries be checked on a regular basis. All batteries will "gas" and lose some fluids when continuously connected to any charging source.

TCMS Charge Wizard

Your INTELI-POWER converter is equipped with a TCMS interface. The TCMS Charge Wizard pendant plugs into the TCMS interface to provide computer control and monitoring of your batteries charge state. The Charge Wizard automatically determines which operating mode is best suited to recharge or maintain optimum battery condition. The Charge Wizard Pendant (if equipped) allows for manual override and has an indicator light to indicate the mode of operation.

BOOST MODE

Indicated by green LED remaining on.

NORMAL MODE

When the battery is between 50% and 90% charged, the green LED will flash once per second. When the battery has reached 90% of full charge the green LED will flash 2 - 3 times per second.

STORAGE MODE

Indicated by green LED flashing every 6 - 8 seconds.

MANUAL BUTTON

The manual button has been provided to allow the operator to temporarily override the converter (not recommended) or to verify the converter is operating properly. For manual operation, press and hold the button. The indicator light will soon remain “ON” indicating Boost Mode. Continue to hold the button and the light will blink rapidly indicating the converter is in the Normal Mode. Continue to hold the button until the light blinks slowly indicating the converter is now in the Storage Mode. After the manual button is released the converter will stay in the selected mode. When the battery charge status changes, the converter will return to the automatic mode of operation to prevent damage to the battery.

Source(s): *Inteli-Power PD9100/9200 Series Power Converter Owner's Manual*

Product(s): *Progressive Dynamics 45 Amp Converter w/Built-in Charge Wizard (Model: PD9245C, Newmar Part Number: 118449) and Progressive Dynamics 60 Amp Converter w/Built-in Charge Wizard (Model: PD9260C, Newmar Part Number: 118450)*

Xantrex Freedom X 1200 and 2000 Watt Sine Wave Inverter Operation (Models: XC Series)

This article provides basic operation instructions for a Xantrex Freedom X 1200 and 2000 Watt Sine Wave Inverter (Models: XC Series). Coaches requiring two or more 1200 watt inverters (Newmar option) will automatically be upgraded to a single Xantrex 2000 watt inverter with charger (Model 2080).

LCD Screen or Remote Panel

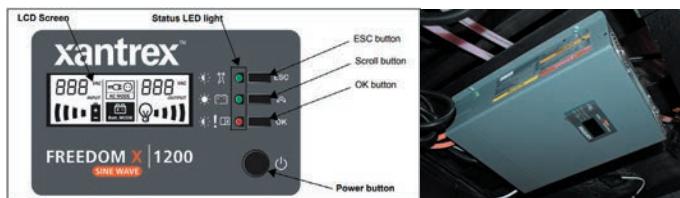

The LCD Screen changes depending on the operating mode of the inverter.

Indicator	Definition
	Indicates AC mode in which shore power is available and passing through to the loads.
	Indicates Battery mode (Inverter mode) in which the inverter is running and supplying power to the loads from the battery.
	Indicates Fault mode and is accompanied by an error code displayed on the LCD screen.
	Indicates a Warning condition and is accompanied by an error code and a sounding alarm.

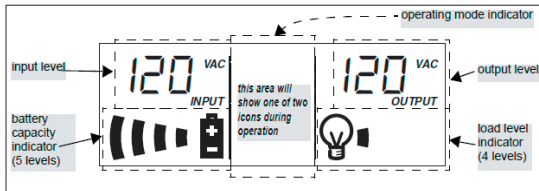

LCD Screen Icons and LED Light Indicators

Icon	Definition
	Appears in all modes. Indicates ~ 75–100% battery capacity.
	Appears in all modes. Indicates ~ 50–75% battery capacity.
	Appears in all modes. Indicates ~ 25–50% battery capacity.
	Appears in all modes. Indicates ~ 1–25% battery capacity.
	Appears in all modes. Indicates 0% battery capacity.
	Appears in AC mode only and sometimes in Fault mode. Indicates ~ 75–100% load capacity.
	Appears in AC mode only and sometimes in Fault mode. Indicates ~ 50–75% load capacity.
	Appears in AC mode only and sometimes in Fault mode. Indicates ~ 25–50% load capacity.
	Appears in AC mode only and sometimes in Fault mode. Indicates ~ 0–25% load capacity.
	Indicates AC mode in which shore power is available and passing through to the loads.
	Indicates Battery mode (Inverter mode) in which the inverter is running and supplying power to the loads from the battery.

AC Mode

AC Mode is when AC shore power is available as input and the power is passing through as output. The display may look similar to this:

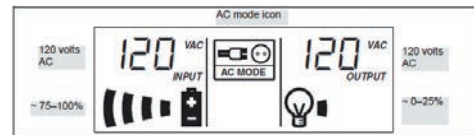

OPERATING IN AC MODE

The Freedom X operates in AC mode when an AC source (a generator or utility power) is present at the AC input terminals. When the AC source is within operating range (meaning the voltage is, the Freedom X unit bypasses inverter mode and powers the appliances connected to the unit. The green status LED lights up to indicate the Freedom X is using utility (or generator) power.

When shore power is present, AC power automatically passes through the Freedom X. Pressing the inverter Power button on the display panel does not interrupt the supply of shore power. AC Mode supersedes inverter operation.

When the Freedom X's inverter Power button is turned ON and the AC source is outside the operating range or is disconnected, the transfer switch automatically switches to Battery Mode.

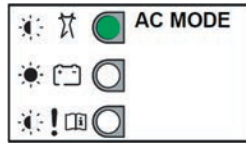

Battery Mode

In Battery Mode (also called Inverter Mode), the AC output power comes from the battery. The LCD Screen switches to displaying battery mode information such as:

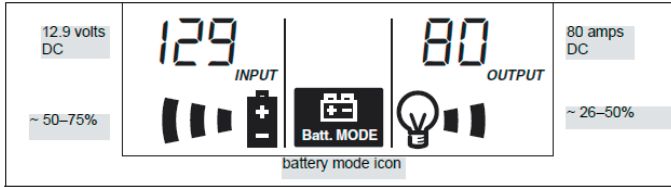

OPERATING IN BATTERY MODE

The Freedom X is in Battery Mode (also called Inverter Mode) when all the following conditions exist:

- inverter power button is ON (down position) or ignition auto-on is activated
- shore power is not presently available
- battery has sufficient power

Inverter operation means that DC battery power is presently being converted to utility grade AC power, powering equipment and appliances connected to the AC output terminal of the unit.

The green status LED lights up to indicate the Freedom X is using the battery to power the equipment and appliances.

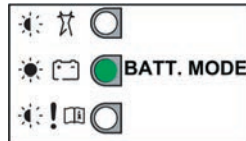

VIEWING INFORMATION DURING BATTERY MODE

The LCD screen displays Inverter information as well as feature settings in coordination with the LED lights alongside the screen.

- Press the Scroll UP button to toggle between the following basic information:

INPUT VOLTAGE/OUTPUT VOLTAGE

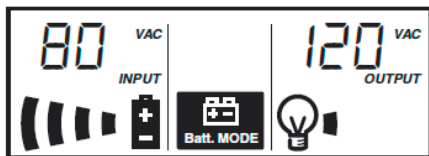

- Default screen
- Shore power voltage = 80V
- Output voltage = 120V

BATTERY VOLTAGE/BATTERY DISCHARGE CURRENT

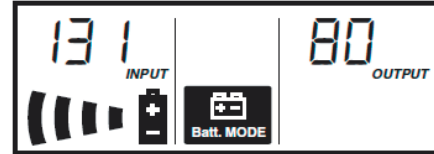

- Battery voltage = 13.1V
- Battery discharge current = 80A

LOAD PERCENT

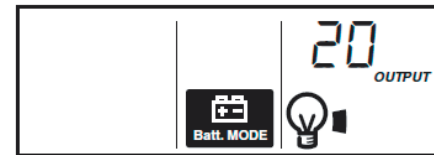

- Load = 20%

WARNING/FAULT

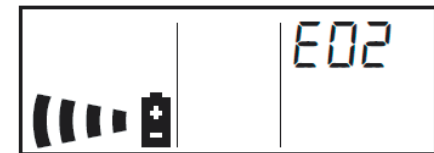

- If a fault or warning is detected, this screen becomes the default screen.
- Error code = E02 "DC Input Over Voltage shutdown"

Idle Mode

When there is no AC output such as when an error or fault condition is detected, the Idle Mode is displayed on the LCD Screen. An example is shown below:

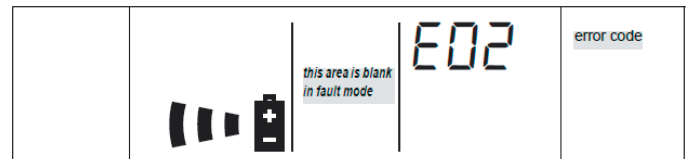

For definitions on battery capacity, load level, and error code indicators, refer to the "LCD Screen Icons" section.

Turning Inverter Operation On and Off

There are two ways to operate the Freedom X's inverter.

- Press the inverter Power button to a down position (it is Off in the up position).
- When the inverter's Ignition Control feature is set to Auto-on, and the Ignition Control switch is enabled and, a +12VDC signal is present.

⚠ WARNING

ELECTRICAL SHOCK HAZARD: Turning the inverter Power button off does not disconnect DC battery power from the Freedom X. You must disconnect both AC and DC power before working on any circuits connected to the unit. Failure to follow these instructions can result in death or serious injury.

To prevent unnecessary battery discharge, press the inverter Power button to turn it off when you are not using the Freedom X.

Checking Battery Status

During inverter operation (in battery mode), you can check the battery status by observing the battery capacity indicator on the LCD screen. The battery voltage appears in the left side of LCD screen. The normal operating battery voltage range is between 11 and 15 volts.

Checking Output Power

When the inverter is in operation (in battery mode), you can check how much power (displayed in Amps) the Freedom X is supplying to the connected loads by observing the load capacity indicator on the LCD screen. The battery discharge amperage appears in the right side of the LCD screen.

Operating Several Loads At Once

If you are going to operate several loads from the Freedom X, turn them on one at a time after you have turned the inverter on. Turning loads on separately helps to ensure that the inverter does not have to deliver the starting current for all the loads at once, and will help prevent an overload shutdown.



Lighting

A Newmar coach's electrical and lighting system is designed for maximum reliability, functionality, and style.

Interior and Exterior Lights

Provides basic information about operation, maintenance, and replacement of interior and exterior lights.

Interior Lights

A Newmar coach's electrical and lighting system is designed for maximum reliability, functionality, and style. Your coach may feature traditional on/off switches or multi-switch touch panel light and accessory switch panels. Located throughout the unit, these switching devices are used to turn lights on and off, as well as to operate power shades and window treatments. Many coach models boast LED accent lights and LED wall sconces custom-designed for Newmar.

Turning The Audible Alarm On or Off

The Freedom X's audible alarm can be silenced. Any warnings such as fault conditions or imminent shutdown are both displayed on the LCD screen and sounded on the alarm speakers. It is not possible to turn OFF the screen and prevent it from displaying error codes but it is possible to turn OFF the audible alarm.

To reset the alarm:

- Press the inverter Power button to turn it Off (from a down position to up) and press again to turn it On to reset an active alarm and clear the fault.

Resetting AC Output

The 15 amp resettable breaker is located on the inverter near the outlet.

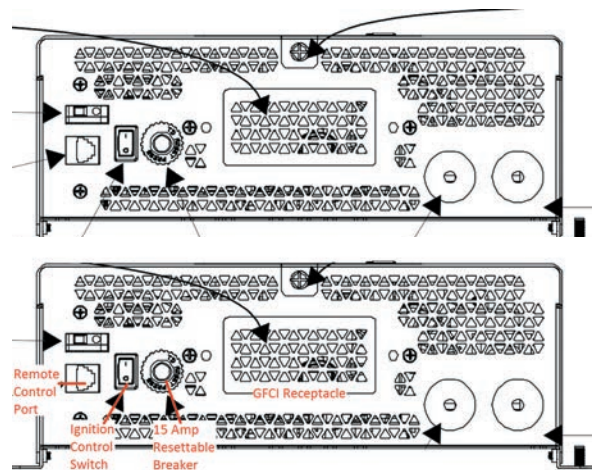

Source(s): Xantrex Freedom XC Series Inverter Charger Owner's Guide

Product(s): Xantrex 1200 watt Pure Sine Freedom Inverter (Model: 806-1212, Newmar Part Number: 144620) and Xantrex True Sine 2000 Watt Inverter (Model: 817-2080, Newmar Part Number: 145171)

⚠ IMPORTANT

When replacing halogen bulbs, do not touch the bulb, as the oil from your hands will reduce the bulb's life.

Many of these bulbs are made as both filament and LED. Most LED bulbs are polarity-sensitive unlike filament bulbs. When attempting to replace filament-type bulbs with LED-type bulbs, it is possible for the light fixture to be wired in reverse polarity for the LED replacement bulbs. Switching to a different type of bulb may require a wiring change. Newmar recommends any wiring modifications be performed by an authorized service technician.

Turn off the lights to avoid possible short circuits, blown fuses, and burns while removing and replacing bulbs or lights. Depending on the year and model of your coach, it may be equipped with LED light fixtures with the lights embedded into the light housing.

Many of the LED light fixtures have integrated LED assemblies that are non-serviceable and non-replaceable. When LED light bulbs burn out in this type of fixture, the complete light must be replaced. Replacement bulbs or light fixtures are available for purchase through the Newmar Parts Department.

⚠ WARNING

Do not substitute bulbs just because they will fit, as it may cause overheating, back feed, or damage to the light fixture or lens.

Exterior Lights

Replace any exterior light bulbs or fixtures as needed to maintain DOT safety requirements. When servicing interior or exterior lights, make sure you replace any light bulb with the same bulb number (normally stamped on the base of the bulb or printed on the bulb). Replacing the bulb with the identical part number will ensure the wattage and base are the same.

The coach may have headlights installed that are atmospherically vented, so condensation may occur in these headlight assemblies. Under normal driving conditions with the headlights turned on, the condensation will dissipate, allowing it to escape through the vent.

⚠ IMPORTANT

Always check the operation of all headlights, turn signals, and clearance lights prior to traveling.

It is necessary to keep exterior lights clean, as dirty lights have diminished output and reduced visibility. To clean your exterior lights, use a mild soap designed for automotive car washing. Avoid using harsh cleaners, abrasive products, and petroleum-based products or other chemicals.

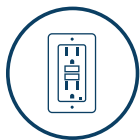

Receptacles and Accessory Chargers

Newmar coaches are framed 16 inches on center, allowing the best placement of outlets, switches and other components.

120 Volt Outlets

This article provides information about the 120 Volt outlets located throughout the interior of the coach.

Several 120 volt receptacles are located throughout the interior of the unit. These receptacles require three-pin plugs that provide proper grounding to protect you from electrical shock. The breaker for the outlets are usually located in the breaker box. If the breakers are on the inverted circuitry, they will be located in the subpanel near the main breaker box.



⚠ IMPORTANT

Do not use an adapter, cheater, or extension cord that breaks the continuity of the ground circuit to the ground pin. Never remove the ground pin from a plug in order to connect it to a two-pronged ungrounded outlet.

Ground Fault Circuit Interrupt Outlets (GFCI)

This article provides an overview of the purpose and function of a GFCI outlet.

The Ground Fault Circuit Interrupt (GFCI) outlets protect the user from ground faults between a hot wire and ground. The 120 Volt electrical outlets in the kitchen and bath area are GFCI protected receptacles. The electrical outlets located in the slideouts are wired through the kitchen GFCI.



The exterior electrical outlets are wired through the bathroom GFCI. On units equipped with the floor heat option, a separate GFCI is installed in the bathroom or near the main breaker box. Units with the holding tank heat pad option will have an additional GFCI located in the basement area; however, the exact location varies.

Testing The GFCI Outlets

The GFCI outlets should be tested at least once a month. The reset button needs to be pressed before starting the test.

1. The GFCI outlet must be supplied with 120V power for testing and general use.
2. Pressing the Test button on the GFCI outlet will trip and cease to supply power to the outlets on the GFCI, as well as any other outlets that are hooked up downstream of the GFCI outlet.
3. Pressing the Reset button will reset the GFCI outlet and all outlets downstream of the outlet. Some GFCI outlets may have a LED light as a visual indicator of the power status.
4. If a tripped GFCI outlet will not reset, disconnect everything plugged into them or hooked up downstream; then try resetting the GFCI again.

5. If all loads are disconnected and 120V power is present to the GFCI outlet and the GFCI outlet will still not reset, it may require service or replacement by a qualified technician.

If the GFCI is working properly, the reset button will remain in the “IN” position. If an item plugged into a slideout or outside receptacle is not working, check for a tripped GFCI in the kitchen or bathroom. Likewise, if the floor heat or holding tank heat pads are not working, check the GFCI for that circuit.

WARNING

The GFCI will not reduce the shock hazard if the short is between a neutral and hot wire or two hot load wires.

USB Outlet, Auxiliary Input, and 12 Volt Receptacle Overview

This article provides a functional overview of the USB outlet, auxiliary input, and 12 volt receptacles in a coach.

USB Outlets

USB outlets may be located in various places throughout the coach. The number of ports may vary. The USB outlets are for charging only and are not connected to any entertainment equipment. They simply provide convenient accessory charging without filling your 120 volt outlets with chargers. Most USB outlets require 120 volt power when located outside of the cockpit area of the coach.



12 Volt Receptacles

Your coach maybe equipped with one or more 12 volt receptacles conveniently located in the dash area. These 12 volt receptacles allow you to plug in a variety of 12 volt DC accessories, including cell phone battery chargers, camera battery chargers, etc. These are fused at 20 amps.



Auxiliary Inputs

USB ports labeled with auxiliary input are normally connected to the dash radio and allow input to the radio via USB and or 3.5 mm cable. Refer to the owner’s guide for the radio for information about selecting auxiliary inputs.





Solar Power

This article provides basic information about the solar panels that may be installed on the coach.

Solar Power Overview

If your coach is equipped with a 5 or 10 watt solar panel, it charges the chassis batteries when exposed to sunlight. Larger solar panels (optional equipment on select coaches) may also charge the house battery bank.

The solar panel is regulated to charge automatically and should be cleaned as needed for the most efficient light absorption. The following is an example of how the system may charge the batteries based on battery voltage. For example, if the chassis batteries are above 12.7 volts direct current, the solar panel may provide less charge.

- 12.7 Volts = 100% of Battery Charge
- 12.4 Volts = 75% of Battery Charge
- 12.2 Volts = 50% of Battery Charge
- 12.0 Volts = 25% of Battery Charge
- 11.9 Volts = 0% of Battery Charge

⚠ IMPORTANT

It is important to note that the system may not indicate a charge any time it is exposed to sunlight. The built-in “regulator” will only allow the system to charge the chassis batteries when their voltage is low.

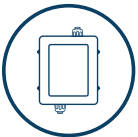

Transfer Switches and Surge Protectors

This article provides an overview of the transfer switch and the integrated surge protector.

The transfer switch allows your coach to be powered by more than one power source, while only allowing one active power source connection at a time. When the generator is turned on, this switch automatically transfers to generator power.

Surge protection was used on select coaches to protect the coach from power surges during storms and poor shore power conditions from the incoming shore power connection. Today, most transfer switches have integrated surge protection.

There will be a slight delay between the start of the generator and the electrical connection. This delay allows the generator to reach normal operating speed without needing to supply a required load. When the unit is plugged into shore power, an audible click will be heard in the transfer switch box. The sound is normal and indicates that the relay inside the transfer switch is engaging the outside power source.

⚠ WARNING

Due to the risk of electrical shock, service should be performed by a qualified electrician or authorized service technician. The electrical system may have multiple 120/240 volt power sources. All power sources must be turned off, and any auto generator start features must be disabled prior to servicing.

NOTE FROM NEWMAR

After market surge protection placed at the shore power supply source is an optional product, which provides an increased layer of surge protection. However, it is not required or installed by Newmar.

Product(s): This information is associated with more than one product. Refer to Newgle for more information about the product(s) offered for your coach's model year.

Southwire 50 Amp Automatic Transfer Switch (Model: 40101-001)

This article provides basic operation instructions for a Southwire 50 Amp Automatic Transfer Switch (Model: 40101).

Testing Operation

Plug the shore power cord into a good shore power source and, after a short delay, shore power should be transferred through and available for use. If the generator is started after approximately 40 seconds, the transfer switch should transfer power from shore power to generator power. Turn the generator off and, after a short delay, the transfer switch should switch back to the shore power. (Source: Doc 505-00175a)

This transfer switch has two visual indicators designed to give the user a quick indication of power conditions that need to be corrected before using the coach.

Open Ground Indicator Illuminated: Unplug shore power. Use a voltmeter to check ground and neutral. Voltage should read -0-. If not, finding another power source is recommended.

Reverse Polarity Indicator Illuminated: Unplug shore power. Use a voltmeter to check ground and neutral. Voltage should read -0-. If not, finding another power source is recommended.

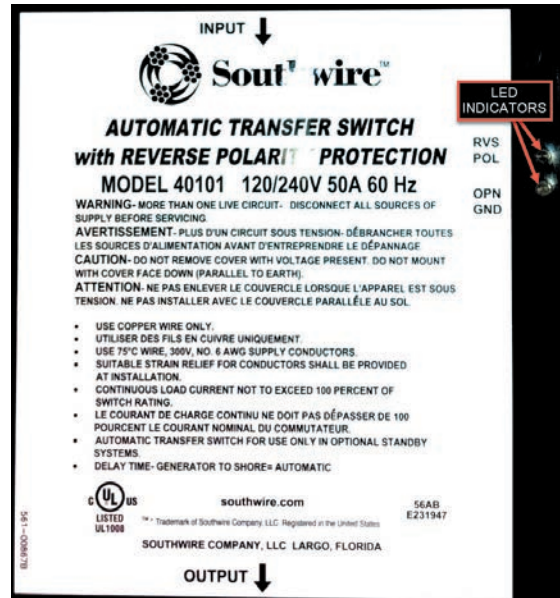

Source(s): Southwire Automatic Transfer Switch Troubleshooting Guide (Models 40100, 40101, 40140, 41300, 41301)

Product(s): Southwire 50 Amp Automatic Transfer Switch (Model: 40101, Newmar Part Number: 157536)

This page is intentionally blank.



ELECTRONICS

This chapter provides operational instructions for the electronic systems installed in the coach, including camera and video, holding tank monitoring, multiplex systems, navigation, security and keyless entry, as well as WiFi.

⚠ NOTICE

NOTE: Audio-Visual (AV) equipment information is located in the Entertainment Systems category.

⚠ IMPORTANT

Any of the following quick start instructions provided by Newmar should not take the place of the manufacturer's complete documentation. Refer to Newgle for more information about electronics offered for your coach's model year.

Dash Infotainment Systems

Xite G4 Infotainment System with 6.5" Touchscreen Operation (Model: XSG4NA-X4S)

This article provides basic operation instructions for a Xite G4 Infotainment System with 6.5" Touchscreen (Model: XSG4NA-X4S).

Features

- RV GPS from NavNGo - Take control of your adventures using NavNGo navigation with online updates.
- House Mode - Control and listen to SiriusXM Satellite Radio from your outside entertainment area.
- HDMI - Connect compatible devices through HDMI and mirror to your G4.
- Media Center - Play back from your USB device or simply copy to the G4 on-board media center. Always have your music, movies and pictures with you.

This Quick Start Guide is intended to provide basic instructions to begin using your Infotainment Center. Failure to properly focus on the operation of your motor vehicle can result in death, serious injury and property damage. The Infotainment Center should never be used at a time or in a manner that distracts you from properly focusing on operation of the motor vehicle in which it is installed.

⚠ IMPORTANT

Please review all disclaimers, warnings and detailed operating instruction in your Xite Owner's Manual prior to using your Infotainment Center.

Main Touchscreen Monitor

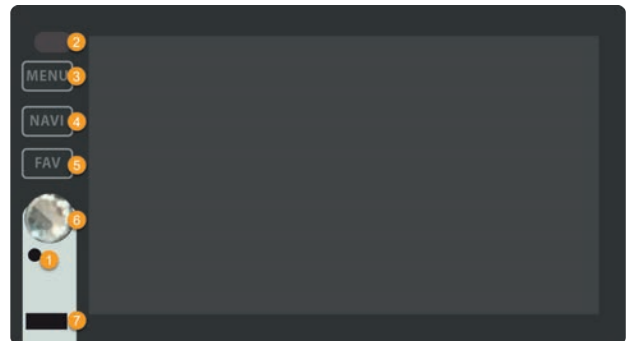

	Function	Description
1	Bluetooth Microphone	
2	LDR (Light Dependent Resistor) and IR (Infra-red Receiver)	<ul style="list-style-type: none"> • LDR is used for the dimming of the display and is active when Auto dim in System Settings is set to Sensor. • IR receiver is used with remote control operations.
3	Menu	<ul style="list-style-type: none"> • Tap MENU button once to go to the Main Menu (or Home Page). • When in the Main Menu, you can either use the touch screen to select the desired icon (source) or you can keep tapping the Menu button to select different icons on the screen. When icon is highlighted for more than 1 second, the system will automatically open that icon. • You can also access the Main Menu from any screen by tapping the function icon in the top left corner of the current screen. • Note: When viewing video in full screen, touch the screen once to bring up the icon header which will display the function icon. Tap the icon to return to the Main Menu.

4	Navi	<ul style="list-style-type: none"> • Press the NAVI button once to go to the navigation system. • While viewing the navigation press the NAVI button to return to the active source (Radio, or SXM, etc.). If the navigation route is running, navigation audio voice prompts will continue to be heard over the speakers according to the Navigation audio settings you have selected in the Settings menu. • To hear only the navigation audio voice prompts, press and hold NAVI button for 2 (two) seconds. This will mute the active source until you leave the navigation screen.
5	Fav	<ul style="list-style-type: none"> • Your Infotainment Center is equipped with a favorite source hotkey. Press the FAV button once to directly access your favorite audio source. • Favorite audio source is defaulted to Sirius XM, and it can be changed by going to Setup -> System -> Favorite Mode.
6	Volume/Power Rotary Button	<ul style="list-style-type: none"> • Turn on the ignition to power up the Infotainment Center. When powered up, it will immediately go to the last mode (memory on playback) before it was turned off. • In order to put the unit in standby mode, press and hold the rotary button once. During standby, your vehicles graphics together with date and time will be displayed. • Press and hold the rotary button again to turn the unit on. • Turn the rotary button left / right to adjust the volume to the desired level. A short press of the rotary button will Mute the audio. • Note: When in standby mode, Infotainment Center consumes power. To completely turn the system on, remove the ignition key and / or ensure any auxiliary battery power to the system is turned off.
7	USB Input	To access and use the USB feature, plug your USB compatible device (USB stick, HD, etc.) into the USB Input. The USB feature on the Main Menu will remain grayed out unless a device is connected.

2	Main Menu	<ul style="list-style-type: none"> • Infotainment Center is designed for simple maneuvering. The screen shown on the left is the MAIN MENU screen. From here, you can choose what source to access by tapping the appropriate icon on the touch screen. • For more information on how to navigate through the Main Menu, please see the Function 3 in the page 5 of the Xite G4 D10 + A7 + SDHD CAM General Information & Setup Guide.
3	AUX Zone	<ul style="list-style-type: none"> • Allows you to select what output is displayed on the Passenger monitor. This is the same as using the SRC button on that monitor.
4	House Mode	<ul style="list-style-type: none"> • This option is only accessible when parking brake is engaged. • When active, House Mode sends current source audio and/or video to other areas of the coach. • After 15 seconds of no input to the touch screen, the LCD displays will enter into sleep. Touch the screen to wake. • House Mode is cancelled when selected again, park brake disengaged or power cycle is performed. • Tap once to enter the House Mode. • Tap once to exit the House Mode.

Main Menu



Function	Description
1	<ul style="list-style-type: none"> • The top area of the screen is the source information bar. It displays the current source together with temperature, compass, and time information as well as the Bluetooth connection status. • Note: One needs to select a source to be able to see all the information mentioned above.

Settings

Access the Settings by selecting the Setup icon in the Main Menu. There are three Settings that can be changed and these are System, Video, and Audio. In addition, there are Settings for Radio, Sirius XM, Bluetooth and DVD, and to access these, you must go to the setup icon while one of these sources is active. To exit the Settings menu at any time, press the Settings icon in the top left of the screen.

SYSTEM SETUP

By touching the SYSTEM button, the settings for the system part of the Infotainment Center can be changed.

- Auto Dim
- Dim (Day Time)
- Dim (Night Time)
- Beep Tone
- Standby Screen
- Temperature
- Compass Display
- Time Set
- Favorite Mode
- Coach Warning
- Language
- Factory Set
- WiFi Settings

VIDEO SETUP

By touching the VIDEO button, the settings for the video part of the Infotainment Center can be changed.

- Brightness
- Contrast

AUDIO SETUP

- Treble Gain
- Mid Gain
- Bass Gain
- Equalizer
- Fader
- Balance
- Center/Woofer Volume

- Loudness
- NAV Volume: Sets the gain of navigation volume (-10 to +10). 0 is the center. This feature will help balance the navigation audio prompts with the system volume level according to the individual user preference.
- NAV Audio Mix: This option allows setting the way of navigation voice behavior in relation to the normal audio playback. The following options are available:
 - OFF: Navigation voice will not be audible.
 - MIX: Navigation voice will mix through normal audio.
 - FULL: Normal audio will be muted on the front speakers during navigation voice instructions.
 - Note: Navigation voice prompts can only be heard on front speakers.

For More Information

Refer to the G4 D10 + A7 + SDHD CAM General Information & Setup Guide for more information about your Radio Operation, Media Center, Bluetooth Operation, SiriusXM, iPod & iPhone AV Interface, HDMI, Split Screen, Camera, Navigation, House Mode, and Customer Feedback and Product Registration.

CONTACT XITESOLUTIONS NORTH AMERICA INC.

- Website: www.xsna.ca
- Email: support@xsna.ca

CONTACT RIVERPARK INC.

- Website: www.riverparkinc.com
- Email: navi@riverparkinc.com
- Toll Free: (800) 442-7717

Source(s): G4 D10 + A7 + SDHD CAM General Information & Setup Guide (Version 210427.01)

Product(s): Xite XSG4NA 6.5" Touch Screen Infotainment Navigation System (FCCC) (Model: 125XS90111FKT10, Newmar Part Number: 155707) and Xite XSG4NA 6.5" Touch Screen Infotainment Navigation System (Spartan) (Model: 125XS90111FKT11, Newmar Part Number: 155708)



Cameras and Video Monitoring Systems

Camera and Video Monitoring System Overview

This article provides an overview of the camera and video monitoring system. The video system features cameras mounted on the exterior of your coach and is connected to the in-dash video screen. This system comes on automatically when you put the transmission in reverse to allow you to see behind your unit when backing up. Additionally, it can be manually turned on in transit to allow you to monitor your towed vehicle or for additional assistance in passing maneuvers.

Rear View Cameras

Installed as a standard feature, the rear view monitor system assists the driver in the backing and parking of the vehicle. This system consists of a camera mounted on the rear cap and a monitor located on the dash.

Side View Cameras

As an option for the rear vision system, your unit may be equipped with "side view" cameras. These cameras are tied into the rear vision system and are activated by the turn signals. When a turn signal is activated, the monitor will switch to display that side of the unit. Once the turn signal cycle is complete, the display will revert back to the previous camera for the Voyager system and Xite system. In some Xite systems, the camera selection may default back to the rear camera.

Camera Selection

If the rear vision monitor is turned on manually, you can toggle through the cameras by using the "Source" button on the Voyager system, or the "Menu" button followed by the "Camera Select" icon on the Xite system, allowing you to stay on any given camera that you choose unless a reverse or turn signal is detected. Select Xite systems may have a "CAM" button that serves as a shortcut to the camera settings. Xite systems with a "360 Camera Select" switch allows the user to toggle through and select multiple camera views.

Voyager LCD 3-Camera Mirror Monitor Operation (Model: VOM718)

This article provides basic operation instructions for a Voyager LCD 3-Camera Mirror Monitor (Model: VOM718).

Controls and Operation

POWER ON/OFF (1)

- Press once to run on unit.
- Press again to turn off unit.

LEFT/RIGHT ARROWS (2, 3)

- Primary Function: Pressing arrow buttons increases/decreases brightness, contrast, color, tint, volume.
- Secondary Function: While in menu modes, the arrows are used to select the option setting.

DAY/NIGHT (4)

- Switch between day and night mode.

MENU (5)

- Primary Function: Press MENU button to enter the OSD.
- Secondary Function: While in menu modes, the MENU button is used to return to the previous menu.

SELECT (6)

- Primary Function: Press SELECT button sequences source input modes from CH1 to CH3.
- Secondary Function: While in menu mode, the SELECT button is used to select the highlighted function or option setting.

Refer to the Voyager owner manual for additional functions and setup instructions.

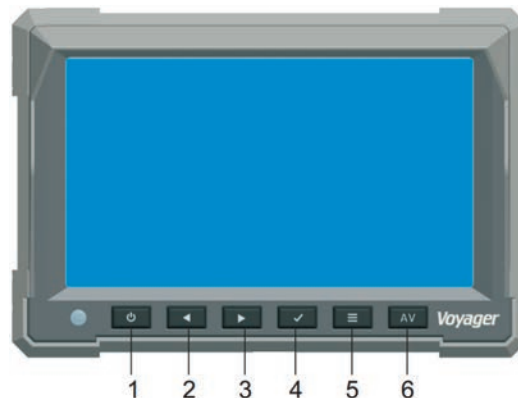

Source(s): Voyager VOM718 7" Color TFT LCD 3 Camera Mirror Monitor Owner's Manual
 Product(s): This source is associated with more than one product. Refer to Newgle for more information about the product(s) offered for your coach's model year.

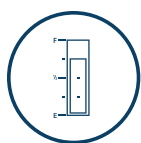

Holding Tank Monitoring Systems

The monitor panel allows you to check the approximate levels in the fresh, gray, and black water holding tanks, as well as propane levels (if equipped), and the battery condition. The monitor panel is generally located in the front overhead cabinet, or above or near the entrance door. An additional monitor panel may be located in the basement water compartment.

Precision Circuits Holding Tank Monitoring Systems Operation (Model: Digi-Level)

This article provides basic operation instructions for a Precision Circuits Digi-Level Holding Tank Monitoring System.

The monitor panel allows you to check the approximate levels in the fresh, gray, and black water holding tanks, as well as propane levels (if equipped), and the battery condition. The monitor panel is generally located in the front overhead cabinet, or above or near the entrance door. An additional monitor panel may be located in the basement water compartment.

Overview

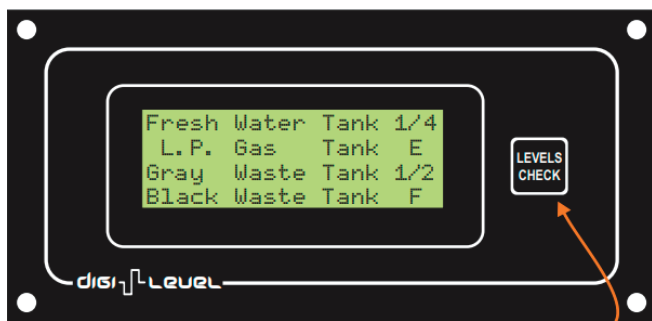

Pressing this button will scroll through the multiple info screens

The Digital Monitor Panel digitally displays the levels of the Water and Waste Tanks, and L.P. Tank. It provides both a digital and analog Battery Volt Meter.

To conserve battery power, after one minute, the backlighting will turn off, and the display will return to a default screen. However, the panel is still live. Touching the button will display the level and also turns on the backlighting again.

Digi-Level Screens

TANK LEVELS SCREEN

Press the "Levels Check" button to check the tank level statuses. The levels will show on the digital display.

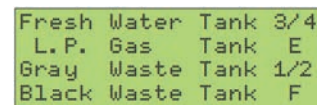

The screen will continually update every second, and the level sensors are continually communicating. Should a sensor exceed normal limits, "ERR" will display in place of the level. Depending on the RV, the levels will be displayed in either 1/3's or 1/4's.

- E, 1/3, 2/3, F, or ERR; or
- E, 1/4, 1/2, 3/4, F, or ERR.

VOLTAGE SCREEN

The chassis and house battery voltages will display in both digital and analog (bar graph) format.

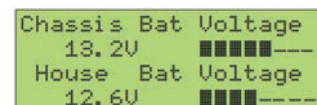

The analog range is 10.0 volts to 15.0 volts, with bar graph meter increments of 0.125 volts. The screen will continually update every second. Below are some guides to determine the battery charge state:

- Over 13.0 volts, the battery is being charged.
- If no appliances, lights, Inverter, etc are on, a battery at rest voltage will have an approximate battery charge state range from 11.8 volts (0% charge) to 12.8 volts (100%).

GENERATOR SCREEN

The display will show the status of the generator:

- Running
- Stopped
- Hour Meter (if installed by the OEM)

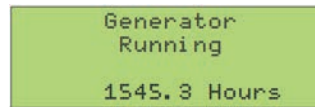

NOTE FROM NEWMAR

The generator screen is only available on select coach models and years.

Tank Sensor and Calibration

The tank sensor features field effect technology, a non-invasive method. Each sensor array contains three sensors which glue externally to the polymer tank wall with high-grade, long-life adhesive, at the position and level that the water is to be sensed, thus eliminating the need for calibration.

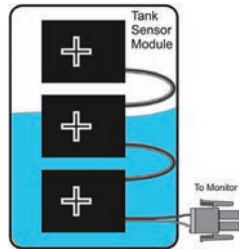

Each sensor emits an electric field into the tank. When the water level passes by the sensor, it detects a change in its electric field.

Automatic Learn Feature and Resetting The Panel To Default

The Digital Monitor Panel has two automatic learn features and it will learn if the water and waste tanks have 1/3 or 1/4 increment sensors and if the LP sensor exists. Each feature is learned independently, even for the individual tanks. Once a feature is learned, it is stored in non-volatile memory, and remembered even if battery power is removed from the panel. The Digital Monitor Panel has many safe guards to prevent improperly learning a feature. Should the panel learn something incorrectly, an option exists on the panel to reset the original factory default, so that the panel can re-learn the proper features.

TANK LEVELS SCREEN

1. Touch the “Levels Check” button as many times as needed to get to the Tank Levels screen.

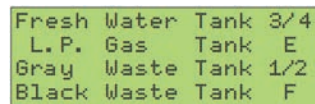

Navigation System

Your coach may be equipped with a GPS based Navigation system. This system uses GPS technology to guide you through maps and information for traveling assistance. It features voice prompts and touchscreen technology to make scrolling through the menus and getting information incredibly easy.

The navigation feature is intended to assist you with guidance to your destination. The system may need software and map updates. Updates are not warrantable issues, as roadways change over time and construction takes place, the maps and/or systems may become obsolete.

VOLTAGE SCREEN

2. Press and hold the “Levels Check” button for approximately six seconds. The Voltages screen appears right away, but continue holding the button.

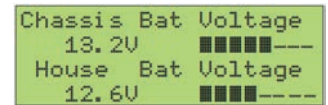

FACTORY MODE SCREEN

3. Once Factory Mode screen appears, release the “Levels Check” button, and quickly press and release again.



FACTORY RESET SCREEN

4. If done properly, the Factory Reset screen should appear. Factory Default settings have been reset, and the panel will go through the power-up screen. If not, go back to step one, and repeat the process.

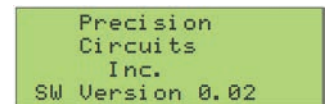

Performing A Levels Check

For coaches not equipped with the SilverLeaf system, simply press the “Levels Check” button to check the tank level statuses. The levels will show on the digital display.

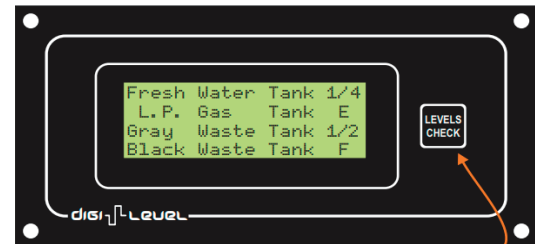

Monitor Panel Calibration

The monitor panel has been calibrated for accuracy prior to leaving the factory and should not need to be adjusted. In the event that the system does not read accurately, then re-calibration may be necessary. Follow the manufacturer’s procedures for re-calibration for your specific product. It is recommended to have a qualified service technician perform the re-calibration procedure.

CAUTION

It is the driver’s responsibility to make sure the roads are safe and appropriately navigated and roadway weight limits and clearances are rated for the vehicle you are driving.

⚠ WARNING

The navigation system is NOT intended to replace, supersede, or take precedence over any traffic signs, street signs, hazard signs, etc.

NavNGo Navigation System Operation via Xite Infotainment System

This article provides basic operation instructions for the NavNGo Navigation System via Xite Infotainment System (Model: XSG4NA).

Getting Started

The XSG4NA range of infotainment systems come with an on-board Navigation program. This Navigation program is preloaded to the internal memory of the XSG4NA Product. In order to provide the best possible user experience, the XSG4NA comes with a range of Connected Services to make the usage of the product as easy as possible. These Connected Services are:

Note from Newmar: to use any of the connected services the user must have the xite system connected to the internet via an active connection.

ONLINE TRAFFIC

This feature will automatically download and analyze real time traffic information and provide you with Route alternatives if you are already on the road and heading to a traffic event. Or the Online traffic will calculate around traffic when you start your new route.

ONLINE WEATHER

The Online weather service information can be used to view weather at your destination or along your current route.

ONLINE POI SEARCH

The Online POI search option is an extension of the pre-loaded database. The online POI's will provide you update to date Points of Interest with the latest available information.

OVER THE AIR UPDATES

Over the Air updates will allow you to update your maps, POI database and the Navigation program itself via an internet connection. You will be automatically notified when new updates are available and can download them when it is most convenient for you.

⚠ IMPORTANT

Map updates can be large (3GB+ of data), so it is advisable to perform these updates when connected to a Wi-Fi connection and not perform the update via a phone tether.

When you start using the product, you can download updates, at no cost, for the next 3 years.

Additionally, the XSG4NA is pre-loaded with the “Truck Attribute Map data”. This additional map data contains additional road information in relation to road attributes. Items such as weight restrictions, bridge heights, limitation of number of axles, tunnel restrictions, etc. This additional map data is of great relevance to RV owners to ensure that the roads suggested by the Navigation program are suitable for the specific RV.

⚠ IMPORTANT

The suggested routes to your destination are only as good as the information provided to the program to calculate with. Make sure to set up the vehicle settings correctly and accurately to ensure that the routes suggested by the Navigation program are suitable for your vehicle. Failure to do so accurately may lead you down roads that are unsuitable for your vehicle resulting in damages to your vehicle, the roads, or violation of traffic laws.

Warnings and Safety Information

The navigation system helps you find your way to your destination based on GPS positioning. The XSG4NA does not transmit your GPS position; others cannot track you.

It is important to look at the display only when it is safe to do so. If you are the driver of the vehicle, it is recommend that you plan and review your route before you start your journey. Plan the route before your departure and stop if you need to change the route.

Always follow traffic rules at all times. If you deviate from the planned route, the program will recalculate and change the instructions accordingly.

INITIAL SET-UP

When using the navigation program for the first time, an initial set-up process starts automatically. This Initial setup is also repeated when the “Factory Reset” is done in the Navigation program setup menu.

1. Select your preferred language, then tap SELECT to confirm your selection. Later you can change it in Regional settings.
2. After accepting the End User License agreement, the Configuration Wizard starts. Tap the NEXT button to continue.

3. Select the language and speaker used for voice guidance messages. You can also change it later in the “Regional settings”. Select your preference and tap NEXT to continue.
4. If needed, modify the time format and unit settings. You can also change it later in the “Regional settings”. Tap NEXT to continue.
5. In this step you can adjust the routing preferences. Please take care to accurately insert all your vehicle parameters. The Navigation program will take this information into account to provide you with a route that avoids any roads that contains obstacles that should be avoided (low bridges, weight restrictions, etc.) If the information entered is incorrect, the program cannot take these vehicle specific restrictions into account. You can also change it later in the “Route Preferences”. Tap NEXT to continue.
6. The initial set-up is now complete, tap Finish to enter the Navigation view.

SCREEN CONTROLS

The following sections describe the functionality and use of buttons, sliders, and other screen controls in the Navigation program.

USING BUTTONS AND OTHER CONTROLS

Type	Description	Function
Button	Opens a new screen where you can set a parameter.	Tap it once.
Button with Value	Displays the current value of a field or setting where the value can be changed. After the change, the new value is shown on the button.	Tap it once.
Icon	Provides additional information, for example traffic summary or itinerary.	Tap it once to open a screen with additional information or options.
List	Shows multiple options.	Grab the list anywhere and slide your finger up or down. Depending on the speed of sliding, the list scrolls fast or slow, only a bit or till the end. Alternatively, move between items in a list with the arrows and tap the value that you want to select.
Switch	Shows whether a feature is enabled when there are only two choices.	Tap it to turn the switch on or off.
Slider	When a feature can be set to different values in a range, the program shows an indicator on a gauge that displays and sets the value.	Drag the handle to move the slider to its new position. Tap the slider where you want the handle to appear.
Virtual Keyboard	Used to enter text and numbers.	Each key is a touch screen button.

The Navigation menu contain several menu items on one or more pages.

The UP ARROW button is always present in the top left corner of the screen. Pressing this button will bring you back to the Map view immediately regardless of where in the sub menu you are.

NAVIGATION VIEW

The navigation view is the main screen that shows the planned route on a map. The program works with digital maps which are not simply the computerized versions of traditional paper maps. Similar to paper road maps, the 2D mode of digital maps shows you streets and roads. Elevation is also illustrated in color.

The navigation view displays the following screen buttons, data fields, and route information on the map during navigation:

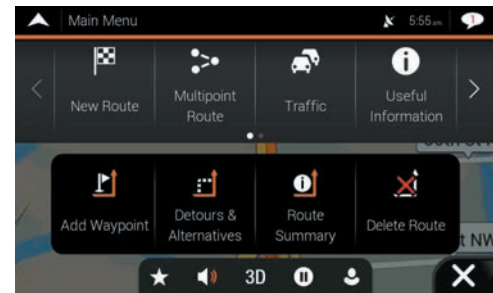

NOTICE

Some buttons, fields, or icons may not be available in your product version.

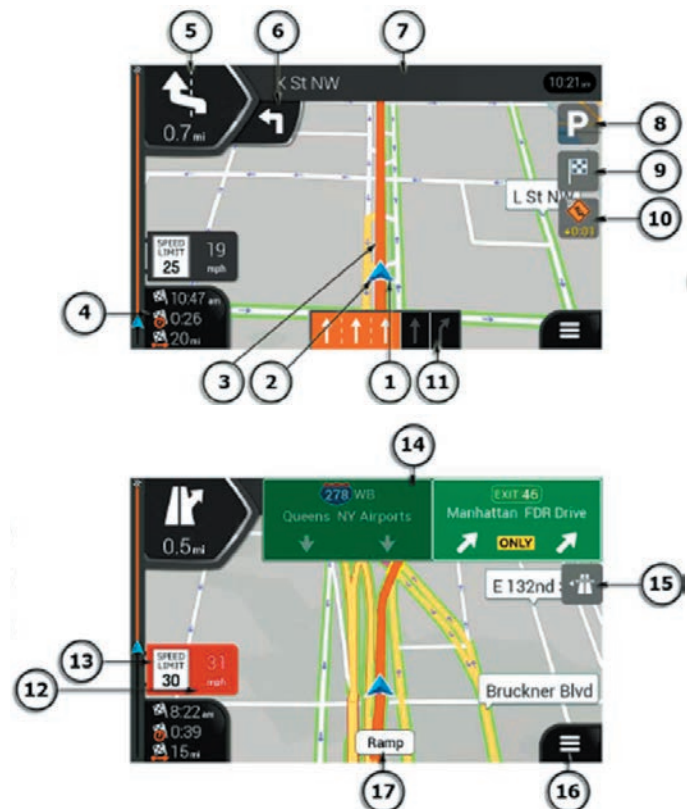

Number	Name	Description
1	Current Position Marker	The current position is displayed as a blue arrow by default. When there is no GPS position, the current position marker is transparent and it shows your last known position.
2	GPS Position	The dot near the arrow shows the GPS position as perceived by the GPS receiver.
3	Planned Route	The planned route is displayed as an orange line.

4	Data Fields	Three data fields show the following information: <ul style="list-style-type: none"> The estimated time of the arrival at the destination. The remaining time of the trip. The remaining distance to the destination. You can change the default values in Settings or by tapping and holding the area where the data fields appear. If you have not selected a destination, you can see your heading instead of the three data fields.
5	Next Turn Preview	It shows the type of the next maneuver and its distance.
6	Second Next Turn Preview	It shows the type of the second next maneuver if it is near the first one.
7	Next Street	It displays the name of the next street. If you have not selected a route destination, you can see nearby house numbers, if they are available.
8	Parking Around Destination	It appears near the destination. By tapping it, you can check the available parking facilities around your destination.
9	Destination Menu	It appears near the destination. By tapping it, you can check the trip summary, find Places around your final destination, save the current location, or suspend the navigation.
10	Traffic	It shows traffic-related information.
11	Lane Information	On multi-lane roads, it shows the lanes ahead and their directions. The highlighted arrows represent the lanes and direction you need to take.
12	Alert Point Warning	It shows the type of the alert points when approaching a road safety camera or other Alert Points like school zones or railroad crossings. You must make sure that using this feature is legal in the country where you intend to use it.
13	Speed Limit Warning	It shows the current speed and the speed limit when speeding.
14	Signpost	It shows the available destinations and the road numbers.
15	Freeway Services	By tapping it, you can check the details of the next few service stations (gas stations, restaurants) when traveling on a freeway.
16	Navigation Menu	By tapping it, you can open the Navigation menu, where you can reach other parts of the program.
17	Street Name	It shows the current street name. By tapping it, you can open the Where Am I screen.

Settings Menu

You can configure the navigation settings, and modify the behavior of the program, by tapping the MENU button (3 horizontal lines), followed by the SETTINGS button.

⚠ NOTICE

Changing some of these settings may not have an effect in your current region if the map data do not contain the required information.

The Settings menu provides the following options:

BUTTON	FUNCTION
Route Preferences	Select the type of vehicle you are driving, the road types used in route planning, and the route planning method.
Sound	Adjust the different sound volumes.
Warnings	Enable and set up warnings for speed limit, Alert Points (such as speed cameras).
Navigation View	Fine-tune the appearance of the Navigation view or adjust how the program helps you navigate with different kinds of route-related information on the Navigation view.
Regional	Change the voice guidance language, set the time zone, the measurement units, the time and date formats, and customize the application for your local language.

Display	Enable or disable menu animations.
Traffic	Enable or disable traffic information and modify detour settings.
Weather	Enable the online weather forecast and the automatic download of weather information.
Online Services	Enable or disable services that require Internet connection.

ROUTE PREFERENCES SETTINGS

The following settings determine how routes are calculated:

BUTTON	FUNCTION
Vehicle	Set the type of vehicle you want to use to navigate the route. Based on this setting, some of the road types can be excluded from the route, or some of the restrictions may not be taken into account in route calculation.
Route Planning Method	Optimize the route calculation for different situations and vehicle types by changing the planning method.
Navigation Mode (On-Road)	Select on-road or off-road navigation.
Road Types	Select your preferred road types for the route.

VEHICLE TYPE SELECTION

Press this option to open the vehicle type selection menu. The following option are available per default:

BUTTON	FUNCTION
Car	Maneuver restrictions and directional constraints are taken into account when planning a route. Roads are used only if access for cars is allowed. Private roads and resident-only roads are used only if they are inevitable to reach the destination. Walkways are excluded from routes.
Bus	Maneuver restrictions and one-way streets are taken into account when planning a route. Roads are used only if access for buses is allowed. Private roads, resident-only roads and walkways are excluded from routes.
Class A RV	The Class A RV vehicle profile is set with default values for a generic Class A RV. Maneuver restrictions and one-way streets are taken into account when planning a route. Private roads, resident-only roads and walkways are excluded from routes. If the map contains data on dimension, weight, number of axles they can also be taken into account when planning a route.
Class B RV	The Class B RV vehicle profile is set with default values for a generic Class B RV. Maneuver restrictions and one-way streets are taken into account when planning a route. Private roads, resident-only roads and walkways are excluded from routes. If the map contains data on dimension, weight and freight restrictions, they can also be taken into account when planning a route.
Class C RV	The Class C RV vehicle profile is set with default values for a generic Class C RV. Maneuver restrictions and one-way streets are taken into account. Roads are used only if access for buses is allowed. Private roads, resident-only roads and walkways are excluded from routes. If the map contains data on dimension, weight and freight restrictions, they can also be taken into account when planning a route.
Truck	Maneuver restrictions and one-way streets are taken into account when planning a route. Roads are used only if access for trucks is allowed. Private roads, resident-only roads and walkways are excluded from routes. U-turns are excluded from routes (turning back on a divided road is not considered as a U-turn). If the map contains data on dimension, weight and freight restrictions, they can also be taken into account when planning a route.
Add New Vehicle	With this option you can add your own vehicle profile.

MODIFYING VEHICLE PROFILES

In vehicle profile selection screen, press the UP ARROW and then the EDIT button to access the vehicle profile settings to adjust for your specific vehicle parameter. In Edit mode, you will see the symbol behind each vehicle type. Tap the symbol to access and select the details of the vehicle profile. Here the following basic options can be changed:

- Name (Allows you to rename the vehicle profile if desired)
- Vehicle type
- Maximum speed of the vehicle
- Fuel consumption in cities
- Fuel consumption on highways
- Engine type



Fuel consumption and engine type information is used to calculate and estimate amount of fuel needed as well as the approximate of CO2 produced. Also changeable for larger vehicle profile types are the “Extended Vehicle Settings.”

EXTENDED VEHICLE SETTINGS

The extended vehicle settings allow drivers to further specify their vehicle parameters to allow the program to offer the best available route for their vehicle type. Please make sure that all the specifics of your vehicle (height, weight, axles, etc.) are correctly entered into the vehicle profile settings. Incorrect settings will result in incorrect routes.

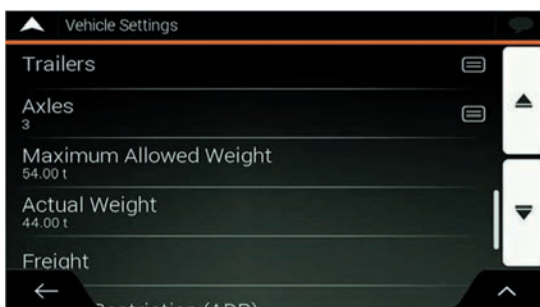
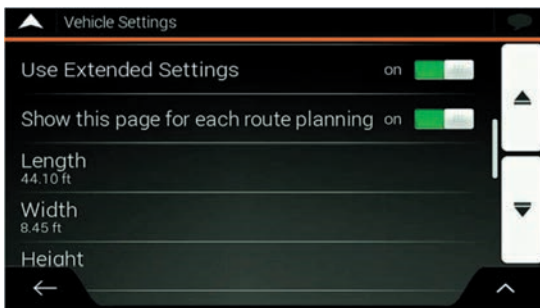

By default the option “Show this page for each route planning” is enabled. This option will prompt you to confirm that the vehicle profile specification is still accurate.

Warnings Settings

SPEED LIMIT

The program is able to warn you if you exceed the current speed limit. This information may not be available in your region, or may not be fully correct for all roads on the map. This setting lets you decide whether you wish to receive visible and/or audible warnings. The following warning types are available:

- Visual warning: the current speed limit is shown on the map when you exceed it.
- Audio and Visual warning: besides the current speed limit being shown on the map, you also receive a verbal warning when you exceed the speed limit with the set percentage.

If you prefer to see the speed limit sign on the map all the time (normally, it is shown only if you exceed the limit), you can set it here. You can also set the relative speed above which the application initiates the warning by adjusting a slider. The value can be different within and outside Cities.

DISABLING THE SPEED LIMIT WARNING

Issue: The speed limit warning is signaling even when the actual speed limit is kept.

Cause: The speed limit in the digital map data might differ from the actual speed limit of your current location.

Solution: Disable the speed warning by performing the following steps.

1. Tap the MENU button (3 horizontal lines).
2. Tap the SETTINGS button.
3. Tap the WARNINGS button.
4. Tap the Speed Limit button.
5. Tap the Warn When Speeding (Audio and Visual) button
6. Tap the Disabled option.

ALERT POINTS

Tap it to receive a warning when approaching a road safety camera or other Alert Points like school zones or railroad crossings. You must make sure that using this feature is legal in the country where you intend to use it. You can set the warning type for the different Alert Point categories (alert types) individually. The following warning types are available:

- Visual warning: the type of the Alert Point, its distance, and the related speed limit appear on the Navigation view while you are approaching one of these locations.
- Audio and Visual warning: besides the visual alert, beeps are played (when using a natural voice) or the type of the alert is announced (in case of a TTS voice) while you are approaching one of these points, and an extra alert warns you if you exceed the given speed limit while approaching.

For some of the Alert Points, the enforced or expected speed limit is available. For these points, the audio alert can be different if you are below or above the given speed limit.

- Only when speeding: The audio warning is only played when you exceed the given speed limit.
- When approaching: The audio warning is always played when approaching one of these Alert Points. In order to draw your attention, the audio alert is different when you exceed the speed limit.

Factory Reset or Reset All Settings

A factory reset can be done to restore all the factory default settings. The factory reset will also erase all user content (Search History, Routes, etc.).

1. Tap the MENU button (3 horizontal lines).
2. Tap the SETTINGS button.
3. Tap the UP ARROW to open the menu options.
4. Select either “Reset All Settings” or “Factory reset” to restore to the original default state. The application will prompt to confirm your selection. The application will restart to apply the changes.

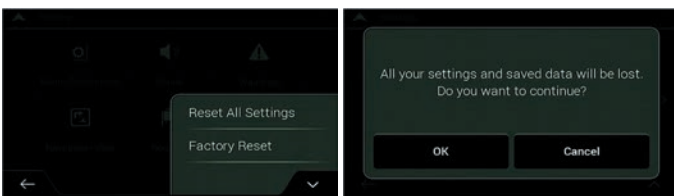

Updates

The XSG4NA is set up to only allow Over the Air updates. This means that the program will allow you to update new maps/POI databases or the program itself **via an active internet connection**.

When the program detects an active internet connection, it will automatically check whether updates are available for you to download.

UPDATES AVAILABILITY

There are 2 ways that the program will let you know an update is available.

- Via the message icon in the top right of the screen
- Press the MENU button (3 horizontal lines), followed by the SETTINGS button, and the SHOP button.

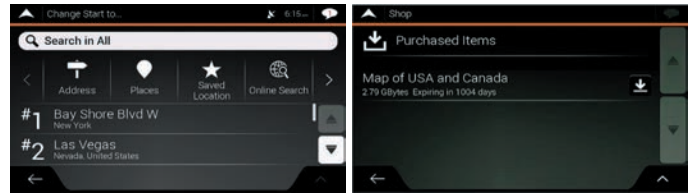

UPDATE INSTALLATION

If updates are available and you wish to install them, please make sure that you are connected to the correct WiFi Access point before starting up the update.

⚠ IMPORTANT

Updates can be very large and when connected over a cellular network via your phone, data transfer costs can occur. Do not switch off or restart the system during the download and installation of an update.

To start the update, press the DOWNLOAD button in the line of the update you wish to install. The update will start momentarily, and a status update will show the progress:

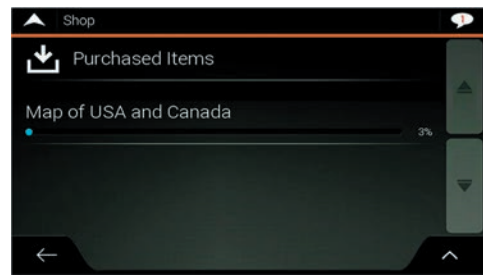

After the download and installation is completed, the program will prompt you to install the update:

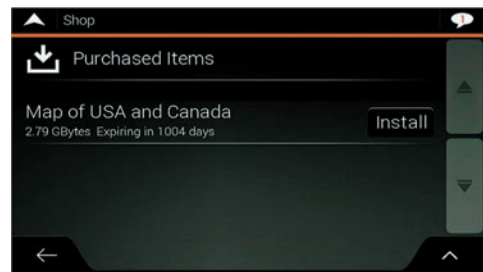

After the install, the program will prompt to restart and apply the updated portions:

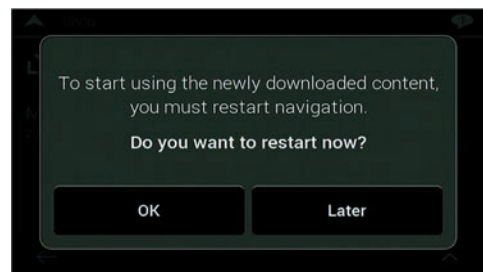

Select “OK” and the program will restart and is updated.

*Source(s): Xite Solutions North America XSG4NA User Manual Version 032221.01
Product(s): This source is associated with more than one product. Refer to Newgle for more information about the product(s) offered for your coach's model year.*

How to Update Vehicle Profile Settings on an Xite G4 NavNGo Navigation System

This article provides a quick step-by-step guide on how to select the appropriate vehicle profile in the [Xite G4 NavNGo] Navigation software to ensure the correct routing.

- System: XSG4NA generation
- System OS: All
- Navigation: NNG

The first time the Navigation software is used, it will present a setup wizard to guide you through the basic settings:

Configuration Wizard

1. Select the appropriate language for the user interface. When the correct language is highlighted, press the “Select” button at the bottom of the page to continue to the next step.

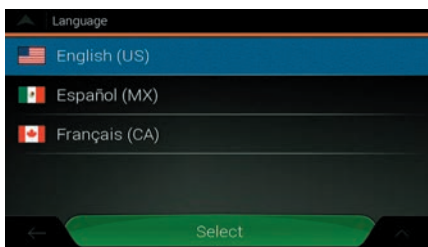

2. Accept the license agreement by pressing “Accept.”

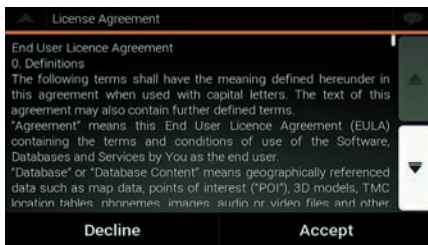

3. Proceed to the configuration wizard by pressing the “Next” button at the bottom of the page.



4. Select the desired voice profiles. When the selection is made and highlighted, press “Next.” Note that during this step, the normal audio from the G4 will be suppressed.

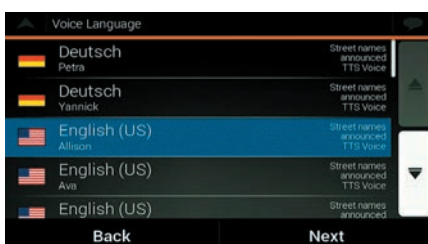

5. This page will allow you to change the units and formats used by the Navigation software to show you that information. By pressing the icon at the end of the line, you can change that specific setting.



6. In the route preferences, you can change the options for the actual routing. Make sure that the Vehicle profile line shows the RV class that the system is being used in. You can change that by pressing on that line in the page and select the required vehicle profile. When the correct vehicle profile is highlighted, press the “Back” button, and it will show your selection in the overview page of the Route preferences.

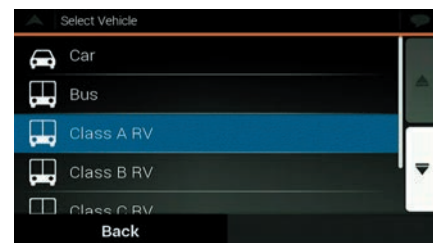
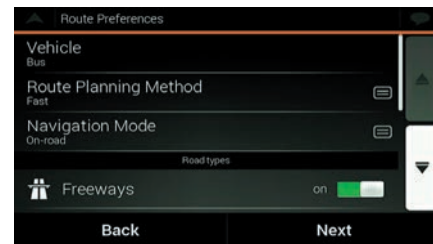

7. When completed, press the “Next” button to proceed.

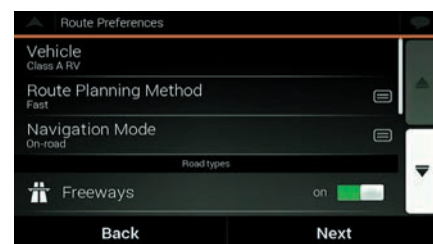

8. The configuration wizard is completed. Press the “Finish” button to complete the configuration and start the navigation program with your selected settings and options.



MANUAL CHANGES

Changes can be made later on as well, if needed, to update the routing preferences or the vehicle specific variables.

1. Open the main menu and select the “Settings” page. When in the settings page, select the “Route Preferences” option.

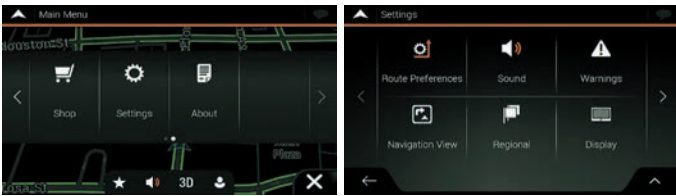

2. In the Route Preferences menu, you can select the Vehicle line to access the vehicle profile selections.



3. When in the vehicle selection list, press the Arrow up icon in the bottom right corner to access the “Edit” function.

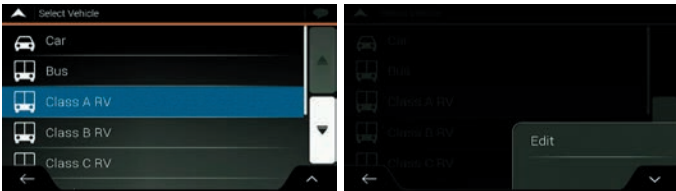

4. Select which vehicle profile you would like to edit by tapping the icon behind the vehicle profile name, and select the “Modify Vehicle” option to access the specifics of the selected vehicle profile.

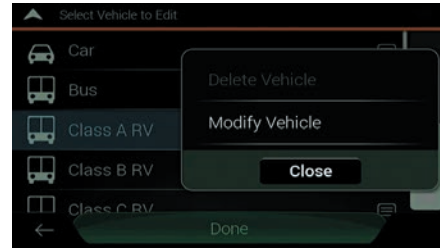

5. Change the vehicle profile variables you want to change here (length, weight, height, etc.). Scroll through the list to see all options.

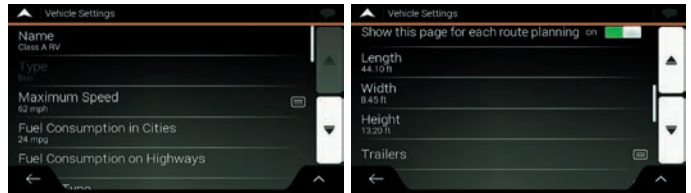

6. When all the changes are completed, press the back arrow to return to the vehicle profile list, and press “Done” to finish the modifications to the vehicle profiles.



Source(s): Xite G4 Navigation Vehicle Profile Settings (April 2021)

Product(s): This source is associated with more than one product. Refer to Newgle for more information about the product(s) offered for your coach’s model year.



WiFi Systems

Due to the ever-growing demand of internet connectivity, a WiFi system in your coach can mean the difference between using costly mobile data and being able to access free WiFi wherever your travels may take you. Your coach may be equipped with one of the many options WiFi systems Newmar offers.

WiFi Ranger Converge LTE Indoor/Outdoor Router Operation (Model: Teton/Popular Combo)

This article provides an operational overview of the WiFi Ranger Converge LTE Indoor/Outdoor Router (Model: Teton/Popular Combo and Denali/Spruce Combo). This information only applies to coaches equipped with an optional WiFi Ranger Converge Router.

Components



Get the most out of a WiFi Ranger system with an indoor & outdoor pack [...] for more network versatility and functionality when compared to a standalone unit. All of the long-range WiFi, LAN ports, USB tethering, and upgradability features unite in these Packs. Furthermore, you will enjoy maximum wireless coverage, performance, and reliability when using a Pack.

INDOOR ROUTERS

- Poplar: WiFiRanger Poplar is an entry-level mobile router with 2.4GHz WiFi, a USB port for LTE tethering, 100Mbps LAN ports, and an integrated LTE modem (optional).
- Spruce: WiFiRanger Spruce is a mid-performance mobile router with 2.4GHz / 5.8GHz WiFi, a USB port for LTE tethering, and 100Mbps LAN ports.

OUTDOOR ROUTERS

- Teton: WiFiRanger Teton is an entry-level outdoor router with 2.4GHz WiFi, 1mi range, a 100Mbps LAN port, and an integrated LTE modem (optional).
- Denali: WiFiRanger Denali is a mid-performance outdoor router with 2.4GHz WiFi, 1.5mi range, a 100Mbps LAN port, and an integrated LTE modem (optional).

Quick Start Guide

1. Power up your WiFi Ranger(s). Follow steps from Rooftop Installation and Interior Installation in order to power up unit(s), then wait 5 minutes.
2. Wirelessly connect your device to your WiFi Ranger. Network names vary depending on which WiFi Ranger model(s) you have. Not that the blank space need to be filled in with the 4 unique digits of your WiFi Ranger(s).
 - Pvt. WFR__Teton.___
 - Pvt. WFR__Denali.___
 - Pvt. WFR__Poplar.___
 - Pvt. WFR__Aspen.___



3. Enter Password: changemenow__ __ __ __. Enter password in lower case with no spaces. Note that the blank spaces need to be filled in with the 4 unique digits of your WiFiRanger(s).

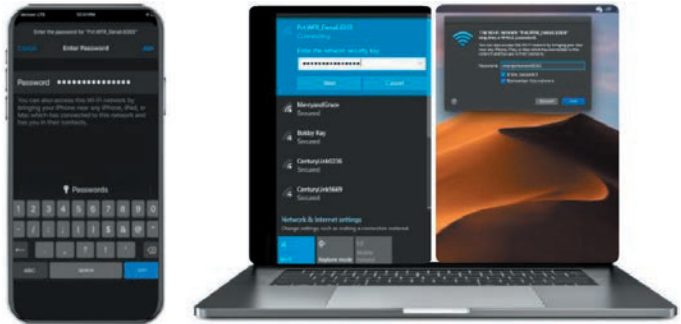

4. Visit mywifiranger.com. This brings up the WiFiRanger Control Panel which can be bookmarked for future access.
5. Click Connect on WiFi network or Cellular device. For filtered WiFi networks, proceed to the captive portal or login page and enter the necessary credentials or terms of service.



LTE Activation

WiFiRanger is pleased to provide LTE solutions that are not locked into a specific cellular carrier. This approach gives the customer increased flexibility over other competing offerings which are tied to singular carriers or data plans. The WiFiRanger LTE solution gives you the freedom to find the perfect plan for you. The cellular landscape is always evolving and advancing, so our goal is to assist you in making the most of the myriad of data options available. The following advice is to help you navigate the data plan and activation topics that are applicable to our LTE solutions. The LTE solutions offered by WiFiRanger are subject to change based on the evolving cellular landscape.

IMPORTANT CONSIDERATIONS

A. Data Plan Availability Varies by Region

- Some cellular carriers offer certain data plans by region. As such, you may find that the data plan that you desire is available through a cellular reseller or representative in another area while your local representative has more limited options. Check around or call a representative in another region if you can't find what you want locally.

B. SIM Card Type May Affect Data Plan Options

- WiFiRanger provides standard consumer SIM cards with their LTE modems. These SIM cards may not work on business data plans, but should support most consumer data plans. It is important to ask your cellular carrier if the SIM card you provide them is the right kind to meet your data needs.

C. Ease of Modem Activation Varies by Reseller / Carrier

- In some cases, it can be difficult to activate the WiFiRanger LTE modem and SIM card depending on the representative you speak with. Some representatives work for a cellular reseller that does not have the offerings you desire, or you may need a more knowledgeable representative to handle your request. Ask different cellular stores, resellers, or a direct Carrier representative until you find the right person to activate your modem and SIM card on the desired plan.

D. Data Plan Pricing Depends on Your Cellular Account

- In large part, the price of data plans for the WiFiRanger LTE modem are affected by your cellular account type and other data plan(s) on your account. In some cases, the WiFiRanger LTE modem will require having a data-only plan that is separate from the data plan attached to your smartphones or other devices. Checking with your carrier on costs will help you to understand how the carrier will handle the WiFiRanger LTE modem pricing and data amounts available.

E. Upgrading from Non-LTE WiFiRanger to LTE Modem May Require Additional Steps

- If you are upgrading a from a non-LTE WiFiRanger router to an embedded LTE modem, please be sure to click Check for Updates on the WiFiRanger Control Panel after installing the modem or upgrade kit. If you are experiencing problems or have questions about the new LTE modem, contact WiFiRanger to assist in getting your WiFiRanger configured to support the new modem. Our contact info is listed on the bottom of this guide.

F. Changing Cellular Carriers Should Only be Done After Verifying Supported Bands

- If you plan on changing cellular carriers, ensure that your modem supports the necessary bands. Supported bands listed below:

Bands	Category 4 Modem	Category 6 Modem
	Quectel EC25-AF	Quectel EP06-A
	2 / 4 / 5 / 12 / 13 / 14 / 66 / 71	2 / 4 / 5 / 7 / 12 / 13 / 25 / 26 / 29 / 30 / 66

ACTIVATION CONTACT INFORMATION

CARRIER	CONSUMER PHONE	BUSINESS PHONE	WEBSITE
AT&T	888.333.6651	888.444.4410	att.wifiranger.com
VERIZON	**Official Support Coming Soon (we cannot guarantee Verizon data plans at this time)*		
MILLENICOM	800.996.1285	800.996.1285	millenicom.wifiranger.com

LTE Setup

ACCESSING CELLULAR SETTINGS

- Power up the WiFiRanger system with embedded LTE modem(s).
- Connect over ethernet or wirelessly to the WiFiRanger's network.
- Access Control Panel of the WiFiRanger and select the "Setup" tab.
- Expand modem settings by clicking the appropriate gear icon:
 - Standalone WiFiRanger (indoor or outdoor unit):
 - Click "Cellular" gear icon.
 - Pack WiFiRangers (indoor and outdoor units):
 - Click "Cellular" gear icon to access indoor unit modem.
 - Click "WFRControl" gear icon to access outdoor unit modem.

VIEWING SIM & IMEI NUMBERS

If you need the SIM or IMEI numbers for Cellular plan activation or support, then follow the steps below:

- Follow steps for "Accessing Cellular Settings."
- View SIM & IMEI numbers after expanding the modem settings.

Converge Routers & Modems Only Support Standard SIM Size. Be sure that SIM card is Standard size as Nano and Micro sizes will not fit properly within Converge routers or LTE modems. A SIM card size adapter kit may be used to resize the SIM.



REFRESHING SIM NUMBER

If you've changed the SIM card in your WiFiRanger modem and need to refresh the SIM number, follow the steps below:

- Follow steps for "Accessing Cellular Settings."
- Click on "Clear SIM Details" then wait 30 seconds.
- Click on "Reboot Cellular" then wait 60 seconds.
- Reload the Control Panel and verify the new SIM number appears.

MANUALLY SETTING AN APN

(This is usually unnecessary on latest firmware since APN is automatically detected.) If you are unable to connect to the internet using the WiFiRanger modem even though your data plan is active, then there may be an issue with the modem's APN. An APN is a password used by the modem for authenticating with your cellular Carrier. To change the APN, follow the steps below:

1. Follow steps for "Accessing Cellular Settings."
2. Enter correct APN into the APN field:
 - Default APN shown in this table (most common)

Carrier	Default APN
Verizon	vzwinternet
AT&T	broadband
T-Mobile / Millenicom	fast.t-mobile.com

- Unique APN on your Cellular account (only if applicable)
3. Click "Save Changes."

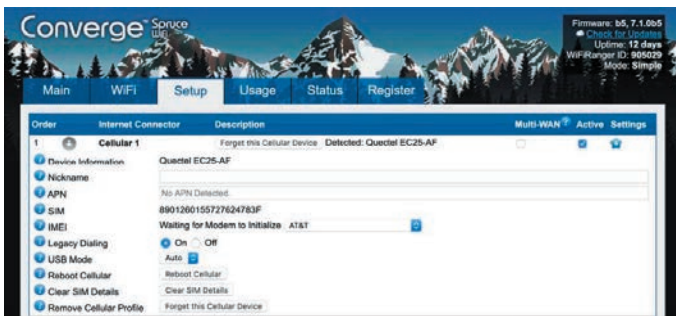

Source(s): WiFi Ranger Convergence Indoor/Outdoor Routers Owners Manual (2020)
 Product(s): This source is associated with more than one product. Refer to Newgle for more information about the product(s) offered for your coach's model year.

This page is intentionally blank.



ENTERTAINMENT SYSTEMS

This chapter provides information on entertainment components, including televisions, dash-mounted audio equipment, multi-disc players, home theater systems, and satellite antennas. Such components may be located within your coach's living room, bedroom, cargo area, or even outside the coach in an optional exterior entertainment center.

⚠ IMPORTANT

Any of the following quick start instructions provided by Newmar should not take the place of the manufacturer's complete documentation. Refer to Newgle for more information about entertainment components offered for your coach's model year.



Antennas, Cable, and Satellite Systems

Antennas and Cable Overview

This article provides an overview of the antenna and cable system in the coach. Your coach may be equipped with an exterior antenna jack and interior antenna jacks or wiring at each television location. Depending on your coach year, model, and options, several antennas have been used.

Antenna Power Booster

An antenna with a power booster may be installed in your coach and is designed for reception of all local color and black-and-white channels. The antenna may be automatic, stationary, or manual lift. The power booster supplies voltage to the antenna when using over-the-air signal. However, it transfers the connection from the antenna to park cable when it is available and connected.

To operate the power booster for the television signal, press the switch on the booster plate to illuminate the green LED light. This will supply power to the antenna and boost the television signal.

When using park cable, the booster must be turned off to allow the signal to bypass the antenna and connect to the television or selector switch through the same coax cable. The green LED light should not be illuminated.

A 12 volt outlet is also provided for 12 volt accessories. Do not use this outlet for a cigarette lighter.

Over-The-Air Signal

If the reception is poor, make sure the power switch for the power booster is in the "ON" position and all of the coax connections are tight. This switch is usually located beside the passenger chair or on the video selector box (select units only).

On coaches with a Rayzar automatic TV antenna, this switch is integrated into the power on/off switch typically located in the overhead control center. After traveling, it may be necessary to auto-program your televisions to pick up local stations.

Cable Connection

An exterior cable jack and receptacle may be available on your coach. If installed, they may be located in an outside storage compartment, usually near the power cord.

When using park cable, it is necessary to turn the antenna booster off in order to allow the signal to travel to the television or selector switch (if equipped). This switch is usually located beside the passenger chair; it can also be the power button on the video selector box (select units only).

On coaches with a Rayzar automatic TV antenna, this switch is integrated into the power on/off switch typically located in the overhead control center.

⚠ IMPORTANT

Failure to turn off the power booster switch to the antenna while using the park cable system may cause poor picture quality.



Antenna Power Booster

Cable Connection with Optional Tripod Satellite Connections

Winegard Rayzar Antenna

Basic Troubleshooting

If you have poor reception, try these simple solutions:

1. Make sure the power booster or Rayzar antenna system is turned off.

2. Make sure the coax cable from the park cable hookup to the basement of the coach is in good, working condition and does not have a shorted shield wire.

3. Each TV will need to be set for cable and auto programmed at each new campsite location.
4. Any further troubleshooting and diagnosis should be performed by an authorized service technician.

Winegard Rayzar Automatic Antenna Operation (Models: RZ-7500, RZ-7535, RZ-8500, RZ-8535)

This article provides information about the control panel, cable and antenna mode, and the automatic search function of a Winegard Rayzar Automatic Antenna (Models: RZ-7500, RZ-7535, RZ-8500, RZ-8535).

Control Panel

Coaches equipped with a Rayzar Automatic Antenna will also be equipped with a control panel in the overhead cabinet.

Cable Mode

When the control panel is powered off, park cable signals will be passed to the TV. In this mode all LEDs are turned off.

Antenna Mode

When the Control panel is powered on by pressing the On/Off button, the LEDs will flash and begin its power on process. At this time the antenna amplifier is powered on and TV antenna signals will be passed. Initially, GREEN "Positional LED(s)" will be lit to indicate the direction the antenna is positioned.



Automatic Search Function

The system does not move until the Search button is pressed. Channels will be received whenever the system is powered on.

To begin a new search, press the Search button. The antenna will go through its initialization process and begin searching for TV frequencies. A typical search will take 2-3 minutes. A RED LED will quickly cycle through the positional LED position to indicate the antenna is moving and direction it is moving. After the search is complete, the antenna will automatically go to the position which results in the most watchable TV channels. The 2-digit display will show the number of frequencies seen at that position, and both the GREEN and RED LED(s) will be lit to indicate the successful search location.

Additional RED LEDs will also light to show any other channels found at alternate positions. Pressing the Search button again will move the antenna to the next best location. Continuing to press Search again will cycle through other positions that provided additional channels, until returning to the main search location. To clear search results and initiate a new search, press and hold the Search button for 2 seconds. The system will also clear all search results each time it is powered off.

Source(s): Winegard Rayzar Automatic Antenna User Guide

Product(s): This source is associated with more than one product. Refer to Newgle for more information about the product(s) offered for your coach's model year.

Winegard Sensar Manual Antenna Operation

This article provides instructions for raising, lowering, and rotating the Winegard Sensar Manual Antenna, as well as information about the booster switch and cable mode.

Newmar is currently using Winegard antennas. Depending on your coach model, year, and available options, your coach may be equipped with either a manual or an automatic TV antenna.

Operation

RAISING THE ANTENNA

Turn elevating crank (clockwise) in "UP" direction about 13 turns or until some resistance to turning is noted. AMPLIFIED MODELS ONLY Turn power supply ON to use either front or rear TV outlet. Neither outlet will work unless power supply switch is ON.



LOWERING THE ANTENNA

Rotate antenna until pointer on directional handle aligns with pointer on ceiling plate. Turn elevating crank (counter clockwise) in “DOWN” direction about 13 turns or until resistance is noted. Antenna is now locked in travel position.

CAUTION

Under no circumstances should you lower the antenna in any position except the travel position.

ROTATING THE ANTENNA FOR BEST PICTURE

Make sure antenna is in “UP” position. Pull down with both hands to disengage ceiling plate. Rotate for best picture.

Winegard RoadTrip T4 Automatic In-Motion Satellite Operation (Model: RTT-20B/RT2000T)

This article provides basic operation instructions for a Winegard RoadTrip T4 Automatic In-Motion Satellite (Model: RTT-20B/RT2000T).

Operating The Roadtrip® T4 Antenna

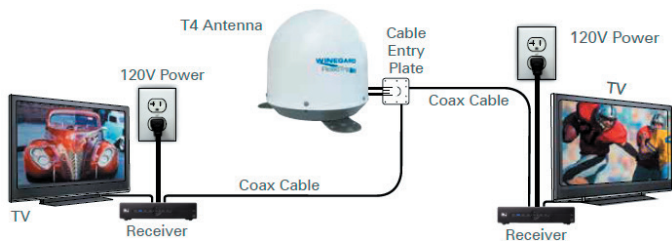

1. Turn on receiver and television set. The RoadTrip® T4 antenna must be connected to a receiver plugged into 120VAC.
2. Verify that you are getting the receiver's menu screens on the television. These screens are available with or without the dish finding the signal.
3. Ensure receiver is properly configured for your provider.
4. Turn the power switch on for the antenna. Within 10–15 seconds, the dish will begin moving and should make one or two revolutions during startup. During this process, it is normal to hear a slight grinding sound as the unit checks its rotational limits. This does not harm the unit. The system will pause to acquire GPS.
5. Once the dish begins its search, it pauses on signals long enough to determine which satellite it has found. The antenna may move off the signal in an effort to verify the signal and should return shortly.

TIP: Because the T4 antenna uses information from the last location where it was on signal, satellite acquisition may take longer if the dish is inactive over long distance traveling.

Booster Switch

On coaches equipped with a manual antenna, the booster switch is typically located beside the passenger seat on the wall near the floor (left photo).



Cable Mode

When the control panel is powered off, park cable signals will be passed to the television. In this mode, the LED indicator light is off.

Source: Winegard Sensar Antennas Installation/Operation Manual (All Models)

6. After the T4 has verified the correct satellite, it will continue to track the signal. The unit will go into “Sleep Mode” if the vehicle is stationary for 6 minutes. This involves a quick verification process where signal may be lost, then return to the signal and be silent. If the vehicle begins moving greater than 10 MPH, the in-motion T4 will resume tracking mode. For smoother operation, use your on-screen guide to locate your channel rather than “channel surfing.”
- NOTE There are certain areas within the U.S. where the T4 antenna may experience limited or no coverage of the 129° satellite for HD programming. DISH home coverage has the same limitations. Problem areas include Washington, Oregon and California, but limited coverage may extend past these areas. Contact DISH for additional coverage questions (1-888-825-2557).
 - ALSO when the T4 dome is blocked (example: while going through a tunnel, under a bridge, by a building, etc.) programming will not be available. Once the block is removed, the programming will return.

DirecTV®

The RoadTrip® T4 antenna switch settings are preset for DIRECTV. If you have a DISH or Bell TV receiver, you must change the numbered switches found on the electronics box under the dome.

RECEIVER SETUP

Connect the receiver to a power source, and complete receiver setup. Check out online receiver setup guides for your antenna at www.winegard.com/support.

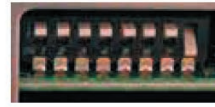

(factory preset for DIRECTV)

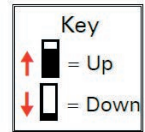

RECEIVER RECOMMENDATIONS

The RoadTrip® T4 antenna will operate with most DIRECTV receivers. Winegard does not recommend using receivers with hard drives, as they are not intended for mobile applications. Winegard does not recommend using an HD receiver since HD programming will not be available. SWM only receivers require a SWM-840 kit.

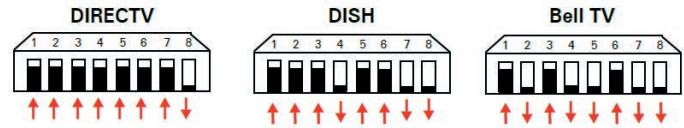

SATELLITE COVERAGE

The antenna will locate and toggle between satellites 101° and 119°. The RoadTrip® T4 antenna will not operate in all areas where satellites 101° and 119° are available. The T4 antenna is not compatible with 110° or KA-band satellites 99° and 103°. Satellite coverage maps are based on level, stationary operation. Reception interruption may also occur during adverse weather conditions.

Maintenance

The RoadTrip® T4 antenna is designed to be maintenance free. However, it is a good idea to clean the dome from time to time with a soft cloth, water, and dish soap.

Source(s): Winegard RoadTrip T4 Automatic In-Motion Roof-Mounted Satellite TV Antenna User Guide

Product(s): Winegard T4 RoadTrip In-Motion Satellite (Model: RTT-20B, Newmar Part Number: 135606P)

Winegard RoadTrip P4 Automatic Stationary Satellite Operation (Model: RTS-20B)

This article provides basic operation instructions for a Winegard RoadTrip P4 Automatic Stationary Satellite (Model: RTS-20B).

Operating The Roadtrip® P4 Antenna

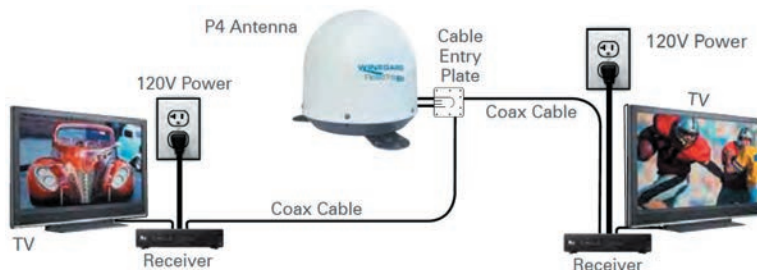

1. Turn on receiver and television set. The RoadTrip® P4 antenna must be connected to a receiver plugged into 120VAC.
 2. Verify that you are getting the receiver's menu screens on the television. These screens are available with or without the dish finding the signal.
 3. Ensure receiver is properly configured for your provider.
 4. Turn the power switch on for the antenna. Within 10–15 seconds, the dish will begin moving and should make one or two revolutions during startup. During this process, it is normal to hear a slight grinding sound as the unit checks its rotational limits. This does not harm the unit. The system will pause to acquire GPS.
 5. Once the dish begins its search, it pauses on signals long enough to determine which satellite it has found. The antenna may move off the signal in an effort to verify the signal and should return shortly.
- TIP: Because the P4 antenna uses information from the last location where it was on signal, satellite acquisition may take longer if the dish is inactive over long distance traveling.
 - NOTE There are certain areas within the U.S. where the P4 antenna may experience limited or no coverage of the 129° satellite for HD programming. DISH home coverage has the same limitations. Problem areas include Washington, Oregon and California, but limited coverage may extend past these areas. Contact DISH for additional coverage questions (1-888-825-2557).
 - ALSO when the P4 dome is blocked (example: while going through a tunnel, under a bridge, by a building, etc.) programming will not be available. Once the block is removed, the programming will return.

DirectTV®

The RoadTrip® P4 antenna switch settings are preset for DIRECTV. If you have a DISH or Bell TV receiver, you must change the numbered switches found on the electronics box under the dome.

RECEIVER SETUP

Connect the receiver to a power source, and complete receiver setup. Check out online receiver setup guides for your antenna at www.winegard.com/support.

RECEIVER RECOMMENDATIONS

The RoadTrip® P4 antenna will operate with most DIRECTV receivers. Winegard does not recommend using receivers with hard drives, as they are not intended for mobile applications. Winegard does not recommend using an HD receiver since HD programming will not be available. SWM only receivers require a SWM-840 kit.

SATELLITE COVERAGE

The antenna will locate and toggle between satellites 101° and 119°. The RoadTrip® P4 antenna will not operate in all areas where satellites 101° and 119° are available. The P4 antenna is not compatible with 110° or KA-band satellites 99° and 103°. Satellite coverage maps are based on level, stationary operation. Reception interruption may also occur during adverse weather conditions.

Winegard Trav'ler Automatic Multi-Satellite TV Antenna Operation (Models: SK-773, SKM-100, SWM-300)

This article provides basic operation instructions for a Winegard Trav'ler Automatic Multi-Satellite TV Antenna (Models: SK-773, SKM-100, SWM-300).

Operation

The TRAV'LER antenna offers a simple one-button operation. Simply press "POWER," and the antenna will automatically begin searching for satellites. The instructions assume that the antenna is already in the stowed position.

1. Press and hold "POWER" for two seconds or until the TRAV'LER interface displays "POWER ON."
2. Once the unit has been powered on, release "POWER."
3. The interface screen will display the type of satellite dish on the top line.
4. The TRAV'LER antenna will enter the search mode as part of its normal operation and will display "Searching" on the bottom line.
5. The antenna will find its home position and begin to look for a satellite. Upon finding a satellite, the antenna will fine-tune or "peak" on the signal.
6. In automatic search mode, the TRAV'LER antenna will lock onto multiple different satellites. The antenna will display an asterisk for each satellite found.



(factory preset for DIRECTV)

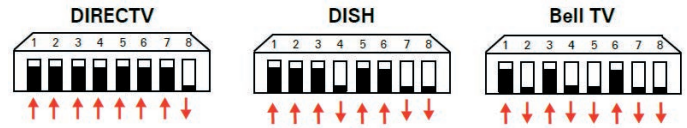
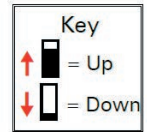

Maintenance

The RoadTrip® P4 antenna is designed to be maintenance free. However, it is a good idea to clean the dome from time to time with a soft cloth, water, and dish soap.

Source(s): Winegard RoadTrip P4 Automatic Stationary Roof-Mounted Satellite TV Antenna

Product(s): Winegard RoadTrip Automatic Stationary Roof-Mounted Satellite TV Antenna (Model: RTS-20B, Newmar Part Number: 135607)

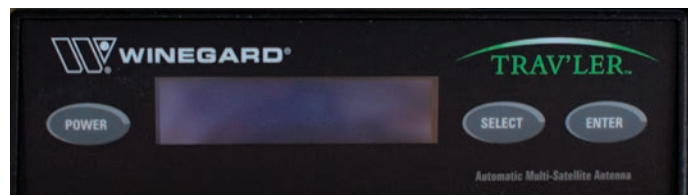

TIP: If you want to turn off the power to the TRAV'LER antenna after the antenna has locked onto satellites, press "POWER" and "SELECT" at the same time. Before traveling, make sure to press "POWER" and wait for the antenna to start to power up; then press "POWER" again to initiate the stow sequence.

TRAV'LER SK-SWM3 SATELLITE ANTENNA

- DIRECTV Satellites: 99°, 101°, 103°
- Views 3 Satellites Simultaneously

TRAV'LER SK-1000 SATELLITE ANTENNA

- DISH Satellites: 110°, 119°, 129° (61.5° Manual Only)
- Views 3 Satellites Simultaneously
- Bell TV Satellites: 82°, 91°

TRAV'LER SK-7003 SATELLITE ANTENNA MOUNT

- Shaw Direct Satellites: 107°, 111°
- Views 3 Satellites Simultaneously

User Menu For Manual Operation

The interface includes a user menu for some advanced features. The options most commonly used are the ability to change the dish type, check software/hardware versions, change desired satellite configuration, or manually move the dish.

⚠ WARNING

Improper use of the user menu could cause damage to the TRAV'LER antenna and/or vehicle. Do not enter the user menu for regular operation.

Ready To Travel?

The TRAV'LER antenna is not meant for use while traveling. To stow the unit when you are ready to travel, press "POWER" one time. The unit will stop what it is doing and return to the stowed position. The TRAV'LER interface will not turn off unless the TRAV'LER antenna is successfully stowed. Visually inspect that the antenna is in the stowed/ travel position before traveling. Do not move the vehicle until the TRAV'LER antenna is stowed.

Emergency Manual Stow

If unable to stow the TRAV'LER antenna, it may be necessary to use emergency manual stow. Emergency manual stow is meant as a last resort and is not meant for common usage! To use emergency manual stow, unplug the interface box. Then, remove the black plastic bolt from the back of the mount. Insert a 5/16" socket extension into this auxiliary drive. Turn the auxiliary drive clockwise to lower the unit. Do not use a drill!

Emergency Power Off

The antenna comes with an emergency power off feature. To activate it, press and hold "POWER" and then press "SELECT" while still holding "POWER". The TRAV'LER antenna will stop and turn off. If the emergency power off feature is used, the antenna may not be in a safe position for travel. Do not move the vehicle until the unit is stowed.

Source(s): Winegard Trav'ler Antenna DIRECTV SK-SWM3

Product(s): This source is associated with more than one product. Refer to Newgle for more information about the product(s) offered for your coach's model year.

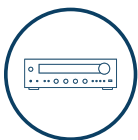

Audio Systems

Bose TV Speaker Operation (Model: 838309-1100)

This article provides basic operation instructions for a Bose TV Speaker (Model: 838309-1100).

Remote Control

POWER

On the remote, press the Power button to power the speaker on/off. When powered on, the speaker defaults to the last active source.

- When you plug the speaker into an AC (mains) outlet, the speaker automatically powers on.
- The first time the speaker is powered on, the speaker defaults to the TV source.
- If the speaker is connected to the TV using an HDMI cable, the speaker changes to the TV source whenever the TV is powered on.

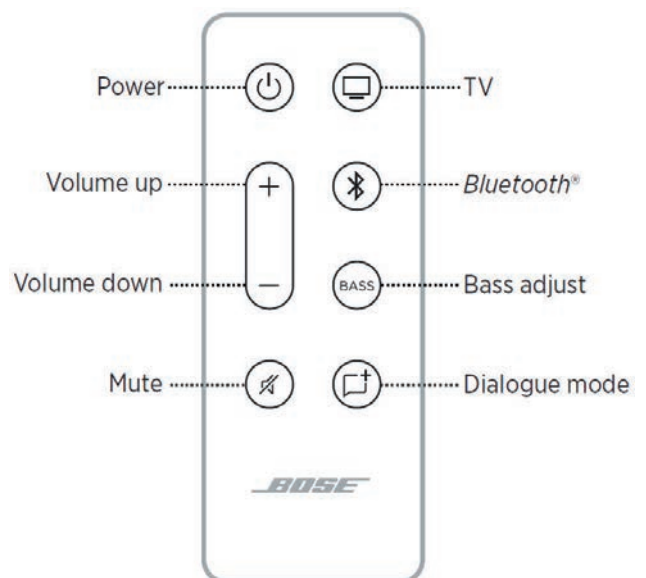

AUTO-WAKE

You can set the speaker to power on whenever a sound signal is received from an optical or analog cable. On the remote press and hold the Power button I until you hear a tone and the TV and Bluetooth lights on the speaker blink amber 3 times to switch between auto-wake and default power settings.

VOLUME

Volume Up: Press +. NOTE: To quickly increase the volume, press and hold +.

Volume Down: Press -. NOTE: To quickly decrease the volume, press and hold -.

Mute/Unmute: Press the Mute button. When audio is muted, the light on the speaker of the current source (TV or Bluetooth) pulses white until audio resumes. TIP: You can also press + to resume audio.

SOURCES

You can control your TV and Bluetooth connections using your remote. To control a source, press the TV button or Bluetooth button) on the remote for the source you want to control.

DIALOGUE MODE

Dialogue mode improves the clarity of dialogue and vocals in movies, TV programs, and podcasts by adjusting the audio balance of the system. On the remote, press the Dialogue mode button to switch between Dialogue mode and your default audio settings. When Dialogue mode is enabled, the light for the current source glows green.

Note: When you enable Dialogue mode, it stays enabled for your current source even if you switch to another source or turn off the speaker. To disable Dialogue mode for a source, press the Dialogue mode button again.

ADJUST THE BASS

1. On the remote, press BASS. On the speaker, the TV and Bluetooth lights blink white 3 times.
2. Adjust the bass by doing one of the following:
 - Press Volume up (+) to increase the bass.
 - Press Volume down (-) to decrease the bass.

The TV and Bluetooth lights on the speaker glow to show the current bass setting.

3. Press BASS. The speaker saves the current bass setting.

RESET THE BASS

On the remote, press and hold BASS until the TV and Bluetooth lights on the speaker blink 3 times. The bass settings reset to original factory settings.

BLUETOOTH

1. On the remote, press the Bluetooth button. The Bluetooth light slowly pulses blue.
2. On your mobile device, enable the Bluetooth feature. TIP: The Bluetooth menu is usually found in the Settings menu.
3. Select Bose TV Speaker from the device list. Once connected, you hear a tone. The Bluetooth light glows solid white. Bose TV Speaker appears in the mobile device list.

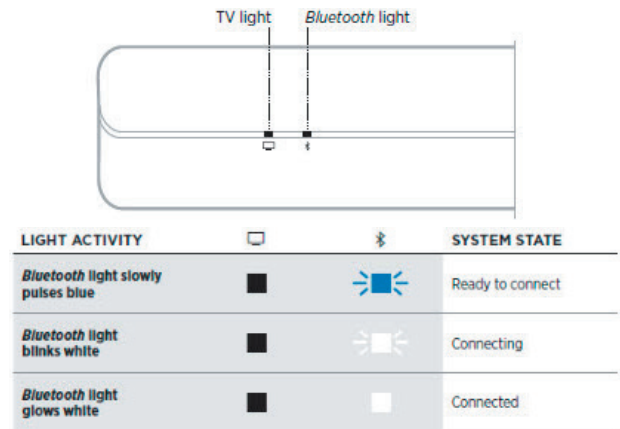

SPEAKER STATUS

The LED lights located on the front of speaker show the speaker status. The lights display the current sources highest priority status.

LIGHT ACTIVITY	SYSTEM STATE
TV light is solid white	Power on TV
Bluetooth light is solid white	Connected to a Bluetooth device
TV light is solid green	Dialogue mode enabled for TV
Bluetooth light is solid green	Dialogue mode enabled for Bluetooth-connected device
TV light blinks white	Changing volume for TV
Bluetooth light blinks white	Changing volume for Bluetooth-connected device
TV light blinks green	Changing volume in Dialogue mode for TV
Bluetooth light blinks green	Changing volume in Dialogue mode for Bluetooth-connected device
TV light slowly pulses white	Mute enabled for TV
Bluetooth light slowly pulses white	Mute enabled for Bluetooth-connected device
TV light slowly pulses green	Mute enabled in Dialogue mode for TV
Bluetooth light slowly pulses green	Mute enabled in Dialogue mode for Bluetooth-connected device
TV light blinks red	Speaker error - disconnect from power then reconnect. If error persists, contact Bose customer service.

Source(s): Bose TV Speaker Start Guide

Product(s): Bose TV Speaker (Model: 838309-1100, Newmar Part Number: 155172)

Sony Bluetooth Audio System Operation (Model: WX-920BT)

This article provides basic operation instructions for a Sony Bluetooth Audio System (Model: WX-920BT).

Control Panel and Remote Operation

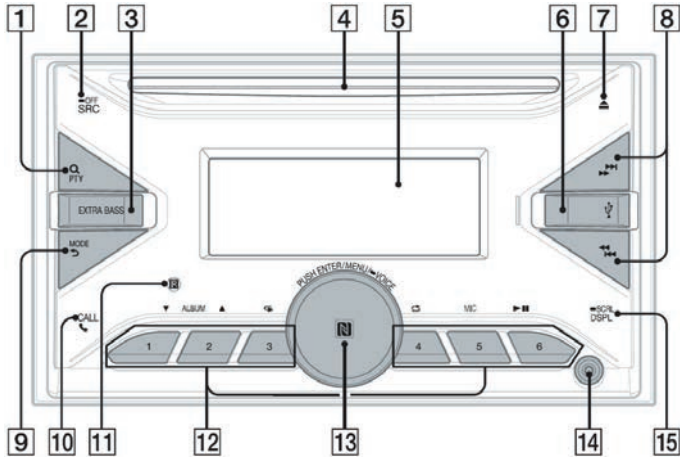

1. Browse: Enter the browse mode during playback (not available when a USB device in Android mode or iPod is connected).
2. Source (SRC/OFF): Turn on the power. Change the source. Press and hold for 1 second to turn the source off and display the clock. Press and hold for more than 2 seconds to turn off the power and the display. If the unit is turned off and the display disappears, operation by the remote commander is not available.
3. Extra Bass: enforces bass sound in synchronization with the volume level. Press to change the EXTRA BASS setting: [1], [2], [OFF].
4. Disc Slot
5. Display Window
6. USB Port
7. Disc Eject
8. SEEK (◀◀/▶▶, ◀▶/▶▶): Tune in radio stations automatically. Press and hold to tune manually.
9. MODE/BACK: Return to the previous display.
10. CALL: Enter the call menu. Receive/end a call. Press and hold more than 2 seconds to switch to Bluetooth signal.
11. Receptor for the remote commander

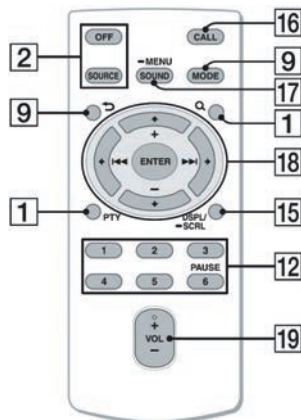

12. Number Buttons (1-6): Receive stored radio stations. Press and hold to store stations.
 - ALBUM (▲/▼): Skip an album for audio device. Press and hold to skip albums continuously. (Not available when a USB device in Android mode or iPod is connected.) Press ▲ to thumbs up, or ▼ to thumbs down in Pandora®.
 - REPEAT: (Not available when a USB device in Android mode is connected.)
 - Shuffle: (Not available when a USB device in Android mode is connected.)
 - MIC
 - Play/Pause (▶||)
13. Control Dial: Rotate to adjust the volume.
 - Push Enter: Enter the selected item. Press SRC, rotate then press to change the source (timeout in 2 seconds).
 - Menu: Open the setup menu.
 - Voice: Press and hold for more than 2 seconds to activate voice dial, voice recognition (Android smartphone only), or the Siri function (iPhone only).
 - N-Mark: Touch the control dial with Android smartphone to make Bluetooth connection.
14. AUX input jack
15. DSPL (Display) Press to change display items.
 - SCRL (Scroll): Press and hold to scroll a display item.
16. CALL: Enter the call menu; receive/end a call.
17. SOUND: Open the SOUND menu directly.
 - MENU: Press and hold to open the setup menu.
18. ARROWS (◀, ▲, ▼, ▶): Select a setup item, etc.
 - ENTER: Enter the selected item. Press and hold for more than 2 seconds to establish or terminate the “Sony | Music Center” function.
 - PREV/NEXT (◀◀/▶▶)
 - ALBUM (+/-)
19. VOLUME (+/-)

Resetting The Unit

Before operating the unit for the first time, after replacing coach batteries, if the coach batteries were depleted, or changing if the connections, you must reset the unit. Press DSPL and CALL simultaneously for more than 2 seconds.

Note: Resetting the unit will erase the clock setting and some stored contents.

Setting The Clock

1. Press MENU, rotate the control dial to select [GENERAL], then press it.
2. Rotate the control dial to select [CLOCK ADJ], then press it. The hour indication flashes.
3. Rotate the control dial to set the hour and minute. To move the digital indication, press ◀◀ / ▶▶ (SEEK -/+).
4. After setting the minute, press MENU. The setup is complete and the clock starts. To display the clock Press DSPL.

Preparing A Bluetooth Device

You can enjoy music, or perform hands-free calling depending on the BLUETOOTH compatible device such as a smartphone, cellular phone and audio device (hereafter “BLUETOOTH device” if not otherwise specified). For details on connecting, refer to the Sony Bluetooth Audio System WX-920BT Operating Instructions.

Listening To The Radio

To listen to the radio, press SRC to select [TUNER].

TUNING

1. Press MODE to change the band (FM1, FM2, FM3, AM1 or AM2).
2. Perform tuning.
 - To tune manually, press and hold ◀◀ / ▶▶ (SEEK -/+) to locate the approximate frequency, then press ◀◀ / ▶▶ (SEEK -/+) repeatedly to fine adjust to the desired frequency.
 - To tune automatically, press ◀◀ / ▶▶ (SEEK -/+). Scanning stops when the unit receives a station.

STORING MANUALLY

While receiving the station that you want to store, press and hold a number button (1 to 6) until [MEMORY] appears.

RECEIVING THE STORED STATIONS

Select the band, then press a number button (1 to 6).

Playing A Disc

1. Insert the disc (label side up). Playback starts automatically.

Playing A USB Device

1. Connect a USB device to the USB port. Playback starts. If a device is already connected, to start playback, press SRC to select [USB] ([the source] appears in the display when the it is recognized).
2. Adjust the volume on this unit. To stop playback, press and hold OFF for 1 second. To remove the device, stop playback, then remove the device.

CAUTION

iPhone ONLY: When you connect an iPhone via USB, phone call volume is controlled by the iPhone, not the unit. Do not inadvertently increase the volume on the unit during a call, as a sudden loud sound may result when the call ends.

Playing A Bluetooth Device

You can play contents on a connected device that supports BLUETOOTH A2DP (Advanced Audio Distribution Profile).

1. Make BLUETOOTH connection with the audio device. To select the audio device, press MENU, then select [BLUETOOTH] → [AUDIO DEV].
2. Press SRC to select [BT AUDIO].
3. Operate the audio device to start playback.
4. Adjust the volume on this unit.

Source(s): Sony Bluetooth Audio System WX-920BT Operating Instructions

Product(s): Sony Compact Disc Receiver w/Bluetooth (Model: WX-920BT, Newmar Part Number: 147972)



Televisions

This article provides an overview of the televisions and related equipment installed in the coach. Your coach may be cable ready, and (depending on your floorplan) may have multiple flat screen televisions installed throughout the unit. The televisions are powered by 120 volt electricity, and the coach must be plugged into shore power, using the inverter (if equipped) or have the generator running in order for the televisions to function. The television operation is similar to most televisions used in the home.

The LED television(s) in your coach may be HD (High Definition) compatible, meaning they are capable of displaying the resolution and clarity of High Definition broadcasts and video sources.

Your coach may also be pre-wired for a satellite system and may be equipped with one interior television jack and an exterior television jack located on the passenger side of the coach. Choose the television source by selecting the input mode (air, cable, HDMI, etc.). The DVD player and satellite, if equipped, provides input to the front television(s) and exterior entertainment center. The bedroom DVD and satellite receiver, if equipped, provides input to the bedroom television.

Note: 2022 and newer models may not be equipped with DVD or Blu-Ray players installed at the factory.

⚠ IMPORTANT

The television in the front overhead cabinet will not operate while in transit. Federal regulations require this television to be inoperative while the vehicle is in use, so the power supply is switched off automatically when the ignition is turned on.

Exterior Entertainment Center with Samsung Television

This article provides a basic overview of the exterior entertainment center. For your convenience and pleasure, an Exterior Entertainment Center may be an option on selected floorplans. It may be located in either a basement compartment or in the sidewall of the passenger side of the coach and features a flat screen television.

Television

The television is mounted on a swivel bracket that allows you to swing the television out and away from the coach to provide better viewing angles. To release the television from its retainers, grasp the sides of the television firmly and pull it directly toward you. It will release and swing freely to the desired viewing position. To store the television for travel, swing it back into the opening, making sure that it is fully latched.

⚠ IMPORTANT

It is important to make sure the TV is securely locked into position prior to closing the compartment door. Failure to do so can result in damage to the television case and screen.



Soundbar Operation In Conjunction with Xite Radio

Depending on the year, model, and floorplan of your coach, this entertainment center may also feature a soundbar that will play whatever source is selected from the television when it is turned on (i.e. park cable, blu-ray player, satellite). While using the exterior television, the radio cannot be played through the soundbar.

The radio may be played through the soundbar via the Xite radio's House Mode feature; however, the exterior television must be turned off. To play media through the soundbar using a separate device such as iPad, smartphone, etc., press the Bluetooth button on the soundbar and pair it with the desired device. For more information about the Bluetooth functionality, refer to the owner's manual for your specific soundbar, which can be located in Newgle.

⚠ IMPORTANT

The electronics used in the Exterior Entertainment Center are not designed for use in wet weather. The TV should be stored securely in the "travel" position and the basement door closed during rain or other adverse weather conditions. Caution should also be exercised when washing the exterior of your coach to make sure high pressure water does not enter the compartment. Spraying high pressure water at the seal between the doors can cause leaks, and potentially damage the electronics housed in this compartment.

Samsung 4K UHD 6 Series Television Operation (Models: M4500, NU6900B, and NU7100)

This article provides basic operation instructions for a Samsung 4K UHD 6 Series Television (Models: M4500, NU6900B, and NU7100).

Remote Control Operation

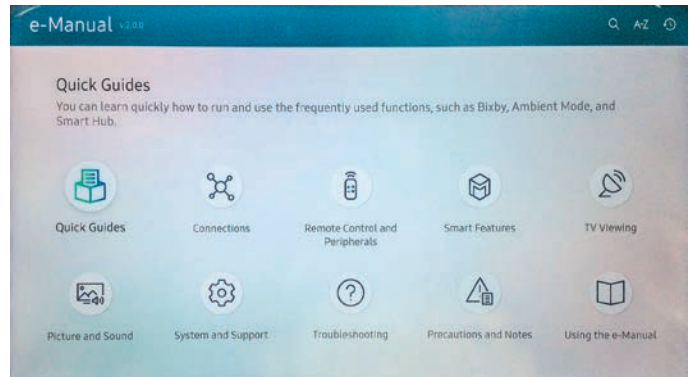
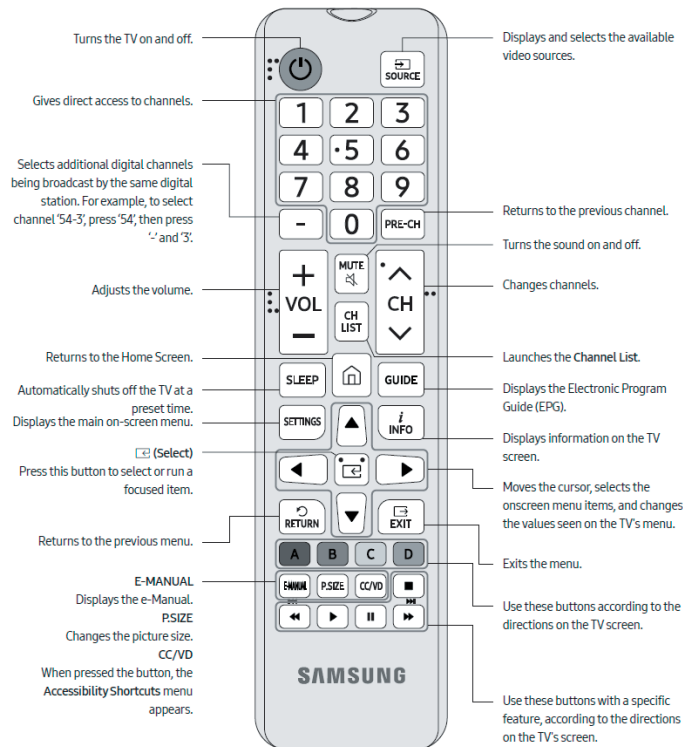

Caring for the TV

- If a sticker was attached to the TV screen, some debris can remain after you remove the sticker. Please clean the debris off before watching TV.
- The exterior and screen of the TV can get scratched during cleaning. Be sure to wipe the exterior and screen carefully using a soft cloth to prevent scratches.
- Do not spray water or any liquid directly onto the TV. Any liquid that goes into the product may cause a failure, fire, or electric shock.
- To clean the screen, turn off the TV, then gently wipe away smudges and fingerprints on the panel with a micro-fiber cloth. Clean the body or panel of the TV with a micro-fiber cloth dampened with a small amount of water. After that, remove the moisture with a dry cloth. While cleaning, do not apply strong force to the surface of the panel because it can damage the panel. Never use flammable liquids (benzene, thinner, etc.) or a cleaning agent. For stubborn smudges, spray a small amount of screen cleaner on a micro-fiber cloth, and then use the cloth to wipe away the smudges.

Accessing Samsung's E-Manual

You can view the embedded e-Manual containing information about your TV's key features. Press the menu button on the standard remote control to open the menu. Alternatively, press the button to open Smart Hub, press the left arrow until you reach settings, and then press Select.

Use the up and down arrows to move within this menu. Move to the Support option, select the e-Manual option, and then press Select to open it. The e-Manual contains two rows of buttons. Use the up and down arrows to move between rows and the left and right arrows to move within a row. Press Select to open the section you want to read.

IMPORTANT

The Samsung e-Manual may contain features not applicable to your television.

Source(s): Samsung 2018 UHD TV NU6900 User Manual, Samsung 2018 UHD TV NU7100 User Manual, and Samsung 2017 LED Smart TV M4500 User Manual

Product(s): This source is associated with more than one product. Refer to Newgle for more information about the product(s) offered for your coach's model year.

Samsung 4K UHD 7 Series Television Operation (Model: TU7000)

This article provides basic operation instructions for a Samsung 4K Crystal UHD 7 Series Television (Model: TU7000).

Remote Control Operation

ABOUT THE BUTTONS ON THE REMOTE CONTROL

- The images, buttons, and functions of the remote control may differ depending on the model.
- The remote control has Braille points on the Power, Channel, Volume, and Select buttons and can be used by visually impaired persons.
- If you use the remote control that comes with your TV to control another TV, some functions may not operate normally.

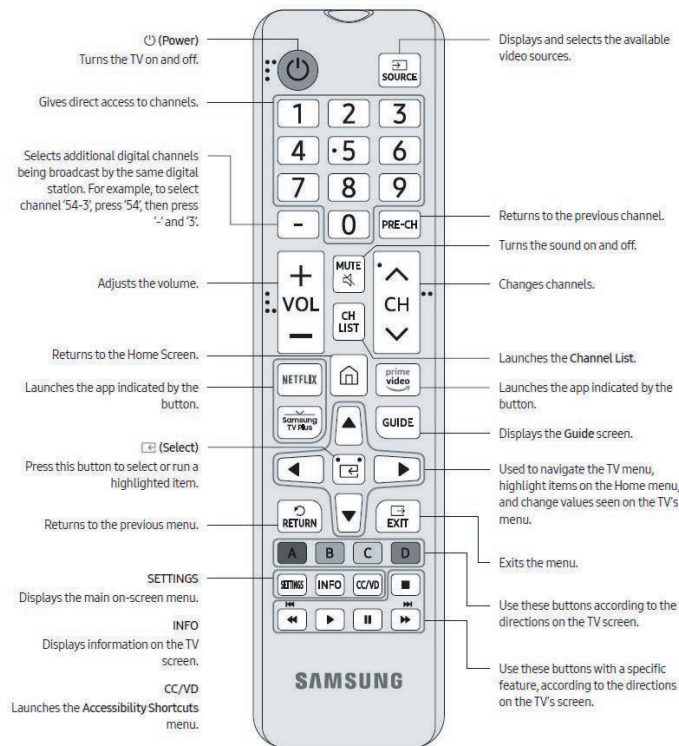

INSTALLING BATTERIES INTO THE REMOTE CONTROL

Match the polarity of the batteries to the symbols in the battery compartment.

- Use the remote control within 23 feet (7 m) of the TV.
- Bright light may affect the performance of the remote control. Avoid using near bright fluorescent lights or neon signs.
- The color and shape of the remote may vary depending on the model.

Accessing Samsung's E-Manual

You can view the embedded e-Manual containing information about your TV's key features. Press the menu button on the standard remote control to open the menu. Alternatively, press the button to open Smart Hub, press the left arrow until you reach settings, and then press Select.

Use the up and down arrows to move within this menu. Move to the Support option, select the e-Manual option, and then press Select to open it.

The e-Manual contains two rows of buttons. Use the up and down arrows to move between rows and the left and right arrows to move within a row. Press Select to open the section you want to read.

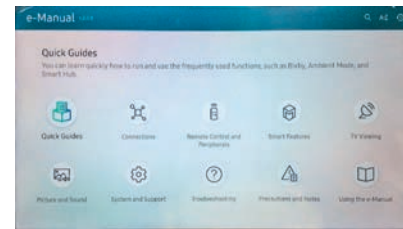

⚠ IMPORTANT

The Samsung e-Manual may contain features not applicable to your television.

Caring for the TV

- If a sticker was attached to the TV screen, some debris can remain after you remove the sticker. Please clean the debris off before watching TV.
- The exterior and screen of the TV can get scratched during cleaning. Be sure to wipe the exterior and screen carefully using a soft cloth to prevent scratches.
- Do not spray water or any liquid directly onto the TV. Any liquid that goes into the product may cause a failure, fire, or electric shock.
- To clean the screen, turn off the TV, then gently wipe away smudges and fingerprints on the panel with a micro-fiber cloth. Clean the body or panel of the TV with a micro-fiber cloth dampened with a small amount of water. After that, remove the moisture with a dry cloth. While cleaning, do not apply strong force to the surface of the panel because it can damage the panel. Never use flammable liquids (benzene, thinner, etc.) or a cleaning agent. For stubborn smudges, spray a small amount of screen cleaner on a micro-fiber cloth, and then use the cloth to wipe away the smudges.

Source(s): Samsung Crystal UHD 7 Series 4K Smart TV User Manual

Product(s): Samsung UHD 7 Series UN43TU7000 43-in Crystal UHD 4K Smart TV (Model: UN43TU7000 Newmar Part Number: 154965)

Samsung Air TV Programming

This article provides the basic programming instructions for Samsung Air TV.

1. If there is no signal after turning on the television, push the Home button on the remote.



3. Scroll down to "Broadcasting," and push "Select."

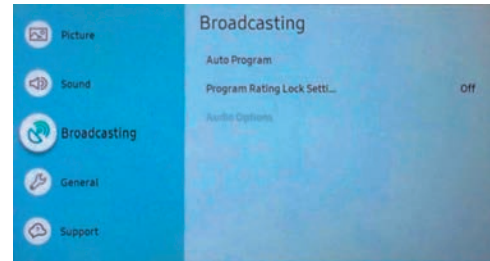

2. Use the left arrows until "Settings" appears on screen. Push "Select."

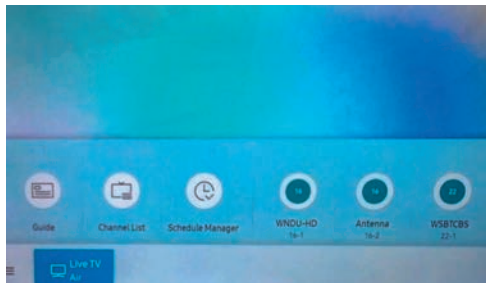

4. When "Auto Program" is highlighted, push "Select."

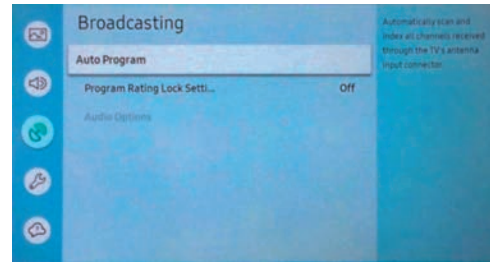

5. Highlight "Start," and push "Select." The TV will search for local channels and store them.

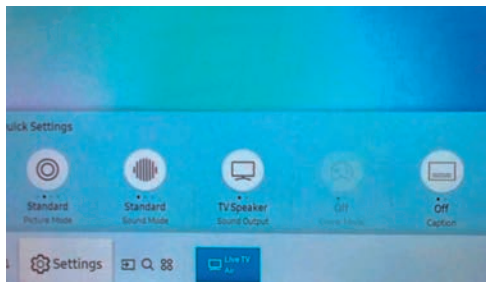
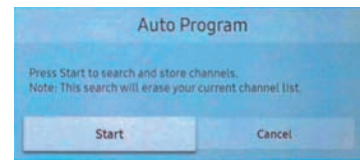

⚠ NOTICE

These steps will need to be completed each time the coach is moved to a new location.

Television Lifts

Television Lift Operation via Control Switch

This article provides basic operation instructions for a television lift (televator) via a control switch.

Operation

1. Press and release the Televator Switch to move the lift in the desired direction.
2. The lift will continue in the selected direction until it reaches the end of travel. If you need to stop it at any time during the travel process, press the switch again in either direction.



3. Under normal operation, the user will raise the televator to watch the TV, then lower it before traveling. However, when raising the televator and then immediately lowering it, the switch may need to be pressed a second time, as the control circuit timer may still be active.

⚠ NOTICE

Televator control switches and touchscreen buttons should be pressed and immediately released. Do not continue to hold the UP or DOWN switch or button, as this may cause the television lift to enter into programming mode.

Note: If programming mode is reached, refer to the recalibration article in Newgle for more information.

Televator During Travel

IMPORTANT

Lower the television lift completely for travel to prevent damage to the television and surrounding equipment.

**Lower TV
while coach
is in motion**



EXTERIOR

This chapter provides information regarding the coach's exterior components, such as awnings, compartments, doors, steps, and the overall exterior construction of the coach. If applicable to the model, this chapter also contains information for components installed in handicap-accessible coaches and toy haulers.

⚠ IMPORTANT

Any of the following quick start instructions provided by Newmar should not take the place of the manufacturer's complete documentation. Refer to Newgle for more information about exterior components offered for your coach's model year.

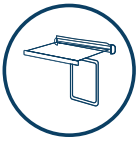

Awnings

Awnings are a standard feature on your coach. Newmar offers a variety of brands and types of awnings, depending on the year and model of your coach, as well as the available options that were selected at the time of your coach's manufacture. Select models may feature slideout toppers, entrance door, and/or window awnings.

The patio awning is the larger-sized awning on the coach and is the main awning. These awnings connect at or near the roof, providing shade, light, and rain protection on the passenger side of the coach.

The powered patio, window, and door awnings (if equipped) on your coach can be operated with ease. Use the appropriate switches to extend or retract the awnings as desired. Slideout toppers or covers operate as the slideouts are extended and retracted.

The switch is typically located in the overhead control panel. If they are not at this location, check above the passenger window, as it may be hidden by the window shade. Some coach awnings may also operate via a remote control or the SilverLeaf Virtual Keypad (if equipped).

⚠ IMPORTANT

Prior to extending any of your coach awnings, check for any obstructions that may prevent the awnings from deploying properly. Inspect the area around your unit where the awning will extend to ensure proper clearance.

⚠ CAUTION

Awnings should be retracted during accumulating rains. Pooling water on the awning can result in damage to the awning hardware and/or fabric.

NI-132

⚠ NOTICE

Damage to your awnings as a result of weather is not covered by warranty.

Carefree Patio Awning Operation via Bluetooth Wireless Control System (Model: BT12)

This article provides basic operation instructions for a Carefree Patio Awning via Bluetooth Wireless Control System (Model: BT12). The BT12 Wireless Awning Control System offers multiple methods of operating the awning, including standard switch operation, the Carefree Connects Mobile App, and the BT Remote.

Components

CONTROL SWITCHES

⚠ IMPORTANT

Illustrations show the standard Carefree switches. The switch(es) installed in the coach may vary by appearance and function.

BT MOTION SENSOR

The optional BT Motion sensor detects awning motion caused by windy conditions. The system gauges the motion of the awning's front edge (roller tube or lead rail). When the motion exceeds the preset threshold, the system retracts the awning.

The factory default is set at "3" on a scale from 1 to 5. When using the mobile app, the sensitivity can be adjusted for personal preference.



BT REMOTE

The optional BT Remote provides the ability to operate the awning from any location. The remote has an operating range of approximately 30 feet.

Additional System Features

IGNITION LOCKOUT

The BT12 Control System provides two options for transportation safety using ignition lockout.

- Standard - The system disables the extend function while the vehicle ignition key is in the ON position.
- RTL – The system fully retracts the awning and disables the extend function when the vehicle ignition key is in the ON position.

Functions will return to normal operation when the ignition key is turned OFF. Contact your vehicle dealer to find out if you have the ignition lockout option connected and which version is active in your vehicle.

LED'S

White (monotone) LEDs are a popular option providing lighting beneath the awning. Factory installed LEDs are located on the leading edge (roller tube or lead rail) or can be mounted at the awning rail when present.

The BT12 Control System provides controls to allow you to set the lights to match your preference with ON/OFF and dimming controls through the app and/or the BT Remote.

To operate the White LED lights, you must have the awning lights power switch ON. The factory default for the lights is full bright. When the light is adjusted with the BT Remote or the app, the system will remember the setting for the next time the lights are turned on.

Carefree Connects Mobile App

The app communicates directly with the Control Module.

FEATURES

- Real-time extension and retraction at the click of a button
- LED lighting control
- Adjust the rollback feature for LED positioning when the awning is extended (not available with box awnings)
- Review awning status
- Name the awning(s)
- Adjust the motion sensitivity for wind retraction (when the optional BT Motion Sensor is installed)

DOWNLOAD THE APP

The Carefree Connects Mobile App is downloadable to any device that supports:

- Current iOS or Android operating systems; and,
- Bluetooth low energy technology.

The Carefree Connects Mobile App is free to download from the App Store for Apple products or on Google Play for Android devices. Download the app. When finished, close out of your app store. Locate the BT12 icon on your Home screen. Tap on the icon to launch the app.



PAIRING

To begin controlling your awnings with the mobile app, you must first:

- Ensure Bluetooth is turned ON in the settings page for your mobile device.
- Open pairing mode on your awning.
- Pair to your awning with the mobile app.

⚠ NOTICE

Do not attempt to pair to the awning directly through your mobile device. Pairing must be done through the app.

SET THE SYSTEM INTO PAIRING MODE

To put the system into pairing mode for the mobile app and/or additional peripherals that may be added (i.e. additional remotes), follow the directions below:

1. Turn power to the awning ON.
2. Extend the awning. Note that the awning does not have to be opened completely.
3. Retract the awning.
4. When the awning is fully retracted, press and hold the retract switch for 3 seconds.
 - The awning is now in pairing mode for 5 minutes.
5. The BT12 control module will automatically pair to the device then go to working mode.

NOTES:

- The module will pair to the physically closest unpaired device first. Repeat the pairing steps for each additional device (the module remembers the devices that have been paired).
- Refer to the Carefree Connects Mobile App manual for setting up and pairing a smart device (such as a smart phone or tablet).
- Multiple devices can be paired to the awning up to a maximum of 8 peripheral devices.
 - Only one active BT Motion Sensor can be paired to the BT12 Control Module.
 - Only one active BT Remote can be paired to the BT12 Control Module.
 - Multiple mobile devices (smartphone or tablet) can be paired to the BT12 Module but only 1 can be active at a time.

PAIR YOUR MOBILE DEVICE TO YOUR AWNING

NOTE: If you have multiple devices to pair to your awning but wish to pair your mobile device first, ensure your mobile device is positioned closest to the awning prior to completing the following steps:

1. Upon launching the app, you will land on the home screen. Tap on the grid icon on the top left of your screen to enter the Awning Management screen.
2. Locate the awning you wish to claim in the Available Awnings section, and tap on its icon.
3. Tap the Add to My Awnings button in the pop-up window. The selected awning will move into the My Awnings section of the screen.
4. Your paired awning should now be located at the top of your home screen. Tap on the icon from either the My Awnings area of the Awning Management page or from the top of your home page to connect to it.

AWNING OPERATION VIA CONNECTS MOBILE APP

NOTE: When the passcode lockout is enabled, a screen will popup requesting your 4 digit pin before allowing you to use the app.

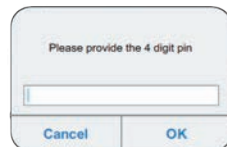

If you enabled the passcode but did not specify a personal pin, the default pin number is "1 2 3 4".

EXTENDING YOUR AWNING

Once your device(s) have been paired to your awning, you can begin to operate your awning. The awning can be extended using the physical switch, the mobile app, or the BT Remote.

RETRACTING YOUR AWNING

If you wish to retract your awning, you can do so using the physical switch, mobile app, or the BT Remote. Again, the physical switch must be in the ON position before the awning can operate.



CONTROLLING YOUR AWNING LED LIGHTS

Turn the awning lighting switch "ON". NOTE: The physical switch must be in the ON position. If the lighting switch is off, a popup will appear on the home screen when you try to turn the lights on.

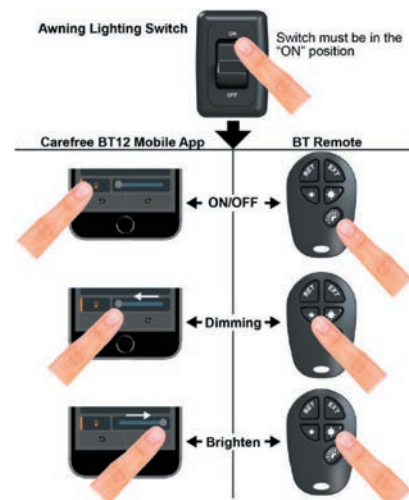

- Turn the lights on or off by tapping the light bulb icon on the app or on the BT Remote, press the bottom button with the sun symbol.
- The awning LED lights must be powered ON for the LED dimmer to function. Using the mobile app, you can slide the LED slider to the left to dim the LED lights, or to the right to brighten them.
- To dim the LED lights using the BT Remote, press the left button with the small star icon. To brighten the lights, press the right button with the large star icon.

ADJUST THE POSITION OF YOUR LED LIGHTS

Upon extending your awning, the LED lights will automatically position themselves at approximately a 45° angle toward your coach. If you wish to point them in a different direction or at a different angle, you can use the mobile app to reposition the roller tube.

1. Open your mobile app and extend your awning.



2. Once the awning is fully extended and has settled into the default rollback position, press the rollback adjustment buttons at the bottom of the Home screen until you reach the desired position. Tapping the left button will slightly retract the awning, while tapping the right button will slightly extend it.
3. Once you have found the position you like, retract the awning to save the position. Now, every future extension should roll out to your saved position.

NAVIGATION BUTTONS

The Awning Management button icon on the home screen resembles a square grid and will take you to the Awning Management page when pressed. This is where you can claim the awnings you wish to control via the app. See the next section of this manual for additional information.

Pressing the Carefree icon will take you to the Carefree website when you wish to add to your awning collection or to contact Carefree.

Pressing the gear icon will provide access to the following pages:

- Settings Page: If your awning is equipped with the BT Motion sensor, you can adjust the motion sensitivity level of the awning.
- Peripherals Page: This page displays the status of the peripheral devices. The Notifications area offers status information about your awning.
- About Page: This page displays your awning's firmware version, identification numbers, and ignition lockout status (if applicable).

Source(s): Carefree Connects Mobile App User's Guide

Product(s): Carefree of Colorado 12V Wireless Control System (Model: SR0120, Newmar Part Number: 148744)

Dometic Power Awning Pro Patio Awning Operation (Model: 9100 Series)

This article provides basic operation instructions for a Dometic Power Awning Pro Patio Awning (Model: 9100 Series).

NOTE FROM NEWMAR

Awnings may be disabled if the coach park brake is not set and/or the ignition key is turned on.

Extending The Awning

⚠ CAUTION

Maintain a horizontal distance of at least 16" between fully open awning and any permanent object.

1. Press and hold the (extend) awning switch until awning extends to its out position.
2. Verify valance is in correct position, and adjust if necessary. If the awning is over-extended, press the awning switch down to retract the awning until the valance is in the correct position.



⚠ NOTICE

Awning will stop when button is released no matter how far awning is extended / retracted.

⚠ WARNING

IMPACT OR CRUSH HAZARD: Do NOT allow awning to remain in over-extended position as this could trap heavy debris, or could cause water to pool or snow to accumulate on awning fabric. This weight will cause awning to become unstable, and bend or collapse. Failure to obey this warning could result in death or serious injury.



Adjusting Awning Pitch

The FRTA (fabric roller tube assembly) will be lower than RV's awning rail when hardware is fully extended. This pitch (slope) will help accommodate water runoff. If a steeper pitch is desired, the FRTA must be lowered.

To lower FRTA:

1. With awning fully extended, loosen adjustable knob on adjustable pitch arm assembly (bottom arm).
2. Press in on spring loaded button on right side of adjustable pitch arm assembly to allow adjustment.

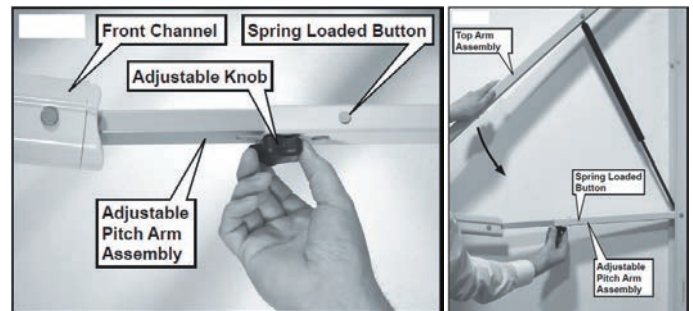

⚠ CAUTION

PINCH HAZARD: Keep CLEAR of openings around adjustable pitch arm assembly while adjusting awning pitch (slope). Adjustable pitch arm assembly (bottom arm) will telescope. Failure to obey this caution could result in injury.

⚠ NOTICE

Do NOT allow corner of entry door to contact awning fabric. Otherwise, premature wear or tearing of awning fabric could occur.

3. Pull top arm assembly down to lower FRTA to desired height.

4. While holding top arm assembly in place, tighten adjustable knob to set pitch (slope).

WARNING

IMPACT OR CRUSH HAZARD. ALWAYS lower one side of hardware into water shed position when adjusting awning [pitch / slope]. Otherwise, water could pool on awning fabric. Failure to obey this warning could result in death or serious injury.

5. Repeat steps (1) through (4) for opposite side.

IMPORTANT

Make sure the top arm assembly that's farthest from entry door is lowered more than the other.

Preparing The Awning To Shed Water

WARNING

IMPACT OR CRUSH HAZARD: Do NOT allow water to pool or snow to accumulate on awning fabric. The awning will become unstable, and could bend or collapse. Whenever heavy rain or snow is expected, place awning in stowed (closed) position. Failure to obey this warning could result in death or serious injury.

Lowering one arm assembly into water shed position (to create a slope from other arm assembly) will allow water run-off during light rain.

1. With awning fully extended, verify top arm assembly nearest entry door is fully extended, and that adjustable knob is tightened.

WARNING

IMPACT OR CRUSH HAZARD. NEVER disengage adjustable knob during windy conditions, or with water pooled or snow accumulated on awning fabric. This could cause the awning to move unpredictably, become unstable, and bend or collapse. Failure to obey this warning could result in death or serious injury.

NOTICE

Do **NOT** allow corner of entry door to contact awning fabric. Otherwise, premature wear or tearing of awning fabric could occur.

2. Loosen adjustable knob on adjustable pitch arm assembly (bottom arm) that's farthest from entry door.

IMPORTANT

Lowering the arm assembly that's nearest entry door could allow door to contact fabric. If awning pitch was previously adjusted lower, raising arm nearest entry door will provide more fabric clearance.

3. Press in on spring loaded button on right side of adjustable pitch arm assembly to allow adjustment.

CAUTION

PINCH HAZARD: Keep CLEAR of openings around adjustable pitch arm assembly while adjusting awning pitch (slope). Adjustable pitch arm assembly (bottom arm) will telescope. Failure to obey this caution could result in injury

4. Pull top arm assembly (farthest from entry door) down until awning slopes approximately 10°, or 9" minimum from other arm assembly.

IMPORTANT

This slope requirement is in addition to the slope from RV's awning rail.

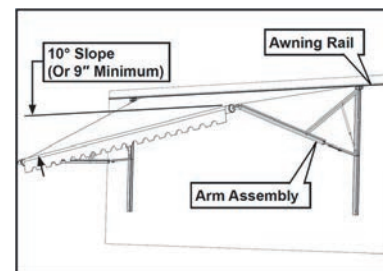

5. While holding top arm assembly in place, tighten adjustable knob to set in place.

Retracting Awning Prior To Travel

1. Remove any accessories from the awning, and make sure the awning path is clear of obstructions.
2. Ensure the LED light strip switches are in the OFF position.
3. Press and hold awning switch in the retract position until the awning is fully closed.

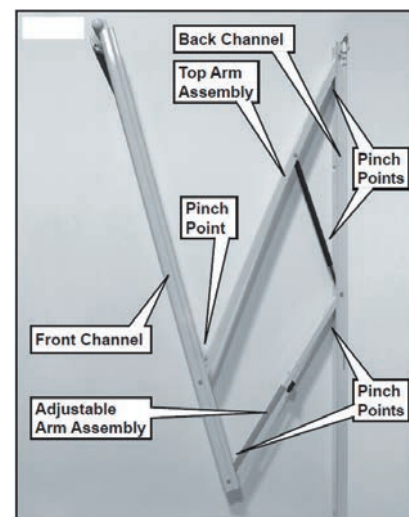

⚠ WARNING

Keep **CLEAR** of arm assemblies while closing awning. Arm assemblies will [fold / close] against back channel. Failure to obey this warning could result in death or serious injury.

⚠ WARNING

IMPACT OR CRUSH HAZARD: Make sure ignition interlock is working correctly before traveling with RV. If awning responds to switch with ignition in **ON** position, accidental operation during transit could occur. The awning **MUST** be disabled, then serviced by a qualified service technician. Failure to obey this warning could result in death or serious injury.

Operating The Awning Via Handheld Remote Control

Button	Function
Up	Press and hold the up arrow to retract the awning.
Stop	Press the button with a square icon to stop the awning in the current position.
Down	Press and hold the down arrow to extend the awning.
LED Lights	Press in the center between the double left and double right arrows to turn the awning lights on and off.
<< LED Lights	Press the double left arrow to dim the LED light strip.
>> LED Lights	Press the double right arrow to brighten the LED light strip.



Compartments

Storage compartments are located on the exterior sides of your unit. These compartments provide additional space for your belongings while you are traveling. Select coach models feature optional manual slide trays and standard lighting, while others may feature compartments complete with power slide trays, dual side access, and automatic LED lighting throughout the storage area.

⚠ IMPORTANT

Before traveling, perform a pre-trip inspection that includes checking each baggage door to ensure each one is latched and locked securely.

⚠ IMPORTANT

If the coach is equipped with a separate awning light switch, the awning lights must be turned on via the Dometic remote control (press between the double left and double right arrows) before the light switch can be used to operate the awning lights.

Operating The Led Lights In The Awning Tube

1. Turn the awning light switch to the ON position to illuminate LED light strip in the awning tube.
2. Do NOT use the tube LED light strip while the awning is closed. Turn the awning light switch to the OFF position when the LED light strip is not in use.

Operating The Awning Manually

For information regarding manual operation of the awning during a power failure, refer to Dometic’s 9100 Awning Operating Instructions in Newgle.

Source(s): Dometic 9100 Awning Operating Instructions
Product(s): This source is associated with more than one product. Refer to Newgle for more information about the product(s) offered for your coach’s model year.



⚠ CAUTION

Use caution when packing the storage areas. Do not pack items around water heaters, refrigerators, furnaces, hydronic heating units, or any other heat-producing appliances.



Doors, Handles, and Chimes

This article provides basic information about the doors, handles, and chimes installed in a Newmar coach. The front entrance door is equipped with a dead bolt lock for added security, and select coach models may have a power flush step well cover.

For your safety and convenience, all current models feature a grab handle at the entrance door to assist you in entering and exiting the coach. Select models may incorporate the keyless entry system, and many have a doorbell button integrated into the grab handle as well.

When the door is opened fully, the door has a “door check” feature that will automatically hold the door open. To close the door, simply pull to release the detent, then close and latch the door. Center entry doors may incorporate a gas strut to hold the door open.

Entry and Screen Door Overview

This article provides an operational overview of the entry and screen door.

⚠ NOTICE

This information is generic in nature and may not be specific to your exact coach model and/or year.

⚠ NOTICE

Do not extend the deadbolt before closing the door, as damage may occur.

Deadbolt Operation

1. From the inside of the coach, operate the dead bolt by first making sure the door is closed securely in the second stage latch. Rotate the dead bolt lever clockwise.
2. From the outside of the coach, use the key and rotate it counter-clockwise to engage the dead bolt.



3. To lock the door without using the deadbolt, press and hold the number one key on the keyless entry touch pad (if equipped).
4. Flip the red lever before shutting the door, and use the key fob (if equipped).

Entry Screen Door Operation

1. Store the entry screen door's top screen for travel by pulling down in the center and unlatching the two hooks at the bottom.
2. Allow the screen to retract gently while continuing to hold the bottom of screen.
3. When not traveling, pull the screen down in the center, and latch the screen using the hooks at the bottom.

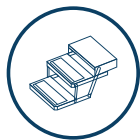

Entrance Steps

Your coach may be equipped with electric entrance door steps. Select coach models may be equipped with hydraulic steps. Both types of steps automatically extend when the entrance door is opened and retract when the entrance door is closed.

Electric Exterior Entrance Steps Overview

This article provides an operational overview of the electric exterior entrance steps installed on select coach models.

Operation

With the **Entrance Step switch** in the overhead cabinet flipped in the operational position, the entrance step will operate each time the entrance door is opened or closed.

If the door is closed when the **Entrance Step switch** is flipped opposite of the operational position, the step will extend one time. If the door is open when the Entrance Step switch is flipped opposite of the operational position, the step will stay extended.

The step will remain in the extended position unless the ignition signal is activated, which overrides the **Entrance Step switch**. In this case, the step will extend or retract when the door is opened or closed.



Kwikee Electric Entrance Step Operation (Model: 22-40 Series)

This article provides basic operation instructions for a Kwikee Electric Entrance Step (Model: 22-40 Series).

⚠️ WARNING

If the vehicle is driven with the step in the extended position, there is the possibility of causing major damage to both the step and the coach. Always be sure that the step is fully retracted before traveling. If the step is left extended and strikes an obstruction while the vehicle is moving, major damage to both the step and the vehicle could result.

⚠️ CAUTION

Step safely supports up to 300 lbs. DO NOT OVERLOAD THE STEP ASSEMBLY.

1. Close the door. The step should retract and lock in the UP position.
2. Open the door. The step should extend and lock in the DOWN position with the under step light illuminated.
3. The under step light operation is as follows:
 - The light is on when the step is extended.
 - The light is off when the step is retracted.
 - In the event the coach door/screen door is left open, the light will turn off after five minutes.
 - The under step light is not available on all step models.

Lock/Stationary Extended Mode

1. If your step is equipped with a step switch, and you would like the step to remain in the extended position while the door is opened and closed, place the step switch in the position for the step to extend when the door is opened and retracted when the door is closed (step assembly follows the door). The step should remain in the extended position with the under step light off when the door is closed.
2. With the step switch in the appropriate step lock position, the step extended, and the entrance door closed, turn the vehicle ignition on. The ignition override system will go into effect and the step will automatically retract.
3. Turn the vehicle ignition off and open the door. The step will extend and lock in the DOWN position. This is the "Auto Extend" feature. When the vehicle ignition is turned on, the step will always activate with the door movement, regardless of the step switch position.

Source(s): Kwikee by Lippert Components Electric Step #888 Owner's Manual (2017)

Product(s): This source is associated with more than one product. Refer to Newgle for more information about the product(s) offered for your coach's model year.

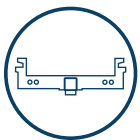

Hitches and Towing Components

Your motorhome is equipped with a hitch and tow plug, as it is designed for towing light loads. Your hitch may provide you with the capability of towing your car or trailer while traveling. A wiring harness or pigtail is needed to connect tail lights, brake lights, turn lights, etc. of the towed vehicle with that of the coach. Some coach models feature rear docking lights to assist with tow vehicle hookup at night.

Prior To Towing

Prior to towing, inspect all towing connections, including the hitch mounting bolts for unusual wear or corrosion. Check the mounting flanges for any deformation, as well as the hitch welds for any cracks, signs of movement, or fatigue in the hitch assembly. Safe and satisfactory performance of the towing system depends on the type of towing equipment connected to the hitch receiver. The assembled length of the drawbar/towing system used should be kept to a minimum. Do not exceed the rated capacities of the hitch or the components used to attach the towed vehicle or trailer.

Towing Capacity

The total weight of the motorhome and any vehicle towed must not exceed the GCWR (Gross Combined Weight Rating). When planning to tow, approaching the GVWR (Gross Vehicle Weight Rating) may reduce the motorhome's towing capacity. When weighing the motorhome, be sure to take passenger locations into consideration. The towed vehicles must have adequate active brakes. Contact your state Department of Transportation or your local Newmar dealer for your state requirements.

⚠️ IMPORTANT

Newmar is not responsible for damage or failure of the hitch receiver caused by the use of excessively long drawbars or other styles of drawbars that create leverage loads on the hitch receiver beyond its designed capabilities.



Ladders

This article provides safety information for using a ladder installed on a Newmar coach.

⚠ IMPORTANT

When going up or down the ladder, make sure the ladder is clear of debris, ice, water and any other slippery substance. Wear shoes that provide good traction. Slip-on shoes are not recommended when using the ladder.

⚠ IMPORTANT

The rear ladder maximum weight capacity may differ by manufacturer and dimensions of the ladder. Observe and do not exceed the weight rating for your ladder, which may be noted on the bottom of one of the ladder rungs.

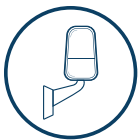

Mirrors

Your coach may be equipped with convex remote-controlled two-part exterior rear view mirrors. The top portion of the mirror is flat, providing conventional reflected views down the sides of the RV, while the bottom portion is convex to provide an expanded view, helping to eliminate blind spots. These mirrors may also contain heating elements to defog, defrost, or de-ice the mirror glass during cold weather operation. Some mirrors can be operated via remote control.

Exterior Mirror Multi-Directional Adjustment and Heat Toggle Switch Operation

This article provides basic operation and adjustment instructions for an exterior mirror.

Overview

Your coach may be equipped with convex remote-controlled two-part exterior rear view mirrors. The top portion of the mirror is flat, providing conventional reflected views down the sides of the RV, while the bottom portion is convex to provide an expanded view, helping to eliminate blind spots. These mirrors may also contain heating elements to defog, defrost, or de-ice the mirror glass during cold weather operation.



Operation

Some mirrors can be operated via remote control. These mirrors are adjusted by using the multi-directional switches located on the driver's door (optional on some models) or console. Make sure the seat is positioned for proper vehicle control, and then adjust the mirrors for maximum rear visibility prior to driving.

⚠ IMPORTANT

Objects viewed in the convex mirrors are closer than they appear.

ADJUSTMENT CONTROL

The Mirror Control switch operates the electric portion of the mirror and adjusts the mirror up, down, back, and forth. To select which mirror to adjust, flip the selector to the left or right position. Move the selector to the center position to obtain the best view and make the directional arrows inactive. The adjustment control moves the top half of both mirrors. The bottom half of the mirror is convex and is adjusted manually.

HEAT

The red switch located near the mirror adjustment control operates the mirror heat (if equipped). The ignition switch must be on for the mirror heat switch to operate.

1. To turn the mirror heat on, turn the switch to the "ON" position. The light will illuminate on the switch when the mirror heat is operating.
2. To turn the mirror heat off, turn the switch to the "OFF" position. The light on the switch will turn off when the mirror heat is no longer operating.

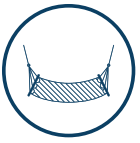

Optional Accessories

Flagpole Assembly Overview

This provides information about the flagpole option available on some coach models (Option # R045).

Assembly Components

The flagpole assembly (Newmar part # 143894 or 138708) should handle any standard 1-inch flagpole that may mount on the side of a house. If the coach is equipped with the optional flagpole mount (Newmar option # R045, Newmar part # 138682 and 138683), it is typically located on the front of the coach just in front of the entrance door. The flag assembly may be shipped from the factory in a kitchen drawer.

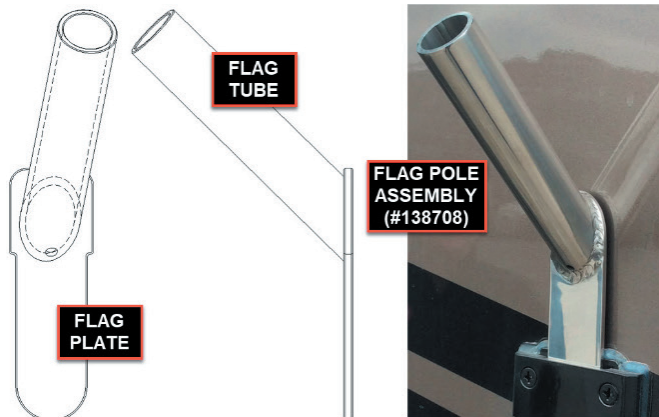

Assembly Installation and Removal

The mount's slot allows the angled flag assembly to easily be installed while displaying a flag and easily removed for travel. To display a flag, simply slide the assembly down into the mounting bracket, then install the flagpole (not provided by Newmar). To remove the flag and assembly, reverse the order of installation. For coach owners who wish to have a flagpole assembly installed on their coach, contact the Newmar Parts Department to order the proper assembly components. Newmar recommends having the mount installed by an Authorized Service Center.

Flagpole Safety

⚠ CAUTION

The flagpole assembly is not intended to be used in high wind conditions.

⚠ WARNING

When installing a flagpole assembly, ensure you have proper clearance away from overhead electrical lines or other obstructions.

⚠ DANGER

Do not leave flagpole assembly in mounting bracket while vehicle is in motion.



Paint, Roof, and Siding

This article provides a basic overview and maintenance of the roof and sidewalls.

Roof and Sidewalls Overview and Maintenance

Sidewalls

Newmar RV sidewalls are designed with structure to make them more rigid and dependable. By building aluminum frames with studs 16 inches on center, your sidewalls and roof will form a strong, lightweight, integrated structure so you can enjoy superior insulation. The sidewalls and end caps of your coach are constructed of smooth fiberglass, which features an automotive style “Clear-Coat / Color Coat” painted finish.

SIDEWALLS MAINTENANCE

This article provides a basic overview and maintenance of the roof and sidewalls. Clean any unpainted fiberglass material with a mild cleanser and warm water. Use only soft cloths. Using stiff bristle brushes may cause scratches in the fiberglass surface.

IMPORTANT

Newmar is not responsible for weathering/oxidation of gel-coated surfaces.

EXTERIOR PAINT MAINTENANCE

For cleaning and waxing instructions and recommended products, refer to the Miscellaneous Care and Maintenance section in Newgle. Paint codes are typically posted on the back side of one of the upper kitchen cabinet doors.

Roof

This unit is manufactured with a 7mm decking material covered with fiberglass or rubber membrane. Proper care and routine maintenance of your roof is necessary for trouble-free performance. Frequent inspection (at least annually) of roof drains, seams, and joints should be performed by an Newmar Authorized Service Center.

Rubber Roof Care and Maintenance

This article provides basic care and maintenance information for a rubber roof. Proper care and routine maintenance of your roof is necessary for trouble-free performance. A ladder may be installed on your coach to assist you in gaining access to the roof for the sole purpose of routine inspections and maintenance.

Proper care and maintenance of your recreational vehicle, including your rubber roof, is important for trouble-free performance. Normal maintenance is simple and easy, and does not require special materials. Keep the roof clean. Clean the roof at least four (4) times annually.

1. For normal cleaning, use RC100 Decor Synthetic Roof & General Purpose cleaner or a mild laundry detergent.
2. Rinse the complete roof with clean water to remove any loose dirt or debris.

NOTE FROM NEWMAR

For information about cleaning your roof drains and gutters, refer to the Roof Drains article in Newgle.

ROOF MAINTENANCE

Regular cleaning and maintenance is essential to insuring a long, trouble-free life. Before cleaning, it is important that you inspect the sealants and gaskets used to seal components to the roof structure to be certain there is no leakage during the cleaning process. Any cracks or voids in the sealants and seals **MUST** be repaired prior to spraying the roof with water. Extreme caution should be used when inspecting or cleaning the roof.

WARNING

It is recommended that access, cleaning, and maintenance be conducted by a qualified professional at your local dealership. Use caution if working on top of your vehicle. The wet roof surface is extremely slippery.

If inspection and/or maintenance becomes necessary, stay on the main roof area. Do not walk or stand on the raised portions of the roof or the gutter rail area (if applicable). Do not exceed 300 pounds on the roof.

NOTICE

Do not place items on the roof for transportation. The roof was not designed to support the transportation of luggage or other items.

CAUTION

Do not use general purpose cleaners or conditioners containing petroleum solvents, harsh abrasives or citric-based cleaners. You may cause irreparable damage to your roof.

3. Using a medium bristle brush, along with your selected cleaner mixed with water, scrub the entire roof. Rinse thoroughly with clean water to avoid residue build up on the roof or sidewalls of the vehicle.
4. For more difficult stains, you may use cleaning materials mentioned above in a more concentrated mixture. For stubborn stains, use of a cloth dampened with household bleach. Household bleach can be used (fully concentrated) and allowed to soak in stubborn stain areas, then scrubbed with a medium bristle brush or rag. Rinse thoroughly. Do not pour the bleach on the roof and allow it to run down the sides of the vehicle. Concentrated bleach may damage the graphics.

⚠ WARNING

Use caution when working on top of your vehicle. The wet roof membrane may be extremely slippery.

*Source(s): Rudy's Expert RV Roof Care Handbook (Dicor)
Product(s): Dicor BriteTek Roof (Newmar Part Number: 41787 , 29404A , 25131 , 25110)*

Exterior Paint Overview

We're passionate about paint. And we believe that the RV we create for you should be as beautiful as it is comfortable. Our coaches are more gorgeous than ever, with a sleek, stunning exterior showcased by all-new graphics and the exquisite Full-

Paint Masterpiece™ Finish. Our goal is to create a perfect finish every time we paint a Newmar. This is how we do it:

- Between 12 and 16 gallons of paint are used on each model.
- Several types of primer are applied, followed by a base coat, color for graphics and a final, clear coat.
- We use materials of only the highest quality and integrity.
- Our technicians are among the most knowledgeable and highly experienced.
- The equipment and techniques we have created are among the most advanced.

We always ensure that each coat of paint lays flat and smooth to produce a stunning brilliance. That's how we can promise that your Newmar RV will offer you an exterior of the highest quality and durability.

For cleaning and waxing instructions and recommended products, refer to the Miscellaneous Care and Maintenance section in Newgle. Paint codes are typically posted on the back side of one of the upper kitchen cabinet doors. For more details about paint codes, refer to the "Coach - Paint Code Pages" section in NewPar, Newmar's online parts catalog (Parts and Warranty Reference > Coach - Paint Code Pages > Coach Year > Coach Model > More Info).

Diamond Shield Paint Protection Use and Care Guidelines

This article provides basic care and maintenance guidelines for the Diamond Shield paint protection. Follow the use and care guidelines as outlined by Diamond Shield.

⚠ IMPORTANT

Once applied, refrain from washing for 48 hours, washing after that time presents no problems. Do NOT use harsh or abrasive cleaners or detergents.

Step 1: Wipe Regularly

Wiping bugs and road grime off your vehicle, with a wet soft cloth, as soon as you get a chance is essential to keeping your film looking great. This will also reduce the risk of staining and discoloration from bug acids, runoff stains, and road grime left on for an extended period. When done, apply 303 Aerospace Protectant!

Step 2: Wash Monthly

Washing monthly will give your film the deep clean it deserves and will ensure the film remains crystal clear. We recommend using Advanced RV & Auto Wash and a soft cotton or lambswool mitt to apply. Do not use any abrasive brushes, rags, cloths, or compounds. When you're done, apply 303 Aerospace Protectant!

⚠ IMPORTANT

Do not use Rain-Ex products or bug and tar removers.

Step 3: Wax Quarterly

Waxing your film on a quarterly basis, or more, will add that extra layer of protection to your film. Keeping it waxed will prevent damage from bug acids and road grime, and allow the film to effortlessly be wiped clean. We recommend using Advanced RV & Auto Wax, a synthetic polymer cream wax designed specifically for Diamond Shield.

General Care Precautions

Several cleaning techniques and cleaning products should NEVER be used on the areas protected by Diamond Shield on your vehicle.

- Do not pressure wash.
- Do not use Rain-X products.
- Do not use any abrasive brushes, rags, cloths or compounds.

This general care list is not comprehensive. Please call Diamond Shield at 1-888-806-5862 before using any products not specifically listed on Diamond Shield's website. Using unapproved sprays, cloths, or waxes may cause damage to the film, which may not be covered under warranty.



Wheelchair Lifts

Braun Century Series Wheelchair Lift Operation (Model: NDCC)

This article provides an overview and operation instructions for a Braun Century Series Wheelchair Lift (Model: NDCC).

WARNING

Read and become familiar with all lift operation safety precautions, operation notes and details, operating instructions and manual operating instructions prior to operating the lift.

1. Read the manual before operating the lift.
2. Load and unload on a level surface only.
3. Engage the vehicle parking brake before operating the lift.
4. Provide adequate clearance outside of the vehicle to accommodate the lift.
5. Do not operate the lift if you suspect lift damage, wear, or any abnormal condition.
6. Keep the operator and bystanders clear of the area in which lift operates.

Whenever a wheelchair passenger is on the platform, the:

- Passenger must be positioned fully inside yellow boundaries.
- Wheelchair brakes must be locked.
- Inner roll stop and outer barrier must be up.

CAUTION

This lift is not intended to be independently operated by an individual occupying a wheelchair or similar conveyance. This lift should only be operated by a capable, qualified attendant who is positioned on the exterior of the vehicle and is clear of the travel path of the lift platform. Do not operate the lift from the inside of the vehicle.

WARNING

Failure to follow these rules may result in serious bodily injury and/or property damage.

CAUTION

Diesel coaches equipped with the R500 wheelchair lift: The lift is intended to be used with the suspension air bags dumped to ensure adequate ground contact of the lift platform.



Lift Operating Instructions



NOTE FROM NEWMAR

Operation Pre-Requisites for Wheelchair Lifts Mounted on Class A Coaches:

- 12 volt batteries must be charged
- Ignition switch must be off
- Transmission must be in Park
- Lift door must be open

NOTE FROM NEWMAR

Operation Pre-Requisites for Wheelchair Lifts Mounted on Diesel Coaches:

- 12 volt batteries must be charged
- Ignition switch can be off or on
- Park brake must be set
- Lift door must be open

1. Open door(s) and secure.

TO UNFOLD PLATFORM

1. Stand clear and press UNFOLD switch until platform stops (reaches floor level). Note: In event platform does not unfold, press FOLD switch to release Lift-Tite latches.

TO LOAD PASSENGER

1. Load passenger onto platform and lock wheelchair brakes.
2. Press UP switch to fold outer barrier up and raise platform to floor level.
3. Unlock wheelchair brakes and unload passenger from platform.

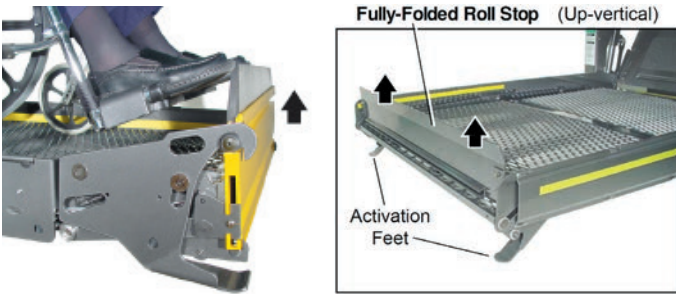

TO UNLOAD PASSENGER

1. Load passenger onto platform and lock wheelchair brakes.
2. Press DOWN switch until entire platform reaches ground level and outer barrier unfolds fully.
3. Unlock wheelchair brakes and unload passenger from platform.

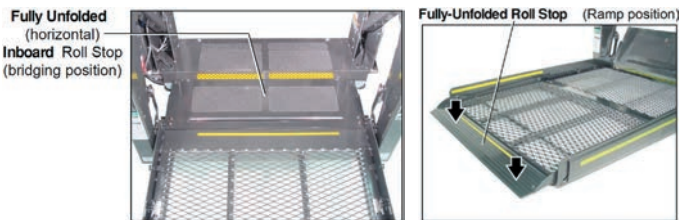

TO FOLD PLATFORM

1. Press FOLD switch until platform stops. Release switch.
2. Close door(s).



Manual Operation

TO UNFOLD PLATFORM

1. Close hand pump valve (turn clockwise).
2. Insert handle in pump and stroke until platform folds fully (stops).
3. Open hand pump valve (turn counterclockwise) until platform reaches floor level. Open 1/2 turn only.
4. Close hand pump valve (turn clockwise).

DOWN (TO LOWER)

1. Open hand pump valve (turn counterclockwise). Open 1/2 turn only.

UP (TO RAISE)

1. Close hand pump valve (turn clockwise).
2. Insert handle in pump and stroke until platform reaches floor level.

TO FOLD PLATFORM

1. Insert handle in pump and stroke. Note: Close valve before operating electric pump.



Weight Restrictions

These labels are examples of the listed capacity for your wheelchair lift. Do not exceed the weight limit posted in your coach for any reason.

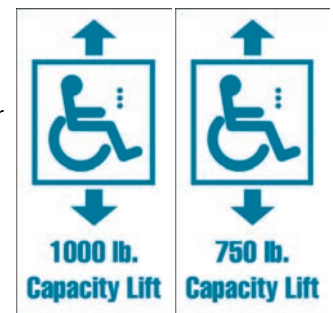

Source(s): Braun Corporation Quick Reference Lift Operating Instructions

Product(s): Braun 54" Stroke Wheelchair Lift (Model: NDCC54S34X54, Newmar Part Number: 143072)

Wheelchair Lift Access Door Key Fob Operation

This article provides basic operation and programming instructions for a Challenger Door wheelchair lift access door POP Locks key fob.

Operation

1. Press the top button to lock the wheelchair lift access door.
2. Press the bottom button to unlock the wheelchair lift access door.

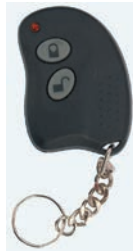

Key Fob Battery Replacement

To replace the T-25 Key Fob battery (Fig D.), the shell of the transmitter must be removed. Pry between the depression around the shell and separate the fob into 2 pieces exposing the battery as shown in Fig. D. Replacement batteries are 12v part # GP23A, CN23A, EL12 and VR22 or similar class battery.

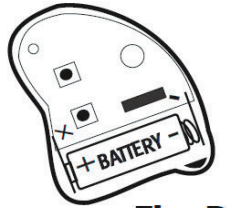

Fig. D
Front With Cover Off

Replacement battery must be installed as shown in Fig. D. Its orientation is specific to - + polarities clearly marked. Replace cover and test.

Key Fob Programming

If the key fob's light turns on but does not lock or unlock the access door, the key fob may need to be programmed.

1. Disconnect or turn off power to the module. It is suggested that this be done at the air compressor, normally located in the storage compartment (may be behind an access cover).

2. Power it back on, and within 5 seconds, press button 1 (top) and button 2 (bottom) at the same time. The system will then enter the code learning mode. The UNLOCK OUTPUT will trigger to remind you that the system is in code learning mode.
3. Within 5 seconds after entering the code learning mode, press any button on the transmitter. The UNLOCK OUTPUT will trigger to tell you the transmitter has been recognized and is compatible with the system. A maximum of 12 transmitters can be coded per system.
4. During code learning, if there is no action after 5 seconds, the system will exit the code learning mode. The UNLOCK OUTPUT will be the reminder.

IMPORTANT

To prevent the door from opening during this process, open the air valve (blue) in the storage area while programming the key fob.

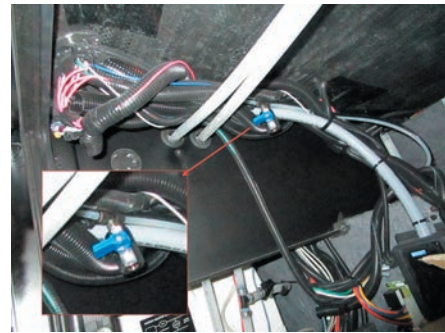

Source(s): Challenger Door POP Locks Keyless Entry Timed Relay and Key Fob Code Learning and Configuration Instructions

Product(s): Challenger Wheelchair Lift Access Door Keyless Entry FOB (Model: 699030, Newmar Part Number: 125776D)

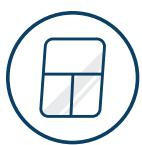

Windows and Windshields

The windows installed in your coach are either single or double pane tinted safety glass. Most current models offer sliding glass windows. A power window may be installed on the driver's side on select models. Proper care and maintenance of your windows and windshield is critical to maintaining good visibility and safe operation of the coach.

How To Open and Close The Emergency Exit Windows

This article provides step-by-step instructions for opening and closing emergency exit windows and doors.

Hehr Egress Emergency Exit Window

Select Hehr windows have an opening window pane in the egress window for ventilation. This style of window can also be opened in the event of an emergency.

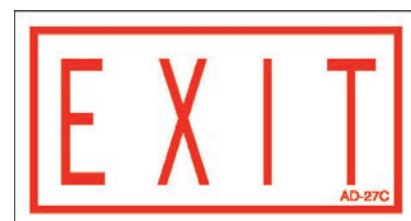



TO OPEN THE VENT:

1. Unclip and lower the arm.
2. Swing the arm 90 degrees, and push out on the arm until the red handle latches.

TO CLOSE THE VENT:

1. Unclip the red handle from the latch by lifting slightly while pushing outward.
2. Once the latch releases, pull the arm in until the window is closed.
3. Rotate the arm 90 degrees until it latches into the closed position.

IN THE EVENT OF AN EMERGENCY, OPEN THE WINDOW:

1. Remove the screen by pulling out on the red handle.
2. Push and release the lever from the locking hook.
3. Rotate the lever 90 degrees, and push it through the slot in the window frame.
4. Escape through the opening.

Hehr Double-Latched Emergency Exit Window



TO OPEN THE EMERGENCY EXIT DOUBLE LATCH STYLE WINDOW:

1. Unclip and lower the arm.
2. Swing the arm 90 degrees, and push out on the arm until the red handle latches.

TO CLOSE AND LATCH THE EMERGENCY EXIT DOUBLE LATCH STYLE WINDOW:

1. Pull the window shut while holding the window track with one hand.
2. With the other hand, rotate the latch up until it connects with the track on the window.
3. Press the front side down until it latches.
4. Repeat the steps for the second latch.

How to Operate a Vented Crank-Style Window

This article provides an operational overview of a vented crank-style window.

Opening and Closing The Vent

To open a vented crank-style window, rotate the window knob clockwise until the window reaches the fully-extended position. The operator arms near the bottom will be nearly straight when the window is fully extended.

To close a vented crank-style window, rotate the window knob counterclockwise until the window is closed and the knob can no longer be turned. The operator arms near the bottom should also be snug.



Removing The Screen

To clean the inside of the window and the screen, the screen must be removed.

1. Remove the crank knob using a Philips screwdriver in a counterclockwise motion.
2. Carefully pull on the screen frame until the clips pop out from the window opening.
3. Clean the screen and inside of the window.
4. Carefully pop the screen back into the window frame.
5. Reinstall the crank knob using a Philips screwdriver. Hold the crank knob while tightening the screw in a clockwise motion.



How To Clean The Windows

This article provides information about windows used by Newmar, which are equipped with sliding screens that can be removed for cleaning.

Removing The Screen

Open the window and screen. Press upward on the screen frame top, pushing the frame deeper into its pocket. This will compress the springs and allow the screen frame bottom to rotate out of the bottom track. Be careful with the plastic screen springs, so that they can be re-used.

Cleaning The Glass

Apply straight mineral spirits to a clean, soft cloth and wipe the glass. Dry with a clean cloth. Next, clean the glass again, using a clean cloth with a 50-50 mix of water and a household window cleaner like Windex™ or GlassPlus™. If there is still a residue, remove it with rubbing alcohol and dry.

Source: Hehr Service Manual

How To Prevent Window Condensation

This article provides a preventative overview of condensation on the inside of the windows and within the coach. Accumulation of condensation on surfaces within your unit occurs when warm, moist air contacts a cool surface. It is most evident on the inside of windows.

IMPORTANT

Since surface condensation within the coach cannot be controlled by the manufacturer, damage caused by condensation is not covered by your Newmar Limited Warranty.

Damage may occur to your unit if excessive condensation exists. This problem can be controlled by:

1. Slightly opening a window or roof vent to allow the moisture to escape from the unit.
2. A small dehumidifier is also very effective in removing moisture from the air.

Condensation levels are highest during times when a person is cooking or taking a shower in the unit, but these are not the only times condensation is present. Condensation can migrate through ceiling panels and saturate the fiberglass insulation in your ceiling cavity. This condition often causes the occupants to believe the recreational vehicle has a roof leak. Walls and ceiling panels may also become wet when the moisture accumulates on these surfaces.

IMPORTANT

Newmar Corporation does not recommend the use of any catalytic heaters.

Windshield Maintenance and Replacement

Proper care and maintenance of your windshield is critical to maintain good visibility and safe operation of the coach.

Care and Maintenance

Keeping your windshield clean will provide optimum visibility to view the road ahead. Should you encounter rock chips or cracks, have them fixed by an automotive glass professional immediately to avoid costly windshield replacement. If the crack spreads, replacement may be necessary.

Check the windshield washer fluid level prior to each trip, and top off the fluid reservoir as needed.

CAUTION

Do not operate the windshield wipers with damaged blades, as they may cause damage to the glass. Damage to glass by rocks, damaged wipers, or other foreign objects are not warrantable repairs.

Windshield Replacement

When replacing a windshield, Newmar highly recommends purchasing the new windshield through the Newmar Parts department to ensure proper windshield fit. Customers and dealers have experienced many size and installation issues when attempting to use aftermarket windshields. If your windshield needs replaced, make sure that your dealer or glass replacement company purchases the replacement windshield directly from Newmar.

Skylights Overview

This article provides basic information about the skylight installed in the coach.

For improved lighting and headroom, a skylight may also be installed in the bathroom over the shower. The opening provides additional light during daylight hours, and the skylight is tinted to provide privacy and reduce glare.



The skylight should be inspected with the roof and components, and the sealant should be maintained. Some sealants are not compatible with the skylight material. Newmar recommends using Surebond SB-140 butyl sealant around the skylight.

Periodic cleaning using a mild detergent or cleaner specifically designed for plastics (such as Novus No. 1) is necessary; cleaning frequency may depend on the surrounding conditions while driving, parking, or storing the coach.

⚠ WARNING

It is recommended that access, cleaning, and maintenance be conducted by a qualified professional at your local dealership. Use caution if working on top of your vehicle. The wet roof surface is extremely slippery.

Wiper Systems

Wiper System Care and Maintenance

Proper care and maintenance of your wiper blades is critical to maintain good visibility and safe operation of the coach. Clean the rubber element every time you fill your gas tank, and remove loose dirt and road grime from the windshield. When washing your coach, use a small amount of non-abrasive glass cleaner on a wet sponge to clean both the windshield and the rubber wiping elements. In colder climates, use an ice scraper to remove snow and ice. Using your wipers to de-ice your windshield can damage the blades, as well as the arm and wiper motor.

Streaking, chattering, and worn blades may be caused by dry rubber that has hardened and cracked. Streaking can also be caused by oil, tree sap, road tar, or other foreign substances on the blade rubber or windshield. Chattering sounds as the blade passes across the windshield are caused by the “deformity” or “curve” in the rubber that some wiper blades develop over time.

Worn, damaged, or split rubber around the wiping edge is generally caused by age and use, but may be due to the effects of the sun’s ultraviolet rays on the rubber. Damage may also be caused by ice scrapers, automatic car washes, or vandalism. Damage to glass by rocks, damaged wipers, or other foreign objects are not warrantable repairs.

⚠ WARNING

Replace your windshield wiper blades when they become worn or damaged. Worn or damaged wiper blades may cause damage to the windshield, as well as interfere with the driver’s ability, possibly resulting in a crash leading to injury or death.



HVAC

This chapter provides operational instructions for components related to dash and roof air conditioning, fans and ventilation, heating systems, and climate control.

IMPORTANT

Any of the following quick start instructions provided by Newmar should not take the place of the manufacturer's complete documentation. Refer to Newgle for more information about heating, ventilation, and air conditioning components offered for your coach's model year.



Air Conditioning and Heat, Dash

Dash Air Conditioning and Heat Controls and Settings

The article provides a basic overview for the dash air conditioning and heat controls and settings. The dash air conditioning control panel enables the driver to control the temperature, volume, and direction of the air discharged from the heating/air conditioning system. Select coach models may have a driver and passenger control with a switch that allows the driver to override the passenger controls.

Controls and Settings

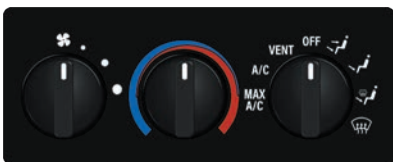

BLOWER SPEED

One of the best ways to control the temperature is by changing the speed of the blower. The blower knob (left of center) provides four speeds in any mode, except when the control is set to OFF.

TEMPERATURE CONTROL

The center knob controls the temperature of the discharged air. Turn the knob to the right (red area) for warmer air, and to the left (blue area) for cooler air.

MODE

To achieve the maximum comfort in your coach, the air must be directed where it is needed. The mode switch (right of center) gives the driver the ability to select where the air will flow. The air conditioning system is designed to operate in all modes except VENT, FLOOR, and OFF. This provides significant moisture, dust and pollen removal for enhanced passenger comfort.

IMPORTANT

If the mode knob is in any position other than OFF, the blower is always on a low speed unless a higher speed is selected.

MAX A/C OR A/C RECYCLE BUTTON

Air is drawn from the passenger compartment and is discharged and recirculated through the dash louvers. This position is used to provide maximum cooling, and is generally used during extremely hot weather conditions for initial cool-down periods. Because this mode does not allow fresh "outside" air into the passenger compartment, it may cause fogging of the windows, and/or stale air, when used for prolonged periods of time. Switch to A/C mode periodically if these conditions occur.

A/C OR SNOWFLAKE BUTTON

Outside/fresh air is drawn into the system and discharged through the dash louvers. These louvers can be adjusted for maximum comfort.

VENT

Outside air is drawn into the system and discharged through the dash louvers. For enhanced passenger comfort, upper-level ventilation air is also discharged through the defrost outlets. When outside ambient temperatures are below approximately 40° F, the A/C compressor may cycle rapidly. Use Vent mode instead of A/C in these temperature conditions to cool the interior air temperature.

⚠ IMPORTANT

For operational safety in the event of the loss of vacuum, the HVAC system is designed to discharge air through the defrost vents to provide continuous windshield defogging.

OFF

The blower motor does not operate in this mode. The fresh air inlet door closes, minimizing outside air infiltration into the vehicle.

BI-LEVEL

Outside air is drawn into the system and discharged through the dash louvers, floor, and defrost outlets. The A/C system operates in Bi-level mode.

FLOOR

Outside air is drawn into the system and discharged through the floor outlets. In some models, a small amount of air is directed to the windshield for defrost. The a/c system does not operate while in floor mode.

MIX

Outside air is drawn into the system and discharged through the floor and defrost outlets. The A/C system operates in Mix mode to provide windshield defogging.

DEFROST

Outside air is drawn into the system and discharged through the defrost outlets. The A/C system operates in Defrost mode to provide windshield defogging.

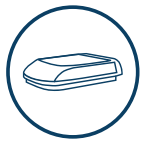

Air Conditioning and Heat, Roof

Roof Air Conditioning and Heat Overview

This article provides a brief overview of the roof air conditioning and heat pump, as well as filter maintenance. Keep your coach comfortable year around!

Your coach’s air conditioners can be operated using the Comfort Control thermostat, KIB V-Bus LCD touchscreen, or the appropriate SilverLeaf screen. For more detailed information about climate control, refer to the appropriate product page(s) and associated content in Newgle.

Some roof top air conditioners have the ability to work as a heat pump when desired to produce heat instead of cooling. These models are effective at producing heat at ambient temperatures (above approximately 40 degrees). If the temperature drops below the threshold, most controls will revert to the furnace or hydronic heating system to produce the necessary heat.

Most air conditioning systems have a two minute built-in time delay, so there may be a slight delay in the operation of the air conditioner after the thermostat is set.

Filter Maintenance

On some coach models, grills with filters may be located behind decorative covers on the ceiling.

1. Remove the vent cover grill from the return air duct or the grill from the air conditioner ceiling assembly.
2. Remove the filter.
3. Wash, rinse, and dry the filter. If the filter does not come clean, or is damaged, replace it with a new filter. Do not substitute other types of filters, as this may restrict air flow and cause other issues. Do not operate the air conditioners without filters.
4. Reinstall the filter on the cover, and place it back into the vent.
5. Repeat the process for each return air vent.

For more information about accessing filters underneath decorative covers, refer to other Newgle articles (How to Access and Clean Air Conditioner Filters with... louvered wood covers, friction, mechanical, or magnetic latch covers).





Fans and Ventilation

Vents operating on 12 volt power may be installed in your coach kitchen and bathroom. Depending on your vent setup, they may be controlled by a switch directly on the vent assembly or the switches located on the wall. Dash fans may also be installed on or in the front overhead cabinet and aid in windshield defrosting and air circulation in the cockpit area of the coach.

Urea-formaldehyde Safety Guidelines

This article provides information about proper ventilation to prevent issues such as condensation and the release of urea-formaldehyde from coach products. Depending on your vent setup, they may be controlled by a switch directly on the vent assembly or the switches located on the wall. Dash fans may also be installed on or in the front overhead cabinet and aid in windshield defrosting and air circulation in the cockpit area of the coach.

Urea-formaldehyde is used in the production of particle board, hardwood plywood, and most paneling. Urea-formaldehyde resin may release formaldehyde vapors into the air, which may cause headaches, and in some people, eye, nose and throat irritation. Formaldehyde may intensify some allergies or upper respiratory problems like asthma.

Providing proper ventilation as needed by operating the power roof vents and opening windows should reduce the risk of such problems.



NOTICE

This vehicle is TSCA TITLE VI COMPLIANT and contains composite wood products that comply with the applicable California Code of Regulations Section 93120.2(a) Phase 2 (P2) formaldehyde emission standards specified on the above date of manufacture.

NI-151

NOTICE

This vehicle is designed as a Recreational Vehicle. When used for an extended period of time, while furnace heating is required, sweating and condensation conditions may occur. The following precautions should be taken to minimize these conditions:

- (1) Use range hood when cooking.
- (2) Use the bathroom power vent when bathing or showering.
- (3) Open windows slightly for ventilation whenever possible.
- (4) Use dehumidifier to keep humidity as low as possible.

NI-13

Dash Overhead Fan Overview (Gas Coaches)

This article provides an operational overview of the dash overhead fans for a gas coach.

The O.H. Fans dash switch turns the overhead fan(s) on low or high, or turns them off, allowing the user to select the desired fan speed. The fan's purpose is to help circulate air around the windshield to prevent the windshield from fogging or icing up.

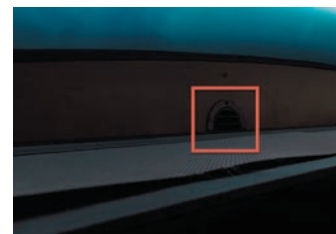

Fan-Tastic Vent Fan Operation via Wall Control

This article provides an operational overview of the Fan-Tastic Vent via Wall Control.

Operation

1. Press the Power button at the top center to start the fan in the previously-used operating mode.
2. Turn off the fan, and close the lid.

MANUAL OPERATION MODE

Press the up or down arrows marked "Speed" to increase or decrease the speed of the fan. There are 13 speeds available, in 15 percent increments from ten percent to one hundred percent. The LED light(s) illuminate next to the selected fan speed percentage.

AUTO OPERATION MODE

Press the up and down arrows marked "Temp" to increase or decrease the temperature setting. There are 13 temperature settings available, in five degree increments from 60 to 90 degrees. The LED light(s) illuminate next to the selected temperature.



Vent Lid Operation

To open the vent lid without running the fan, press the Vent Lid button (up and down button below the speed arrows). Pressing the Vent Lid button will open the lid if it is closed and close the lid if it is open. If the fan is running and the user wants the dome open but the fan turned off, press the Power button at the top center, and then press the Vent Lid button to raise the vent.

Rain Sensor Operation

To disable the rain sensor, press and hold the Vent Lid button for three seconds. The Rain Sensor LED will illuminate when it is disabled. Press and hold the Vent Lid button for three seconds to re-activate the rain sensor and deactivate the LED.



Furnaces

How to Operate and Maintain the Furnace

This article provides basic operation and maintenance instructions for a forced-air furnace. The furnace installed in your coach is a forced-air furnace fueled by propane gas and is controlled by the air conditioner wall thermostat or the KIB touchscreen panel. This thermostat controls both the heating and cooling of the coach. The heat is supplied throughout the coach via the ducts in the floor.

For more information about the thermostat and KIB touchscreen, refer to Newgle.

⚠ WARNING

There are no owner serviceable parts on the furnace. Never attempt to modify this furnace. Fire, explosion, asphyxiation, or carbon monoxide poisoning may occur. If the furnace malfunctions, consult a trained service technician.

⚠ WARNING

Do not store anything directly in front or on either side of furnace.

⚠ AVERTISSEMENT

Ne rien poser contre l'avant ou les côtés du générateur d'air chaud.

Proceed with caution when storing items under the cabinets to prevent crushing or damaging the furnace ducting or blocking the cold air return.

The furnace will not operate properly if the air flow at the floor registers, or the air return to the furnace, is blocked by personal, storage items, or rugs.

Operating The Furnace

To operate, set the thermostat to the desired temperature setting and turn the thermostat ON. Allow 60 seconds for the furnace to begin operating. To shut down the furnace, turn the thermostat OFF. After the furnace has been turned off, the fan will run for approximately 60 seconds to cool down.

⚠ IMPORTANT

Do not leave the fan in active mode while the unit is in storage or unattended for long periods of time. High winds, unusual conditions, or obstructions may prevent the vent from closing, resulting in leakage, which could cause serious damage to the coach interior.

⚠ WARNING

For your safety, do not use gasoline or other flammable liquids near the furnace or any other appliance.

⚠ WARNING

OPEN VENT OR WINDOW ANYTIME VEHICLES, NOXIOUS FUMES OR OTHER HAZARDOUS ITEMS ARE IN THIS AREA.

Smoke and fumes may be created as a result of the residual burn off of the manufacturing compounds that are sometimes present the first time the furnace is used.

This is normal; however, to minimize the smoke and fumes, the initial lighting of the furnace should be completed with the windows and doors open.

WATER COMPARTMENT HEAT VIA FURNACE

Coaches equipped with a forced-air furnace(s) have a designated heat duct for the water compartment in the basement to reduce the risk of freezing.

⚠ IMPORTANT

Heat output to the water compartment is only operational when the furnace is heating the interior of the coach.

Maintaining The Furnace

Check the gas system for leaks at least once a year. On the exterior of the coach you will find a furnace cover. This cover should be removed by authorized service technicians only.

Clean the complete furnace and air tube passageways periodically to remove dust, lint, etc. The furnace should be thoroughly cleaned before the start of each heating season. Any debris in the system may restrict air flow for combustion, bind the combustion air impeller, or prevent the blower motor from running properly.

Also, check the burner pilot orifices for debris. Lint accumulations may cause the blower to become unbalanced, vibrate, and restrict the ability of the blower to move air. If lint is blown into the heat exchanger, it may cause odors or create a fire hazard. Contact an authorized service technician for annual cleaning.

WARNING

Use caution when washing the exterior of your vehicle. Water should not be sprayed directly into the furnace vent. If water is forced beyond the rain baffles into the furnace vent, rusting of the furnace could occur. This could also cause improper combustion.

Suburban Furnace Operation (Model: SF and SFV Series)

This article provides basic operation instructions for a Suburban Furnace (Model: SF and SFV Series).

WARNING

Do not operate furnace while vehicle is in motion or being towed.

WARNING

If you do not follow these instructions exactly, a fire or explosion may result causing property damage, personal injury or loss of life.

This appliance does not have a pilot. It is equipped with an ignition device which automatically lights the burner. Do not light the burner by hand.

Before operating, smell all around the appliance area for gas. Be sure to smell next to the floor because some gas is heavier than air and will settle on the floor.

DANGER

WHAT TO DO IF YOU SMELL GAS

- Extinguish any open flame.
- Evacuate all persons from the vehicle.
- Shut off the gas supply at the gas container or source.
- Do not touch any electric switch or use any phone or radio in the vehicle.
- Do not start the vehicle's engine or electric generator.
- Contact the nearest gas supplier or qualified service technician for repairs.
- If you cannot reach a gas supplier or qualified service technician, contact the nearest fire department.
- Do not turn on the gas supply until the gas leak(s) has been repaired.

Use only your hand to push in or turn the gas control knob. Never use tools. If the knob will not push in or turn by hand, don't try to repair it, call a qualified service technician. Force or attempted repair may result in a fire or explosion.

Do not use this appliance if any part has been under water. Immediately call a qualified service technician to inspect the appliance and to replace any part of the control system and any gas control which has been under water.

Operating Instructions

1. STOP! Read Users Information Manual supplied with furnace.
2. Turn the manual valve (if so equipped) or the valve at the outside LP tank to the "OFF" position. Do not force.
3. Set thermostat above room temperature to begin blower operation. A slight delay will occur before the blower comes on. Allow blower to run for 5 minutes for combustion chamber purge cycle. If blower does not come on or stops before ignition cycle, go to shut down and contact your dealer or a local recreational vehicle service agency.
4. After 5 minutes, move thermostat lever below room temperature. Blower will remain on. Wait approximately 2 minutes for blower to go off.
5. Open manual shut-off valve (if so equipped) or the valve at the outside LP tank. Correct operating characteristics depend on the valve being positioned fully open. Never attempt to operate with a valve partially closed.
 - Note: This furnace is equipped with a valve shut-off switch. With switch in OFF position, gas will not flow to burner nor will the furnace operate.
6. Set thermostat lever to desired setting.
 - Note: Motor will not come on instantly. Allow approximately 30 seconds for motor operation gas flow and sparks.

7. Allow 30 seconds for main burner to light after blower comes on. This furnace is equipped with an ignition device which automatically lights the burner. Do not try to light the burner by hand.
8. If burner does not light, repeat Steps 1 through 7.
9. If after three (3) attempts with no ignition, go to shut down and contact your dealer or a local recreational vehicle service agency. Do not continue to cycle furnace through thermostat in an attempt to get ignition.
 - Note: If furnace should lock out, the blower will go off in 5 minutes and remain off until unit is reset by reactivating thermostat.

Maintaining and Cleaning

You, as the owner/user, should inspect the furnace monthly during the heating season for presence of soot on vent. Operating the furnace under this condition could lead to serious property damage, personal injury or loss of life. If soot is observed on the vent, immediately shut furnace down and contact a qualified service agency.

[There are] several safety related items that you should follow during the heating season to assure continued safe operation of the furnace. [For a complete list of these items, refer to your product's user manual in Newgle.]

Source(s): Suburban User's Information Manual for SF, SFV, SH, and SHD Models

Product(s): This source is associated with more than one product. Refer to Newgle for more information about the product(s) offered for your coach's model year.



Thermostats

Keep your coach comfortable no matter where you are. Whether it's cold or hot outside, on the inside, you will always be "just right" using your coach's thermostat.

Dometic Comfort Control Center II Thermostat Operation (Model: CCC II / CCC 2)

This article provides an operational overview of the Dometic Comfort Control Thermostat (Model: CCC II / CCC 2).

Your CCC 2 thermostat is equipped with a liquid crystal display (LCD) that identifies the mode of operation, temperature set-point, zone identification, fan speed, program "1" and "2", inside temperature, clock, °F / °C, compressor delay, and filter maintenance. The modes of operation viewed in the LCD will vary depending on the system installed in your RV.

To help familiarize yourself with the operation of the CCC 2 thermostat, review the following diagrams and accompanying text that explain the functional characteristics of this system.

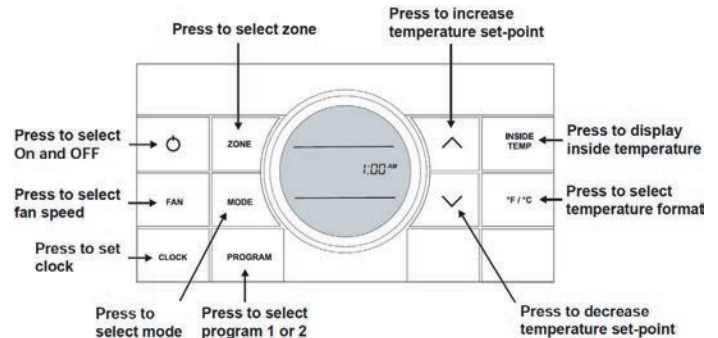

Control Buttons and LCD Icons

ON/OFF (POWER)

To turn ON the CCC 2 thermostat when the back light is OFF, first press any button to wake up the CCC 2 thermostat. Then press and release the ON/OFF button. The LCD will display the last programmed settings. To turn OFF the CCC 2 thermostat press the ON/OFF button and release. Only the time of day will display when the CCC 2 thermostat is in the OFF condition.

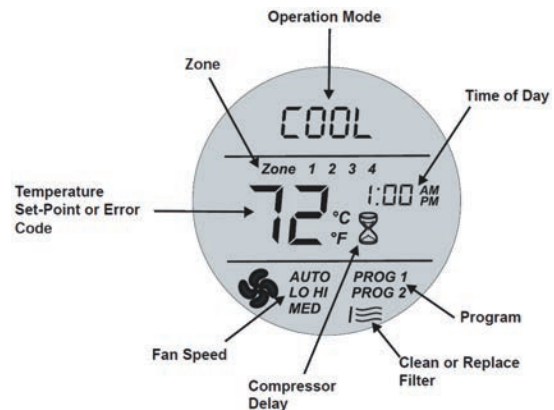

FAN

Press the FAN button to select the desired fan speed. Each successive press will advance to the next available speed. Your selections will be “Auto”, “LOW”, “MED”, and “HIGH”. The fan will run continuously during “LOW”, “MED”, and “HIGH” fan settings. The fan will cycle ON and OFF with the thermostat on “AUTO” setting.

CLOCK

Press the CLOCK button to initiate the clock setting sub-menu on the CCC 2 thermostat. When in this menu, the hour digits will flash first. The hour can be adjusted using the ▲ or ▼ buttons. Press the CLOCK button again and the minute digits will flash, allowing the minute setting to be adjusted using the ▲ or ▼ buttons. Press it a third time and the AM or PM icon will flash, allowing the AM or PM setting to be adjusted using the ▲ or ▼ buttons. Press it one more time to store the new time in memory and exit the clock setting sub-menu.

ZONE BUTTON

Press the ZONE button to cycle the LCD display through the available zone selections; “Zone 1”, “Zone 2”, “Zone 3”, and “Zone 4”. Only the available zones installed within your system will display.

MODE

Press the MODE button and the LCD will display the first available mode. Each successive press will advance to the next available mode. Continue to press the MODE button until the desired mode appears. Depending on the systems installed, your choices will be “OFF”, “COOL”, “AUTO”, “HP”, “FURN” or “AQUA”, “HS”, and “FAN”.

- OFF = off
- COOL = setting for air conditioning
- AUTO = allows the thermostat to determine to use one of the heating options or cooling option to maintain a set temperature
- HP = heat pump setting to use A/C to heat instead of cool
- FURN = furnace setting to use the furnace for heating
- AQUA = coaches with Aqua Hot heating systems for heat instead of a furnace
- HS = heat strip (Newmar does not use this function, so it is likely that this option will not show up on the thermostat; however, if the dip switch for the heat strip is turned on, it will appear)
- FAN = fan only allows you to use the fan to move air without heating or cooling

TEMPERATURE SET-POINT

Press the ▲ or ▼ button to change the temperature set-point. The temperature set-point is indicated by (2) digits on the LCD. Press the ▲ button to increase and the ▼ button to decrease the temperature set-point. The maximum set-point for the system is 90 °F (32 °C). The minimum set-point is determined by the active operating mode. For heating, the minimum is 40 °F (4 °C) and minimum for cooling is 55 °F (13 °C).

TEMPERATURE FORMAT °F / °C

Press the °F / °C button to switch between Fahrenheit and Centigrade format. “°F” indicates Fahrenheit and “°C” indicates Centigrade.

INSIDE TEMPERATURE

Press and hold the INSIDE TEMP button and the LCD will display the current inside temperature recorded at the CCC 2 thermostat (or at the optional remote indoor temperature sensor) instead of the temperature set-point. The LCD will also display “IN” to indicate that the inside temperature is being displayed. When the INSIDE TEMP button is released, the LCD will return to the programmed temperature set-point.

Care and Maintenance

IMPORTANT

Periodic cleaning or replacement of the air conditioner/heat pump air filters is required. NEVER run the air conditioner without the air filter in place. This may plug the unit evaporator coil with dirt and may substantially degrade the performance of the unit over time.

When a system fan run time exceeds 1000 hours, the filter icon is displayed on the LCD. When this occurs, wash the filter with soap and warm water. Let dry and reinstall.

To reset the fan run time and clear the filter icon, hold the INSIDE TEMP and °F/°C buttons for 3 seconds. This will clear the fan run time for the current zone selected.

NOTE FROM NEWMAR

This procedure may need to be completed on each zone.

Source(s): Dometic Comfort Control Center 2 Thermostat Operating Instructions (REV B, 08/16)

Product(s): Dometic Comfort Control II Thermostat (Model: 3314082, Newmar Part Number: 142252)

This page is intentionally blank.

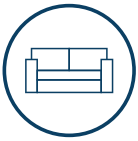

INTERIOR

This chapter provides detailed information about the furniture, cabinetry, flooring, fabrics, window coverings, and all of the interior accessories and finishing touches that turn your coach into a home.

IMPORTANT

Any of the following quick start instructions provided by Newmar should not take the place of the manufacturer's complete documentation. Refer to Newgle for more information about interior components offered for your coach's model year.



Beds and Mattresses

Several styles and sizes of beds and mattresses are available depending on your coach floorplan, such as pillow top and air mattresses. Your bed platform lifts to provide an additional convenient storage area. A strap may be provided to help raise the lid of bed base and is held open by pressurized struts to allow hands-free access.

Air Mattress Operation

This article provides basic operation instructions for an air mattress.

Air Mattress Operation with Built-In Pump



To inflate the air mattress:

1. Unstrap and unfold the air mattress.
2. Open up the pump cord storage, and route the plug to a nearby 120 volt outlet.
3. Turn the arrow, and turn the switch on to inflate the air mattress.
4. When full, the sound of the pump will change. Turn the switch off.
5. Place the air mattress on the bed.

To deflate the air mattress:

1. Rotate the dial to deflate the air mattress.
2. Turn on the pump, allowing it to remove the air from the mattress.
3. When deflated, the sound of the pump will change. Turn the switch off.
4. Unplug and store the power cord.
5. Fold up the mattress.

Air Mattress Operation with Separate Pump

Some air mattresses are equipped with a U.L. approved electric inflation pump that plugs into a standard 11v household outlet. Position your sleep sofa so that accessing an electrical outlet is convenient.

To inflate the air mattress:

1. Route the pump plug to a nearby 120 volt outlet.
2. Remove the valve cap on the air mattress by simply turning it counter clockwise.
3. After the cap is removed, insert the pump motor, and turn it clockwise until pump is engaged.
4. Allow the pump to inflate the mattress until the desired firmness is reached.
5. Remove the pump and replace the valve cap. A motor pitch change occurs when the mattress is full.
6. Replace the valve cap after inflation and seal valve by turning clockwise.



To deflate the air mattress:

1. Open the deflation valve by lifting the valve latch. Allow the mattress to deflate before folding.
2. Swing the valve to the closed position (do not lock).

WARNING

Air trapped in mattress by locking valve could cause damage. Do not lock valve while mattress is folded.

Glideaway ComfortBase Adjustable Bed Operation (Model: Freestyle)

This article provides an operational overview of the Cass Hudson Drop Down Bunk Bed installed above the cockpit chairs in some coaches. The bed lift system stows the top bunk in the travel position at the ceiling. This article provides basic operation instructions for a Glideaway ComfortBase Adjustable Bed (Freestyle).

REMOTE CONTROL

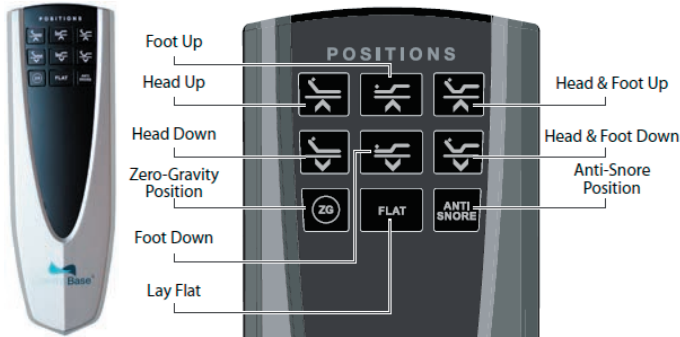

1. Press and hold the Head Up button to raise the Head position. Release button when desired position is reached.
2. Press and hold the Head Down button to lower the Head position. Release button when desired position is reached.
3. Press and hold the Foot Up button to raise the Foot position. Release button when desired position is reached.
4. Press and hold the Foot Down button to lower the Foot position. Release button when desired position is reached.
5. Press and hold the Head & Foot Up button to raise both the Head and Foot positions. Release button when desired position is reached.
6. Press and hold the Head & Foot Down button to lower both the Head and Foot positions. Release button when desired position is reached.

7. Press the Zero Gravity button and the Head/Foot positions will go to the Zero Gravity position. This action can be stopped at any time by pressing another button.
8. Press the ANTI-SNORE button and the Head position will go to the Anti-Snore position. This action can be stopped at any time by pressing another button.
9. Press the FLAT button and the bed will level. This action can be stopped at any time by pressing another button.

CAUTION

EMERGENCY LOWERING: If you cannot find the remote control to lower base, locate and press the red Sync Emergency Lowering button located on the main control box. The LED light around the button will turn red and the bed will stop.



Source: ComfortBase Freestyle Owner's Manual

Cass Hudson Cockpit Drop Down Bunk Bed Operation

This article provides an operational overview of the Cass Hudson Drop Down Bunk Bed installed above the cockpit chairs in some coaches. The bed lift system stows the top bunk in the travel position at the ceiling.



Operation

TO STOW THE BED

1. Grasp the bed assembly firmly, and push up until both side latches are securely locked into place.

TO USE THE BED

1. Press the switch to release the latch.
2. Grasp the bed assembly firmly and pull down until it stops.
3. Hang the bunk ladder.



CAUTION

Ensure that the areas above, below and adjacent to the bed are free from obstructions before operating the bed. Properly secure loads in the bed area to avoid damage to the bed mechanism from shifting or falling loads.

▲ IMPORTANT

Raise the bed(s) to the FULL UP position when traveling to avoid damage to the bed as a result of bouncing.

Safety Precautions

Coaches equipped with a drop down bunk bed may have labels adhered to a surrounding area to provide special instructions or weight capacities. Acknowledge and follow all warning labels to prevent any damage to equipment or personal injury. The following labels are examples only. Actual instructions and weight restrictions may vary.

▲ WARNING

On coaches equipped with a flip-down bunk or bunk bed lifts, NEVER operate the bed(s) with person(s) or object(s) on the bed platform or travel with any object(s) other than bedding on the beds.

▲ WARNING

To help prevent serious or fatal injuries from entrapment or falls:

- Never allow a child under 6 years on upper bunk
- Use only a mattress that is _____ inches long and _____ inches wide on upper bunk
- Ensure thickness of mattress and foundation combined does not exceed _____ inches and that mattress surface is at least 5 inches below upper edge of guardrails

DO NOT REMOVE THIS LABEL

CAUTION

250 lbs.

Maximum load capacity

KRV015



Cabinetry and Woodwork

Cabinetry and Woodwork Care and Maintenance

Newmar's exquisitely crafted cabinetry newly gleams with chrome-finished hardware, the perfect complement to the array of appliances that make cooking and clean-up a breeze. Amish craftsmanship and elegance in design meld the wood cabinetry and furniture seamlessly with the Newmar interior. All Newmar cabinetry is custom built in our facility and designed with function and convenience in mind, as well as to provide as much storage as possible in your coach.

Construction

All joints on Newmar hardwood cabinets are glued, and then screwed together for extra durability. Hardwood raised panel cabinet doors are standard throughout the coach. Depending on your coach model, you may have hardwood cabinets or vinyl veneer finished cabinets. A variety of vinyl veneer and stain finishes are available for the cabinetry. A hand-sanded finish helps minimize seams so your hardwood cabinetry is as beautiful as it is durable. Metal drawer guides provide a smooth opening and closing of the drawers in your coach. To open a drawer, lift up slightly and pull open. This feature helps prevent the drawers from opening during transit. Your unit may also include features such as adjustable pull out pantry boxes in the kitchen, soft-close drawers, or a molded silverware divider tray for added storage.

Humidity and Climate Change

Controlling the coach environment is the first priority of cabinet care and maintenance. Wood products shrink and grow according to the environment in which they are placed. These changes are in direct relationship to the relative humidity levels. As the humidity increases, the wood expands, and as the humidity decreases, the wood shrinks. This process does not happen instantaneously the longer the wood is exposed to low humidity, the more it will shrink as it dries out, and visa versa.

Coach owners who travel around the country may be more prone to this issue, as their coach is exposed to both extreme humidity and extreme dryness. It is necessary to acknowledge the fact that wood changes according its environment. Newmar recommends maintaining relative humidity levels between the range of 35-50 percent and temperature levels between the range of 40-90 degrees. The air conditioner or a dehumidifier will reduce the humidity level; however in dry climates, a humidifier may also aid in maintaining the appropriate humidity levels by raising the humidity level. The following labels are examples of the notices that may be posted in the coach in regards to condensation prevention and formaldehyde exposure.

NOTICE

This vehicle is TSCA TITLE VI COMPLIANT and contains composite wood products that comply with the applicable California Code of Regulations Section 93120.2(a) Phase 2 (P2) formaldehyde emission standards specified on the above date of manufacture.

NI 151

NOTICE

This vehicle is designed as a Recreational Vehicle. When used for an extended period of time, while furnace heating is required, sweating and condensation conditions may occur. The following precautions should be taken to minimize these conditions:

- (1) Use range hood when cooking.
- (2) Use the bathroom power vent when bathing or showering.
- (3) Open windows slightly for ventilation whenever possible.
- (4) Use dehumidifier to keep humidity as low as possible.

NI 153

IMPORTANT NOTICE

Certain of our finest product suppliers have advised that urea-formaldehyde is used in the production of particle board, fiberboard plywood or paneling which they supply us and which we utilize in our finish product. These suppliers have requested that we communicate this to our customers.

For your information, we are reproducing samples of statements which have been provided to us by our suppliers.

WARNING: THIS PRODUCT CONTAINS A UREA-FORMALDEHYDE RESIN AND MAY RELEASE FORMALDEHYDE VAPORS IN LOW CONCENTRATIONS. FORMALDEHYDE CAN BE IRRITATING TO THE EYES AND UPPER RESPIRATORY SYSTEM OF ESPECIALLY SUSCEPTIBLE PERSONS SUCH AS THOSE WITH ALLERGIES OR RESPIRATORY ALLEGMENTS. PROPER VENTILATION SHOULD REDUCE THE RISK OF SUCH PROBLEMS. IF SYMPTOMS DEVELOP, CONSULT YOUR PHYSICIAN.

Adams, Inc.

WARNING - IRRITANT: THIS PRODUCT CONTAINS A UREA-FORMALDEHYDE RESIN AND MAY RELEASE FORMALDEHYDE VAPORS IN LOW CONCENTRATIONS. FORMALDEHYDE VAPOR MAY IRRITATE SOME PEOPLE, CAUSE HEADACHES, EYE, NOSE, AND THROAT IRRITATION AND AGGRAVATION OF ALLERGIES AND RESPIRATORY PROBLEMS, SUCH AS ASTHMA. PROPER VENTILATION SHOULD REDUCE THE RISK OF SUCH PROBLEMS.

Robert Wood Johnson Corp.

Ventilation is important in maintaining a comfortable environment and we direct your attention to the measures of ventilation contained in your Owner's Manual.

⚠ NOTICE

Hardwoods may change color or darken when exposed to sunlight. It is important that the window shades be down during long periods of storage. Changing shades of color, or discoloration, from exposure to sunlight is not a warrantable repair, as it is the nature of the hardwood products in your coach.

Care and Maintenance

The cabinetry should be wiped down with furniture polish to sustain the natural beauty and luster of the wood.

⚠ IMPORTANT

As with any wood product, do not saturate these cabinets with water or any other liquid. Be sure to wipe up spills as they occur to avoid staining.

Kitchen Cabinet Extension, Peninsulas, and Islands Overview

This article provides basic information about kitchen extensions, peninsulas, and islands.

Pull-Out Cabinet Extensions

The cabinet “extension” is incorporated directly into the kitchen cabinetry, and glides out on drawer guides to provide additional counter space when needed.



Pull-Out Cabinet Extensions Example

COACHES BUILT IN OR AFTER 2017

Most 2017 and newer coaches are equipped with a counter extension and an electric latch release. To extend the counter:

1. Turn on the coach battery disconnect.
2. Extend the slideout.
3. Press the button right above the pull-out island (between the counter extension and the main countertop) to release the island extension.
4. Pull out on the extension until the magnetic catches engage.

To retract the counter, push in the extension until it latches.

COACHES BUILT PRIOR TO 2017

On older coaches, unlock the extension by accessing the lever located in the top drawer.

⚠ CAUTION

All pull-out cabinets must be secured prior to transit, as damage to the cabinetry and/or interior of the coach, or physical injury, may occur.

Stationary Peninsulas

The stationary peninsula provides additional storage and countertop space. The kitchen slideout extends and retracts around the peninsula while it stays in place.

⚠ IMPORTANT

Make sure the countertop is clear of obstructions or debris in the path of the slideout before extending or retracting the slideout. Do not allow any objects to fall between the peninsula and the slideout, as they may cause damage.



Stationary Peninsula Examples

Stationary Islands

The island provides additional storage and countertop space. The stationary island may house the central vacuum system, as well as crucial plumbing and electrical fixtures.

⚠ IMPORTANT

Make sure the areas around the island are clear of obstructions or debris and all cabinet doors are securely closed before retracting the slideouts.



Stationary Island Example



Ceiling and Walls

The ceiling and walls in your coach are designed with more than function in mind, they are pleasing to the eye as well.

Ceiling and Walls Care and Maintenance

The ceiling in your coach may be covered with a padded vinyl ceiling headliner and should be cleaned periodically to maintain a new appearance. Use a non-abrasive cleaner with a soft cloth. Do not use solvents of any kind, as they may damage the surface.

The decorative wall coverings can easily be maintained and are not much different from wallpaper and should be cleaned with a solution of mild soap and water or a non-abrasive cleaner with a soft cloth.

CAUTION

For stubborn spots, test any cleaner on a area that is hidden, as some cleaners may fade or discolor the wall covering. Do not use solvents of any kind, as they may damage the surface.



Countertops and Backsplashes

Solid Surface Countertop and Backsplash Care and Maintenance

This article provides proper care and maintenance instructions for solid surface countertops and backsplashes. No special cleaning products are necessary; however, the countertops and backsplashes can be damaged if they are not cared for properly.

Cleaning

The solid surface composite countertops are non-porous, so most dirt and liquids sit on the surface and can easily be cleaned with a soap or mild detergent.

IMPORTANT

Avoid using window cleaners that may leave a waxy build-up that dulls the surface.

Wipe up spills as soon as they occur. Film can also build up on the countertop if water is left to dry, making it appear blotchy and uneven. Always wipe the countertop completely dry with a soft cloth after spills and cleaning. Spray the surfaces with a hard-surface cleaner, and leave it for a few minutes before wiping clean with a damp cloth. Strong chemicals and solvents may damage the surface and should be wiped up immediately, then rinsed with water.

Avoiding Damage

HEAT

The solid surface countertops can be damaged with excessive heat or the use of harsh chemicals. Never put hot pans directly on the counter or in the sink. Avoid pouring hot liquids directly into a solid surface sink; run cold water while pouring hot liquid into the sink to avoid damage. If possible, allow the pan or pot to cool first.

Use caution when using heated appliances, such as crock-pots, electric frying pans, toaster ovens, etc. When possible, never use these appliances directly on the countertop.

IMPORTANT

Always use a heat pad or trivet to protect the surface from heat that may mar or damage the surface.

SCRATCHES

Try not to cut or chop food directly on the countertop, as you can score and scratch it. Slight abrasion marks may occur during normal daily use; cleaning regularly will ensure the durability and longevity of the countertops. Darker and heavily pigmented colors may show wear and tear more readily, and may require additional or more frequent maintenance.

IMPORTANT

Always use a cutting board when cutting or chopping. Never cut or chop food directly on the countertop.

Some deep scratches can be sanded out, and defects in solid surface countertops can be repaired, by trained professionals.

CHEMICAL SPILLS

Strong acids and cleaners may discolor the surfaces and should be wiped up immediately and cleaned with soapy water to prevent damage to the surface. Prolonged exposure may require professional repair or replacement.

Countertop Extension Operation

This article provides an operational overview of the countertop extension.

To Raise The Countertop Extension Leaf:

- Lift up on the extension.
- Pull down on the support bracket to latch each support.

To Lower and Store The Countertop Extension Leaf:

- Lift up on the extension to take the pressure off of the support brackets.
- Fold the support brackets.
- Lower the extension until it is completely folded down.



Fabrics and Materials

Newmar uses only the most highly regarded names in residential décor to make their finest luxury coach a reality. High-quality fabrics are used throughout your coach, including the bedspread, shams, accent pillows, draperies, headboard, valances, and much more.

Dash Material Maintenance

This article provides suggested maintenance instructions for the dash material. In order to keep the dash in like-new condition, follow these guidelines:

Do-

- Dust and clean the dash with a soft, damp cloth, or chamois, wiping the surface gently.
- Use a mild detergent and lukewarm water.
- Dry the surface, after washing and rinsing, by blotting with a damp cloth or chamois.

Do Not-

- Use harsh chemicals that may damage the dash.
- Use cloths containing grit or abrasive particles or kitchen scouring compounds to clean or dust the dash.
- Subject the dash to hard, direct blows.
- Use boiling water or strong solvents to clean the dash, as they will soften the plastic.

Fabrics and Materials Care and Maintenance

This article provides care and maintenance recommendations for the fabrics and materials installed in a Newmar coach.

The fabrics used in your coach may contain fire-retardant additives that may be damaged by use of improper cleaning products. Cleaning instructions for these items are DRY CLEAN ONLY. Water-based products are not recommended for cleaning the fabrics in your new unit. Most water-based household cleaning products are not formulated for use on these fabrics and may cause excessive shrinkage or fading. For best results, the fabrics in this unit should be cleaned by a professional carpet and upholstery cleaner.

⚠ IMPORTANT

The fading of upholstery, carpet and other interior fabrics can be caused by excessive sunlight. The drapes, blinds, or shades should be kept closed if the coach will be parked for an extended period of time to minimize fading. Normal deterioration due to wear and/or exposure to sunlight is not covered by the Newmar Limited Warranty.

Spills, spots, or stains should be treated as soon as possible to avoid permanent damage. If a spill occurs, blot the fluid with a dry towel. Do not rub the spill. Rubbing may cause the liquid to “set” in the fabric. When attempting to clean a spot or stain, always start from the outside and work inward to avoid spreading it further.

⚠ IMPORTANT

Some stains or soils are extremely difficult or impossible to be removed completely. These should receive immediate, professional attention. Spills, spots, stains or soils are the responsibility of the owner, and are not covered by the Newmar Limited Warranty.

⚠ WARNING

When cleaning the upholstery and fabric in the unit, do not use lacquer thinner, nail polish remover, laundry soaps, or bleach. Never use carbon tetrachloride or gasoline for cleaning purposes. These items may cause damage to the materials being cleaned, and most are highly flammable.



Flooring

Flooring – both tile and carpet – is installed with Newmar’s own in-house process, ensuring the best in quality and longevity, as well as the finest fit. The flooring in every Newmar coach — from our high-quality, durable tile to the plush, luxurious carpeting— is placed with the highest level of care.

Carpet Care and Maintenance

This article provides care and maintenance recommendations for carpet. The installed carpeting is made of synthetic materials, mostly nylon fiber and is easy to maintain.

Vacuum regularly to remove dirt, dust, lint, and other abrasive grit. Water-based spills and spots should be soaked up and removed immediately with a damp cloth. Grease or oil based stains and spots should be spot cleaned with a commercial spot cleaner intended for this purpose.

When complete shampooing is desired or necessary, it is best to have it done by a professional carpet cleaner. Wait for the carpeting to dry thoroughly before walking on it.

⚠ IMPORTANT

Do not soak or water-log your carpeting.

⚠ IMPORTANT

In carpet areas that receive the most sunlight, close the curtains, blinds, or shades to prevent fading.

⚠ IMPORTANT

Act quickly to clean up when anything is spilled or dropped on the carpet.

⚠ IMPORTANT

Slideout rollers may leave indentations in the flooring. This condition is normal and does NOT warrant flooring replacement.

Vinyl Flooring Care and Maintenance

This article provides care and maintenance recommendations for vinyl flooring, which is placed with the highest level of care.

For routine cleaning, sweep or vacuum regularly. Then, use a damp mop with warm water to clean a small area at a time. Rinse the mop frequently as to not redistribute the picked up dirt. If washing is needed, use a product designed for no-wax flooring.

⚠ IMPORTANT

Do not use solvent-based waxes or polishes, as damage to the flooring may result.

⚠ IMPORTANT

Slideout rollers may leave indentations in the flooring. This condition is normal and does NOT warrant flooring replacement.



Interior Doors and Hardware

The interior doors add to the beauty and privacy of your coach. Newmar installs a variety of functional doors from the basic hinged-swinging door, recessed hardwood pocket doors, and even pivoting doors on select floorplans. Each interior door is designed to fit and function for trouble-free operation.

⚠ IMPORTANT

Always secure all interior doors prior to travel to prevent damage to the doors and any surrounding objects.



Interior Furnishings

Interior furnishings such as clocks, artwork, and other decorations help make your coach feel like home. Other furnishings may be installed to provide the essentials and the amenities for your convenience while traveling.

Interior Furnishings Overview

Pictures, Clocks, or Wall Art

Most pictures and wall art installed at the factory have a hanger at the top and Velcro at or near the bottom. There may also be Velcro on the sides. To remove the picture or wall art, pull the Velcro loose at the bottom and sides, and then remove it from the hanging device. Some decorations without a frame may have exposed screws that may be difficult to find. For this type of decor, locate the screws, and remove them.

Furniture Overview

Covered in coordinating fabrics and accented with pillows, a variety of furniture is available in your coach depending on coach model and floorplan as well as the options that were ordered. Options may include recliners, theater seating, sofa beds, dinettes, and booths. Your furniture is designed with function and style in mind. Many of the furniture pieces are multifunctional and may recline, turn into sleeping areas, open to access hidden storage areas, etc. Any furniture that has seatbelts installed from the factory have been tested and are intended only to be used in the seating position when the slideouts are in the retracted position for travel.

⚠ WARNING

Do not attempt to use recliners, theater seating or any furniture that opens or reclines and changes from the basic seating position unless the coach is in the set-up position (i.e., parked and with the slides open). Otherwise, occupants may become injured, and furniture and surrounding items may become damaged.

Driver and Passenger Seat Overview

This article provides an overview of driver and passenger chairs installed on a Newmar coach.

⚠ IMPORTANT

This article is intended to provide a basic overview of the driver and passenger seats and is NOT all-inclusive of available features on any one particular seat. Chair manufacturers, styles, and features vary by coach. Seat features may be controlled via rocker or joystick-style switches, levers, knobs, or buttons. For additional information about driver and passenger seat operation, refer to Newgle.

The fabric and color of the chairs is based upon the décor package selected at the time of production. The driver and passenger seats may be standard or wide-width and are covered in vinyl or leather. Some coach models feature branded seats with the logo of the coach model. Other variations may include notched arms and/or skirt panels. The seats have a three-point seat belt, which may be integrated into the seat. Some seats may also be operated via a remote control with additional features.

Standard and Optional Features of Driver and Passenger Chairs

ADJUSTABLE BASE

Chairs may have a powered or manual adjustable base. Powered driver and passenger front seats are mounted on power pedestals that offer a wide range of adjustments. A joystick-style switch typically moves the seat horizontally and vertically, a rocker switch tilts the front of the seat up and down, and another switch often controls the tilt of the rear of the seat base. Additional switches or knobs, depending on the coach year and model, control the recline angle of the seat back.

SWIVEL

When the coach is not in motion, some seats may have the option to swivel (turn around) to face the living room of the coach via a release lever on the pedestal. Before turning the chairs, follow this procedure:

- First extend the slideout room.

- Tilt the steering wheel up and toward the dash.
- Position the armrest to provide maximum clearance.
- Straighten the seat back.
- Move the seat forward or backward to provide enough clearance for the steering wheel. Additional adjustments may be necessary during this process.

Once these steps are completed, the chairs will swivel without interference.



ADJUSTABLE LUMBAR SUPPORT

Some driver and passenger seats may be equipped with a lumbar support in the lower back region of the seat. The power lumbar control switch is located on the side of the seat and can be used to adjust the lumbar portion of the seat. This setting determines the amount of pressure applied to the user's lower back.

FOOT REST

Some driver and passenger seats feature a manual or power foot rest. If equipped, powered foot rests may be extended or retracted via a control switch located on the seat.

ADJUSTABLE ARMS

Some driver and passenger seats have adjustable arms that can be raised or lowered based on the user's preference. These can often be adjusted via a lever located on the armrest. Some arm rests automatically move when adjustments are made to the angle of the seat back.

Folding Cockpit Table with 152803 Mechanism Overview

This article provides basic operation instructions for a folding cockpit table.

To Convert The Drink Holder Into A Table:

1. Push the lever toward the arrow to unlock the mechanism.
2. Pull out on the table to slide it away from the dash.



HEATED SEATS

Some seats may feature heat, which can be controlled via remote control (if equipped) or a switch located on the base of the seat. This switch is often red in color and/or has a graphic with upward moving "heat rays." Seats equipped with a remote control have adjustable heat settings.

COOLED SEATS

Seats may have adjustable cooling settings via a control switch located on the seat base or remote control.

SEAT MEMORY

Select coaches may be equipped with a memory package that allows you to set and store up different combinations of seat, steering wheel, pedal, and exterior rear view mirror positions for up to three drivers. For more information about the driver control memory system, refer to Newgle.

MASSAGE

Seats equipped with a remote control may have various massage modes and intensity settings.

HAPTIC FEEDBACK

This feature is used on coaches with a Mobileye lane departure warning system. The seat will vibrate to notify the driver if the coach leaves the intended lane.

Troubleshooting

If you experience issues with your power seats, please refer to the Fuse Panel portion of Newgle. Select your coach year, model, and floorplan to view the appropriate fuse location diagrams. These will often prove to be helpful when locating your fuse panels, positions, and ratings.

- Grab the table assembly at the back and pull up, raising it into a vertical position.



- Lift both portions of the table at the lower end, and rotate it upward until the drink holder is flat but elevated at table top height.



- Flip the top leaf with the drink holder 180° to fully open the table. The drink holder should now be facing the floor, and the table top should be flat.



To Convert The Table Holder Into A Drink Holder:

- Reverse the procedure to fold the table back into the drink holder position and lock in place.

⚠ IMPORTANT

Only use this table while the coach is in the park position.



Interior Steps and Step Covers

On select coaches, the switch for the interior step cover is located either on the side of the passenger console or on the dash console near the center. This cover allows you to freely walk inside of the coach without having to be on the steps while in transit or when parked for longer periods of time. In addition, select coaches are equipped with step treads that can be lifted for additional storage.

Stepwell Storage Overview

This article provides an overview of the stepwell storage provided on some coaches. Select coaches are equipped with step treads that can be lifted for additional storage.

⚠ CAUTION

Make sure all stored contents fit entirely inside of the step box. Raised step treads or loose items in the stepwell can create a trip or fall hazard.



Shades and Window Coverings

Power Windshield Shade Operation

This article provides basic operation instructions for a Power Windshield Shade.

IMPORTANT

Do not manually pull down on the power shades, as damage may result.

Visor/Shade (Day Shade)

The Visor switch is located on the dash and adjusts the windshield screen up or down. When the ignition switch is turned on it limits the visor travel to approximately 1/2 way down and with the key off it travels all the way down to the dash. The screen will travel up until it reaches the stop setting.



1. With the ignition on, press and hold the switch in the down direction to extend the drape to the ignition stop set limit, which is approximately half-way. This is to allow the driver to see out the window.
2. With the ignition off, press and hold the switch in the down position to extend the drape until it reaches the “down” stop set limit.
3. With the ignition on or off, press and hold the switch in the up position to retract the drape until it reaches the “up” stop set limit.
4. Release the switch during travel to stop the drape extension or retraction between the “up” and “down” stop set limits.

Front Privacy Drape / Shade (Night Shade)

Press the UP or DOWN button for the appropriate shade. Switches may be labeled “Front Privacy Drape” or “Shade.” Switch-operated shades require the switch to be held until the shade either reaches its limit or the desired intermediate position (the shade can be stopped at any point by simply releasing the switch).

The switch labeled “Front Privacy Drape” or “Shade” is located in the overhead cabinet or on the dash and adjusts the windshield shade up or down.



Manual Day and Night Shade Operation

This article provides basic operation instructions for the manual day and night shades.

Day Shades

The first section visible when closing the shade is the “DAY” section. This material is translucent. Sunlight passes easily through the material into the unit while allowing a degree of privacy.



TO LOWER THE DAY SHADE:

- Grasp the shade near the center, and gently pull it down to the desired position.
- Release it slowly and gently to maintain the desired position.

TO RAISE THE DAY SHADE:

- Quickly pull down the shade and gently release it, allowing it to retract. If necessary, hold on to the bottom to control the speed of the retraction.

Night Shades

The second visible section is the “NIGHT” section. This material is a heavier, more opaque material. Very little to no light passes through it, so these shades are generally used in the evening or when more privacy is desired, though under certain light conditions, it can cast shadows and silhouettes.

TO LOWER THE NIGHT SHADE:

- Grasp the shade near the center, and gently pull it down to the desired position.
- Release it slowly and gently to maintain the desired position.

TO RAISE THE NIGHT SHADE:

- Quickly pull down the shade and gently release it, allowing it to retract. If necessary, hold on to the bottom to control the speed of the retraction.

This page is intentionally blank.



PLUMBING

This chapter provides detailed information about the coach's fresh and waste water system and all of the related components: faucets and fixtures, filters, sinks and showers, toilets, and much more.

IMPORTANT

Any of the following quick start instructions provided by Newmar should not take the place of the manufacturer's complete documentation. Refer to Newgle for more information about plumbing components offered for your coach's model year. Failure to connect and operate the system correctly may result in damage not covered by the Newmar Limited Warranty.

Plumbing Overview

About The Fresh Water System

The Fresh Water System consists of the fresh water holding tank, water pump, valves, connection hoses, and fresh water plumbing lines. This system is responsible for providing potable water for drinking, cooking, bathing, and all other activities that require clean water.

The fresh water system begins with a hose or hose reel, which provides the connection to the fresh potable water. Then, via the fresh water valve, the water is diverted through the coach to be distributed through the cold water plumbing lines to the fresh water holding tank or to the cold water connections of each faucet and the water heater. From the water heater, the water is then dispersed through a series of water lines to each faucet on the hot water inlet and the hot water spigots (if equipped).

About The Waste Water System

There are two separate waste systems: the gray tank system and the black tank system, which includes sinks, lavatories, showers, tubs, and toilets. Each tank has its own control valve, and both tanks drain through the sewer drain hose. The waste water system catches and contains the used water and divert the waste water through the traps and drain lines to the grey or black holding tank(s). It is then stored until the tanks are emptied using a sanitary drain or dump station.

CAUTION

Read and understand all operating instructions for the plumbing system prior to using your coach. Failure to connect and operate the system correctly may result in damage not covered by the Newmar Limited Warranty.

2022 Bay Star Water Compartment Overview

This article provides a general breakdown of the components installed in a 2022 Bay Star water compartment.

Overview

The water compartment in the coach typically contains the tanks and most of the controls for the plumbing system. It is usually located on the driver side of the coach immediately in front of the rear wheels, as it is isolated from other compartments and is heated and insulated. The water compartment contains parts of both the fresh and waste water systems.

IMPORTANT

Some plumbing components may be located in other compartment(s) and may not be mentioned in this article or labeled in the graphic.

WATER PRESSURE REQUIREMENTS

Ease of operation was the key element in the design of the water compartment and plumbing systems. The fresh water system in your coach is designed to operate at a maximum of 60 PSI. Water pressure levels above this level can damage the fresh water plumbing. If the water pressure ever surpasses 60 PSI, a pressure regulator must be installed to reduce the incoming pressure, or fill the fresh water tank and use the internal water pump to supply water to your coach.

Example Of A 2022 Bay Star Water Compartment

The following information is generic for the 2022 Bay Star. Components installed may vary by floorplan or optional equipment.

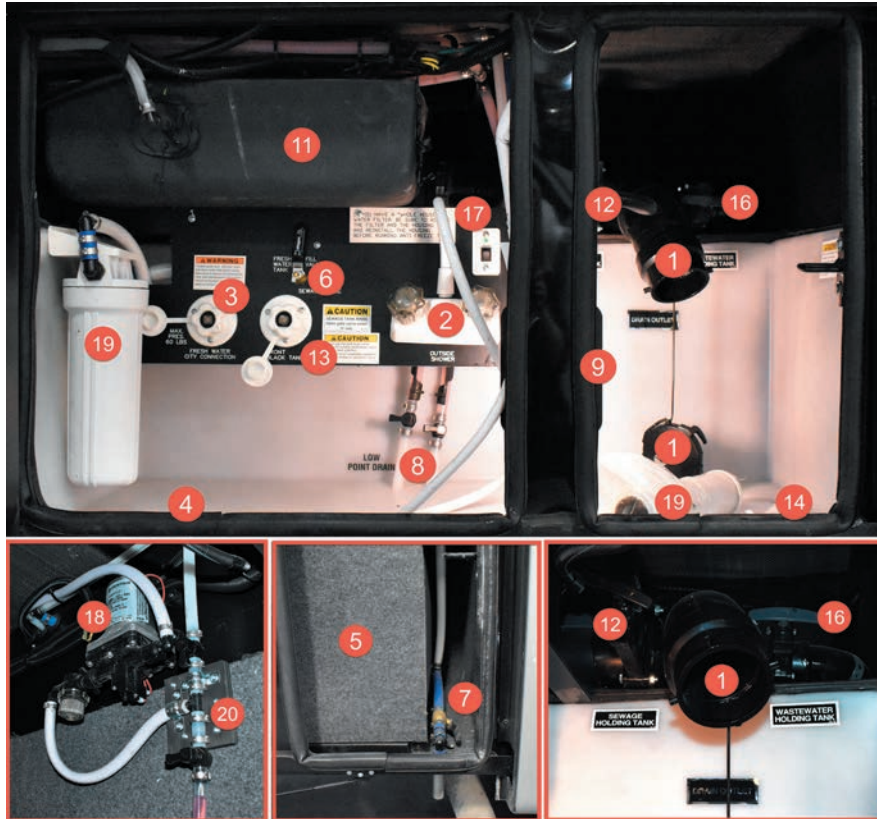

COMPONENTS NOT PICTURED (OR LOCATED IN OTHER COMPARTMENTS):

- 5** Fresh Water Tank
- 15** Waste (Gray) Water Tank
- 7** Fresh Water Tank Low Point Drain
- 18** Water Pump with Filter
- 10** Saniflo Lift Station Pump
- 20** Winterizing & Antifreeze Inlet Valves (A & B)

COMPONENT(S)	SUMMARY OF FUNCTION AND OPERATION
1 Drain Outlet and Cover	The drain outlet is used to attach a 4" sewer hose, and the drain cover is used to prevent leakage of waste material. Make sure the drain cover is securely installed on the drain outlet unless actively dumping the tanks via a 4" sewer hose.
2 Exterior Shower	An exterior shower faucet with a wand can be used to rinse off shoes and/or feet, bathe a pet, wash your hands, or rinse off the sewer hose after dumping the waste water tanks. When finished using the exterior shower, shut off both the hot and cold valves. Do not simply shut off the valve on the shower head itself, as it may cause hot and cold water to mix at the exterior shower and could allow drastic changes in water temperature throughout the coach.
3 Fresh (City) Water Connection via Hose	This potable water connection is used in conjunction with the Fresh Water Fill Valve for a number of purposes, including pressurizing the plumbing in the coach and filling the fresh water tank. Connect the coach to the water source via a potable hose and the city water connection.
4 Fresh Water Hose Hatch	The hatch provides an opening in the compartment floor to insert the potable water hose to prevent the compartment door from crushing the hose when the door is closed.
5 Fresh Water Tank	This tank is used to hold fresh potable water for use throughout the water system and is usually located on the floor of the water compartment; however, some coach floorplans may be equipped with a water tank located in another compartment. The fresh water tank is filled from the city water connection with a hose or hose reel via the fresh water tank fill valve or auto fill system. This tank may be located behind a panel, cover, or the macerator and may not be visible from the outside.
6 Fresh Water Tank Fill Valve	The rotating fresh water tank fill valve is used to pressurize the fresh water system in your coach, as well as to fill the fresh water tank when the coach is connected to city water. With pressurized water supply connected, simply rotate the valve to the desired position: <ul style="list-style-type: none"> • Manual fill position fills the fresh water tank when connected to a pressurized water source • Auto fill position supplies pressurized water to the coach on demand from the city water connection and, if the auto fill function is enabled on the coach's tank monitoring system (i.e. Silverleaf, KIB, or Digi-Level), fills the fresh water tank to match the auto fill settings.
7 Fresh Water Tank Low Point Drain	The fresh water tank low point drain is used to empty the fresh water tank. Open the low point drain valve to drain the fresh water tank, and close the low point drain valve when filling the fresh water tank or storing fresh water in the tank. This low point drain is located near the fresh water tank and may be difficult to see from the outside. It is often located just behind the lip of the white drain pan when the fresh water holding tank is located in the main water compartment. When the fresh water holding tank is located outside of the main water compartment, the fresh water tank low point drain is typically near it.
8 Hot and Cold Low Point Drains	Typically the coach has one hot water low point drain and one cold water low point drain, which are used to empty the water lines. Open the valves to relieve water pressure and drain the water lines. Close the valves for normal operation of the pressurized water system.
9 LED Pancake Light	Some lights in the compartment have built-in switches on the light housing to turn the light on and off. Other lights are operated automatically via a plunger switch that activates the lights when the compartment door is opened.

10	Saniflo Lift Station Pump	Certain floorplans may use a lift pump in locations where plumbing drains are too low or too far away for gravity drains to effectively reach the waste water holding tanks. The design is a small collection tank with an inlet from the sink or shower with a submersible pump to push the water out of the discharge to the holding tank. The pump starts automatically (if 120 volt power is being supplied) as soon as the bath, shower, or sink begins to drain. It shuts down when the water has been drained. Note: Only select floorplans are equipped with lift station pumps, which may or may not be located in the water compartment.
11	Sewage (Black) Tank	The black tank is generally for sewage waste from the stool. It is typically located between the frame rails in the water compartment. This tank may be located behind a panel or cover and may not be visible from the outside.
12	Sewage (Black) Tank Dump Gate Valve with T-Handle	In conjunction with the sewage holding tank, the sewage tank dump valve provides adequate and safe storage and/or controls the disposal of waste materials. Open the black tank gate valve all the way by pulling on the T-handle. The tank will start to drain to the macerator or drain outlet as soon as the T-handle is pulled. The 4" drain line or macerator hose should be used to direct waste to the dump station for proper disposal.
13	Sewage (Black) Tank Rinse Connection	When draining your sewer tank, attach a water hose to the sewage tank rinse connection. After the tank is drained, leave the gate valve open, and open the water valve to the attached hose, allowing water to spray inside the sewage tank for several minutes to flush and rinse the tank.
14	Sewer Hose Hatch (Access Port)	The sewer hose hatch is a removable cover that allows the sewer hose or the small macerator hose to exit through the compartment floor in order to connect to a proper dump station. This allows the compartment baggage door to close without hindrance from the hose. The cover may be threaded or clipped. Note: When routing the sewer or macerator hose through the hatch, do not place on or near the Oasis, generator, or engine exhaust pipes. Otherwise, damage may occur.
15	Waste (Gray) Water Tank	The gray water holding tank is typically located in the underbelly of the coach, sometimes on top of the fresh water tank. It is primarily used for the drainage from the kitchen and bath sinks, shower, and the washing machine (if equipped). This tank may be located behind a panel or cover and may not be visible from the outside.
16	Waste (Gray) Water Tank Dump Gate Valve with T-Handle	In conjunction with the gray (waste) water holding tank, the gray (waste) tank dump valve provides adequate and safe storage and/or controls the disposal of waste water. Open the gray (waste) gate valve all the way by pulling on the T-handle. The tank will start to drain to the macerator or drain outlet as soon as the T-handle is pulled. The 4" drain line or macerator hose should be used to direct waste to the dump station for proper disposal. Newmar recommends dumping and flushing the gray (waste) water holding tank after the black (sewage) holding tank.
17	Water Pump Switch with LED Indicator	Press the water pump switch momentarily to activate the water pump. The LED illuminates when the pump is activated.
18	Water Pump with Filter	When not connected to city water, the coach's water pump is used to pump and pressurize water from the fresh tank for distribution through the hot and cold water lines. When activated, the water pump will automatically turn on and off to maintain proper water pressure in the coach.
19	Whole House Water Filter	The whole house water filter system uses a replaceable extruded carbon filter cartridge to remove sediment and certain impurities from the incoming water supply. This filters the fresh water as it is brought in to the coach from the city water connection through the hose or hose reel.
20	Winterizing and Antifreeze Inlet Valves (A and B)	The winterizing valves are only used during the coach winterization process. To determine proper valve positioning throughout the process, follow the posted instructions in the coach water compartment for the A and B valves. These valves may be located outside of the main water compartment on some coaches.

Additional Resources In Newgle

The above definitions are summaries and only explain the basic function and operation of each component. For additional information about these components and the complete operational instructions, please refer to the following list of additional articles in Newgle.

- Auto Fill Overview
- Exterior Shower Overview
- Fresh Water Lines, Low Point Drains, and Plumbing Leaks
- Fresh Water Tank and Drain
- Fresh Water Valves
- Holding Tank Rinse (No Fuss Flush)
- Hose Reel and City Water Connection Overview
- How to Operate the Cargo Lights
- How to Winterize a Coach
- Waste Water Disposal
- Waste Water Holding Tanks
- Water Filter Care and Maintenance
- Water Pump Operation and Basic Troubleshooting

Water Compartment Heating via a Forced-Air Furnace

This article provides an overview of the water compartment heating via a forced-air furnace. Coaches equipped with a forced-air furnace have a designated heat duct for the water compartment in the basement to reduce the risk of freezing.



IMPORTANT

Heat output to the water compartment is only operational when the furnace is heating the interior of the coach.

Holding Tank Heat Pad Switches and Indicator Lights

This article provides a brief overview of the Holding Tank Heat Pad Switches and Indicator Lights. Coaches produced and equipped (after June 2015) with optional holding tank heating pads are GFCI-protected and incorporate an indicator light to the switch panel to signify that 120 volt electricity is being supplied to the heating pads.

If the indicator switch does not illuminate when you turn it on, check the GFCI outlet located in the basement compartment (the location will vary based on coach floorplan and tank placement).

The heat pad switches may be incorporated in the monitor panel in 2018 (and newer) coaches equipped with the KIB tank monitoring system.

If your coach is equipped with tank heat mats and the switch is activated, the tank heat icon will appear under the grey and black tanks. The tank level must be at least five percent for the control panel to send power to the tank heater and has a one minute delay before activation.

If the tank is equipped with a heating pad, there will be a tank indicator below the tank bar graph. When the tank heater is active, the indicator will turn orange. When inactive, the indicator will turn grey.

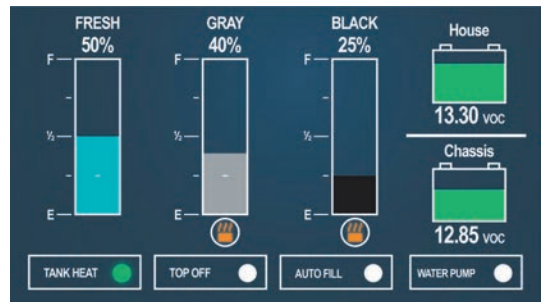

⚠ IMPORTANT

The TMSC-100 is not monitoring any temperatures; this simply activates or deactivates the heat pads.



Fresh Water System

The Fresh Water System consists of the fresh water holding tank, water pump, valves, connection hoses, and fresh water plumbing lines. This system is responsible for providing potable water for drinking, cooking, bathing, and all other activities that require clean water. The capacity of your fresh water tank may vary, depending on the coach model and year.

Fresh Water Lines and Low Point Drains Overview

This article provides a basic overview of Fresh Water Lines and Low Point Drains.

Fresh Water Lines

Fresh water lines are used to distribute potable water throughout the coach. The hot water lines are typically red in color or translucent with red lettering. The cold water lines are typically blue in color or translucent with blue or black lettering.

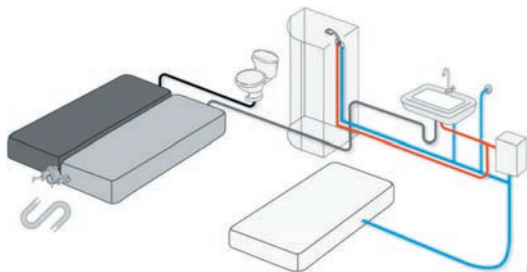

HEATED FRESH WATER LINES

Fresh water lines located beneath the slideout floor are typically heated to prevent freezing (i.e. refrigerator water supply). The water lines are routed in the heated water bay and inside the heated living area as much as possible.

Heated fresh water lines are typically used on floorplans with bath fixtures or a refrigerator containing an ice maker or water dispenser located in a slideout. Heated water lines are used to connect the plumbing from the basement area to the refrigerator where the water lines are exposed under the slideout. The 12 volt power to the heated water line is usually fused in the cord compartment fuse panel in diesel coaches and on the firewall fuse panel on gas coaches.



Some coaches may be equipped with a Manabloc water distribution manifold that allows water to be shutoff to individual water lines. For more information about the Manabloc, refer to Newgle.

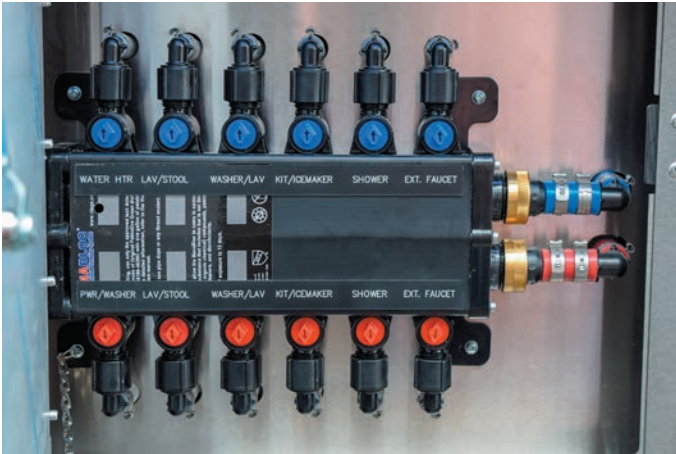

Some coaches may incorporate inline water valves on some water lines which may include the water spigot to the generator area or other non-heated compartment bays, ice maker water lines, and/or inline water filters. The valve(s) could be located various places depending on the coach year, model, and floorplan (i.e. under the kitchen sink, under the dinette booth, in the false pantry floor bottom, under the couch, or in the basement).

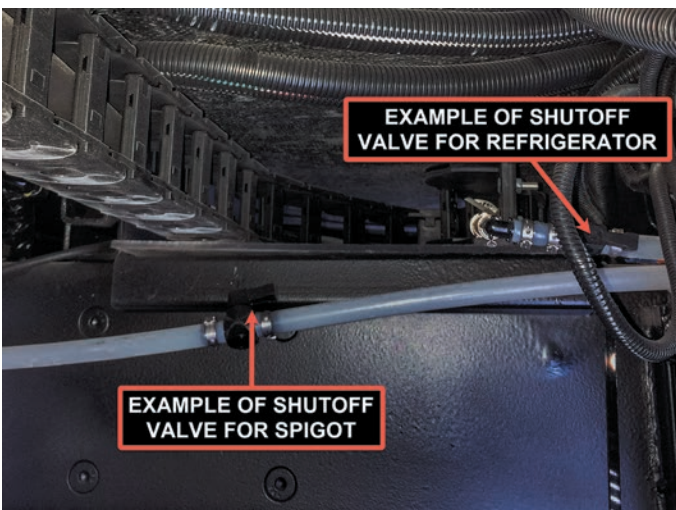

FRESH WATER LINES TO THE KITCHEN

The hot and cold plumbing lines connecting slideout-installed components, such as the kitchen sink and other optional equipment utilizing the coach water supply, are typically hard-plumbed within the slideout.



To ensure flexibility, a braided hose connects the rigid plumbing from within the slideout to the rest of the plumbing in the coach. This hose easily moves with the slideout as it extends and retracts. The plumbing lines are normally tied to the flexible drain pipe and extend and retract smoothly as the slideout travels.

Hot and Cold Low Point Drains

Low point drains are normally located in the water compartment and are marked “Low Point Drains.” Some valves are mounted in the water control panel and others are placed close to the water compartment and marked with a sticker nearby. Typically the coach has one hot water low point drain and one cold water low point drain, which are used to empty the water lines. Open the valves to relieve water pressure and drain the water lines. Close the valves for normal operation of the pressurized water system.

LOW POINT DRAIN CONFIGURATION EXAMPLES

On coaches equipped with tank rinse low point drain(s), turning the tank rinse drain valve to the “open” position will remove pressure and drain the tank rinse line. When finished using the tank rinse, it is recommended to turn off the water supply to the tank rinse connection. Open the valve, and drain off the pressure in the line before disconnecting the water hose.

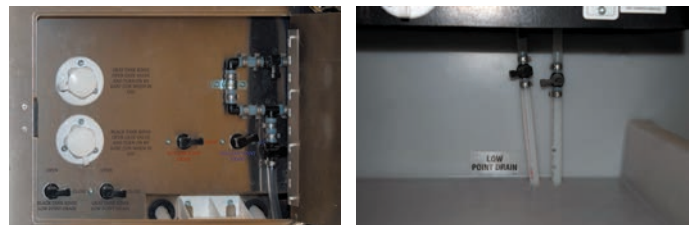

Preventing, Stopping, and Repairing Plumbing Leaks

Poor or improper winterization may cause leaks, and/or vibration and flexing during travel can cause pipes and fittings to work loose. Follow this checklist to prevent or repair any plumbing leaks:

- Check all of the plumbing connections for leaks on a yearly basis.
- If the water pump runs when all faucets are turned off, check for a leak.
- Be sure the drain valves are closed.
- Tighten any loose faucet connections with a wrench.
- Disconnect the leaking connections completely, and check for mineral deposits or foreign material on the sealing surfaces. Clean the surfaces thoroughly, and reinstall the fitting.

⚠ IMPORTANT

In the event of a water leak, immediately shut off the water pump and/or disconnect the coach from the pressurized water source. Open the low point drains in the water compartment. This will relieve pressure and allow time to locate the leak and/or a shutoff valve (if the coach is equipped).

⚠ IMPORTANT

Plumbing repairs should be performed by an authorized service center, followed by a pressure test.

Fresh Water Tank and Drain

This article provides a basic overview of the fresh water tank and drain. This tank is used to hold fresh potable water for use throughout the water system and is usually located on the floor of the water compartment; however, some coach floorplans may be equipped with a water tank located in another compartment. The fresh water tank is filled from the city water hook-up with a hose or hose reel.

⚠ WARNING

Potable water only. Sanitize, flush, and drain water tank before using. See owner's manual for instructions, care, and maintenance information. Failure to maintain tank can result in death or serious injury.

AD-04



The fresh water fill valve located in the service compartment near the water hook-up determines whether the city water is going through the water system or into the fresh water tank. The excess water will be vented from an overflow vent pipe onto the ground when the tank capacity has been reached. This pipe is installed in the fresh water tank to prevent tank rupture from overfilling.

Fresh water tank drains are located a few inches in front of or beside the fresh water tank and are connected to the fresh water tank with a 1/2" or 1" water line.

Whenever possible, drain the fresh water tank before traveling or only carry what you will need to get to your destination. Water in the tank will reduce the carrying capacity of the coach. All of the water should be drained from the fresh water system when the coach is not in use for more than one week to prevent stagnant water and reduce organic growth. To drain the fresh water tank, open the low point drain valve located near the fresh water tank.



FRESH WATER TANK DRAIN CONFIGURATION EXAMPLES



Fresh Water Valves

The article provides a basic overview for the Fresh Water Valves in a coach. The rotating “Fresh Water Valve” located in the water compartment is used to pressurize the fresh water system in your coach, as well as to fill the fresh water tank when the coach is connected to city water.

The Fresh Water Valve position determines whether the water supply fills the tank or pressurizes the fresh water system in the coach. Simply rotate the “Fresh Water Valve” to the appropriate position to perform the desired function.

IMPORTANT

If you leave this valve in the manual tank fill position, you may experience low water pressure while operating the water pump.

FRESH WATER VALVE EXAMPLES



Auto Fill

For coaches equipped with an Auto Fill function, the coach must be connected to a pressurized water source and have the Fresh Water Valve in the “Auto Fill” position. In addition to turning the valve, the coach must also have the Auto Fill function enabled within the tank monitoring system. This function is used to automatically fill the fresh water tank and shut off the water supply based on the tank levels. The system will turn on the Auto Fill valve when necessary and turn it off when the tank reaches capacity.

Both the Precision Circuit Digi-level and the KIB TMSC-100 systems control the electric auto fill valve via the monitor panel in an overhead panel and are fused in the 12 volt house fuse panel. The KIB TMSC-100 system’s circuit board is typically located in the shore cord compartment, and the Digi-Level does not use a separate circuit board.

The SilverLeaf system allows the Auto Fill feature to be activated via the touchscreen or the SPX-300 panel located in the water compartment. It is controlled by the TM102 module and uses the fuse panel and relay board typically located in the shore cord compartment. For more information about the coach’s tank monitoring system, refer to the sub-category within the Electronics section.

City Water Connection

Before connecting to your coach, use a potable water source to purge any remaining air and stale water in the hose. Then, connect the hose from the potable water source to your coach or the hose from your coach to the city water supply (if equipped with a hose reel). Turn on the supply valve at the water source, and open each of the faucets to remove any air pockets in the coach plumbing lines. Once the water flows freely, close the faucet(s).

FRESH WATER CONNECTION

AD-16

CITY WATER CONNECTION

AD-14

Water Pump

The water pump is used to pressurize the fresh water system when the unit is not connected to city water. The city water supply is under pressure, so the water pump is not necessary while you are connected to city water. Once the city water fill valve is not in the manual fill position, the water is supplied to the fresh water system components, including the hot water heater and faucets.

To disconnect from the city water supply, close the valve from the water supply. Release the pressure by rotating the fresh water valve to the tank fill position. Remove the hose from the city water supply, and store it in the water compartment. Once the pressure is relieved, rotate the fresh water valved to the appropriate operating position.

IMPORTANT

Use a water hose manufactured and labeled for potable water to ensure that the hose is drinking water-safe and will not alter the taste of the water.



Water Heaters

Keep your water warm for cooking, bathing, and cleaning in your coach.

Dometic Tank-Style Water Heater with Direct Spark Ignition Operation (Model: WH6GEA)

This article provides basic operation instructions for a Dometic tank-style water heater with direct spark ignition (Model: WH6GEA).

Operating The Electronic Control

- Place the control switch in the ON position.
 - If control switch light stays on longer than 15 seconds place the control switch in the OFF position, wait 5 minutes, and repeat Step 1.



GAS FUNCTION

WARNING

BURN HAZARD, FIRE, EXPLOSION, AND/OR CARBON MONOXIDE HAZARD. Keep the water heater area clear of combustible cleaning materials, gasoline, and other flammable vapors and liquids. Failure to obey this warning could result in death or serious injury.

NOTE FROM NEWMAR

Make sure the water heater is full of water and is not bypassed. Turn on the gas valve on the LP tank.

When the gas heating element switch is turned to the ON position, the Water Heater will make three attempts to light. If for any reason there is no ignition, the Water Heater will lockout and the red lockout lamp will illuminate. If the thermostat fails, the E.C.O. will also lockout the Water Heater and a reset will be required. Determine the reason for no control, correct it, and reset the gas control sequence by turning the switch to the OFF position then to the ON position.

ELECTRIC HEATING ELEMENT

NOTE FROM NEWMAR

Check for the proper voltage supply (120 Volts). Make sure the water heater is full of water and is not bypassed. Turn on the switch to the electric element. The water heater will control the temperature.

When the electric element switch is turned to the ON position, the relay will close and pass 110 VAC to the element. If the thermostat fails, the E.C.O. will open and lockout the system. To correct, check the thermostat to

assure good contact with the tank. Reset the control by turning the electric switch to the OFF position then to the ON position.

GAS/ELECTRIC FUNCTION

The unit can be run in both gas and electronic modes simultaneously for a quick recovery.

- If the gas fails to ignite, the gas mode will lockout, but the lockout lamp will not illuminate since the electric mode is still operational.

Should you notice slow recovery, indicating the gas is not working, turn the electronic control switch to the OFF position. The indicator lamp will illuminate signaling a lockout has occurred on the gas side.

Correct the problem and turn the switches to the ON position.

Maintenance and Care

WARNING

CARBON MONOXIDE POISONING HAZARD. Gas flames consume oxygen, which must be replaced to assure proper combustion. Provide fresh air during testing, service, and maintenance of this appliance. Failure to obey this warning can result in death or serious injury.

WARNING

FIRE OR EXPLOSION HAZARD. Failure to obey these warnings could result in death or serious injury:

- When performing any maintenance or care, shut off the gas supply at the L.P. container before disconnecting a gas line.
- Keep the control compartment clean and free of gasoline, combustible material and any flammable liquids and vapors.

Have the gas pressure tested periodically. The pressure should be set at 11 in. (27.94 cm) of water column with three appliances running.

Drain the Water Heater at regular intervals (at least one time during the year).

Drain the Water Heater before storing the RV for the winter or when the possibility of freezing exists.

Keep the vent and combustion air grill clear of any obstructions.

Periodically check the main burner flame.

PERFORMING PREVENTATIVE MAINTENANCE

Spiders, mud wasps, and other insects can build nests in the burner tube. This will cause poor combustion, delayed control, or flame outside of the combustion tube and the burner assembly.

Listen for a change in burner sounds or look for changes in flame appearance from a hard blue flame to a soft lazy flame or one that is very yellow. These are indications of an obstruction in the burner tube or the burner assembly.

Inspect and clean the burner tube on a regular basis. Run a flexible wire brush down the burner tube to remove obstructions or clean the burner tube and the burner assembly.

RE-ESTABLISHING THE THERMAL EXPANSION AIR POCKET

1. Let the water cool or let the water run until it is cool.
2. Turn off the main water supply (the pump or water hook up source).

CAUTION

SCALDING HAZARD. Turn off the water heater before opening the P/T relief valve to establish air space. Storage water must be cool. Failure to obey this caution could result in minor or moderate injury.

3. Open the hot water faucet closest to the Water Heater.
4. Pull the handle of the P/T relief valve straight out and allow water to flow until it stops.
5. Allow the P/T relief valve to snap shut.
6. Close the faucet.
7. Turn on the water supply.
8. Turn on the Water Heater and test.
 - At least once a year, manually operate the P/T relief valve.
9. When the P/T relief valve discharges again, repeat Steps 1–8.

TO FLUSH WITH THE P/T RELIEF VALVE:

1. Lift the P/T relief valve handle.
2. Apply air pressure through the P/T relief valve.

FLUSHING THE TANK

Use this procedure for general flushing of the water heater tank.

1. Turn off the main water supply (the pump or water hook up source).
2. Remove the drain plug to drain the water from the tank.
 - If the water drains sporadically or trickles out of the drain hole, open the P/T relief valve then use a small gauge wire or coat hanger to remove any obstructions from the drain hole.

- With the tank drained, approximately two quarts of water remain at the bottom of the tank. This water contains most of the corrosive particles. To remove these particles, use an “RV Water Heater Flushing Tool.” The wand of this flushing tool allows the water jet to clean at different angles inside of the tank. Cleaning at different angles inside of the tank will suspend and flush the corrosive particles out of the drain coupling.
3. Continue flushing the tank until the water being flushed from the drain coupling is draining as clear water.
 4. Replace the drain plug.

SERVICING THE P/T RELIEF VALVE

WARNING

EXPLOSION OR SCALDING HAZARD. Failure to obey the following warnings could result in death or serious injury.

- Do not tamper with the P/T relief valve.
- Do not place a valve, plug or reducing coupling on the outer part of the P/T relief valve.
 - The P/T relief valve is a safety component and must not be removed for any reason other than replacement.
 - Tampering with the P/T relief valve will void the warranty.

The P/T relief valve is not serviceable. If the P/T relief valve is found to be faulty, replace the valve.

This Water Heater is equipped with a P/T relief valve that complies with the standard for Relief Valves and Automatic Gas Shutoff Devices for Hot Water Systems, ANSI 221.22.

If a discharge line is used, do not use a reducing coupling or other restriction smaller than the outlet of the P/T relief valve. Allow both the valve and the line to completely drain.

A P/T relief valve dripping while the Water Heater is running does not mean it is defective. During normal expansion of water, as it is heated in the closed water system of an RV, may cause the P/T relief valve to drip. The Dometic water heater tank is designed with an internal air gap at the top of the tank to reduce the possibility of dripping. Over time, the expanding water will absorb this air and it must be restored. Due to variations in water quality, the P/T relief valve may have a shorter life and may need replacement within the Water Heater warranty period. If corrosion is detected, it will not be covered under warranty.

Source(s): Dometic Heating Water Heaters Installation and Operation Manual (10/19)

Product(s): Dometic 6-Gallon Tank-Style Water Heat with Direct Spark Ignition (Model: WH6GEA, Newmar Part Number: 156458)

Truma AquaGo® Comfort Plus LP Gas Instant Water Heater Operation (Model: DLE60CP)

This article provides basic operation instructions for a Truma AquaGo® Comfort Plus LP Gas Instant Water Heater (Model: DLE60CP).

How It Works

The appliance was developed exclusively for use in recreational vehicles (RVs). The appliance is connected between the vehicle's fresh water supply and its hot water plumbing system. It is powered by propane and a 12 V power supply. The ventilation grille on the access door allows combustion air to flow into the appliance and exhaust gas to flow out. When the appliance is switched on, the water will be heated on demand:



- A volume-flow sensor in the appliance detects when the hot water faucet has been opened and the volume flow is greater than approximately 0.4 gallons/min (1.5 liter/min). The burner then starts automatically.
- The burner control continuously adjusts the heater output based on volume flow and inlet water temperature, so that the temperature at the hot water outlet is approximately 120 °F (49 °C). A temperature stabilizer is also installed in the appliance to minimize fluctuations of the outlet temperature.
- After some time the maximum temperature at the faucet or in the shower is reached. The length of time will depend on the model (AquaGo basic, AquaGo Comfort and AquaGo Comfort plus) and variations in the water plumbing (length of pipes, insulation, circulation line, etc.). Like in a home shower, a comfortable water temperature at the shower head is reached by mixing in cold water.
- When the volume flow is less than approximately 0.4 gallons/min (1.5 liter/min) and the faucet is closed, the burner is automatically switched off.

The AquaGo Comfort and AquaGo Comfort plus models are equipped with a circulation pump. The circulation pump as well as the burner are switched on automatically by the control unit in order to keep the water temperature above 102 °F (39 °C) in "COMFORT" mode and 41 °F (5 °C) in "ECO" mode.

⚠ NOTICE

Risk of damage in frost conditions.

Pressure Relief Valve

⚠ WARNING

Scalding injury from hot water and/or tampering with the pressure relief valve! Never actuate the pressure relief valve as long as the appliance is still hot. Do not place a plug or reducing coupling on the outlet part of the valve.

- The pressure relief valve is a safety component and must not be removed for any reason other than replacement.
- The pressure relief valve is not serviceable; if defective, it must be replaced.
- It must be replaced by a Truma pressure relief valve rated for 100 psi (6.9 bar) that is CSA-certified and registered.
- It must be replaced by a Truma certified service technician.
- Tampering with the pressure relief valve will void the warranty.

The appliance is equipped with a pressure relief valve that complies with the standard for Relief Valves for Hot Water Supply Systems, ANSI Z21.22

Access Door

OPENING THE ACCESS DOOR

1. Turn the turn lock counterclockwise into the vertical position.

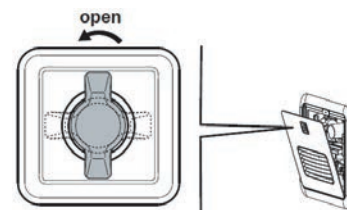

- The access door can be opened in two different positions:
 - Position 1 is the maximum opening width for switching the appliance on or off.
 - Position 2 is the starting position for removing the access door.

⚠ NOTICE

Damage to the hinge! Do not try to remove the access door in Position 1. Position 1 is the maximum opening width of the access door. Only remove the access door in Position 2.

2. Open the access door to Position 1.

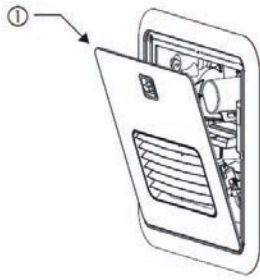

REMOVING THE ACCESS DOOR

1. Open the access door to Position 2.
2. Move the access door upwards to remove it.

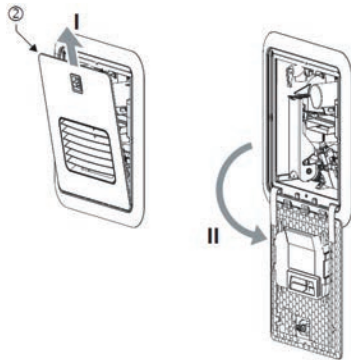

CLOSING THE ACCESS DOOR

NOTICE

Damage to the access door and the RV if the access door is not closed properly! Make sure that the access door is flush with the cover plate when closed.

1. If removed, insert the access door into the cover plate.
2. Make sure that the webbing is not pinched between the access door and the cover plate.
3. Press the access door against the cover plate.
4. Turn the turn lock clockwise into the horizontal position.

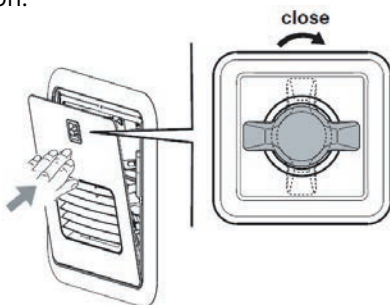

WARNING

Danger of over-temperature and toxic exhaust gases! Use with LP gas (propane) only. Butane or any mixtures containing more than 10 % butane must not be used. Keep the air inlet and exhaust gas outlet free of obstructions. Do not lean any objects against the water heater's access door or place any foreign objects within 2 feet (61 cm) of the access door.

WARNING

Danger of combustion, personal injury and damage to RV! Keep the area around the appliance free from combustible materials, gasoline, and other flammable vapors or liquids. Switch the gas supply and the appliance off: if anything seems to be out of the ordinary, if you smell gas, if you move the RV, before entering a gas station, before entering a tunnel.

Inspections Before Each Use

Check the appliance for the following points before each use. In case of damage, contact an authorized Truma service provider and do not operate the appliance.

1. Check for visible damage, e.g., on the cover plate or access door.
2. Provide adequate quantities of propane gas and fresh water.
3. Switch ON and check 12 V power supply of your RV.
4. Check that the access door of the appliance is closed.
5. Keep the appliance free of foreign objects, e.g., leaves, animals, spiderwebs, and keep the area around free of snow and ice. The appliance will not function properly if the intake air or exhaust terminal is obstructed.

Operating Procedures

NOTICE

Risk of damage in frost conditions. In frost conditions, ambient temperatures below 39 °F (4 °C), there is a risk that water in pipes, faucets and appliances could freeze. This can cause considerable damage. Before you fill water into appliances and parts that transport water, you must heat the installation area sufficiently so that the water cannot freeze.

Proceed as follows to fill the appliance with water:

1. Close open bypass lines (if present). Insert the water inlet filter or heating cartridge – if removed. 2, 7, 9 – 11.
2. Turn on fresh water supply or switch on water pump.
3. Fill the plumbing system.
 - Open all water-release points, e.g., cold and hot water faucets, showers, toilets.
 - It is important that you bleed the water system before starting the appliance.
 - Once water flows, the plumbing system is vented. Close the water-release points.
4. Start the appliance as follows:
 - Make sure that the LP gas supply is turned on.
 - Switch on the 12 V power supply (RV).
 - Open the access door.
 - Switch on the appliance at the POWER switch.

5. AquaGo Comfort / AquaGo Comfort plus:
 - Select the desired operating mode.
 - Close the access door.

⚠ WARNING

Scalding injuries caused by hot water! Water temperatures over 127°F (52°C) can cause severe burns or scalding and in extreme cases even death. Before using the hot water faucet or using the shower, allow the hot water to run until the water temperature no longer increases. Test the temperature of the water before placing a child in the bath or shower. Do not leave a child or an infirm person in the bath unsupervised.

- There may be a variation between the temperature delivered from the appliance and the temperature at the faucet due to water conditions or the length of pipe from the appliance.
- The presence of a flow restrictor in the hot water line may limit the water flow.

How to use hot water:

- To obtain the desired water temperature at the faucet or in the shower, mix cold and hot water.
- Particularly when showering, wait until the water temperature has stabilized before entering or allowing other people or animals to enter the shower.

Switching On The Appliance

1. Open the access door.
2. To switch on the appliance, switch the POWER switch to one of the two “ON” positions.
 - Both ON positions on the POWER switch have the same function. Choose your preferred position.
 - When the green power ON LED 1 is lit, the appliance is switched on.
 - If the red error code LED 2 is lit / flashes, there is a fault or warning.

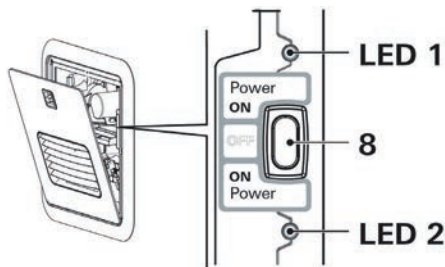

AQUAGO COMFORT / AQUAGO COMFORT PLUS

- The appliance is now ready for using the control panel inside your vehicle.

Operating Modes (Control Panel)

AQUAGO COMFORT / AQUAGO COMFORT PLUS

A control panel to select the operating mode.

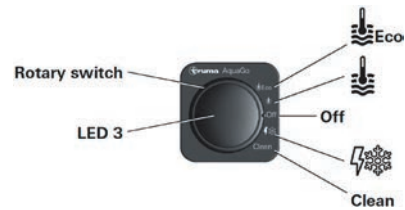

With the rotary switch you can choose between the following operating modes:

Symbol / Operating Mode	Description
ECO	The appliance is now running in energy-saving mode. <ul style="list-style-type: none"> • Water temperature at the outlet is approximately 120 °F (49 °C). • Prevention of freezing by using propane gas. The temperature in the appliance is automatically kept above 41 °F (5 °C). • During operation, the yellow status LED 3 is lit.
COMFORT	The appliance is now running in a mode that provides rapid availability of hot water. <ul style="list-style-type: none"> • Water temperature at the outlet is approximately 120 °F (49 °C). • Stand-by heat. The temperature in the appliance is automatically kept above 102 °F (39 °C). • During operation, the yellow status LED 3 is lit.
OFF	Stand-by. The appliance is not running in any operating mode. <ul style="list-style-type: none"> • The yellow status LED 3 is off. To switch off the POWER and gas supply, refer to “Switching OFF the appliance”.
ANTIFREEZE	Prevention of freezing using 12 VDC electricity: <ul style="list-style-type: none"> • Operating mode with installed electric antifreeze kit (available as an accessory) and appliance switched on. The temperature in the appliance is automatically kept above 41 °F (5 °C). • During operation, the yellow status LED 3 is lit.
CLEAN	Decalcification. Only AquaGo Comfort / AquaGo Comfort plus. See “Decalcification”. <ul style="list-style-type: none"> • For safety reasons, after 30 seconds the decalcification process cannot be stopped until the system has been rinsed in accordance with the instructions. See “Interrupting decalcification”.

DESCRIPTION OF THE YELLOW STATUS LED 3

Signal	Meaning
LED 3 is lit	Appliance is switched ON
LED 3 is off	Appliance is switched OFF.
Every 7 s, LED 3 is interrupted for 1 s	The appliance must be decalcified
LED 3 flashes slowly 1 s on, 1 s off	Decalcification mode has been activated
LED 3 flashes quickly	Before you use the water system you must rinse it.
LED 3 flashes 2 x briefly after a break.	There is a fault in the appliance. The exact fault diagnosis must be determined via error LED 2. Risk of freezing if the temperature in the appliance is below 37.4 °F (3 °C).

Switching Off The Appliance

1. AquaGo Comfort / AquaGo Comfort Plus
 - Set the control panel to “Off”.
2. Open the access door.
3. Switch off the appliance at the POWER switch.
 - The green Power-ON LED 1 extinguishes.
4. Close the access door.
5. If the appliance is not needed, turn off the gas supply to the appliance.
 - If you intend to put the RV into storage or turn off the appliance during freezing temperatures.

Operation In Frost Conditions

(Ambient temperatures below 39 °F (4 °C))

NOTICE

Risk of damage in frost conditions. In frost conditions, ambient temperatures below 39 °F (4 °C), there is a risk that water in pipes, faucets and appliances could freeze. This can cause considerable damage. If the appliance is not to be used in frost conditions, you must winterize the appliance. Winter operation will not protect the RV’s entire water system. Water lines, faucets, water tanks and the external water valves and the vehicle must be heated separately. The RV must be designed for winter use/freezing conditions. The water pipes in the RV must be ice-free to operate the AquaGo Comfort / AquaGo Comfort plus in winter. Otherwise, there is no water flow and the appliance does not start.

ONLY AQUAGO COMFORT / AQUAGO COMFORT PLUS

When the vehicle is standing, to -4 °F (-20 °C):

- The appliance has a built-in thermostat that will start the burner and the circulation pump whenever the temperature in the appliance falls below 41 °F (+5 °C). The burner will automatically shut off when it senses a temperature above 111 °F (44 °C).

NOTICE

For the appliance to operate properly, you must ensure a constant supply of power (12 V), propane gas, sufficient water in the system. You must leave the appliance powered “ON”. The operating mode must be “ECO” or “COMFORT”. The water system must be bled so that the circulation pump works.

NOTICE

If the vehicle is standing and ambient temperatures are below -4 °F (-20 °C), the appliance must not be operated and must be winterized.

While driving (or if there is no gas supply), to -4 °F (-20 °C)

NOTICE

Gas must not be used for heating while the vehicle is in motion. Ask your dealer / vehicle manufacturer about options for heating your RV while driving.

An electric antifreeze kit is available as an accessory (ask your dealer). With this kit, the appliance can be kept frost-free while you are driving or if there is no gas supply (to ambient temperatures of -4 °F (-20 °C)). The electric antifreeze kit includes detailed instructions.

NOTICE

While the vehicle is in motion and at ambient temperatures below -4 °F (-20 °C) the appliance must not be operated and must be winterized.

Winterizing

NOTICE

Severe damage to the water system components and the appliance! Any damage caused by freezing or an unsuitable winterizing fluid will not be covered by warranty. Follow the recommendations below if the appliance will be stored under freezing conditions or for an extended period of time. Winterize the appliance at the start of the winter season or before traveling to a location where freezing conditions are likely.

If your RV is equipped with a bypass around the appliance, separate the appliance from the water system with the bypass.

WINTERIZING THE APPLIANCE

To winterize the appliance, you must drain all water from the appliance. To do this we advise the following steps:

- Remove the water inlet filter or heating cartridge.
- Let water completely drain from the appliance. This can take several minutes.
- Do not insert the water inlet filter or heating cartridge into the appliance during winter – if the appliance is not used.

CAUTION

Danger of crushing/pinching of fingers when the Easy Drain Lever is closed! Never put fingers between the Easy Drain Lever and latch.

- Close the Easy Drain Lever and the access door.

Once the water has been drained, the appliance is protected against freezing conditions.

▲ IMPORTANT NOTE FROM NEWMAR

On coaches equipped with a Truma AquaGo water heater mounted above the floor line of the coach, open the low point drain located in the hot water recirculation loop between the shower loop and the water heater. The exact location will vary, but the low point drain is typically located in the basement area at or near the lowest point in the loop and may be marked with a low point drain label.

WINTERIZING THE RV WITH A WINTERIZING FLUID

- Winterizing the RV with a winterizing fluid is only possible with an installed bypass kit (not in scope of delivery)
- Refer to “Connection diagrams” for all letters referred to in the following description.

WINTERIZING AQUAGO COMFORT PLUS

1. Close valves A, B and E.
2. Make sure that valve D remains in the closed position.

3. Open valve C.
4. Drain the appliance.
5. Flush the RV’s water system with a suitable winterizing fluid according to the supplier’s or RV manufacturer’s guidelines.
6. Close all faucets (if open).
7. Open valve D.
8. Wait until winterizing fluid has drained. Collect escaping fluid in a suitable vessel.
9. Close valve D.

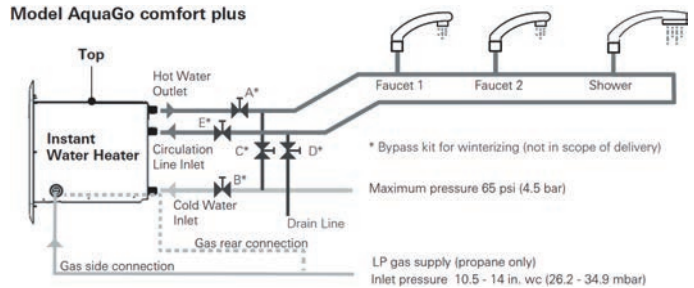

Source(s): Installation and Operating Instructions Truma AquaGo Basic / Comfort / Comfort Plus

Product(s): Truma AquaGo Comfort Plus Water Heater (Model: DLE60CP, Newmar Part Number: 144933)

Water Heater 2-Valve Bypass System Overview

This article provides a brief overview of a Water Heater 2-Valve Bypass System. The 2-valve bypass system is located near the water heater.

Using the bypass valve(s) while winterizing your coach will prevent anti-freeze from reaching the water heater. Draining the water heater during winterizing is required. On some coaches, this consists of two valves: one at the inlet and one at the outlet of the water heater.

By closing the inlet and outlet valves, it opens the bypass hose between the inlet and outlet lines allowing the hot water lines to be blown out and RV winterization antifreeze to flow through, bypassing the water heater.

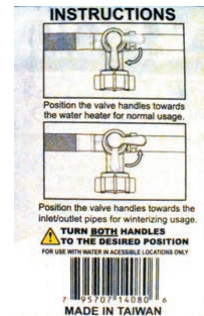

Water Pumps and Controllers

Water Pump Operation and Basic Troubleshooting

This article provides basic operating instructions and troubleshooting tips for a water pump.

The water pump is self-priming and totally automatic, operating on demand whenever water is required. When not connected to city water, the coach’s water pump is used to pump and pressurize water from the fresh tank for distribution through the hot and cold water lines.

When the water pump switch is turned on, the water pump builds pressure in the system and will shut off as soon as the system is correctly pressurized. When a faucet is opened, the pump will turn on and operate as necessary to maintain the preset pressure in the system.

Water pump operation is not necessary while the coach is connected to city water, since the potable water is already pressurized.

When using water at a low flow rate (GPM), the pump may pressurize the system and short cycle, meaning the pump shuts on and off quickly. In many cases, the pump will stop short cycling if the flow rate of the water is increased.

Operation

1. Fill or partially fill the fresh water supply tank.
2. Open the kitchen and bathroom faucets.
3. Turn the water pump switch on, and allow the water to fill the water line and the hot water heater. The switch to this pump may be located in the exterior water compartment, in the kitchen, or in the bathroom.
4. Close each faucet after it delivers a steady stream of water (close the cold water first). Leave the hot water faucets on until they also deliver a steady stream of water. This will ensure that the water heater is filled with water.
5. The water pump should stop running once all faucets are closed.
6. The pump is now ready for automatic operation. The pump will run when a faucet is opened and stop when a faucet is closed and the correct pressure has been reached.

CAUTION

Never allow the pump to run for long periods of time without water in the supply tank, as pump damage or blown fuses may result.



Faucets and Fixtures

Your installed bathroom and kitchen faucets and fixtures are available in many styles, finishes, and configurations, often complementing the other fixtures in your coach.

With proper maintenance, the faucets in the coach should provide years of trouble-free usage. The faucets and fixtures can be cleaned by wiping with a soft, damp cloth. Washing with warm water will remove dry water spots. Turn off the water and drain the pressure before attempting repair or replacement of the faucet.



Filters

Water Filter Care and Maintenance

This article provides basic care and maintenance recommendations for water filters. Your coach may be equipped with a fresh water filtration system. This system uses extruded carbon filter cartridges to remove sediment and certain impurities from the incoming water supply. The filter assembly is located in the basement water compartment. Select coach models may also have additional filters installed for drinking water.

When To Replace Your Filters

Most water filter manufacturers recommend that you replace your water filters every six months. These guidelines are based more on average household size and average consumption rates rather than your specific coach. The frequency of filter changes depends upon your water usage and the quality of water you are using. As you travel and hook up to different water sources some may contain more sediment, metals, sulfur and other impurities which affect the filter life, the taste and

Care and Maintenance

All of the water should be drained from the fresh water system when the unit is not in use for more than one week.

Troubleshooting

If water doesn't flow when a faucet is turned on while using the demand system, use the following troubleshooting tips.

If the pump is running, but there is no water:

- Fill the tank.
- Clear the water line to the pump or the pump inlet filter.
- Rotate the city water / tank fill valve to the correct position.

If the pump isn't running:

- Check the pump switch.
- Check the 12 Volt fuses.
- Check the electrical connections.
- Check the battery.

IMPORTANT

Avoid using "S.O.S." type cleaning pads or other abrasive cleaners because they may scratch the surface. Do not use cleaners that contain harsh or abrasive chemicals. Alcohol or similar solvents should never be used.

smell of your water. Other factors are how often it is used and stored and how long water is able to sit in the holding tank and become warm and stagnate.

Change the filter at least every six months and at any time you notice decreased water flow or notice unpleasant taste, odor, or algae after flushing and sanitizing the water system. Water filters and fresh water system maintenance are the customer's responsibility in order to ensure safe potable water.

Flow-Pur Whole House Water Filters

This article provides basic instructions for replacing a Flow-Pur Whole House Water Filter. Replacement filter cartridges are available through the Newmar parts department. For parts inquiries, refer to the NewPar (formerly ComNet) parts catalog or contact the parts department at 1-800-731-8300 (option #1).

1. To replace the filter cartridge, turn off the water supply to the coach at the city water connection, or turn off the water pump if using potable water.
2. Drain the water pressure off the system by opening a faucet or low point drain, and press the red button on top of the filter housing.
3. Unscrew the filter canister by rotating to loosen and remove it (the top housing has male right hand threads, and the canister portion has female threads).
4. Insert the new filter cartridge, positioning it so the opening in the bottom of the filter is placed on the molded ring at the bottom of the canister.



⚠ CAUTION

When replacing the filter, make sure the rubber O-Ring seal is properly positioned in its groove in the cartridge housing. An improperly positioned or missing seal will cause leakage around the perimeter of the filter housing.

5. Reattach the canister to the filter housing by rotating the canister until it tight. Do not over tighten the canister when attaching it back to the housing.

⚠ IMPORTANT

Do not allow water to freeze in the water filter canister. Freezing will crack and permanently damage the filter housing and associated plumbing. Always remove the filter cartridge prior to winterization.



Power Washers, Sprayers, and Exterior Showers

Exterior Shower Overview

An exterior shower located in the water compartment on the driver side may be an optional feature on your coach and can be used to rinse off sand or grass, muddy shoes, or bathe a pet outside of the coach. The exterior shower may also be used to wash your hands or rinse off the sewer hose after dumping the waste water tanks.

The faucet operates just as it would in the kitchen or bathroom. When finished using the exterior shower, shut off both the hot and cold valves. Do not simply shut off the valve on the shower head itself, as it may cause hot and cold water to mix at the exterior shower and could allow drastic changes in water temperature throughout the coach.



Waste Water System

There are two separate waste systems: the gray tank system and the black tank system. Each tank has its own control valve, and both tanks drain through the sewer drain hose.



Sinks, Tubs, and Showers

This article provides an overview and care and maintenance recommendations for sinks, tubs, and showers. The sink and shower are the beginning of the waste water system. The basic purpose is to contain the used water so it can be drained via the attached waste water drain line to the holding tank.

Care and Maintenance

The maintenance requirements for sinks and the shower are on an as-needed basis. Occasionally, the attached drain and trap may need to be cleaned of soap scum and hair to maintain efficient drainage. The basins and shower walls can be cleaned to maintain the original luster. Clean the entire surface, including the exterior, of the lavatory and kitchen sinks and shower with mild soap and warm water. Wipe the entire surface completely dry with a clean, soft cloth.

IMPORTANT

Avoid using “S.O.S.” type cleaning pads or other abrasive cleaners because they may scratch the surface. Do not use cleaners that contain harsh or abrasive chemicals. Alcohol or similar solvents should never be used.

Follow these tips to maintain the shower(s) in the coach:

1. Make sure the shower doors are closed and latched or locked prior to travel.
2. Check for leaks in the shower seals. Reseal them as needed.
3. Using a mild detergent and a soft cloth, wipe down the shower walls and glass enclosures after each use to avoid soap scum and hard water deposits.
4. When winterizing the coach, clean up any remaining antifreeze in the shower, as it may cause staining.

P-Traps and Waterless Traps

This article provides an overview and care and maintenance recommendations for traditional and waterless p-traps.

P-Traps

The sinks and shower drain have a water trap to prevent holding tank odors from entering the coach. These traps must have water in them in order to trap the odors. While traveling, the water may leave the P-Trap. While stored, the water may evaporate, allowing an odor to enter the coach. If this occurs, run water from the faucet into the drain, allowing water to fill the trap.

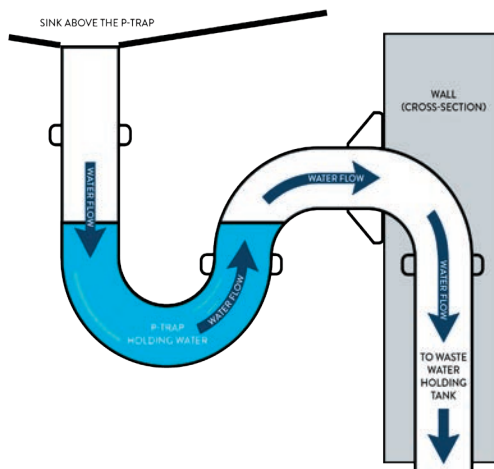

Waste Water Drain Lines

The drain lines are plumbed from the sinks, showers, and toilets are sloped to drain waste water to the grey or black tank. However, if the coach is equipped with a lift pump, refer to the “Lift Pump” article. If the coach is equipped with macerator toilet(s), refer to the toilet article(s).

The drain lines connecting slideout-installed components, such as the kitchen sink and other optional equipment utilizing the coach water supply, are typically hard-plumbed within the slideout. The hard plumbing from the kitchen slideout connects to the hard plumbing from the tank using a braided drain line to ensure flexibility as the slideout extends and retracts. The fresh water plumbing lines are normally tied to the flexible drain pipe and extend and retract smoothly as the slideout travels.



Waterless Traps

Some coach models with a rear shower may have waterless traps in lieu of conventional P-traps. Waterless traps are designed to allow water to drain and to prevent odor from entering the coach without the height requirements of the conventional p-trap. Pressure builds and the self-sealing valve opens as water drains from a fixture. The valve closes to form a tight seal after the water has completely drained from the sink or shower. No routine or seasonal maintenance is required for the waterless trap.

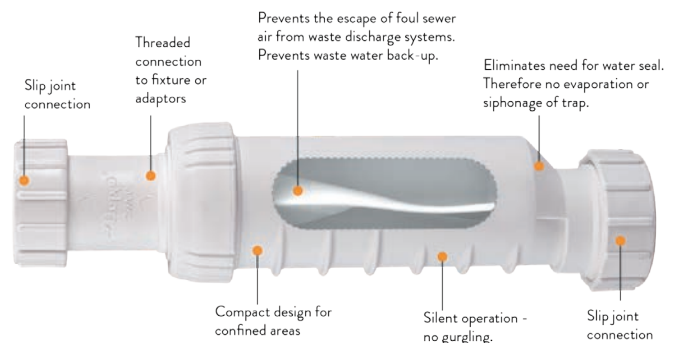



NOTICE
 Remove the waterless trap before using mechanical drain-cleaning devices. Waterless trap can be damaged.
 AD-123

Foreign objects, such as hair, in the trap may allow odor to enter the coach and impede or slow water drainage and require occasional cleaning. When removing the waterless trap for cleaning, the ridges must be down and the direction of water flow must be correct when re-installed.

IMPORTANT
 If standing water occurs in your shower, do not attempt to unplug or open the drain with a coat hanger or a sewer snake. Before taking your coach to a service center, try leveling your coach so that the rear is raised slightly higher than the front. This may correct the condition and prevent drain-cleaning or a service repair. If this does not correct the issue, Newmar recommends taking your coach to a service center for drain-cleaning or repair.

SFA Saniflo Lift Station Pump Operation (Model: Sanivite)

This article provides basic operation instructions for a SFA Saniflo Lift Station Pump (Model: Sanivite).

Overview

Certain floorplans may use a lift pump in locations where plumbing drains are too low or too far away for gravity drains to effectively reach the waste water holding tanks. The design is a small collection tank with an inlet from the sink or shower with a submersible pump to push the water out of the discharge to the holding tank.



Note: Lift pumps operate on 120 volt power. The coach must be plugged into shore power or using the generator, or, when dry camping, the batteries must be charged and the inverter must be operational. Some coaches may have a separate small inverter just to operate the lift pump; however, most will share the inverter with other inverted circuits.

Note: On floorplans with lift pumps, follow proper winterization instructions to prevent the system from freezing.

Operation

After storage and/or winterization, run the water from the bathroom or from the kitchen appliance connected to the pump. Check to make sure connections are water tight and that the pump starts and stops correctly.

The pump starts automatically as soon as the bath, the shower, or the sink begins to drain. It shuts down when the water has been drained.

Note: The pump may cycle on and off several times as it discharges the drain water.

*Source(s): SFA SaniVite Installation Instructions and Technical Data
 Product(s): SFA Saniflo Lift Station Pump (Model: 8-59925-00208-4, Newmar Part Number: 125332)*



Toilets

Toilet Overview, Care, and Maintenance

This article provides an overview of toilet operation and care and maintenance. “Go” in style and comfort, no matter where your travels may take you.

Waste Water Drain Lines

The drain lines are plumbed from the sinks, showers, and toilets are sloped to drain waste water to the grey or black tank.

Care and Maintenance

Before using the stool, treat the tank with water that is mixed with an odor-controlling chemical, which is readily available at any RV supply store. Mix as directed on the holding tank chemical package. After mixing and flushing the chemical mixture, the waste tank is ready for use. The stool should be cleaned regularly for maximum sanitation and operational efficiency.

IMPORTANT
 Be careful not to spill the chemical on your hands, clothing, or the carpet, as it may cause a permanent stain.

CAUTION
 Use only approved RV odor controlling chemicals in the holding tanks. Do not use chlorine or caustic chemicals like laundry bleach or drain-opening chemicals, as they will damage the seals in the toilet and dump valves. Products containing ammonia and petroleum may damage the ABS plastic holding tanks and seals.

When using your stool, it is wise to fill the bowl 3/4 full of water. This will help to wash the solids away from directly below the stool and to ensure complete dumping of the holding tank. After flushing, a small amount of water should remain in the bowl.

⚠ IMPORTANT

Before adding water, consult the toilet manufacturer's owner's manual for the specific procedure relating to your system.

⚠ NOTICE

To prevent holding tank odors from entering the living space, make sure a small amount of water remains in the toilet bowl.

⚠ NOTICE

Residual water trickle in ceramic bowls: Due to integrated rim of this toilet bowl, water may continue to slowly trickle into toilet bowl for up to 20 minutes after flushing. If water trickle continues after 30 minutes, replace the water valve.

⚠ WARNING

Do not flush diaper wipes, feminine hygiene products, or any other products that would not be easily liquefied. Also avoid using holding tank deodorant capsules, as they may cause damage to the macerator. Damage resulting from flushing any materials or objects other than organic waste and toilet paper are not warrantable repairs.

Dometic Standard Gravity-Discharge Toilets with Flush Pedal Operation (Models: 300, 310, and 320 Series)

This article provides basic operation instructions for a Dometic Standard Gravity-Discharge Toilet with Flush Pedal (Models: 300, 310, and 320 Series). Dometic 300, 310, and 320 series toilets are lightweight, residential-size toilets for installation directly above a holding tank.

Adding Water To The Toilet Bowl

To add water to the toilet, press the flush pedal part of the way down. Water flows into the bowl while the flush ball remains closed. If the flush ball moves, let up on the pedal slightly. Adding water to an empty bowl helps prevent holding tank odors from entering the living space. Adding water is recommended prior to flushing solids and toilet paper.

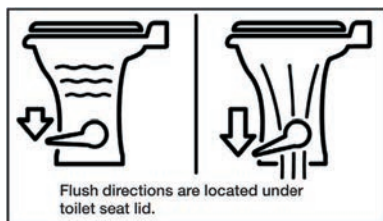

Flushing The Toilet

To flush, press the pedal down until it contacts the floor. Release the pedal after the complete flush.

- When flushing liquids, press the pedal for 1-2 seconds.
- When flushing solids, press the pedal until contents are rinsed from bowl. Flushing longer than necessary will cause holding tank to fill too quickly.

A small amount of water will collect in the bowl after a flush to create an airtight seal.

*Source(s): Dometic 310 and 320 Series Gravity-Flush Toilet Instruction Manual
Product(s): This source is associated with more than one product. Refer to Newgle for more information about the product(s) offered for your coach's model year.*

Dometic Standard Gravity-Discharge Toilets with Flush Handle or Wall Switch Operation (Models: 4300 and 4400 Series)

This article provides basic operation instructions for a Dometic Standard Gravity-Discharge Toilet with Flush Handle or Wall Switch (Models: 4300 and 4400 Series).

Dometic 4300 and 4400 series electric gravity-discharge toilets flush waste in to a holding tank or other effluent storage/disposal system. Operated by a wall-mounted flush switch or electronic flush handle, the toilet allows the user to add water to the bowl (before using or flushing) and to flush the toilet by pushing a button.

Adding Water To The Toilet Bowl

Raise the flush handle or press "Add Water" switch until desired water level is achieved. More water should be added when flushing solids.

⚠ CAUTION

Do not add too much water to the bowl, or the toilet may overflow.

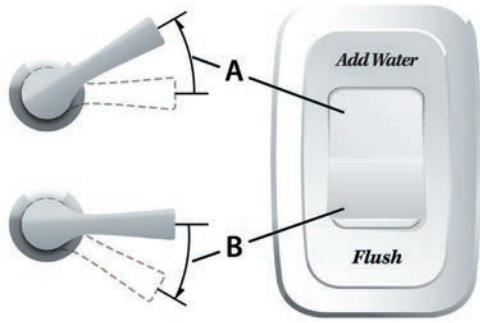

Manual Override Operation

In the event of a power failure and emergency flushing is required, or for cleaning purposes, the flush ball can be opened with the Manual Override feature.

1. Open the small round plastic cover on the back ledge of the toilet.
2. Insert a screwdriver or other thin blunt-end rod, and push down on Manual Override Lever to open the flush ball.
3. Perform the desired function.
4. The flush ball will close only when electric power is restored to the toilet.

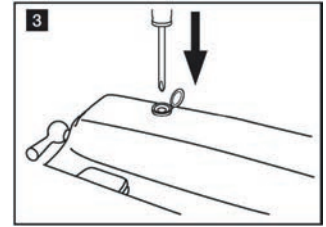

Flushing The Toilet

Press the handle or “Flush” switch, and then release when flush is complete.

Source(s): Dometic 4300 4400 Series Toilet Operation Manual

Product(s): This source is associated with more than one product. Refer to Newgle for more information about the product(s) offered for your coach's model year.

Dometic Macerator-Style Toilets with Flush Pedal Operation (Models: 7600 Series)

This article provides basic operation instructions for a Dometic Macerator-Style Toilet with Flush Pedal (Model: 7600 Series).

The Dometic MasterFlush 7600 series electric-flush toilet macerates waste and pumps it to a holding tank or other effluent storage or disposal system. Operated by a flush pedal, the toilet allows the user to add water to the bowl (before using or flushing) and to flush the toilet.

Adding Water To The Toilet Bowl

To add water to the toilet, press the flush pedal slightly. To avoid possible overflow, water flow will stop automatically if the pedal is pressed too long. More water is usually added only when flushing solids.

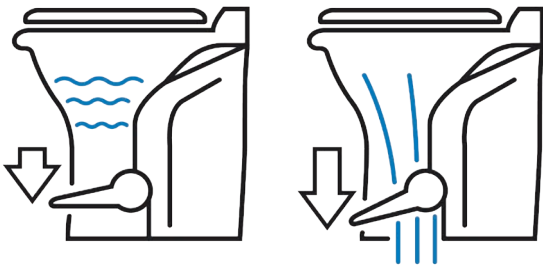

Flushing The Toilet

To flush, press the pedal down completely, then release it. This activates a powerful macerator pump that siphons water and waste from the toilet bowl, macerates and propels the effluent to the holding tank.

⚠ NOTICE

Residual water trickle in ceramic bowls: Due to integrated rim of this toilet bowl, water may continue to slowly trickle into toilet bowl for up to 20 minutes after flushing. If water trickle continues after 30 minutes, replace water valve.

Changing Flush Modes

MasterFlush 7600 series toilets offer two flush settings to help manage water consumption:

1. Normal Flush: Uses 0.83 gallons per flush and adds water to the bowl after every flush.
2. Dry Bowl Flush: Uses 0.21 gallons per flush and does not add water to bowl after flush.
3. To change from Normal to Dry Bowl flush setting, press “Flush” pedal for about 10 seconds. Flush mode has been changed to Dry Bowl setting. Change mode to Normal flush by following the same procedure.

Source(s): Dometic 7600 Series MasterFlush Toilet Instruction Manual

Product(s): This source is associated with more than one product. Refer to Newgle for more information about the product(s) offered for your coach's model year.

Waste Water Holding Tanks

This article provides a basic overview of the waste water holding tanks. There are two separate waste systems: the gray tank system and the black tank system. Each tank has its own control valve, and both tanks drain through the sewer drain hose.



The waste drainage system was designed to provide adequate and safe storage and/or disposal of waste materials. The drainage system uses plastic piping and fittings connected to the sinks, toilet, and holding tanks to provide for their drainage to an outside termination. All waste water tanks are vented through the roof and covered with a vent cap. The coach should be reasonably level for best operation of the system.



Some coaches not equipped with Oasis Hydronic Heating may have optional tank heating pads to reduce the risk of tank contents freezing.

Gray Water Holding Tank

The gray water holding tank is located in the underbelly of the coach, sometimes on top of the fresh water tank. It is primarily used for the drainage from the kitchen and bath sinks, shower, and the washing machine (if equipped).

⚠ CAUTION

The gray tank valve must be in the open position when operating the optional washing machine.

Black Water Holding Tank

The black water holding tank is generally for sewage waste from the stool. It is typically located between the frame rails in the water compartment directly beneath standard flushing toilets. Macerator-style toilets can be installed away from the black tank.

During normal use, tank buildup may occur on the inside of the tank. How quickly buildup occurs varies from user to user and is affected by many factors such as water hardness, the amount of solid waste, how easily the toilet paper breaks down, how often the tank is dumped, and how well the tank is flushed. When buildup occurs, it may impair the tank sensor's ability to read tank levels properly. Preventive tank maintenance is recommended.

Both tanks should be rinsed after dumping and treated with a waste tank additive to help break down and liquefy solid waste and help reduce odors. This chemical is readily available at any RV supply store.

⚠ IMPORTANT

Be careful not to spill the chemical on your hands, clothing, or the carpet as it may cause a permanent stain.

⚠ CAUTION

Use only approved RV odor-controlling chemicals in the holding tanks. Products containing ammonia and petroleum will damage the ABS plastic holding tanks and seals.

Waste Water Disposal

Both of the holding tanks terminate in a valve arrangement that permits draining each tank separately or together. The valves that open to release the water are called gate valves. The blade that closed the opening in the sewer drain pipes is connected to the T-handle to release the contents of the tank(s) when pulled.

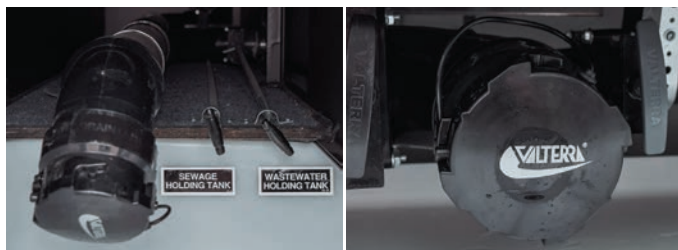

The sewer line must be securely capped during self-containment use to prevent leakage of waste material onto the ground or pavement.

Do not pull the holding tank gate valve open, or operate the electric dump valve switch (if equipped) when the protective cap is installed on the pipe. Always drain the tank into an acceptable sewer inlet or dump station.

⚠ WARNING

Holding tanks are an enclosed sewer system and must be drained into an approved dump station. Both black and gray water holding tanks must be drained and rinsed thoroughly on a regular basis in order to prevent the accumulation of harmful or toxic materials.

⚠ CAUTION

Keep drain valve closed to minimize the presence of sewer gases. Sewer gases can be present when RV is connected to campground sewage hookup. Can lead to illness or personal injury.

AD-120



⚠ WARNING

When routing the sewer or macerator hose, do not place on or near the Oasis, generator or engine exhaust pipes. Otherwise, damage may occur.

How To Drain The Waste Water Holding Tanks

The holding tanks should only be drained when they are at least three-fourths full, to provide sufficient water to allow the complete flushing of waste materials in the drain lines and hose. If the tanks are not three-fourths full, add enough water to allow for sufficient flushing. Whenever possible, drain the holding tanks prior to traveling. The carrying capacity of your unit will be reduced if water is left in the black or gray tanks.

To empty the waste water tanks, follow the procedure below, depending on the type of waste system your coach uses. It is recommended to drain the black water tank before the gray water tank. The holding tank valves may be operated via a tank gate valve (t-handle) or an electric dump valve switch (when equipped).

DRAINING THE WASTE WATER TANKS ON A COACH WITH A STANDARD GRAVITY DRAIN AND DUMP SYSTEM

1. Connect the adapter to the drain hose.
2. Unscrew the drain cap, and connect the hose with the adapter to the drain fitting. Support the hose as needed for optimal flow.
3. Open the gate valve all the way by pulling on the T-handle. The tank will start to drain as soon as the T-handle is pulled.
4. After you have drained the black water tank, immediately drain the gray water tank, allowing the water from the gray tank to wash the black water residue from the drain lines and hose.
5. When both of the tanks are empty, flush them with fresh water before you close the valves. Flush the gray tanks by pouring a couple of gallons of water into a sink drain. The drain outlet is engineered for quick release of the drain hose adapter.
6. Always close the gate valves and secure the end cap to prevent leakage while in transit.
7. Add a holding tank deodorant to help control the odor and break down the solid waste.

DRAINING THE WASTE WATER TANKS ON A COACH WITH A MACERATOR WASTE SYSTEM (SANI-CON)



The Sani-Con macerating waste system provides the following convenient features:

- Provides a sanitary method for discharging liquid waste from the RV by easily and quickly emptying waste-water from the RV's holding tanks, without relying on gravity.
 - The macerating system pumps liquid waste from holding tanks and does not rely on gravity.
 - The macerator is designed to process human waste and toilet tissue, making the Sani-Con ideal for black water, as well as gray water, discharges.
1. Make sure the black and gray water dump valves are closed.
 2. Point the hose nozzle upward, and remove the nozzle cap.

⚠ IMPORTANT

Select coaches equipped with a Sanicon macerator may have a valve to shut off the waste flow to the macerator drain hose. This valve can be shut off when using the larger gravity drain to prevent pressure and waste in the small hose when not in use or in the event that the small hose develops a leak. However, this valve must be open if you plan to use the macerator drain hose. You must open the valve prior to turning on the macerator.

3. Insert the nozzle into the sewer connection.
4. Open the gray water dump valve, and run the macerator pump for a few seconds to confirm that the system is operating correctly.

⚠ IMPORTANT

If there is a problem with the connection, or if the system is not functioning correctly, the macerator may need to be cleaned or serviced.

5. Shut the gray water dump valve, and turn off the pump switch once you have determined that there are no problems.
6. Open the black water dump valve, and turn on the macerator pump switch.
7. Monitor the tank as it empties. The pump will run louder when the tank is empty.
8. Turn off the pump switch once the tank is empty.
9. Flush the black tank, and operate the macerator while it is flushing.
10. Turn off the flush system, then turn off the macerator.
11. Close the black water dump valve.



12. Add tank chemicals and the amount of water recommended by the chemical manufacturer.
13. Drain the gray tank next to help flush out the macerator and sewer hose.
14. Open the gray water dump valve.
15. Turn on the pump switch.
16. Monitor the tank as it empties. The pump will run louder when the tank is empty.
17. Turn off the pump switch once the tank is empty.
18. Flush the gray tank, and operate the macerator while it is flushing (if equipped).
19. Turn off the flush system, then turn off the macerator.
20. Close the gray water dump valve.



21. Place the cap on the hose and store it.
22. Add tank chemicals and the amount of water recommended by the chemical manufacturer.

Camping With Sewer Hook-Up

When camping at parks with sewer hook-up, it is important to keep the black water holding tank gate valve closed at all times, except when dumping. The gray tank can be kept open while hooked to a sewer connection, but the black water tank must be kept closed. This is done so that an ample supply of liquid remains in the tank to provide a smooth flow through the gate and drain valve when dumping.

Sufficient liquid in the tank causes a swirling action that should take any accumulated solid wastes with it. Accumulation of solid wastes in the black water tank can be avoided by keeping the gate valve closed when connected to the sewer hook-up. If the valve is left open, solid wastes may accumulate in the tank. This may eventually result in costly repairs.

Holding Tank Rinse - No Fuss Flush

This article provides an overview of the holding tank rinse - no fuss flush. The coach may be equipped with a flushing system for the holding tank(s).

The basic tank rinse system consists of a water inlet, a vacuum breaker (normally located in a lavatory cabinet to provide placement of the vacuum breaker above the height of the tank), a fixed sprayer in the tank, and connecting water lines. When draining your sewer tank, attach a water hose to the sewer spray hookup. After the tank is drained, leave the gate valve open, and open the water valve to allow water to spray inside the sewage tank.

Allow the water to rinse the tank for a minimum of three to five minutes to ensure it is clean. This should flush the inside of the tank of any debris that may be left inside.

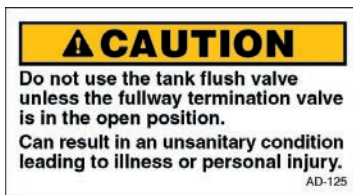
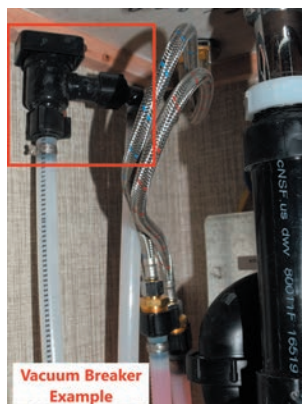

Next, disconnect the freshwater hose and close the gate valve. If there are any solids still left inside the tank, fill the sewage tank with approximately ten gallons of water and holding tank chemical through the stool. As you travel, the agitation of the water should help liquefy any solids left in the tank. You can dump the sewage tank again at your next destination.

Select coaches may also have a tank flush on the grey water tank. Follow the same flush procedure by leaving the grey tank gate valve open while flushing.



On coaches equipped with tank rinse low point drain(s), turning the tank rinse drain valve to the “open” position will remove pressure and drain the tank rinse line. When finished using the tank rinse, it is recommended to turn off the water supply to the tank rinse connection. Open the valve, and drain off the pressure in the line before disconnecting the water hose.

⚠ CAUTION

Do not use the same hose for the No Fuss Flush that is used for filling the fresh water tank. The gate valve to the sewage tank must be in the OPEN position while rinsing with the No Fuss Flush system.

⚠ IMPORTANT

Always drain the sewage tank prior to rinsing. Never rinse a sewage tank that is full. The sewage drain must be open while rinsing the sewage tank, and the drain hose must be positioned to drain into an approved sewage dump station. Failure to open the valve will cause the sewage tank to fill with water, and can cause damage to your plumbing and interior.

If you require additional instructions on gray/sewage tank valve operation, refer to the Waste Water Disposal article in Newgle.



SLIDEOUTS

This chapter provides information about electric flat floor, bedroom, kitchen, wardrobe, and full wall slideouts, as well as hydraulic slideouts.

IMPORTANT

Before operating any slideout, read and follow the warning labels and operation instructions posted in your coach.

Leveling and Full Wall Slideout Sequence of Operation

This article provides step-by-step instructions for leveling the coach and operating the slideouts.

IMPORTANT

In the past, Newmar has recommended leveling the coach prior to deploying the slideouts. As of 2015, Newmar makes the following recommendation for the extension and retracting of slideouts.

Motorhomes, like all vehicles, flex in travel. Flexing may be different due to terrain and the coach's fulcrums (resting on tires or jacks). As the coach flexes, this movement is more noticeable in the outside reveal on a wider slideout.

Extending The Slideouts and Leveling The Coach

1. Park the coach on a reasonably level campsite.
2. Leave the coach at ride-height with air in the air bags (if equipped with air suspension) or on normal suspension (coaches without air suspension).
3. Plug the coach into shore power (if available) or start the generator to increase the voltage for better slideout operation.
4. Look at the "reveal" or "gap" of the two vertical wall trims around the slideouts to make sure there is plenty of clearance so the trim will not rub when extending the slideout. If the gap looks good, then the slideout can be operated.
 - **Note:** Most often the gap will look best when sitting on the tires with the air suspension inflated (at ride-height), and not on the jacks.



IMPORTANT

In the unlikely occasion that the slideout trim has inadequate clearances, try leveling or repositioning the coach and rechecking the clearances before extending the slideout.

5. Verify that the path of the slideout is unobstructed and free from any surrounding objects, both inside and outside of the coach.
6. Once the appropriate conditions are met, follow the operating instructions posted in your coach to extend the slideouts (image for example only).

7. Dump the air suspension (if equipped). This step is included in the auto-leveling process for most coaches.
8. Deploy the leveling jacks.

Retracting The Jacks and Slideouts

1. Retract the leveling jacks.
2. Start the coach.
3. Allow the coach air suspension to fill and return to ride height (units without air suspension will return to normal suspension).
4. Turn the engine off.
5. For a full wall slideout, visually inspect the front vertical trim for adequate clearance. The spacing should look even from top to bottom (see image for reference).

IMPORTANT

In the unlikely occasion that the slideout trim has inadequate clearances, try leveling or repositioning the coach and rechecking the clearances before retracting the slideout.

6. Verify that the path of the slideout is unobstructed and free from any surrounding objects, both inside and outside of the coach. This includes any water or debris that may have collected on the slideout roof or the topper awning.

IMPORTANT

Debris left on the roof or topper may prevent the slideout from sealing properly when retracted, as well as prevent the mechanical lock arms from closing properly when the slideout is extended.

7. Retract the slideouts. Inspect all slideouts for complete retraction.
8. If the coach is equipped with manual lock arms, make sure to lock them.
9. Unplug the coach from shore power when you are ready to depart.

Electric Slideouts

Electric Slideout Operation

This article provides basic operation instructions for an electric slideout.

Electric Slideout Switches



ELECTRIC BEDROOM SLIDEOUTS

The operating switch for the bedroom slideout is usually located on the bedroom wall. If there is a full wall slideout on the driver side of the coach, the switch may be located on the wall that separates the bedroom from the living room.

ELECTRIC FLAT FLOOR SLIDEOUTS

Newmar pushed the RV industry forward by introducing the first flat floor slideouts. We continue to lead today with our patented flat floor slideout designs. The same insight and experience that helped us improve slideout functionality has also helped us improve slideout quality.

The operating switch for the flat floor slideout is usually located in the overhead cabinet above the driver or passenger chair or the overhead cabinet above the entrance door.

ELECTRIC FULL WALL SLIDEOUTS

Most electric full wall slideouts extend from the living area to the master bathroom in a Newmar coach.

ELECTRIC KITCHEN SLIDEOUTS

The operating switch for the kitchen slideout is usually located in the overhead cabinet above the driver or passenger chair or the overhead cabinet above the entrance door.

ELECTRIC WARDROBE SLIDEOUTS

The operating switch for the wardrobe slideout is usually located in the bedroom, on the wall beside the corresponding slideout.

Electric Slideout Operation

In order to operate a slideout with the required voltage levels, batteries should be fully charged, the generator should be powered on, or the coach should be connected to shore power. This maintains the voltage levels required to operate the slideouts.

⚠ IMPORTANT

Read entire slideout room instructions posted in your coach before extending or retracting the slideout.

- On diesel coach slideouts: Park brake must be engaged before operation the slideout rooms. The slideout room will not operate when Park Brake is released.
- On gas coach slideouts: Ignition key must be turned off or in accessories position before operating the slideouts. The slideout rooms will not operate when the ignition key is in the ignition ON position.

EXTENDING THE SLIDEOUT ROOM

1. Slideout end windows must be shut before moving room.
2. Look for and remove any obstructions before moving room.
3. Caution on motorhomes: Move driver seat forward before moving room.
4. If rooms are equipped with Manual Lock-Arms, be sure to release arms before running room out.
5. Press and hold the appropriate slideout switch until the slideout is fully extended and stops moving.
6. Release the switch. Note: The slideout room movement can be stopped at any time by releasing the switch.

RETRACTING THE SLIDEOUT ROOM

1. Slideout end windows must be shut before moving room.
2. Look for and remove any obstructions before moving room.
3. Caution on motorhomes: Move driver seat forward before moving room.
4. Press and hold the appropriate slideout switch until the slideout room is fully retracted and stops moving.
5. Release the switch. Note: The slideout room movement can be stopped at any time by releasing the switch.
6. If rooms are equipped with Manual Lock Arms, be sure to engage lock arm when rooms are in and before moving coach.

Manual Operation of Room

Refer to the Manual Operation Instructions located on the kitchen overhead cabinet.

INSTRUCTIONS

READ ENTIRE SLIDE-OUT ROOM INSTRUCTIONS BEFORE MOVING SLIDE-OUT ROOM

GENERAL INSTRUCTIONS:

- 1) On Diesel coach slide-out: Park Brake must be engaged before operating the slide-out rooms. The slide-out rooms will not operate when the Park Brake is released.
- 2) On Gas coach slide-outs: Ignition key must be turned off or in accessories position before operating the slide-outs. The slide-outs rooms will not operate when the Ignition key is in the Ignition ON position.

Extending Slide out Room:

- 1) Slide-out end windows must be shut before moving room.
- 2) Look for and remove any obstructions before moving room.
- 3) **CAUTION ON MOTORHOMES:** Move driver seat forward before moving room.
- 4) If rooms are equipped with Manual Lock-Arms, be sure to release arms before running room out.
- 5) Press and hold the appropriate slide-out switch until the slide-out is fully extended and stops moving.
- 6) Release the switch. Note: The slide-out room movement can be stopped at any time by releasing the switch.

Retracting Slide out Room:

- 1) Slide-out end windows must be shut before moving room.
- 2) Look for and remove any obstructions before moving room.
- 3) **CAUTION ON MOTORHOMES:** Move driver seat forward before moving room.
- 4) Press and hold the appropriate slide-out switch until the slide-out room is fully retracted and stops moving.
- 5) Release the switch. Note: The slide-out room movement can be stopped at any time by releasing the switch.
- 6) If rooms are equipped with Manual Lock-Arms, be sure to engage lock arm when rooms are in and before moving coach.

MANUAL OPERATION OF ROOM:
Refer to the MANUAL OPERATION INSTRUCTIONS located on the kitchen overhead cabinet.

Revision 01: 2018

INSTRUCTIONS

MANUAL SLIDE-OUT ROOM EXTENSION AND RETRACTING INSTRUCTIONS

READ ENTIRE SLIDE-OUT ROOM INSTRUCTIONS BEFORE MOVING SLIDE-OUT ROOM

MOTORS WITHOUT MANUAL DRIVE NUT:

- 1) Manual lock arms must be released from locked position prior to extending the room.
- 2) Access must be gained to the motor attachment bolts. Remove the bolts and slide the motor off the square part of the shaft.
- 3) Once the motor is off, the slide out can be pushed manually in or out.

MOTORS WITH MANUAL DRIVE NUT:
If the unit is equipped with the shaft through the gearbox motor which is mounted near the center of the slide-out room, use the following directions:

- 1) Manual lock arms and power locks must be released from locked position prior to extending the room.
- 2) Access must be gained to the slide out motor located in the center of the slide out room.
- 3) Releasing the motor's "Electro-Mechanical Brake": At the end of the motor remove the black plastic cover. Remove the tie-wrap and pull the cover off the motor. You must apply a 12 volt power source to release the brake. A source such as; a charged 9V battery will work. To apply the power source, separate the electrical connectors between the motor and brake and attach the connectors which lead to the brake to your power source. This will release the brake and allow manual cranking.
- 4) The manual extension or retraction requires only a 5/8" socket and ratchet wrench. By placing the socket on the 5/8" hex nut located on the gear box of the 900 motor, the slide-out can be moved in either direction by turning the hex nut.
- 5) If the slide-out does not move by using the hex nut, the room can be extended or retracted by using the procedure described for motors without the manual drive nut.

MANUAL OPERATION OF HWH ROOM:
Refer to the MANUAL OPERATION INSTRUCTIONS located in owners manual.

Revision 01: 2018

Slideout Safety

⚠ WARNING

Do not allow children to operate the slideout. Do not allow any person to place their arms, legs, body or head between any pinch point of the lock arms, slideout fascia, interior walls, exterior walls, objects, or floor as serious injury or death could result. Any adjustments, or repairs, must be made only by "Newmar" qualified personnel. Always check the interior and exterior of the coach for objects, or persons, that are in the path of the slideout when extending or retracting the room. Always check the room to be sure any objects, or debris, are removed before retracting the room. Operator must remain continually in control of the slideout room control switch while the room is moving in or out.

⚠ WARNING

Be sure that the driver's seat is in the forward position before activating the slideout room.

⚠ WARNING

Do not allow children to operate the slide-out. Do not allow any person to place their arms, legs, body or head between any pinch point of the lock arms, slide-out fascia, interior walls, exterior walls, objects, or floor as serious injury or death could result. Any adjustments, or repairs, must be made only by "NEWMAR" qualified personnel. Always check the interior and exterior of the coach for objects, or persons, that are in the path of the slide-out when extending or retracting the room. Always check the roof to be sure any objects, or debris, are removed before retracting the room. Operator must remain continually in control of the slide-out room control switch while the room is moving in or out.

NI-121

⚠ WARNING

Be sure that driver's seat is in the forward position before activating the slide out room.

NI-043

Electric Slideout Maintenance

This article provides care and maintenance information for the electric slideout. Electric slideout drive mechanisms do not require lubrication as part of the scheduled maintenance. Some noise is normal during extension and retraction from the various moving parts and seals.

Chains, Rollers, and Tubes

If lubrication is desired on chains, rollers, or tubes, Newmar recommends using a light coat of LPS 1 Greaseless Lubricant, which provides a dry, thin lubricating film that is resistant to dirt and dust buildup.

⚠ IMPORTANT

Newmar does not recommend the use of grease, silicone, or WD-40 on the slideout tubes or chains, as these products tend to collect dirt and dust.

Seals

If slideout seal lubrication is necessary, the slideout seal provider (Clean Seal) recommends using a silicone-based spray or water-based 303 protectant on the rubber slideout seals. They state this will not hurt the seal. They also stated that baby powder could be used but would need to be applied frequently, as it would wash away. The silicone base spray would last longer and would not need to be applied as often. Newmar recommends bi-annual treatment of slideout seals.

Motor Mounting Bolts

In addition, the torque on all electric slideout motor mounting bolts should be checked annually by an Authorized Newmar Service Center.

Cleaning The Slideout Rollers

This article provides information about when and how to clean the rollers on an electric slideout.

When To Clean The Rollers

⚠ IMPORTANT

It is important to clean the slideout rollers under the floor regularly. Dirt and other debris may adhere to the rubber coating on the rollers, which may lead to a dull finish, scratching, scoring, or further damage to the flooring. Such damage is NOT covered under warranty.

There is no set schedule for cleaning the slideout rollers. It will vary based on the cleanliness of the coach, and other factors such as dust, dirt, sand storms, as well as the type and condition of the roads traveled.

The following list provides examples of when the rollers should be cleaned:

- Liquid spills on the roller, floor, or under the slideout
- Fragments from broken glass, pottery, or other sharp objects on the roller, floor, or under the slideout
- Sand or other abrasive materials on the roller, floor, or under the slideout
- Hair wrapped around the roller or shaft
- The roller begins sliding on the floor instead of rolling smoothly

⚠ IMPORTANT

Slideout rollers may leave indentations in the flooring. This condition is normal and does NOT warrant flooring replacement.

How To Clean The Rollers

1. The slideout rollers can usually be accessed by extending the slideout half way.
2. Blow any remaining debris from under the slideout.
3. If possible, clean the ramps for the electric flat floor slideouts.
4. If more room is necessary to clean the ramp and rollers, push out on the top of the room and slide a wooden wedge between the floor and the bottom of the slideout in a few different places to create more clearance.
5. Clean the rollers one at a time with a soft cloth and a mild cleaner. A wet Swiffer cloth can also be used. Do not use harsh cleaners or solvents that may soften plastics.
6. Another alternative is to clean a portion of each of the rollers, then move the room slightly to clean the next portion. Repeat this process until all of the rollers have been cleaned all the way around.

Manually Retracting an R3 or O1 Series Electric Bedroom Slideout with a Square Shaft

This article provides instructions for manually retracting a bedroom slideout with a square shaft if it will not retract on its own.

⚠ IMPORTANT

If the slideout is stuck in the retracted position, take the coach to an authorized service center for diagnosis and repair. Do NOT attempt any of the following procedures.

⚠ IMPORTANT

Prior to proceeding with a manual retraction procedure, make sure the ignition key is in the off position and the park brake is set. Then, try retracting the slideout again, as some controllers require the ignition to be off, and others require the park brake to be set.

⚠ WARNING

The manual retraction procedures are for emergency use only. These procedures bypass all normal safety features. It is the responsibility of the person(s) performing the procedure to watch for moving parts and pinch points in order to avoid injury.

Option 1

This option requires the motor and gear box to be operational. This procedure bypasses the slide controller, switch, and the wiring. If battery power is unavailable, or if the motor/gear box is inoperable, move to a different option.

⚠ IMPORTANT

This procedure can be performed on any single motor electric slideout.

1. Disconnect the red and black wires connected to the motor.
2. Using the the wires attached to the motor, connect to a 12 volt cordless battery to retract the slideout. If the wire polarity is reversed, the slideout will extend instead of retract.

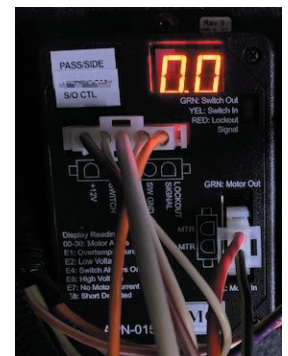

⚠ IMPORTANT

If the slideout motor has a brake installed, you must also hook one brake wire to the battery with the red slideout motor wire and one with the black slideout motor wire.

This can also be done at the slideout controller's wiring harness by removing the motor's red and black harness plug from controller and jumping a 12 VDC power source at the Molex plug.

3. Disconnect the wire(s) from the cordless battery pack.

Option 2

If the slideout is stuck in the extended position and option 1 is unavailable or fails:

COACHES WITH MANUAL LOCK ARMS

1. Remove the four mounting bolts, and move over the slideout motor until it disengages from the square shaft.
2. Manually push the room in or out.
3. Lock the room with manual lock arms (if equipped).
4. Take the coach to an authorized service center for diagnosis and repair.

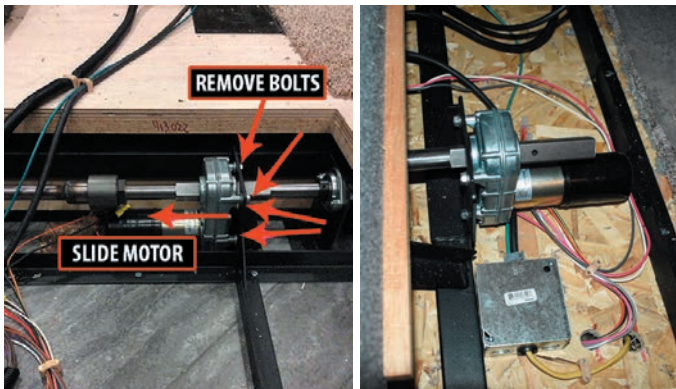
**COACHES WITH MECHANICAL LOCK ARMS**

1. Slide the motor back over onto the square shaft, and reinstall the four mounting bolts.
2. The motor and brake assembly must be installed (or another way devised) to hold the slideout in the retracted position prior to traveling.
3. Take the coach to an authorized service center for diagnosis and repair.

Manually Retracting a Single Motor Flat Floor or Wardrobe Slideout with a Square Shaft

This article provides instructions for manually retracting a single motor flat floor or wardrobe slideout with a square shaft if it will not retract on its own.

⚠ IMPORTANT

This procedure can be performed on coaches with a brake on the slideout motor.

Option 3

If the slideout is stuck in the extended position and option 1 and/or 2 is unavailable or fails, try the following steps to manually retract the slideout by removing the brake and turning the shaft. Only a few tools are necessary to complete this procedure; however, it requires the gear box to be operational.

⚠ IMPORTANT

Make sure you do not damage portions of the shaft that will slide through the motor, trantorque, bearing, and cog wheels.

1. First, locate the strap that secures the rubber boot on the outside of the motor.
2. Remove the strap, and pull off the rubber boot, removing it from the motor.
3. Remove the four screws from under the rubber boot on the brake.
4. Once the brake is removed, use a wrench to turn the shaft to retract the slideout.
5. After the slideout is fully retracted, reinstall the brake.



⚠ IMPORTANT

If the slideout is stuck in the retracted position, take the coach to an authorized service center for diagnosis and repair. Do NOT attempt any of the following procedures.

⚠ IMPORTANT

Prior to proceeding with a manual retraction procedure, make sure the ignition key is in the off position and the park brake is set. Then, try retracting the slideout again, as some controllers require the ignition to be off, and others require the park brake to be set.

⚠ WARNING

The manual retraction procedures are for emergency use only. These procedures bypass all normal safety features. It is the responsibility of the person(s) performing the procedure to watch for moving parts and pinch points in order to avoid injury.

Option 1

This option requires the motor and gear box to be operational. This procedure bypasses the slide controller, switch, and the wiring. If battery power is unavailable, or if the motor/gear box is inoperable, move to a different option.

⚠ IMPORTANT

This procedure can be performed on any single motor electric slideout.

1. Disconnect the red and black wires connected to the motor.
2. Using the the wires attached to the motor, connect to a 12 volt cordless battery to retract the slideout. If the wire polarity is reversed, the slideout will extend instead of retract.

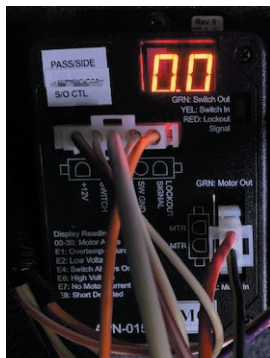

⚠ IMPORTANT

If the slideout motor has a brake installed, you must also hook one brake wire to the battery with the red slideout motor wire and one with the black slideout motor wire.

This can also be done at the slideout controller's wiring harness by removing the motor's red and black harness plug from controller and jumping a 12 VDC power source at the Molex plug.

3. Disconnect the wire(s) from the cordless battery pack.

Option 2

If the slideout is stuck in the extended position and option 1 is unavailable or fails, try the following steps to manually retract the slideout by removing the brake and turning the shaft. Only a few tools are necessary to complete this procedure; however, it requires the gear box to be operational.

1. First, locate the strap that secures the rubber boot on the outside of the motor.
2. Remove the strap, and pull off the rubber boot, removing it from the motor.
3. Remove the four screws from under the rubber boot on the brake.
4. Once the brake is removed, use a wrench to turn the shaft to retract the slideout.



⚠ IMPORTANT

Make sure you do not damage portions of the shaft that will slide through the motor, trantorque, bearing, and cog wheels.

On slideout motors equipped with the 5/8" reduction gear nut, it can be turned to retract the slideout.

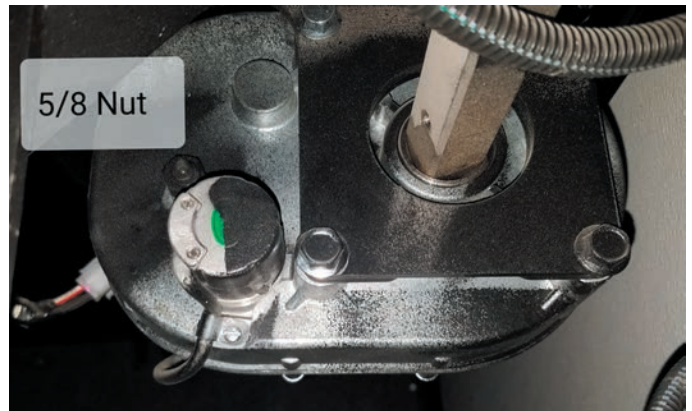

5. After the slideout is fully retracted, reinstall the brake.

Option 3 - Wardrobe Slideout Motor with Square Shaft

⚠ IMPORTANT

This procedure can be performed on coaches with a brake on the slideout motor.

IF THE SLIDEOUT IS STUCK IN THE EXTENDED POSITION

1. Remove the four mounting bolts, and move over the slideout motor until it disengages from the square shaft.
2. Manually push the room in or out, or use a wrench to rotate the shaft. Make sure you do not damage the shaft with the wrench.

WITH MANUAL LOCK ARMS

3. Lock the room with manual lock arms (if equipped).
4. Take the coach to an authorized service center for diagnosis and repair.

WITH MECHANICAL LOCK ARMS

3. Slide the motor back over onto the square shaft, and reinstall the four mounting bolts.
4. The motor and brake assembly must be installed (or another way devised) to hold the slideout in the retracted position prior to traveling.
5. Take the coach to an authorized service center for diagnosis and repair.



NOTICE

Depending on the year, model, and floorplan of the coach, the exact slideout motor(s) location may vary. Generally, they may be accessed from under the slideout in the compartment area. Some motors may also be located in the wheel well area under a cover.

Manually Retracting a Dual Motor Electric Full Wall or Kitchen Slideout with Square Shaft

This article provides manual retraction procedure options for a dual motor electric full wall or kitchen slideout with a square shaft.

Due to the dual motor setup, manual retraction using a separate battery or 12V source is not recommended since motors run at different speeds. This may increase the risk of binding the room and/or causing extensive damage to the drive assembly.

Option 1

IMPORTANT

This procedure can be performed on coaches with a brake on the slideout motor.

If the slideout is stuck in the extended position, try the following steps to manually retract the slideout by removing the brakes from each motor and turning the shaft. Only a few tools are necessary to complete this procedure; however, it requires the gear box to be operational and the person(s) retracting the room to keep the slideout from binding. This can be done by alternating moving each side in small increments or by turning each side simultaneously with a person at or near each motor or shaft assembly.

1. First, locate the strap that secures the rubber boot on the outside of the motors.
2. Remove the strap, and pull off the rubber boot, removing it from the motors.
3. Remove the four screws from under the rubber boot on the brake.
4. Once the brake is removed, use a wrench to turn the shaft to retract the slideout.

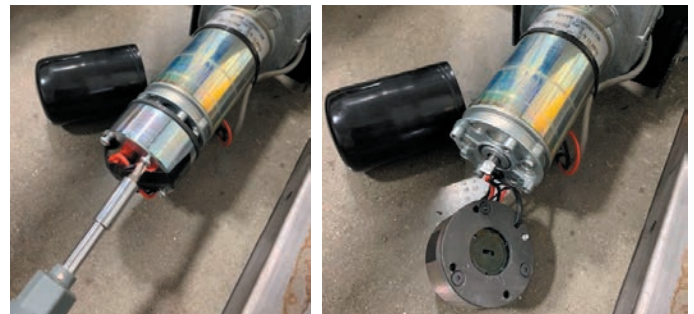

IMPORTANT

Make sure you do not damage portions of the shaft that will slide through the motor, trantorque, bearing, and cog wheels.

On slideout motors equipped with the 5/8" reduction gear nut, it can be turned to retract the slideout.



5. After the slideout is fully retracted, reinstall the brake.

Option 2

1. Remove the four mounting bolts, and move each slideout motor until it disengages from the square shaft.
2. Manually push the room in or out, or use a wrench to rotate the shafts. Make sure you do not damage the shafts with the wrench and keep the room in sync to prevent binding.

WITH MANUAL LOCK ARMS

3. Lock the room with manual lock arms (if equipped).
4. Take the coach to an authorized service center for diagnosis and repair.

WITH MECHANICAL LOCK ARMS

3. Slide the motor back over onto the square shaft, and reinstall the four mounting bolts.
4. The motor and brake assembly must be installed (or another way devised) to hold the slideout in the retracted position prior to traveling.
5. Take the coach to an authorized service center for diagnosis and repair.

NOTICE

Depending on the year, model, and floorplan of the coach, the exact slideout motor(s) location may vary. Generally, they may be accessed from under the slideout in the compartment area. Some motors may also be located in the wheel well area under a cover.



CARE AND MAINTENANCE

This chapter includes information about required and recommended maintenance, inspection of components, as well as other maintenance items to help retain the coach's dependability, safety, visual appearance, and resale value.

⚠ IMPORTANT

Read and follow all maintenance schedules to meet warranty requirements. Preventive maintenance and scheduled maintenance items are not warrantable. Damage caused by improper or unapplied maintenance is not covered by your Newmar Limited Warranty.

How to Weigh a Coach

This article provides the Newmar-recommended procedure for weighing the coach. Below are some samples of the weight information labels that may appear in your coach.

MANUFACTURED BY / FABRIQUE PAR:		DATE:	
GVWR/PNBV	KG (LB)		
GAWR/PNBE	KG (LB)	TIRES/PNEU	RIMS/JANTE
FRONT/AVANT	KG (LB)		COLD INFL. PRESS./PRESS. DE GONFL. A FROID
			(KPA SINGLE DUAL) PSI/LPC) <input type="checkbox"/> <input type="checkbox"/>
INTERM/INTERM	KG (LB)		(KPA SINGLE DUAL) PSI/LPC) <input type="checkbox"/> <input type="checkbox"/>
REAR/ARRIERE	KG (LB)		(KPA SINGLE DUAL) PSI/LPC) <input type="checkbox"/> <input type="checkbox"/>
THIS VEHICLE CONFORMS TO ALL APPLICABLE U.S. FEDERAL MOTOR VEHICLE SAFETY STANDARDS IN EFFECT ON THE DATE OF MANUFACTURE SHOWN ABOVE. THIS VEHICLE CONFORMS TO ALL APPLICABLE STANDARDS PRESCRIBED UNDER THE CANADIAN MOTOR VEHICLE SAFETY REGULATIONS IN EFFECT ON THE DATE OF MANUFACTURE. - CE VEHICULE EST CONFORME A TOUTES LES NORMES QUI LUI SONT APPLICABLES EN VERTU DU REGLEMENT SUR LA SECURITE DES VEHICULES AUTOMOBILES DU CANADA EN VIGUEUR A LA DATE DE SA FABRICATION.			
V.I.N./N.I.V.:		TYPE/TYPE:	

Cargo Carrying Capacity (CCC): The weight equal to GVWR, minus each of the following: UVW, full fresh (potable) water weight (including water heater), full propane gas weight, and SCWR. (CCC = GVWR - UVW - Water Weight - Propane Weight - SCWR)

Gross Vehicle Weight (GVW): The weight of the unit with all items and supplies that are loaded into the unit at any point in time.

Sleeping Capacity Weight Rating (SCWR): The manufacturer's designated number of sleeping positions multiplied by 154 pounds (70 kilograms).

MOTOR HOME OCCUPANT AND CARGO CARRYING CAPACITY	
VIN: #####	
THE COMBINED WEIGHT OF OCCUPANTS AND CARGO SHOULD NEVER EXCEED:	
XXX kg or XXX lbs	
Safety belt equipped seating capacity: XXX	
CAUTION:	
A full load of water equals XXX kg or XXX lbs of cargo @ 1 kg/L (8.3 lb/gal) and the tongue weight of a towed trailer counts as cargo	

Figure 1 - Motor Home Occupant and Cargo Carrying Capacity Label

⚠ IMPORTANT

To assure the accuracy of your weights, make sure the unit is always level during weighing.

⚠ IMPORTANT

The sales literature may give approximates or standards. Each individual unit may weigh differently based on the factory and/or dealer options added.

Weight Descriptions

The following definitions are provided to help with communication issues with weight and your coach.

Gross Axle Weight Rating (GAWR): The maximum permissible weight for an axle.

Gross Combination Weight Rating (GCWR): The value specified by the manufacturer of the vehicle as the maximum allowable loaded weight of the motorhome and any towed trailer or towed vehicle.

Gross Vehicle Weight Rating (GVWR): The maximum permissible weight of the fully-loaded motorhome. The GVWR is equal to or greater than the sum of the UVW plus the CCC. (GVWR ≥ UVW + CCC)

Unloaded Vehicle Weight (UVW): The weight of this motorhome as built at the factory with full fuel, engine oil, and coolants. The UVW does not include cargo, fresh water, propane gas, or dealer-installed accessories.

Weighing Your Coach

The unit has been built to comply with the component suppliers' recommended limits to provide you with a realistic CCC. When loading the unit, distribute the items so that not all of the weight is added to one area of the unit.

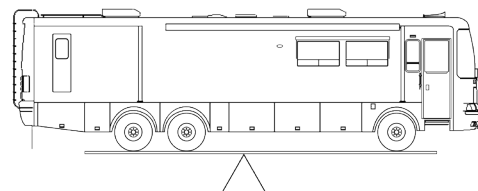

If you have questions as to what the weight of the unit is after it has been loaded, take the unit to a drive-on scale or use individual wheel scales, and verify that the weights are within the limits of those specified for the unit. When weighing the unit, follow these instructions. Failure to follow these instructions may give an erroneous weight reading.

To find the total weight of the unit, pull the unit onto the scales so that all of the wheels are on the scale as shown. Record the weight. This is the GVW and should not exceed the GVWR supplied by Newmar for the unit.

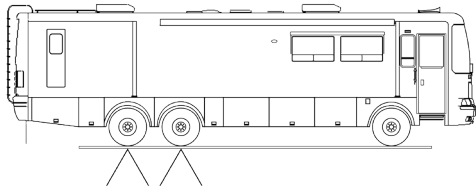

To find the total weight of the coach, except for the front axle, move the unit so that the front wheels are off the scales as shown. Record the weight. This weight should not exceed the total rating of the axles remaining on the scales. The front axle weight is determined by subtracting this weight from the GVW that was obtained in step one. This amount should not exceed the listed front axle weight rating.

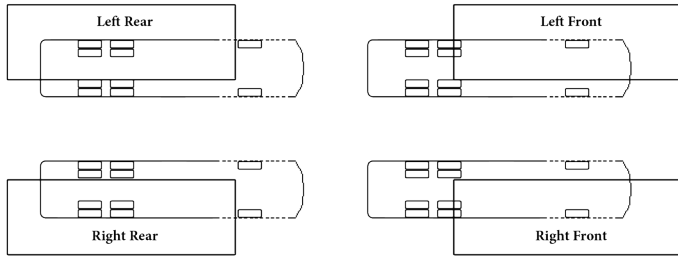

ALTERNATE WEIGHING PROCEDURE

The recommended procedure to accurately weigh a motorhome is on individual corner scales. Since these are not always available, this diagram shows how to weigh a motorhome on a typical truck scale.

Since only one corner can be weighed at a time, the remaining three corners need to be as close to the scale as possible without being on the scale, and the unit needs to be as level as possible. Remember, wind and rain can cause inaccuracies of weights.

⚠ IMPORTANT

Your coach has been aligned at the factory as part of the production process. To provide optimum tire longevity and offer the best handling characteristics, Newmar recommends you have your unit re-aligned after loading your belongings. Though highly recommended, this alignment is not mandatory, and as such, is not warrantable by Newmar or the chassis manufacturer.

How To Wash and Dry A Coach

This article provides the Newmar-recommended procedure for washing and drying the coach.

Washing The RV

The clear coat used on all painted portions of the exterior is a similar to the technology that used by car manufacturers. The same care needs to be performed and maintained on your coach exterior surface as on your automobile. Following these procedures can provide a long-lasting, high-gloss finish on your coach.

⚠ IMPORTANT

Do not use dish soap, detergents with degreasing agents, or industrial cleaners, as they can cause damage to the finish on your coach.

⚠ IMPORTANT

Do not use solvents such as acetone, MEK, toluene, etc. on the decals. Any solvent including alcohol may soften or smear colors. Do not use lacquer thinner or paint on decals. Do not overcoat the decals with clear paint. Do not allow gasoline or other fuels to drip or stay on the decals for any length of time. If this occurs, immediately flush the area with water.

1. Make sure the coach's surface temperature is under 90° F. Never wash the vehicle in direct sunlight, while the vehicle is hot, or with hot water.
2. Rinse the entire coach to remove all loose dirt and grime. Never hold a pressure washer close to the surface. Use a fan-type spray nozzle, making sure that the water is not a single straight stream. Keep the stream at least 18 inches from the edge of any decals, as high pressure water may cause the decals to loosen and peel.
3. Most car stores offer mild car wash shampoos that are safe for clear coat finishes. You may also use baby shampoo to prevent leaving a film on the coach. Adding ½ of a cup of food grade vinegar to three gallons of water will boost the cleaning ability and will also soften the water to help minimize water spots. Rinse thoroughly to prevent soap residue accumulation.

4. Use 100% cotton or Lambswool pads or wash mitts for washing the painted surfaces of your coach. Use a different mitt for washing the wheels and undercarriage.

The following products may assist you when cleaning your coach, and may be purchased through the Newmar parts department:

- Lambswool Pad (Newmar part #018461)
 - Backer Pad (Newmar part #018461A)
 - Lambswool Mitt (Newmar part #018464)
 - Extension Pole (Newmar part #018463)
5. Change the water in your wash bucket often, or place a "dirt guard" in bottom of the bucket to keep the cleaning pad or wash mitt free of dirt and debris.

⚠ IMPORTANT

Damage caused by improper or unapplied maintenance is not covered by your Newmar Limited Warranty.

⚠ IMPORTANT

Absolutely no brushes should be used on the painted surface of your coach, as it will cause damage to the finish, just as it would an automobile finish. Newmar does not support the use of any style, type, or brush material, even though it may be marketed as 'RV Safe' or 'Approved.'

⚠ CAUTION

The use of any cleaning products outside of Newmar's recommendation is at the customer's discretion. However, Newmar and BASF take no responsibility for any scratches, swirls, or damage to the finish of the coach caused by the use of non-recommended products.

Drying The RV

Drying your RV is just as important as washing it. Tap water and well water contain many chemicals that could water stain your coach's finish. After washing, dry your coach with the EZE Squeegee (Newmar part #018462) or a clean 100% leather chamois.

⚠ IMPORTANT

You can also use fresh microfiber towels for drying. Please use caution, as these towels are made partially with polyester (plastic), which can break down over time from extended use and washing, eventually causing damage to the clear coat finish.

Waxing and Polishing a Coach

This article explains the benefits and recommendations for using waxes and polishes to maintain your coach's finish.

The coating on your coach is a state-of-the-art base coat and Urethane clear coat. The clear coating is designed to protect the colored base coat, so it needs to be maintained, especially in harsh environments. Clear coats will appear to fade or lose gloss as the surface becomes contaminated by the environment. A finish that is dull or low in gloss is a result of contamination. Occasional washing alone will not adequately remove some forms of contamination and will require polishing of the finish.

The exterior finish of your coach will require a routine waxing. When water will not bead and roll off a freshly washed vehicle, a new coat of wax is needed. Wax not only improves the appearance of the vehicle, but it also protects the finish against oxidation and corrosive materials. The recommended type of wax is one that is compatible with painted or gel-coated fiberglass finishes, and contains a UV (ultra-violet) inhibitor. Buffing with a polishing compound will improve a dull or discolored finish.

⚠ IMPORTANT

When using a polishing compound that does not contain a wax preservative, reapplying a coat of hard wax after polishing is recommended.

⚠ IMPORTANT

Do not use products that contain harsh abrasives such as rubbing compounds, as these products should only be used by an experienced technician with proper training and equipment.

⚠ IMPORTANT

Refrain from waxing or polishing for at least 90 days from the coach's date of manufacture.

Benefits of Waxing and Polishing

- Remove minor surface imperfections caused by water spots and acid rain
- Remove minor scratches by filling them and leveling the surface
- Seal the pores of the finish, creating an easier-to-clean surface
- Beautify the paint finish appearance with more depth and high gloss
- Protect the paint finish from the elements

Most polishes and waxes are designed to clean and polish in one application, whether by hand or machine. A machine-applied polish will last longer than one applied by hand, as the high RPMs of the buffing wheel create heat, resulting in a deeper film with higher gloss. However, a hand-applied polish or wax will offer outstanding performance and protect the coach's finish.

Due to the variations of polishes and waxes, incorporate the following:

- Apply polish or wax while the coach is parked in a shaded area so the coach's surface is at the specified temperature according to the polish manufacturer's recommendations.
- Condition the polishing pad by rubbing a slight amount of polish on it.
- Use only the amount of polish specified in the label directions.
- Work a small area at a time.
- Rinse off and remove dried polish from crevices, trim, and moldings.

How to Clean Exterior Chrome

This article provides the Newmar-recommended procedure for maintaining your exterior chrome accessories.

1. Wash chrome items with soap and water the same way you wash the exterior paint.
2. If the chrome still has some tarnish and water spots on it, clean with a soft cloth and vinegar. Add a little baking soda to the rag if you need a stronger cleaner.
3. To clean rust off of the chrome, use a piece of crinkled aluminum foil dipped in vinegar. Scrub it with light to medium pressure, while making sure the foil stays wet with vinegar. In instances of rust and/or corrosion, you may use a very fine steel wool, but should be a last effort. Test it in an inconspicuous area to ensure no damage is occurring while using the steel wool.
4. Rinse the area with clean water after using any cleaning products.
5. Once the chrome is nice, bright, and shiny, dry it completely with a soft cloth.
6. Apply a coat of wax and buff it. Apply a second coat of wax, and buff it again.

⚠ IMPORTANT

The more often the chrome is cleaned, the easier the cleaning process. Coaches exposed to salt spray from the road or ocean air should be cleaned and waxed more often to maintain the best appearance.

How to Winterize a Coach

This article provides the Newmar-recommended step-by-step instructions for winterizing a coach.

⚠ NOTICE

The following instructions are generic to Newmar coaches, and are NOT specific to your coach. They should only be used as a reference guide for this process. Appliances, drain locations, and plumbing components may vary by coach. The following images are for example purposes only. Your coach may or may not be equipped with the same components as shown.

Follow the winterizing instructions to reduce the risk of leaks caused by cracks from freezing pipes. Damage caused from the fresh water system freezing can be extensive and costly to repair. A new coach may be equipped with a similar label if the system has been winterized.

⚠ IMPORTANT

Once water has been introduced into the system, it is no longer protected and must be winterized again any time the coach may be subjected to freezing temperatures.

This fresh water system has been protected with non-toxic anti-freeze. Please flush and drain lines before using.

AD-70



Gas Coach Water Compartment (Example Only)



Diesel Coach Water Compartment (Example Only)



Luxury Coach Water Compartment (Example Only)

When to Winterize a Coach

Although great care has been taken to build a well-insulated unit, recreational vehicles are not intended for extended use in sub-freezing weather without special precautions. When the outside temperature drops below freezing, the furnace must be turned on to keep the coach warm. Continued use in cold weather will require the coach to be winterized.

It is critical to winterize the plumbing in your coach when storing it in temperatures below freezing or using it in extremely cold conditions. If subjected to these conditions without being properly winterized, the heating system may be unable to keep the coach and its compartments above freezing temperatures.

WARNING

Winterizing is the responsibility of the consumer. Make sure you have protected the complete water system any time your coach is in freezing temperatures. Failure to complete the winterization process may result in extensive damage to the water system, appliances, and coach.

IMPORTANT

A regulated compressed air supply is needed to properly complete this procedure. The pressure should be regulated between 40 and 60 PSI (pounds per square inch). Higher pressures may cause damage.

How to Winterize a Coach

1. Drain the black and grey tanks. If equipped, also empty the macerator hose.
2. Drain the Fresh Water Tank. Open the tank drain valve located in the driver side water bay.
3. Turn off the switch(es) to the water heater or the hydronic heating system, including the burner and the 120 Volt element, depending on your coach's equipment.
4. Turn on the refrigerator.
5. While the tank is draining, remove all of the water filters. Install a bypass or the filter canister, including the whole house, refrigerator, and drink water filters (whether standard or UV), if your coach is equipped.



3 Bypass Valve System



2 Bypass Valve System

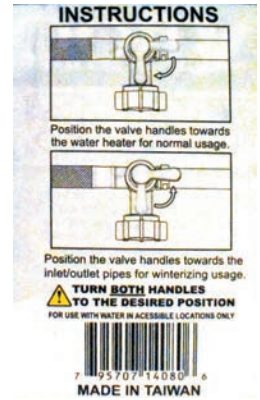

6. For units with a tank-style water heater instead of a hydronic heater, close the valves to the water heater, and open the bypass valve, which is normally located at the back side of the water heater. Depending on your particular floor plan, access to the back of the water heater may be located in a cabinet, the closet, or in an exterior compartment.

NOTICE

For units with a tankless water heater, do NOT put the water heater in by-pass mode. Instead, blow it out, and install the antifreeze as directed for a hydronic heater.

7. Remove the drain plug at the bottom of the water heater tank on the exterior of the coach.

IMPORTANT

The 120 Volt water heater element must be turned off by flipping the switch near the water heater's drain plug.

8. Open the low point drains by turning the valve to the "open" position or by pulling up on the handle if the coach is equipped with T-Handle valves. There should be one drain for hot and one for cold, and they are normally located in the water compartment.
9. Connect the regulated air supply to the inlet of the hose from the hose reel (if equipped) or the city water fill inlet using a blowout plug. Air will flow out of the low point drains.
10. Cycle all faucets and the auto fill or tank fill valve (whichever the coach is equipped with) to all possible positions for a minimum of 10 seconds at each position. Do not forget the hot water spigot with low point drain next to the generator (if equipped).
11. Cycle the tank fill valve to all positions in order to purge water out of the lines and valve assembly.

⚠ IMPORTANT

On coaches equipped with Aqua View Showermi\$er Fresh Water Reclamation System, cycle the valve to the bypass position to purge the water out of the line back to the fresh water tank while pressurized air supply is connected. Then place the valve back to normal flow mode to the shower head, and then purge the shower. Do not leave the valve in bypass mode when running antifreeze in the line because it will allow antifreeze into the fresh tank.

12. After blowing the water out of the system with pressurized air, disconnect the hose, and pour approximately one cup of antifreeze into the hose. Hook the hose back up to the pressurized air, and blow the antifreeze through the hose and hose reel to protect it.
13. Close the low point drains. This must be done prior to pumping antifreeze through the lines, or the antifreeze will be pumped onto the ground.
14. Remove the whole house filter canister, and dump any remaining water, and reinstall.
15. Locate the winterizing valves marked “A” & “B” located in the water compartment.
16. Close valve “A” by rotating the valve clockwise. Open valve “B” by rotating the valve counter clockwise.
17. Remove the plug at the end of the clear winterizing hose.
18. Insert the hose into a jug or bucket of antifreeze.
19. Replace the empty jugs, or refill the bucket as needed to complete the entire process.
20. Turn on the water pump by activating water pump switch. Red antifreeze will start flowing through the clear hose into the water lines.
21. Run cold water from the kitchen faucet until the red potable antifreeze is detected. Run hot water from the kitchen faucet until the antifreeze is detected.

⚠ IMPORTANT

Make sure you run enough antifreeze through each faucet to fill each P-trap.

22. Proceed to the next faucet, and repeat process for each faucet, including the lavatory, shower sprayers, and outside shower faucet. If equipped, repeat the process for the instant hot water, drinking water dispensers, and hot water spigot with low point drain (next to the generator).
23. Flush each toilet until the red antifreeze is detected. If the toilet is equipped with a sprayer, activate and flush it until the antifreeze flows from the sprayer.

⚠ IMPORTANT

For coaches equipped with a sink or shower connected to a Saniflo Sanivite lift pump, the lift pump must be completely emptied, or enough RV antifreeze must be poured down the drains to allow the lift pump to cycle until the antifreeze concentration is sufficient for freeze protection. Pour at least one liter of antifreeze down the drain connected to the lift pump. Make sure the pump cycles at least once, then pour another liter down the drain. Wait for the lift pump to cycle again; then the remaining liquid in the lift pump should have an adequate antifreeze concentration at this point.

24. Run the dishwasher through a cycle to winterize the water inlet plumbing, as well as the pump and drain line.
25. If the coach is equipped, turn on the washing machine. Select a wash cycle setting that uses warm water to activate both the hot and cold inlet valves. Allow the washing machine to fill for approximately two minutes. Press the “cancel” and “drain” selection to begin draining the machine. This will winterize the pump and drain, as well as the washing machine’s P-trap.
26. Depress the refrigerator’s external water dispenser while holding a container to catch the fluid. Continue to let the fluid flow until the red antifreeze is detected.

⚠ NOTICE

The red antifreeze may not appear instantly, as most refrigerators have a reserve for cold water. However, if you did not remove the water filter in the refrigerator in Step 5, the fluid will run clear for a long time.

27. Make sure the ice maker is turned on. Once it reaches the proper temperature, it will attempt to make ice cubes, which will become pink in color. This may take several hours. Once they become pink, turn off the ice maker and the refrigerator. Empty the ice cube tray, and clean out the ice maker and freezer area.
28. Turn off the water pump. Close the winterizing valve “B”, and open valve “A”.
29. Insert the plug into the clear hose, and stow the winterizing hose.
30. If the coach is equipped, winterize the macerator by turning it on and emptying the black and gray holding tanks, allowing the macerator and macerator hose to fill with antifreeze. If there is no macerator in the coach, use the sewer hose to drain the black tank, followed by the gray tank.

How to De-Winterize a Coach

This article provides the Newmar-recommended step-by-step instructions for de-winterizing a coach.

1. Connect your water hose to a fresh potable water supply.
2. Set the auto fill or tank fill valve for city water supply.
3. Run water through each faucet, toilet, and shower on both hot and cold settings.
4. Run the dishwasher and the washing machine through a complete cycle before using.
5. Depress the refrigerator water dispenser while holding a container to catch the fluid being dispensed. Continue until clear water is dispensed.
6. Install the refrigerator filter (if equipped).
7. Turn off the water supply drain pressure from the system using low point drains. Install all filters in the system.
8. Close the low point drains.
9. Turn on the ice maker, allowing it to run through multiple cycles. Throw away any ice with antifreeze. Clean out the ice maker and the tray until clear ice is available.
10. If the coach is equipped with a water heater, install a drain plug. Open the water heater valves, and close the by-pass valve on the back side of the water heater.
11. Turn on the fresh potable water supply.
12. Open the hot water faucet until the water heater is filled and flows through the faucet without air.
13. Flip the water heater switch to the "ON" position. This is located near the drain plug (if equipped with a water heater).
14. Check the tank level, and dump if necessary.
15. The coach is now ready to use.

⚠ NOTICE

Newmar recommends installing clean filters unless the sanitization process will also be completed at this time.

How To Sanitize The Water System

This article provides the Newmar-recommended step-by-step instructions for sanitizing a complete water system.

⚠ NOTICE

The following instructions are generic to Newmar coaches, and are NOT specific to your coach. They should only be used as a reference guide for this process. Appliances, drain locations, and plumbing components may vary by coach.

Follow the sanitizing instructions to reduce the risk of fresh tank contamination. All of the water should be drained from the fresh water system when the coach is not in use for more than one week. Whenever possible, drain the fresh water tank before traveling or only carry what you will need to get to your destination. Water in the tank will reduce the carrying capacity of the coach.

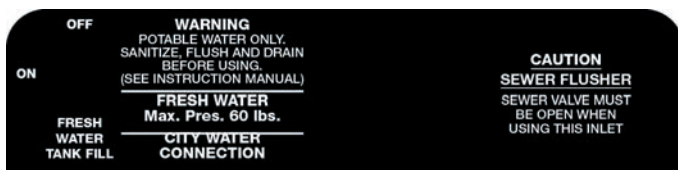

When To Sanitize The Water System

Newmar recommends sanitizing your water system under the following scenarios to discourage organic growth and contamination:

- Purchasing a new or used coach
- After your coach has been in storage for a lengthy amount of time
- At least once per year for proper maintenance
- If an unpleasant odor arises from your water

⚠ NOTICE

The Fresh Water System may need to be sanitized more often depending on the source of the water supplied to the coach.

How To Sanitize The System

1. Drain the fresh water tank by turning the tank drain valve to the open position.
2. Drain the water heater (if equipped) by removing the drain plug.

⚠ NOTICE

Do not attempt to drain the water heater when the water is hot or the system is pressurized, as scalding may occur.

While the tank is draining, remove all of the water filters, including the refrigerator and drinking water filters (standard or UV), if your coach is equipped, and install a bypass.

⚠ NOTICE

Not all filters have a 'bypass,' so it may be necessary to install the canister without the filter.

3. Remove the main (whole house) filter housing.
4. Remove the filter, and pour household bleach (1/4 cup per 15 gallons, as determined by your tank capacity) into the filter housing. For example: 1.75 cups of bleach for coaches equipped with a 105 gallon fresh water tank or 1.25 cups of bleach for coaches equipped with a 75 gallon fresh water tank. This will approximately be a 50 ppm (parts per million) bleach solution.

⚠ NOTICE

For any coaches not equipped with a whole house filter, skip these steps. Instead, use a funnel to pour bleach into the hose prior to hooking the coach up to a potable water supply.

5. Reinstall the housing and the water heater drain plug after it has drained completely.
6. Hook up the water hose from the hose reel (if equipped), or hook up a drinking water-safe portable hose to a potable water source.
7. Turn the valve to 'tank fill' or 'manual tank fill.'
8. Turn on the potable water source, and completely fill the water tank. (This will flush the bleach/water solution from the filter housing [Step 4] into the water tanks.)
9. Turn off the tank fill valve (on non-auto fill coaches).
10. Turn on the water pump.
11. Run water out of one faucet on both hot and cold settings until a strong bleach smell becomes evident.
12. Repeat this for all faucets, as well as the refrigerator, dishwasher, washing machine, toilets, low point drains, etc.

⚠ NOTICE

Top off the water tank so that the sides and top of the tank are sanitized as well.

13. Turn on the refrigerator and the ice maker. Depending on your refrigerator model, the ice maker may have a flip lever or an ON/OFF switch. Let the ice maker run until the bleach/water solution is detected. This may take a few cycles. One cycle consists of the ice maker filling the trays with water, freezing the water, and then dumping the ice into the ice bin. This cycling process will occur automatically if the refrigerator, the ice maker, and the water pump are all turned on.
14. Disconnect the water hose, and dump out some water.
15. Pour one ounce (1 oz.) of bleach into the water hose, and reconnect it to the potable water supply.
16. Turn on the water for a brief moment to flush the bleach through the water hose, allowing it to mix in the hose reel or the portable hose used for potable water.
17. Turn off the water supply, and disconnect the water hose.
18. Cap the end of the hose.
19. Let the bleach water sit in the system for a minimum of four hours. However, for best results, allow the solution to sit overnight or up to 12 hours.
20. Drain the fresh tank using the drain valve.
21. Fill the fresh tank with clean potable water.
22. Run water out of each faucet on both hot and cold settings until the bleach smell is no longer evident.

⚠ NOTICE

If the bleach smell is still noticeable, repeat steps 21-22 to flush the system again.

⚠ IMPORTANT

If algae or slime is detected in the fresh water system, it may be necessary to repeat the entire process until the system is flushed clean.

Once the system is flushed, Newmar recommends replacing the water filters. Do not re-use the contaminated filters, as this will greatly reduce the effectiveness of the sanitization process.

⚠ NOTICE

Sanitizing through the winterization process will not sanitize the fresh tank or all of the water lines.

Routine Maintenance Schedule (Gas Coaches)

This article provides the Newmar-recommended routine maintenance schedule for gas coaches.

All routine maintenance is the responsibility of the owner and is not covered by the Newmar Limited Warranty. Please note that damage caused by improper or unapplied maintenance is not covered by the Newmar Limited Warranty.

Items supplied by other manufacturers may require specific individual maintenance not listed herein. Please refer to the manufacturers' suggested maintenance guidelines in the Owner's Information Packet.

⚠ IMPORTANT

Always follow the chassis maintenance guidelines found in the chassis manufacturer owner's manual.

⚠ IMPORTANT

Cosmetic adjustments and alignments must be performed within the first three (3) months from date of original purchase for warranty consideration. Thereafter, these items are considered routine maintenance.

Description	Weekly	Monthly	Quarterly	Bi-Annually	Annually
Test smoke alarm, carbon monoxide detector, and propane gas detector.	X				
Check battery water level (liquid lead acid batteries only).		X			
Clean range hood exhaust fan filter and blades.			X		
Check LP gas lines for leaks with soap solution or leak detector.			X		
Check coach charging system and inspect battery connections/fluid levels.			X		
Inspect and clean slideout rollers on each slideout.			X		
Inspect the exterior rubber slideout seals, and apply a UV inhibitor, such as 303 Protectant.				X	
Have the propane system inspected by a qualified technician.				X	
Check operation of windows, latches, and hinges.				X	
Check and replace water filters.				X	
Clean the roof ducted air conditioner filter(s).				X	
Service each roof air conditioner per manufacturer requirements.				X	
Clean and inspect all door and window seals, and reseal where necessary.				X	
Inspect and reseal around the tub and shower area where necessary.				X	
Lubricate the exterior door hinges and latches with a graphite (silicone) lubricant.				X	
Check, clean, and tighten battery cables, and inspect batteries for proper fluid level.				X	
Inspect roof seams and joints (should be performed by an Authorized Newmar Service Center. If resealing is necessary, it is the owner's responsibility and is not covered by the Newmar Limited Warranty).				X	
Check all gas appliances for proper operation.				X	
Check BIRD/BIM bi-direction charging system.				X	
Check exterior lights, including tow plug					X
Perform generator oil, fuel, and air filter change					X
Lubricate the moveable parts on the entrance step.					X
Inspect the slideouts for proper seals. If realignment is necessary, please contact an Authorized Newmar Service Center.					X
Sanitize the fresh water system.					X
Wax and buff all gel-coat surfaces on the vehicle.					X
Check mounting bolts on all electric slideout motors for proper torque. This should be performed by an Authorized Newmar Service Center. If any bolt is under-torqued, remove the bolt, and add blue LOCTITE® thread sealant to the bolt threads. Reinstall and torque all 5/16" bolts to 19 ft. lbs. and all 3/8" bolts to 33 ft. lbs.					X
Refrigerator (House-type) - Annual maintenance (includes water and air filter)					X
Refrigerator (Absorption-type) - Supplier required maintenance (clean burner, cooling unit's flue and spiral baffle, roof cap screen or upper side vent. Check control board sequence for correct functionality).					X
Service forced air furnace					X
Service LP water heater burner, flush tank, and check anode rod					X
Water pressure / leak test / flush system / sanitize all tanks					X
Service jacks / leveling system					X

Source: Newmar Factory Service Center Routine Maintenance Schedule

Chassis Service / Maintenance

⚠ IMPORTANT

Always follow the chassis maintenance guidelines found in the chassis manufacturer owner's manual.

Description	Every Month	Every 6 Months OR Every 7,500 Miles	Every 12 Months OR Every 15,000 Miles	Other
Check engine oil level.	X			
Check function of all interior and exterior lights.	X			
Check tires (including spare, if applicable) for wear and proper pressure.	X			
Check windshield washer fluid level.	X			
Change the engine oil and filter.		X		
Rotate the tires, inspect tire wear and measure the tread depth.		X		
Inspect the wheels and related components for abnormal noise, wear, looseness or drag.		X		
Check battery connections. Clean if necessary.		X		
Check cooling system fluid level and coolant strength.		X		
Check hinges, latches and outside locks for proper operation. Lubricate if necessary.		X		
Check parking brake for proper operation.		X		
Check safety belts and seat latches for wear and function.		X		
Check safety warning lamps (brake, ABS, airbag and safety belt) for operation.		X		
Check washer spray and wiper operation. Clean or replace blades as necessary		X		
Perform a multi-point inspection, as recommended by Ford dealer.		X		
Inspect the automatic transmission fluid level. Consult dealer for requirements.			X	
Inspect the brake pads, shoes, rotors, drums, brake linings, hoses and the parking brake.			X	
Inspect the engine cooling system strength and hoses.			X	
Inspect the exhaust system and heat shields.			X	
Inspect the steering linkage, ball joints, suspension, tie-rod ends, drive shaft and the U-joints. Lubricate grease fittings, if applicable.			X	
Replace the engine air filter. (Every 30,000 miles)				X
Replace the front wheel bearing grease and grease seal if you use non-sealed bearings. (Every 60,000 miles)				X
Replace the spark plugs. (Every 97,500 miles)				X
Change the engine coolant. (At 105,000 miles)				X
Replace the rear axle fluid. (Every 105,000 miles)				X
Inspect the accessory drive belt(s). (Every 105,000 miles)				X
Replace the accessory drive belt(s) if not replaced within the last 100,000 mi (160,000 km). (Every 150,000 miles)				X
Replace the front wheel bearings and seals if you use nonsealed bearings. (Every 150,000 miles)				X
Change the automatic transmission fluid and filter. Consult dealer for requirements. (Every 150,000 miles)				X

Source: Ford F-Series Super Duty Class A Motorhome and Commercial Chassis Owner's Manual

When You Know The Difference.



Newmar Corporation | 355 N Delaware St | PO Box 30
Nappanee, IN 46550-0030 | 574-773-7791 | Fax 574-773-2895
NewmarCorp.com