

NEWMAR | 2023

MOUNTAIN AIRE

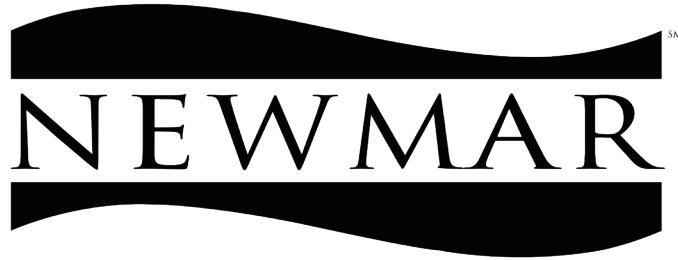



WHEN YOU KNOW THE DIFFERENCE™

Mountain Aire Owner’s Guide
Table of Contents

Introduction.....1

Safety9

Appliances 25

Chassis 43

Electrical 69

Electronics.....103

Entertainment Systems.....135

Exterior153

HVAC.....167

Interior179

Plumbing.....191

Slideouts.....213

Care and Maintenance225

⚠ IMPORTANT

This Owner’s Guide is a compilation of quick start guides for various components in your coach and should not take the place of the complete Operation Manual(s) provided by this component manufacturer(s). Refer to the complete manuals provided by the component manufacturers, which may be located in your owner’s information package and/or Newgle.

⚠ NOTICE

This Owner’s Guide is published and printed from Newmar’s online knowledgebase. For the most up-to-date version of this content, and for more product-specific information, how-to articles, and troubleshooting information, please refer to Newgle. All of the information in Newgle is believed to be accurate at the time of publication. However, it may be necessary to make revisions, and Newmar reserves the right to make any such changes without notice or obligation.



This page is intentionally blank.



INTRODUCTION: ABOUT NEWMAR AND YOUR NEW COACH

This chapter provides you with an introduction to Newmar, our warranty process, as well as our seamless service promise. As part of the Newmar family, you now have access to 24/7 support via your designated brand specialist and Newgle, our online knowledgebase.

Newmar's Limited Warranty and Customer Support

Welcome to the exciting world of recreational vehicles and the growing Newmar family! Congratulations on your purchase of a Newmar product! Your coach proudly carries the Newmar torch, as a new generation of RV'ing begins. We share your excitement, and look forward to the years and miles of adventure the RV lifestyle offers you in your coach.



WHEN YOU KNOW THE DIFFERENCE

Whether camping at your favorite remote fishing hole or tailgating at the big game with your friends, Newmar is with you 24 hours a day, 7 days a week.

The Newmar Legacy

Your new coach was built with care using today's technology and old world craftsmanship. At Newmar, we strive to build vehicles that are safe, dependable, and comfortable. Born on Christian principles, and from the desire to build not the most, but the best, the legacy associated with the name Newmar is one of family pride and quality. It is the culmination of decades of RV design and building experience.

We take humble pride in our history of innovation. We introduced the industry to the first slideout rooms, and continued our tradition of innovation with the first flush floor slideout in a motorized coach and the smooth, seamless fiberglass body. Your coach is at the forefront of current technology, built by the skilled hands and quality conscious eyes of craftsmen.

At Newmar, we recognize that a craftsman's final product is only as good as the materials they use, so we are selective about what we put into our coaches. We start with a foundation forged in the strength of steel and aluminum. We fill it with beautiful, durable hardwoods, and select name brand appliances and components, then build it on a chassis built to stand the test of time. Then we finish our units with an artist's gentle touch.

The Newmar Warranty

We stand behind our work with an exceptional warranty and dependable service, so you can travel with the kind of confidence that comes from knowing you're protected. What helps Newmar stand out against other manufacturers is our commitment to following our customers throughout the repair process to ensure any issues get taken care of the right way, right away.

LIMITED ONE-YEAR UNLIMITED MILE WARRANTY

Every Newmar motor coach is backed by our one-year, unlimited-mile expressed limited warranty.

LIMITED FIVE-YEAR STRUCTURAL WARRANTY

If any part of your Newmar recreational vehicle superstructure (which is the steel / aluminum structure of the sidewall, roof or frame) fails to perform properly within five (5) years from the date of purchase because of faulty workmanship or material supplied by Newmar, it will be repaired without charge for either parts or labor by Newmar. This structural warranty is available only to the original purchaser and is non-transferable.

CHASSIS AND COMPONENT MANUFACTURER WARRANTIES

Please read the Newmar Limited Warranty and all other component warranties that apply to the equipment installed on your unit. The limited warranties issued by the chassis and component manufacturers require periodic service and maintenance. The owner's failure to provide this service and/or maintenance may result in the loss of warranty coverage.

Be sure to file the appropriate registration card with the component manufacturer as described with the individual instruction booklets to activate the warranties on the components within your Newmar coach.

If you, for any reason, have a problem obtaining satisfactory and timely warranty service that may substantially impair the use, value, or safety of your Newmar coach, please call Newmar Customer Service toll free at **1-800-731-8300 (option #2)**.

Customer Support

Carefully read both the instructions in your Owner’s Guide, as well as the booklets supplied by the chassis and component manufacturers for important operation, safety, and maintenance information. This Owner’s Guide should be kept in your vehicle for quick reference. Take time to get acquainted with your unit and how it operates. Should you have any questions, consult your dealer or the Newmar customer support team. In addition to the assistance you receive from the customer support team, we are also excited to announce a new approach to customer service: Newgle.

Newgle is Newmar’s dynamic, multi-faceted knowledge center and is created specifically for Newmar coach owners and certified technicians. Because content pertaining to your coach is constantly evolving and changing, the only way we can provide you with access to the most up-to-date and relevant information is by linking you directly to it!

Much of our information comes directly from the manufacturer of the items that are specific to your coach model and year, so we urge you to check out the site for any additional information that may not (currently) be included in your owner’s guide. For more information, refer to the Introduction to Newgle article.

About The Delivery Process

This article provides a detailed list of the customer and dealer responsibilities during the delivery process.

Throughout the manufacturing process, your vehicle has been inspected by Newmar qualified technicians. However, our final inspection at the factory is not to be the last one. The pre-delivery inspection and systems check your dealer performs are the final inspections done to the unit prior to you receiving your new coach. Your dealer may assist you in understanding the limited warranties and with completing all warranty forms for the various appliances and accessories installed in your unit.

Customer Responsibilities

To assist you in avoiding problems with your vehicle, we recommend you do the following:

1. Read the warranty. Go over it thoroughly with your dealer.
2. Inspect the vehicle. Do not accept delivery until you have gone through the coach with the dealer. Newmar has provided a checklist to be used during retail delivery. Check each item on the list, and make sure the dealer does the same. Do not sign this checklist until you have done checked off each item.
3. Ask questions about anything that you do not understand concerning your recreational vehicle.
4. Responsible Use. Your vehicle is designed to be used for recreational or temporary living purposes. It is not designed to be used as a full-time residence or for commercial use. Commercial use means using as a business asset, such as a mobile office or using the vehicle for lease/rental purposes.

NOTICE

The sales literature versus actual specifics to the vehicle’s measurements, weights, or quantities may vary.

Dealer Responsibilities

1. A pre-delivery inspection and systems check: thoroughly inspecting the vehicle and the operation of the factory installed components.
2. A customer walk-through to familiarize the customer

with the vehicle, its systems and components, and their operation.

3. Delivery of the Owner’s Information Package. This package contains the warranty cards and registrations for the vehicle and factory- installed components that carry a separate warranty. The detailed operating and maintenance instructions on these components are also included in this package.
4. Assisting the customer in completing the component registration forms, at the customer’s request. To avoid loss of warranty coverage, the dealer should review the limited warranty provisions with the customer, stressing the importance of filing warranty cards and registrations to the component manufacturers within the prescribed time limit.
5. Providing the customer with information regarding warranty and non-warranty work on the vehicle, as well as its separately warranted components, whether the customer is in or out of the area.

Owner's Information Package and Appliance Data Sheet

This article provides information about the appliance data sheet posted in the coach, complete with details about coach-installed equipment, as well as the owner's information package.

⚠ NOTICE

The Newmar Owner's Guide, Information Package, and Appliance Data Sheet must not be removed from the vehicle in the event that the coach is sold. These items should remain with the coach for the next owner.

Owner's Information Package (Black Bag) and Newmar Owner's Guide

Included in your Owner's Information package are valuable documents about your vehicle and its components and systems. The Newmar Owner's Guide does not cover every possible detail of the equipment (standard and/or optional) installed on or in your coach. Consulting the booklets and instruction manuals in this package will help you safely operate, maintain, and troubleshoot these items. For more details about each of the components and systems installed in the coach, refer to Newgle.



⚠ IMPORTANT

Read all of the information and understand the safety and operating instructions included in the Owner's Information Package. To assure full warranty coverage, it is essential that all maintenance instructions are followed.

Appliance Data Sheet

An information sheet is provided containing important information about your coach for your convenience.

- Your coach's Newmar Serial Number. This number is needed whenever making an appointment for service or ordering parts through your Newmar Dealer or Service Center.
- Your coach's Vehicle Identification Number (VIN). The VIN is the legal identification of the completed vehicle and is used by the state for vehicle registration.
- Your coach's Year, Model, Type, and Floorplan.
- Manufacturer, Model, and Serial Number of factory-installed equipment. **Use these model numbers to quickly locate relevant information in Newgle about the parts, including links, files, and articles.**

⚠ IMPORTANT

The manufacturer, model, and serial number of the appliances and accessories installed at the factory in your coach are listed on this label for convenience. It is important that the label remains in the coach for identification purposes. Do not remove or relocate this label.

THANK YOU FOR PURCHASING A QUALITY NEWMAR PRODUCT! FOR YOUR CONVENIENCE, WE HAVE ENCLOSED A SERIAL NUMBER LIST OF IMPORTANT EQUIPMENT INSTALLED IN YOUR 2022 DDDP 4362 THE SERIAL NUMBER FOR YOUR UNIT IS - 468220 VIN# 4VZAD19VLC08331 DECOR 107 WOOD COLOR CARPET, GRADED CHESTY-BOND-85

DESCRIPTION	MODEL	SERIAL NUMBER
DASH A/C	RY202058	468073
DEFROSTER 1	M2812	W61-07991
FRONT RADIO	XP901118	S18-03314
MONITOR	AD0713	009518P7003745
JACK PUMP	AP58662	1838
JACK LEFT FRONT	AP37791	23856
JACK RIGHT FRONT	AP37791	23855
JACK LEFT REAR	AP53137	3127
JACK RIGHT REAR	AP53137	3123
REFRIGERATOR	WSP608EYMO5	V083384967
RANGE	2272	
WASHER	AKWXP15W	807279188
DRYER	17M61X	809120216
MICROWAVE	YVMD78019HE1	TR84513896
FRIGER	CF80	02141318770082
TOILET 1	8740	84897574
FRONT TV	60N0900	816162
REAR TV	43N0900	924441
TV #3	43N0900	924442
GENERATOR	10H0CA-12607B	K180493716
FRONT A/C	651818T5100	84524097
CENTER A/C	651818T5100	83921665
REAR A/C	651818T5100	83921664
REAR CAMERA	VCM012R	R1118TCTW00904
SAFE	PWS-1822R	L055982100289
SATELLITE #1	RTT-20B	1031180400492784
EXT TV	43N0900	04363
SLIDE ANNING 1	00	00
ANNING ARM 1	00	00
ANNING DOOR	00	00
WINDOW 1	00	00
WINDOW 2	00	00
WINDOW 3	00	00
WINDOW 4	00	00
WINDOW 5	00	00
SO TOPPER 1	00	00
SO TOPPER 2	00	00
SO TOPPER 3	00	00
SO TOPPER 4	00	00
SOPA 2	147234	
CAPT CHAIR DRIVER	99205 003	
CAPT CHAIR PASSENGER	99205 002	
SATELLITE #2	SPW-300	1121180400499394
FIBERGLASS SIDEWALLS (da)		012018854
FIBERGLASS SIDEWALLS (oda)		012018853
ANNING ARM 2	00	00
FIBERGLASS FRONT S/O (da)		120116058
FIBERGLASS REAR S/O (da)		012018856
FIBERGLASS FRONT S/O (oda)		012018857
SIDE CAMERA	VCM012R	L0118TCTW00944
SIDE CAMERA	VCM012L	K0718TCTW0424
SLIDE ANNING 2	00	00
TOILET 2	8740	84897575
WIFI RANGER	11 990LTPACKATT	924808584CAP-817
WIFI DEYBOX	TUBS1202HMD	833947
WYDIO REAR	34900	CR80-34300-1128-9248
FRONT DVD	BDP-81700	2188484
REAR DVD	BDP-81700	2241058
FRONT CAP	BETTERWAY	
REAR CAP	BETTERWAY	
WIPER MOTOR	JUNE 2018	0424
WATER HOSE REEL	HUCK MASTER M	2018
OASIS DM-228	DM-12	37260-1128-9273
STL. ENTRY/EXIT DOOR	036611	096170
HOLDING TANK	AMER-KART	
FRESH TANK	AMER-KART	

Notices in Newgle and Newmar’s Owner’s Guide

Reference is made to the following terms throughout Newgle and the Owner’s Guide: Danger, Warning, Caution, Important, and Notice. These terms indicate important information that must be understood and followed.

Safety Definitions

⚠ DANGER

DANGER indicates an imminently hazardous situation that, if not avoided, will result in death or serious injury. Failure to observe a **DANGER** may also result in damage to the equipment or unit.

⚠ CAUTION

CAUTION indicates a potentially hazardous situation that, if not avoided, may result in minor or moderate injury. Failure to observe a **CAUTION** may also result in damage to the equipment or unit.

⚠ WARNING

WARNING indicates a potentially hazardous situation that, if not avoided, could result in death or serious injury. Failure to observe a **WARNING** may also result in damage to the equipment or unit.

⚠ IMPORTANT

IMPORTANT notices are not related to personal injury, but provide additional information to make a step easier or clearer.

NOTE FROM NEWMAR

NOTE FROM NEWMAR indicates helpful information to improve customer experience or satisfaction outside of what is provided by a component manufacturer or supplier.

⚠ NOTICE

NOTICE indicates information that is not necessary or required, but may prove to be helpful.

Newgle Introduction and Navigational Overview

This article provides a brief overview of Newgle: what it is, how to access it, how to navigate it, and what information is available. It also explains the different types of search filters that can be utilized in Newgle to produce the most effective search results.

What Is Newgle, and Why Do I Need It?

Do you have trouble finding reliable and trustworthy resources about your coach? How much time do you spend trying to figure out how to operate your appliances or what cleaning products are safe to use on your floors? What about troubleshooting information when something in your coach just is not working quite right? Do you prefer to find the answer yourself rather than asking for advice online or your neighbor parked next to you at the RV resort, or even contacting your dealer or customer service? You have come to the right place!

Welcome to the wonderful world of Newgle! Our free online knowledgebase provides you with coach information directly from Newmar, as well as our manufacturers and suppliers. Content is added and updated regularly and is only available to current coach owners and authorized service technicians. As part of Newmar’s seamless service promise, your questions can be answered quicker than ever before with just a few clicks on Newgle’s search-focused platform right from your laptop, tablet, or smartphone.

Newgle consists of nearly a dozen categories, hundreds of knowledge articles, and thousands of parts with associated coach models and years, files, and links. Finding coach information is no longer a headache or a chore – It is on Newgle!

Our goal is to provide you with the most updated information at all times. Though not coach-specific, Newgle supplies endless documentation about your coach model and year, all verified by Newmar’s Technical Publication department.

⚠ IMPORTANT

Newgle is an ever-changing knowledgebase. The Newgle Team strives to introduce new features and content regularly to improve the site. The included screenshots and navigational instructions may change without notice. Always refer to Newgle for the most up-to-date version of this content.

⚠ NOTICE

Any technical information published in Newgle is only intended for use by qualified, Newmar-authorized service technicians. Newmar is not responsible for misuse of this information.

How Do I Navigate The Website?

The Home Page is a launching pad into the endless sea of knowledge. You can easily return to the home page at any time by clicking the Newgle logo, the “Home” button at the top of the page, or by selecting the “Home” option from your username or nickname in the upper right-hand portion of the screen. There are three key ways to navigate our website: the Category Drop-Downs, Coach Filter, and Search Bar.



CATEGORY DROP-DOWNS

Navigate through Newgle using the drop downs at the top of the page: Category, Sub-Category, and Product Manufacturer Name. From here, select the model number of the component installed in your coach. This type of navigation provides a basic overview of the site structure, but does not associate products with any coach models or years.

SEARCH BAR

Search from the home page or from anywhere in the site using a key word or phrase, or by the product name, manufacturer, or model number. There is no need to search using coach information like the production number, VIN, model or year. Using the search bar produces the most results of the three different navigational options, which often contain one or more types of the following documentation:

- **Products (Parts) by year and model** - Specific components, items, and parts installed by Newmar, which can be refined by the coach model and year.
- **Files** - Attached documentation provided directly from Newmar’s product manufacturers, suppliers, vendors, and distributors. The file results often include owner’s guides, instruction manuals, installation guides, troubleshooting articles, care and maintenance guides, and much, much more. Files can be filtered on the left side of the screen by title and type of document.
- **Links** – Helpful web addresses of product manufacturers that often contain additional resources such as online warranty registrations, safety information, reference material, contact information, etc.
- **Knowledge articles** - Customer-friendly documentation written or revised by Newmar’s Technical Publications department. These may contain basic operating instructions, additional safety information, product overviews, how-to and troubleshooting articles, as well as related videos produced by Newmar. In the past few years, Newmar’s owner’s guides for each model have been built from such articles, as they are meant to be an operational overview for a new coach owner. Note: The model-year coach filter on the Home screen bypasses these articles unless they are associated with a specific product or part. To view a more complete list of these articles, use the search bar.

After typing a search term or phrase, relevant results will populate on the screen; however, this is often not a comprehensive list. Instead, it only provides a “preview” of the results. For a more exhaustive list, click on the “View More” button in the top right corner of the section you wish to expand. Click on the Show More button at the bottom of the page if you wish to view even more results.

With so many results, it may be necessary to narrow them down. Refine your search results by choosing one of the categories on the left side of the screen: Products by Year Model, Files, Links, or Knowledge Articles, depending on what type of documentation you prefer to view. For example, review parts associated to your coach model and year by clicking on the “Products by Year Model” tab. Then refine your results using the filters shown on the left side of the screen, such as year, model, product description, etc.

Once you find the part that you are looking for, click on the blue link to review the product page for that part. On this page, you will find helpful resources such as a picture (if it is available in Newmar’s online part’s catalog), the product description and features, as well as relevant files, links, and knowledge articles, for all of the documentation provided by Newmar and the part’s manufacturer or supplier.

EXAMPLES

How do I set the clock on my GE Advantium microwave and why does the time disappear from the display when I am not using it?

First, type in a simple search term such as “microwave.” Then, click on the “Products by Year Model” tab on the left side of the screen. Enter your coach year, followed by the model name or abbreviation (Dutch Star Diesel Pusher = DSDP). Click on the magnifying glass or press “Enter” or “Return” for each box. Easily clear one box at a time without erasing all of your search criteria. Note: If you do not know your model abbreviation, refer to the Newgle article titled “How do I find my coach model abbreviation for filtering?”

Select the microwave installed in your coach, and click on the related blue link (i.e. 125682P) to open the “GE Profile Advantium 1.7 Cu Ft 925w Stainless Steel Over-the-Range Microwave Oven” product page. On the product page, review the associated manufacturer’s links and files and select the best option that may answer your question. The user guide or manual often contains operation instructions, care and maintenance recommendations, and troubleshooting tips. The information about the clock is available in the “Other Features” portion of the GE Owner’s Manual.

A knowledge article also answers this question. Use a phrase such as “microwave clock” to locate an article about the GE microwave (PSA9120) containing this information. Scroll to the “Other Features” section of the article to read about the Clock settings. Whenever possible, Newmar provides text like this to answer your frequently asked questions quickly and efficiently.

How do I sanitize my coach’s fresh water system?

For this type of information, you want the Newmar-recommended procedures, rather than generic steps that may be available outside of Newgle. Simply type “sanitize” in the search bar. Results will show the files and links that may include information from product manufacturers, but they also produce knowledge articles. Click on the article about Sanitizing the Fresh Water System to view the step-by-step instructions for this procedure. But that’s not all! For this particular topic, you even have a video available for this topic provided by a Newmar Brand Specialist!

What If I Can’t Find What I’m Looking For?

Now that you know how to navigate, feel free to explore! Forget Google, and surf Newgle to answer your coach-related questions!

Just like the RV industry, our site is always growing, changing, and improving. Our dedicated, full-time Newgle staff is working diligently to provide you with access to more model- and year-specific information directly from the manufacturers as quickly as we can. Help us prioritize our efforts!

If you have suggestions for a better user experience, or if you are unable to locate the information you need, feel free to contact us:

- Email the Newgle team: newgle@newmarcorp.com
- Email the Customer Service team: customerservice@newmarcorp.com
- Call to speak to a Customer Service Brand Specialist: **1-800-731-8300** (option #2)

Newgle Registration and Login Assistance

This article provides information about registration and login assistance for Newgle, Newmar’s online knowledgebase.

How Do I Register For Newgle?

Visit Newgle at <https://newgle.newmarcorp.com> to register for an account.

CUSTOMER ACCOUNTS

If you own a Newmar coach, click the link associated with an owner account, “Coach Owner Account Request.” You will be asked to provide your coach information and some basic contact information, allowing the Newgle Team to verify ownership and set up an account just for you!

Once your account has been created, you will receive a verification email, which will include your new username and a link to create a password. The email address you provide when registering for an account will be used as your username, as well as for all Newgle-related communication, including account credentials, password resets, or any special updates from the Newgle team.

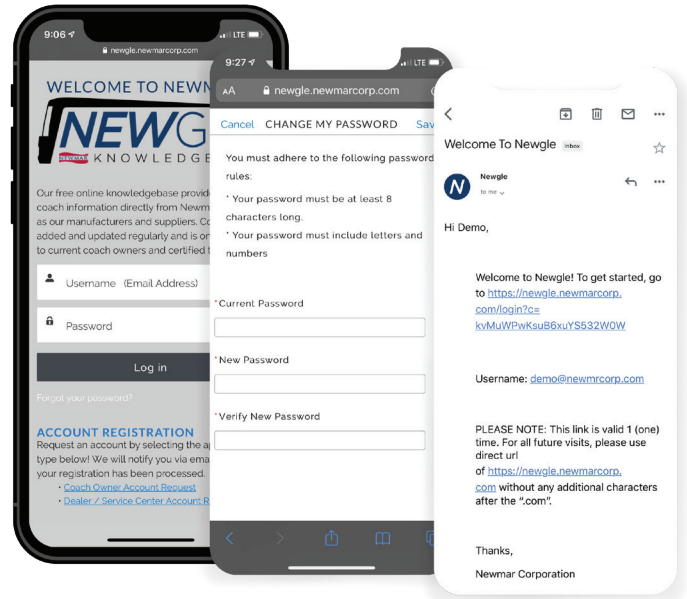

IMPORTANT

This link is only valid one time. Please use the direct URL - <http://newgle.newmarcorp.com> - for future access to the site.

If you already have a Newgle account but have since purchased a different coach, please request a new account to ensure that we have the most up-to-date information in our system. Your login credentials may or may not change pending the newly provided email address.

LOGOUT

End your Newgle session quickly with the click of a button.

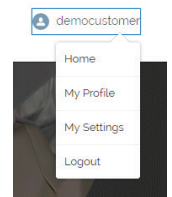

Having Trouble Logging In?

After three failed login attempts, your account will become locked for 15 minutes. Wait 15 minutes, and try to login again. If you forget or lose your password, or if it is no longer working, you can reset it at any time from the login screen.

Click on the “Forgot Your Password?” link, and enter your username (the email address you used when registering for your account), then click or tap “Continue.” You will receive an email with a link to reset your password. Remember, this link is only valid one time. Please use the direct URL - <https://newgle.newmarcorp.com> - for future access to the site.

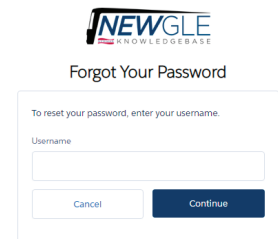

IMPORTANT

You will be asked to change your password every 180 days to ensure the highest level of security available. A new password cannot match any of the previously-used three passwords. When prompted, follow the onscreen instructions to create a new password that meets all of the requirements.

IMPORTANT

Your Newgle account may be deactivated after six months of inactivity. Newmar will provide notice prior to deactivation using the email address displayed in your profile.

If you have any questions regarding your account, or if you wish to re-activate your Newgle account, please email the Newgle Team at newgle@newmarcorp.com.

Contacting Newmar

This article provides contact information for the Customer Service, Parts, Sales, Newgle, and NewPro departments at Newmar.

Before You Reach Out To Us...

We have built a large pool of online tools and content to help RV'ers and Newmar customers alike. Explore Newgle and see if there's a resource to help solve your concern.

Customer Service

If you would like to speak to a Newmar Customer Service Representative, please call **1-800-731-8300** (option #2) or email customerservice@newmarcorp.com. For more information, visit the Parts and Support page on Newmar's website.

If you wish to schedule maintenance work, schedule service work, or order parts you should notify your local authorized Newmar Service Center to set up an appointment. If you are unsure of the location of the closest authorized Service Center, contact Newmar Customer Service.

Mountain Aire	
Phone:	966-540-9596
Email:	mountainaireservice@newmarcorp.com

Parts

For parts inquiries, refer to the NewPar (formerly ComNet) parts catalog or contact the parts department at **1-800-731-8300** (option #1).

Newgle

For questions pertaining to the Newgle knowledgebase, email newgle@newmarcorp.com. For coach-specific information or inquiries, please contact Customer Service.

Sales (Factory Tour)

To find out details about the Newmar factory tours, or to contact the Newmar Sales department, call **1-800-852-1731** or visit the Factory Tour page on Newmar's website.

Shipping/Mailing Address

Newmar Corporation
355 N Delaware Street
PO Box 30
Nappanee, IN 46550-0030



WHEN YOU KNOW THE DIFFERENCE.™





SAFETY

This chapter provides information about Newmar's compliance requirements, placards and labels, and driving safety. It also includes details about emergency exits and installed safety components (smoke, propane, and carbon monoxide detectors).

IMPORTANT

Any of the following quick start instructions provided by Newmar should not take the place of the manufacturer's complete documentation. Refer to Newgle for more information about safety-related components offered for your coach's model year.

Safety Resources and Compliance Requirements

This article provides information about Newmar's safety and compliance requirements.

Resources

- Recreation Vehicle Safety and Education Foundation (RVSEF)
- Transport Canada (TC)
- National Highway Traffic Safety Administration (NHTSA)

Compliance Requirements

Newmar motorhomes meet or exceed compliance for the following agencies:

UNITED STATES

- Federal Motor Vehicle Safety Standards (FMVSS)
- Nebraska and Washington State Seals
- National Fire Protection Association (NFPA) 1192 through Recreation Vehicle Industry Association (RVIA)
- National Fire Protection Association (NFPA) 70 National Electrical Code
- Ford Qualified Vehicle Modifiers (QVM) (Ford Chassis Only)
- Carb Compliant Phase 2

CONTACTING NATIONAL HIGHWAY TRAFFIC SAFETY ADMINISTRATION (NHTSA)

Mailing Address:

NHTSA Headquarters
1200 New Jersey Avenue SE
West Building
Washington, DC 20590

Telephone:

800-424-9153 (Hearing-Impaired)
888-327-4236 (Toll free)

Online:

<https://www.nhtsa.gov/recalls>

IMPORTANT

If you believe that your vehicle has a significant defect which could cause a crash or could cause injury or death, inform the National Highway Traffic Safety Administration (NHTSA) or Transport Canada (TC), and Newmar Corporation immediately.

CANADA

- Canada Motor Vehicle Safety Standards (CMVSS)
- QAI Laboratories is Newmar's listing agent

CONTACTING TRANSPORT CANADA

Mailing Address:

Transport Canada - ASFAD
330 Sparks Street
Ottawa, ON K1A 0N5

Telephone:

819-994-3328 (Ottawa - Gatineau area or internationally)
800-333-0510 (Toll free)

Online:

<http://www.tc.gc.ca/recalls>

Adresse postale :

Transports Canada -ASFAD
330, rue Sparks
Ottawa (Ontario) K1A 0N5

Téléphone: 819-994-3328 (dans la région de Ottawa-Gatineau et à l'extérieur du pays)

Sans frais: 1-800-333-0510 (au Canada)

Internet:

<http://www.tc.gc.ca/rappels>

Placards and Labels

A variety of placards and labels are located throughout your coach. These are installed to aid in the operation of a component, or to warn of potential dangers while operating a specific appliance, accessory, or system.

⚠ IMPORTANT

Reading, understanding, and heeding all such labels and placards is critical to the safe, efficient use of your coach.

Driving Safety

Before Driving Away

Provides a brief list of procedures that will aid in your driving safety and extend the life of your coach.

⚠ WARNING

Prior to driving your vehicle, be sure you have read your entire owner's guide and that you understand your vehicle's equipment completely. Read and understand all of the instructions and precautions in this owner's guide and the chassis manufacturer owner's manual before operating your new coach.

Listed below are some safety precautions that must be adhered to while your coach is in motion. These precautions, as well as others that involve possible damage to equipment, are also listed in the appropriate areas in this manual.

There are various adjustments that need to be made prior to starting and moving the vehicle. Among them are the driver's seat, the tilt steering, and the exterior side view mirrors, as well as checking the rear view monitoring system. In addition, the following procedures will aid in your driving safety and extend your equipment's life.

- Windows, mirrors, and light lenses are to be clean and unobstructed.
- Tires should be checked for proper cold inflation pressure.
- Wheel lug nuts should be checked for proper tightness.
- Fluid levels, including engine oil, transmission fluid, coolant, power steering fluid, brake fluid, and windshield washer solvent, should be checked and filled, if necessary.
- Disconnect the unit from power. Store the sewer and water supply hoses, as well as shoreline power cords.
- Secure all cargo in the storage compartments in the event of a sudden stop.
- Verify that the step has retracted prior to engine ignition.
- Know the overall height of your coach to avoid overhead damage from low clearance bridges, overpasses, awnings, etc.

Dangerous Driving Conditions and Severe Weather Safety

This article provides safety tips to follow for driving in dangerous conditions or encountering severe weather while using the coach.

Always Stay Informed

Avoid weather-related surprises by checking the forecast each day.

- If severe weather is a possibility, check a local weather website or phone application frequently for updates in your area. The National Weather Service (<https://www.weather.gov/>) is a great resource to check local forecasts. It may also be a wise decision to invest in a weather radio to receive up-to-date forecasts directly from the NWS.
- Know where you are at all times. Knowing which county you are in will help you know what is coming and when.
- For any extended stays, find out where the storm warning systems and alarms are located. It may also be helpful to know the days and times when these are typically tested to avoid any unnecessary concern.

Prepare Ahead of Time

If poor weather is in the forecast, preparing ahead of time can save you a lot of hassle.

- Check the function of your windshield wipers, brake lights, and headlights. Make sure you have plenty of fuel and that your tire pressure is correct to avoid hydroplaning.
- In the event of snow, freezing rain, or ice, make sure your coach is properly winterized. If you do not have to travel, wait until the roads are clear before proceeding to your next stop.

WARNING

The cruise control is not to be operated on icy roads, extremely wet roads, winding roads, heavy traffic, or in any other traffic situation where a constant speed cannot be maintained.

WARNING

While driving on slippery surfaces, use care when accelerating or decelerating. Skidding and loss of vehicle control may be the result of abrupt changes in speed.

- If parked, try to avoid surrounding trees or power lines. Secure all loose belongings that could blow away. Bring them inside the RV or store them securely in a basement compartment before a storm hits to prevent physical damage to you or the RV.
- Retract all awnings to prevent wind and water damage.
- Find out where local storm shelters are and have an evacuation plan in place.
- Pack an emergency bag of necessities (i.e. medical supplies, important documents, cell phone chargers, water, non-perishable food, etc.).

Take Cover

Your coach can protect you from most severe weather, but it is not always the safest option.

- If straight line winds or the threat of tornado(s) are in the forecast, leave the RV, and find a local storm shelter.
- If you are driving and severe weather or a tornado pops up, park the RV in a safe location (not under a bridge or overpass), lay down away from windows, and cover your head.
- In the event of heavy rain or floodwaters, do not attempt to drive through water that is crossing a road. **TURN AROUND; DON'T DROWN.**

WARNING

Driving through water deep enough to wet the brakes may affect the stopping distance or cause the vehicle to pull to one side. If you have driven through deep water, check the brake operation in a safe area to be sure they have not been affected.

WARNING

Never operate a vehicle if a difference in braking efficiency is noticeable. Extreme terrain and adverse weather may affect the handling and/or performance of your vehicle.

- If there is a threat (even a small one) of severe weather, plan indoor activities in a safe, sheltered place. Be prepared; have a plan in place; and use good judgment.

Seat Belt Safety

This article provides information about the seat belts installed in the coach, including operation and care and maintenance instructions.

One of the most important safety features in your vehicle is the restraint system. Research has shown that seat belts save lives. And they can reduce the seriousness of injuries in a collision. Some of the worst injuries happen when people are thrown from the vehicle. Everyone in a motor vehicle needs to be buckled up at all times.

WARNING

It is extremely dangerous to ride in a cargo area, inside or outside of a vehicle. In a collision, people riding in these areas are more likely to be seriously injured or killed. Do not allow people to ride in any area of your vehicle that is not equipped with seats and seat belts. Be sure everyone in your vehicle is in a seat and is using a seat belt properly.

How To Operate Your Seat Belts and Restraint System

⚠ WARNING

If you wear your safety belt improperly, both the effectiveness and comfort will decrease.

LAP/SHOULDER COMBINATION RESTRAINTS

1. Enter the vehicle and close the door. Sit back, and adjust the seat.
2. The latch plate of the belt is above the back of your seat. Grasp the latch plate, and pull out the belt. Slide the latch plate up the webbing as far as necessary to make the belt go around your lap.
3. When the belt is long enough to fit, insert the latch plate into the buckle until you hear a “click.”
4. Position the lap belt across your thigh, below your abdomen. If you need the lap portion tighter, pull up a bit on the shoulder part. A snug belt reduces the risk of sliding under the belt in a collision. Position the shoulder belt on your chest so that it is comfortable and not resting on your neck. The retractor will withdraw any slack in the belt.
5. To release the belt, push the release button on the buckle.



⚠ NOTICE

Some shoulder belts can be adjusted upward or downward to help position the belt away from your neck. Push on the anchorage cover to release it, and then move it up or down to the position that serves you best.

⚠ IMPORTANT

Everyone in your vehicle needs to be buckled up at all times. Every state in the United States and all Canadian provinces require that small children ride in proper restraint systems. This is the law, and you can be prosecuted for ignoring it.

LAP BELT RESTRAINTS WITHOUT A SHOULDER HARNESS

⚠ WARNING

Always wear your seat belt when the vehicle is in operation.

1. Slide the latch up the webbing as far as necessary to make the belt go around your lap.
2. Insert the latch plate into the buckle until you hear a “click.”
3. Adjust and position the belt low and snug across your hips by removing the slack from the belt.
4. To release the belt, push the release button on the buckle.

There are different sizes and types of restraints for children from newborn to near-adult size children. Use the restraint that is correct for your child:

- The restraint must be appropriate for your child’s weight and height. Check the label on the restraint for this, too.
- Carefully follow the instructions that come with the restraint. If you install the restraint improperly, it may not work when you need it.
- Buckle the child into the restraint exactly as the manufacturer’s instructions have directed.

⚠ IMPORTANT

Each belt is intended to restrain only one person at a time. Do not put two people under one belt.

⚠ CAUTION

Never attempt to restrain a child in your lap using the lap belt around both you and the child. The child could be severely injured or killed in the event of a collision.

⚠ IMPORTANT

Seat belts are matched sets. Do not mix or use this belt or parts of this belt with other types of seat belts.

How To Maintain Your Seat Belts and Restraint System

Periodically examine your restraint equipment to be sure it functions correctly and to be sure there are no worn or broken components that either needs repair or replacement. Damaged parts must be replaced immediately. Do not disassemble or modify the system.

Restraint equipment must be replaced after an accident if they have been damaged. If there is any question regarding belt or retractor condition, replace the belt. It is a good idea to have your restraint system inspected during each periodic scheduled maintenance session. If the belts need cleaning, use a mild soap solution or lukewarm water. Do not remove the belts from the vehicle to wash them.

Fire Safety

This article provides information about the smoke detectors and fire extinguishers installed in the coach.

The possibility of fire exists in all areas of life, and the recreational lifestyle is no exception. Recreational vehicles are complex machines made up of many materials, some of which are flammable. Like most hazards, the possibility of fire can be minimized, if not totally eliminated by recognizing the danger and practicing common sense safety and maintenance habits. For safety reasons, your unit is furnished with both a fire extinguisher and a smoke alarm.

WARNING

A frayed or torn belt could rip apart in a collision and leave you with no protection. Inspect the belt system periodically, checking for cuts, frays, or loose parts. Damaged parts must be replaced immediately. Do not disassemble or modify the system. Seat belt assemblies must be replaced after an accident if they have been damaged (bent retractor, torn webbing, etc.)

WARNING

Do not bleach, dye or clean the belts with chemical solvents or abrasive cleaners. This may severely weaken the fabric. In a crash, they might not be able to provide adequate protection.

 WARNING

Test smoke alarm operation after vehicle has been in storage, before each trip, and at least once per week during use. Failure to do so can result in death or serious injury.

 AVERTISSEMENT

Vérifier l'avertisseur de fumée si le véhicule a été entreposé, avant chaque déplacement et au moins une fois par semaine en service. L'absence de vérification peut entraîner des blessures graves ou la mort.

DD-94

 DANGER

Vehicles and equipment powered by internal combustion engines and placed in recreational vehicles can cause carbon monoxide poisoning or asphyxiation, which could result in death or serious injury. The flammable liquids used to power these items can cause a fire or explosion, which can result in death or serious injury.

To reduce risk:

1. Do not ride in the vehicle storage area when vehicles are present.
2. Do not sleep in the vehicle storage area when vehicles are present.
3. Close doors and windows in walls of separation (if installed) when any vehicle is present.
4. Run fuel out of engines of stored vehicles after shutting off fuel at the tank.
5. Do not store, transport, or dispense fuel inside this vehicle.
6. Open the windows, openings, or air ventilation systems provided for venting the transportation area when vehicles are present.
7. Do not operate propane appliances, pilot lights, or electrical equipment when motorized vehicles are present.

DANGER

If a fire occurs in the vehicle, evacuate the vehicle as quickly and as safely as possible. Consider the cause and the severity of the fire and the risk involved before trying to extinguish it. If the fire is major or fuel fed, move away from and stand clear of the vehicle and wait for emergency assistance to arrive.

Smoke Detectors

The smoke detector installed in your coach is operated on a 9 volt battery. The smoke detector is mounted on the ceiling in the living area of the unit. Read the operating instructions for details on the testing and care for this important safety device.

Test the smoke detector after the unit has been in storage, before each trip, and at least once a week during use. Check your smoke detector for the manufacturer's expiration date. The battery needs to be tested periodically and replaced once a year and/or when the low battery signal sounds.

When cleaning the case on any of the detectors, use a damp cloth or paper towel. Do not spray cleaners or wax directly into the case as it may cause false alarms.

IMPORTANT

The detector should never be disabled because of nuisance or false alarm from cooking smoke or a dusty furnace. Ventilate the unit with fresh air and the alarm will shut off. Never disconnect or remove the battery from the smoke alarm.

Fire Extinguishers

The fire extinguisher is rated for Class B (grease, gasoline, diesel fuel, flammable liquids) and Class C (electrical) fires. These are the most common types of fires in vehicles. Fire extinguishers are mechanical, pressurized devices. Care must be exercised when they are handled.

The extinguisher should be inspected at least once a month. More frequent inspections may be required if the extinguisher is exposed to the weather or to possible tampering. Do not test the extinguisher by partially discharging, as it will cause a loss of pressure. Your fire extinguisher must be maintained as the operator's manual instructs for proper and safe operation.

Read the operator's manual and the instructions on the fire extinguisher. Be sure to know how and when to use the extinguisher and where it is located.

DANGER

Failure to comply could result in an increased risk of fire, explosion, asphyxiation, serious injury, or death.

BRK Smoke Detector Operation (Model: FG250RV)

This article provides basic operation instructions for a BRK smoke detector (Model: FG250RV).

If The Smoke Alarm Sounds

During an alarm, you will hear a loud, repeating horn pattern: 3 beeps, pause, 3 beeps, pause; and the Red LED will flash rapidly.

⚠ WARNING

If the unit alarms and you are not testing the unit, it is warning you of a potentially dangerous situation that requires your immediate attention. NEVER ignore any alarm. Ignoring the alarm may result in injury or death.

⚠ WARNING

Never remove the batteries from a battery operated Smoke Alarm to stop an unwanted alarm (caused by cooking smoke, etc.). Removing batteries disables the alarm so it cannot sense smoke, and removes your protection. Instead open a window or fan the smoke away from the unit. The alarm will reset automatically.

⚠ WARNING

If the unit alarms get everyone out of the house immediately.

Regular Maintenance

This unit has been designed to be as maintenance free as possible, but there are a few simple things you must do to keep it working properly.

- Test it at least once a week.
- Clean the Smoke Alarm at least once a month; gently vacuum the outside of the Smoke Alarm using your household vacuum's soft brush attachment. Test the Smoke Alarm. Never use water, cleaners or solvents since they may damage the unit.
- If the Smoke Alarm becomes contaminated by excessive dirt, dust and/or grime, and cannot be cleaned to avoid unwanted alarms, replace the unit immediately.
- Relocate the unit if it sounds frequent unwanted alarms. See "Locations to Avoid for Smoke Alarms" for details.
- When the battery becomes weak, the Smoke Alarm unit will "chirp" about once a minute (the low battery warning). This low battery warning should last 7 days, but you should replace the battery immediately to continue your protection. Note: If locking pin is engaged see "Locking Feature" section for unlocking instructions.

Weekly Testing

It is important to test this unit every week to make sure it is working properly. Using the test button is the recommended way to test this Smoke Alarm. Press and hold the test button on the cover of the unit until the alarm sounds (the unit may continue to alarm for a few seconds after you release the button). If it does not alarm, make sure the unit is receiving power and test it again. If it still does not alarm, replace it immediately. During testing you will hear a loud, repeating horn pattern: 3 beeps, pause, 3 beeps, pause; and the Red LED will flash rapidly.

⚠ WARNING

Never use an open flame of any kind to test this unit. You might accidentally damage or set fire to the unit or to your home. The built-in test switch accurately tests the unit's operation as required by Underwriters Laboratories, Inc. (UL).

⚠ WARNING

If the alarm ever fails to test properly, replace it immediately.

⚠ CAUTION

Do not stand close to the alarm when the horn is sounding. Exposure at close range may be harmful to your hearing. When testing, step away when horn starts sounding.

Replacing The Battery

Your Smoke Alarm requires one standard 9V battery. The following batteries are acceptable as replacements: Duracell #MN1604, Eveready (Energizer) #522. You may also use a Lithium battery like the Ultralife U9VL-J, U9VL-J-P for longer service life between battery changes. These batteries are available at many local retail stores.

To lock/unlock the cover to the base:

1. Using needle-nose pliers or a utility knife, detach locking pin from back of alarm base.
2. Insert locking pin into the slot located on the front of the alarm as shown in the diagram.
3. Remove pin to unlock and replace battery.

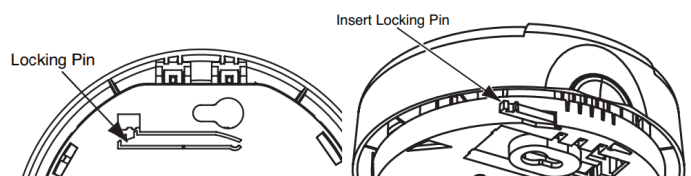

Source(s): BRK Battery Powered Smoke Alarm User's Manual

Product(s): BRK Electronics Smoke Detector (Model: FG250RV, Newmar Part Number: 119606)

Kidde 10 lbs. Fire Extinguisher UL Operation.

This article provides basic operation instructions for a Kidde fire extinguisher.

How To Use Fire Extinguishers

Stand 5 feet away from the fire and follow the four-step PASS procedure recommended by the National Fire Protection Association:

- **P** - Pull the pin and hold the extinguisher with the nozzle pointing away from you.
- **A** - Aim low at the base of the fire.
- **S** - Squeeze the lever slowly and evenly to discharge the extinguishing agent. When the agent first hits the fire, the fire may briefly flare up. This should be expected.
- **S** - Sweep the nozzle from side to side, moving carefully toward the fire. Keep the extinguisher aimed at the base of the fire.



Source(s): Kidde Fire Extinguisher Owner's Manual

When To Use Fire Extinguishers

It's important to remember that fire extinguishers are only one element of a complete fire survival plan. Only use your extinguisher after making sure:

- All residents of the home have been evacuated to safety
- The fire department has been notified
- There is a clear exit behind the person using the extinguisher

Use your extinguisher only to keep a small self-contained fire from growing, only when the room is not filled with smoke, or to create a safe pathway out of the home. Be sure to read the instructions and become familiar with your fire extinguisher's parts and operation before a fire breaks out.

Carbon Monoxide Safety

This article provides information about the safe use of carbon monoxide-producing coach components. Carbon monoxide is a colorless, tasteless, odorless gas. It is a by-product of the burning of fossil fuels (gasoline, propane gas, diesel fuel, etc.). The chassis and generator engines, furnaces, water heater, propane gas refrigerator, and range produce carbon monoxide constantly while they are operating.

Carbon Monoxide Poisoning

If you, or anyone else, experience any of the following carbon monoxide poisoning symptoms, exit the coach immediately. Seek medical attention if the symptoms persist. Shut down the coach, and do not operate it until it has been thoroughly inspected and repaired.

- Dizziness
- Nausea
- Vomiting
- Muscular twitching
- Throbbing in the temples
- Inability to think coherently
- Weakness and/or sleepiness
- Intense headaches

DANGER

Carbon monoxide is deadly. Read and understand the following precautions, as well as any warning labels in your coach, to protect yourself and others from the effects of carbon monoxide poisoning.

WARNING

Do not sleep in this area. Carbon monoxide or other harmful vapors could enter the area through the floor openings, which could result in death or serious injury.

AVERTISSEMENT

Ne pas dormir dans cette aire. Du monoxyde de carbone ou d'autres vapeurs nocives pourraient y pénétrer par des ouvertures dans le plancher et entraîner des blessures graves ou la mort.

DANGER

Vehicles and equipment powered by internal combustion engines and placed in recreational vehicles can cause carbon monoxide poisoning or asphyxiation, which could result in death or serious injury.

- To reduce risk:
1. Do not ride in the vehicle storage area when vehicles are present.
 2. Do not sleep in the vehicle storage area when vehicles are present.
 3. Close doors and windows in walls of separation (if installed) when any vehicle is present.
 4. Run fuel out of engines of stored vehicles after shutting off fuel at the tank.
 5. Do not store, transport, or dispense fuel inside this vehicle.
 6. Open the windows, openings, or air ventilation systems provided for venting the transportation area when vehicles are present.
 7. Do not operate propane appliances, pilot lights, or electrical equipment when motorized vehicles are present.

WARNING

Do not block the tailpipes or exhaust ports. Do not situate the vehicle in a place where the exhaust gases have any possibility of accumulating either outside, underneath, or inside your vehicle or any nearby vehicles. Outside air movements can carry exhaust gases inside the vehicle through windows or other openings remote from the exhaust outlet. Operate engines, carbon monoxide-producing systems, or components only when safe dispersion of exhaust gases can be assured. Monitor outside conditions to be sure that exhaust continues to be dispersed safely.

Carbon Monoxide (CO) Detectors

The detector is equipped with a “sensor activation strip,” which must be removed for the detector to operate properly. This should have been done during the dealer’s Pre-Delivery Inspection. Please check the detector to verify that the activation strip has been removed. The CO detectors are self-contained and do not require any maintenance other than normal cleaning and dusting.

Install battery or batteries into the battery holder, and observe the polarity. After approximately 30 seconds, the battery-operated detector will begin monitoring for carbon monoxide, making the device operational. The test/reset button is used to test the detector’s electronics and reset the detector after an alarm. Test the detector weekly.

⚠ WARNING

Under no circumstance should you operate any engine while sleeping. When you are sleeping, you are not able to monitor outside conditions to assure that engine exhaust does not enter into the coach. Check the exhaust system frequently for damage. If damage is found, do not operate the system. Never modify the exhaust system(s) in any way.

BRK (First Alert) Carbon Monoxide Alarm Operation (Model: CO250RVA)

This article provides basic operation instructions for a BRK (First Alert) carbon monoxide alarm (Model: CO250RVA).

How Your CO Alarm Works

A CO Alarm measures the CO levels in the air. It will alarm if CO levels rise quickly (if the heat exchanger on your furnace breaks, for example), or if CO is consistently present (a slow CO leak on a fuel-burning appliance).

This Carbon Monoxide alarm features a permanently installed sensor and an 85 dB alarm horn. It also has a silence feature to temporarily quiet the alarm horn.

If The CO Alarm Sounds

⚠ WARNING

Actuation of your CO Alarm indicates the presence of carbon monoxide (CO) which can kill you. In other words, when your CO Alarm sounds, you must not ignore it!

Welcome Chirp	Horn chirps and light blinks once when batteries are first connected.
Alarm Receiving Battery Power	Light flashes every minute. Horn is silent.
Low Battery Warning	The light continues to flash (RED) and the horn also "chirps" once every minute. This warning should last for up to 30 days, but you should replace the batteries as soon as possible.
During Testing	Light flashes RED with the horn pattern (4 beeps, pause, 4 beeps), simulating a CO Alarm condition.
CO Alarm	Sensor has detected enough CO to trigger an alarm. Light flashes rapidly and horn sounds loudly (repeating 4 beeps, pause). During an alarm, move everyone to a source of fresh air. DO NOT move the CO Alarm!
CO Alarm Requires Service (Malfunction Signal)	The light flashes (RED) and the horn sounds 3 "chirps" every minute. CO Alarm needs to be replaced.
CO Alarm Has Reached Its End of Life	The light flashes (RED) and the horn sounds 3 "chirps" every minute. CO Alarm needs to be replaced.

IF THE ALARM SIGNAL SOUNDS

1. If you hear the alarm horn and the Red light is flashing, move everyone to a source of fresh air. DO NOT disconnect the battery from the CO Alarm! Do a head count to check that all persons are accounted for. Do not re-enter the premises, or move away from the open door or window until the emergency services responder has arrived, the premises have been aired out, and your CO Alarm remains in its normal condition.
2. Call your emergency services, fire department or 911.
3. After following steps 1-2, if your CO Alarm reactivates within a 24-hour period, repeat steps 1-2 and call a qualified appliance technician to investigate for sources of CO from fuel-burning equipment and appliances, and inspect for proper operation of this equipment. If problems are identified during this inspection have the equipment serviced immediately.

Using The Silence Feature

WARNING

The Silence Feature is for your convenience only and will not correct a CO problem. Always check your home for a potential problem after any alarm. Failure to do so can result in injury or death.

WARNING

NEVER remove the batteries from your CO Alarm to silence the horn. Use the silence feature. Removing the batteries removes your protection!

The Silence Feature is intended to temporarily silence your CO Alarm's alarm horn while you correct the problem—it will not correct a CO problem. While the alarm is silenced it will continue to monitor the air for CO.

When CO reaches alarm levels the alarm will sound—repeating horn pattern: 4 beeps, a pause, 4 beeps, etc. Press and hold the Test/Silence button until the horn is silent. The initial Silence cycle will last approximately 4 minutes.

NOTE: After initial 4-minute Silence cycle, the CO Alarm re-evaluates present CO levels and responds accordingly. If CO levels remain potentially dangerous—or start rising higher—the horn will start sounding again.

WHEN THE DETECTOR IS SILENCED:

- IF the CO alarm is silent for only 4 minutes, then starts sounding loudly - 4 beeps, pause, 4 beeps, pause... THEN the CO levels are still potentially dangerous.
- IF the CO alarm remains silent after you pressed the Test/Silence button... THEN the CO levels are dropping.

SILENCING THE LOW BATTERY WARNING

This silence feature can temporarily quiet the low battery warning “chirp” for up to 8 hours. You can silence the low battery warning “chirp” by pressing the Test/Silence button. The horn will chirp, acknowledging that the low battery silence feature has been activated.

After 8 hours, the low battery “chirp” will resume. Replace the battery as soon as possible; this unit will not operate without battery power!

To deactivate this feature: Press the Test/Silence button again. The unit will go into Test Mode and the low battery warning will resume (LED flashes and unit sounds “chirp” once a minute.)

If you cannot silence the low battery warning, replace the battery immediately.

SILENCING THE END OF LIFE SIGNAL

This silence feature can temporarily quiet the End of Life warning “chirp” for up to 2 days. You can silence the End of Life warning “chirp” by pressing the Test/Silence button. The horn will chirp, acknowledging that the End of Life silence feature has been activated.

- After approximately 2 days, the End of Life “chirp” will resume.
- After approximately 2-3 weeks the End of Life warning cannot be silenced.

Testing and Maintenance

WEEKLY TESTING

WARNING

Test the CO Alarm once a week. If the CO Alarm ever fails to test correctly, have it replaced immediately! If the CO Alarm is not working properly, it cannot alert you to a problem.

WARNING

Do NOT stand close to the Alarm when the horn is sounding. Exposure at close range may be harmful to your hearing. When testing, step away when horn starts sounding.

Push and hold the Test/Silence button on the cover until the LED flashes. The alarm horn will sound 4 beeps, a pause, then 4 beeps. The ALARM (RED) light will flash.

The alarm sequence should last 5-6 seconds. If it does not alarm, make sure fresh batteries are correctly installed, and test it again. If the unit still does not alarm, replace it immediately.

IF THE ALARM DOES NOT TEST PROPERLY:

1. Make sure the battery is installed correctly.
2. Be sure the Alarm is clean and dust-free.
3. Install a fresh 9V battery and test the Alarm again.

WARNING

DO NOT try fixing the Alarm yourself - this will void your warranty! Install a new CO Alarm immediately.

WARNING

The Test/Silence button is the only proper way to test the CO Alarm. NEVER use vehicle exhaust! Exhaust may cause permanent damage and voids your warranty.

REGULAR MAINTENANCE

To keep the CO Alarm in good working order:

- Test it every week using the Test/Silence button.
- Vacuum the CO Alarm cover once a month, using the soft brush attachment. Never use water, cleaners, or solvents, since these may damage the unit. Test the CO Alarm again after vacuuming.
- Replace the batteries when the CO Alarm “chirps” about every minute (the low battery warning). The low battery warning should last for 30 days, but you should replace the battery immediately to continue your protection.

CHOOSING A REPLACEMENT BATTERY:

This CO Alarm requires one 9V alkaline battery. The following batteries are acceptable as replacements: Alkaline Batteries — Duracell MN1604 or Energizer 522; Lithium Batteries — Ultralife U9VL-J. These replacement batteries are commonly available at local retail stores.

Propane Safety

This article provides details about the propane fuel system in a Newmar coach, including propane safety and maintenance.

Your coach may be equipped with an ASME (American Society of Mechanical Engineers) approved propane tank. This tank is controlled with an automatic pressure regulator. The propane tank contains liquid petroleum gas under high pressure. As the fuel is used, the liquid gas vaporizes and passes through the tank valve to a regulator that automatically reduces the pressure. The low-pressure gas is then distributed to the appliances throughout the pipe manifold system.

The components relating to the propane gas system in your coach have been approved for use in recreational vehicles by a nationally recognized testing laboratory. Propane gas is a clean-burning dependable fuel when properly handled.

⚠️ IMPORTANT

While in high altitudes or extreme cold weather, a gas shortage may be experienced. Running one appliance at a time can help adjust to this problem.

⚠️ DANGER

Exhaust gases contain carbon monoxide (an odorless, colorless, and poisonous gas) produced by burned gasoline, diesel, or propane gas. Items such as the range, furnace, water heater, refrigerator, chassis engine, or generator engine can produce these gases. These fumes should not be inhaled.

⚠️ WARNING

Always use the exact batteries specified by this User’s Manual. DO NOT use rechargeable batteries. For products requiring multiple batteries, replace all batteries of a set at the same time. Do Not Mix Old and New Batteries. Clean the battery contacts and also those of the device prior to battery installation. Install batteries correctly with regard to polarity (+ and -).

⚠️ WARNING

Please dispose of or recycle used batteries properly, following any local regulations. Consult your local waste management authority or recycling organization to find an electronics recycling facility in your area. DO NOT DISPOSE OF BATTERIES IN FIRE. BATTERIES MAY EXPLODE OR LEAK.

Source(s): BRK Battery Powered Carbon Monoxide Alarm (CO250RVA-48B) User’s Manual

Product(s): BRK Electronics Carbon Monoxide Alarm (Model: CO250RVA, Newmar Part Number: 125654)

Propane Safety

⚠️ WARNING

Portable fuel-burning equipment, including wood and charcoal grills and stoves, shall not be used inside the coach, as they can cause fire or asphyxiation. Failure to comply could result in serious injury or death.

PROPANE (LP) DETECTOR

The propane detector in your coach is located in the main living area close to the floor. It is wired to the 12 volt electrical system in your unit and may be controlled by a switch in the front overhead cabinet. Operating instructions and a test button are located on the face of the detector. The propane detector should be tested after the vehicle has been in storage, before each trip, and at least once per week during use.

Never attempt to repair the propane detector. Do not remove the fuse or disconnect wiring to the propane detector. If the propane detector will not function, check for 12 volt power at the detector. If an issue is found, or if the 12 volt electric circuit not operational, repair the 12 volt issue or replace the propane detector.

⚠️ WARNING

Do not use coach with a non-operational LP detector.

Never spray any type of aerosol or cleaner directly onto or into the propane detector. Spraying any type of material into the opening on any of these detectors can render them useless, and would not be covered by the manufacturer's warranty.

Refer to Newgle for more information about your coach's propane (LP) gas detector.

PROPANE WARNING LABELS

IMPORTANT

Read and understand the following precautions, as well as any warning labels in your coach, to protect yourself and others from the risks of operating an LP system.

The following labels regarding propane safety are strategically placed inside of your coach.

<p>⚠ WARNING</p> <p>This propane piping system is designed for use with propane only. Do not connect natural gas to this system. Securely cap inlet when not connected for use. After turning on propane, except after normal cylinder replacement, test propane piping and connections to appliances for leakage with soapy water or bubble solution. Do not use products that contain ammonia or chlorine to test for leaks. May lead to a fire or explosion which could result in death or serious injury.</p>	<p>⚠ AVERTISSEMENT</p> <p>Cette tuyauterie de propane est conçue pour n'être utilisée qu'avec du propane. Ne pas l'utiliser pour du gaz naturel. Bien capuchonner l'entrée de la tuyauterie lorsque elle n'est pas raccordée. Après avoir ouvert la vanne du propane, sauf lors du remplacement normal du cylindre, faire un essai d'étanchéité de la tuyauterie de propane et des raccords aux appareils à l'aide d'eau savonneuse ou d'une solution qui produit des bulles. Ne pas effectuer d'essai d'étanchéité à l'aide d'ammoniac ou de chlore. Le non-respect de cette instruction peut causer un incendie ou une explosion, ce qui pourrait entraîner des blessures graves ou la mort.</p>	<p>⚠ CAUTION</p> <p>Shut off gas supply before disconnecting appliance.</p>
		<p>⚠ ATTENTION</p> <p>Couper le gaz avant de déconnecter l'appareil.</p>

IF YOU SUSPECT A GAS LEAK

If the detector alarms while in use, or if you smell propane or suspect a gas leak (the odor smells similar to rotten eggs or sulfur), follow the warning labels in your coach.

DANGER

Never test for a leak by lighting a match or having an open flame where you suspect leaking gas.

- Immediately turn off all potential sources of ignition (furnace, water heater, refrigerator, stove/range, etc.), and extinguish any open flames, pilot lights, and all smoking materials.
- Do not touch electrical switches.
- Shut off the propane supply at the container valve(s) or propane supply connection.
- Open doors and other ventilating openings.
- Evacuate the unit, and leave the area until the odor clears.
- Consult an authorized service technician for repairs, as the propane system must be checked and leakage source corrected before using again.

<p>⚠ DANGER</p> <p>IF YOU SMELL PROPANE</p> <ol style="list-style-type: none"> 1. Extinguish any open flames and all smoking materials. 2. Shut off the propane supply at the container valve(s) or propane supply connection. 3. Do not touch electrical switches. 4. Open doors and other ventilating openings. 5. Leave the area until the odor clears. 6. Have the propane system checked and leakage source corrected before using again. <p><small>IGNITION OF FLAMMABLE VAPORS COULD LEAD TO A FIRE OR EXPLOSION AND RESULT IN DEATH OR SERIOUS INJURY.</small></p>	<p>⚠ DANGER</p> <p>SI VOUS SENTEZ UNE ODEUR DE PROPANE :</p> <ol style="list-style-type: none"> 1. Éteignez toute flamme nue et tout article pour fumeur. 2. Coupez l'alimentation en gaz de l'appareil au réservoir ou au raccordement d'alimentation. 3. Ne touchez pas aux interrupteurs électriques. 4. Ouvrez les portes et toute autre ouverture de ventilation. 5. Quittez les lieux jusqu'à ce que l'odeur ait disparu. 6. Faites vérifier l'installation et colmater toute fuite avant d'utiliser de nouveau. <p><small>L'INFLAMMATION DES VAPEURS INFLAMMABLES POURRAIT PROVOQUER UN INCENDIE OU UNE EXPLOSION ET ENTRAÎNER DES BLESSURES GRAVES OU LA MORT.</small></p>
--	--

Propane Operation

Check the LP level either from the monitor panel in the coach or the gauge on the LP tank to ensure an adequate fuel level.

Make sure the LP valve is open. To open it, turn the valve counterclockwise.

When having the tank filled, or if the coach is in storage, or if LP is not currently needed, turn off the gas at the LP tank by turning the valve clockwise.

The tank fill valve and the 80% bleeder valve should not be tampered with by the user. These valves are for filling purposes and should only be performed at a licensed filling station.

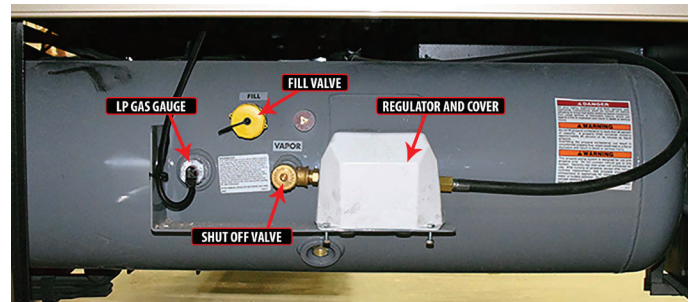

Propane System Maintenance

It is recommended to have the propane system inspected by an authorized service technician at least once a year and after every extended trip. This system is tested by both the manufacturer and the dealer; however, leaks may be caused by travel vibrations.

FILLING THE PROPANE SYSTEM

Tank filling should only be performed by trained professionals. Prior to filling the propane tank, turn off all flame or spark-producing appliances, extinguish any smoking items, and turn off the coach engine.

WARNING

Inspect the propane fill valve for foreign materials before refueling. Introducing foreign material into the fill valve may cause leaking or overfilling, resulting in uncontrolled gas flow and a fire or explosion.

WARNING

While refilling the fuel or propane tank, the engine must be off, all pilot lights must be extinguished, and appliances turned off. The vehicle should be as level as possible, and the service valve should be turned off. Smoking is also prohibited at this time.

⚠ WARNING

Shut off the propane gas valve when refueling to avoid potential danger from pilot lights igniting fuel fumes. Some appliances, such as the refrigerator, water heater, and furnace, have DSI (direct spark ignition) boards, so it is important that you turn the appliances off when the propane gas is turned off. The ignition in the appliances may continue to spark even if there is no propane gas available.

⚠ IMPORTANT

All protective covers and caps must be replaced after filling the propane system. Once the valve is closed, securely latch the propane door.

⚠ WARNING

Propane gas is extremely flammable. Propane gas containers, gasoline, or other flammable liquids shall not be placed or stored inside the vehicle. Propane cylinders are equipped with safety devices that relieve excessive pressure by discharging propane to the atmosphere. Failure to comply could result in serious injury or death.

⚠ WARNING

Do not fill propane container(s) to more than 80 percent capacity. Overfilling the propane container can result in uncontrolled propane flow, which can cause fire or explosion. A properly filled container contains approximately 80 percent of its volume as liquid propane. Failure to comply could result in serious injury or death.

⚠ WARNING

Do not fill propane container(s) to more than 80 percent of capacity. A properly filled container contains approximately 80 percent of its volume as liquid propane. Overfilling the propane container(s) can result in uncontrolled propane flow, which could lead to a fire or explosion and result in death or serious injury.

⚠ WARNING

This propane piping system is designed for use with propane only. Do not connect natural gas to this system. Securely cap inlet when not connected for use. After turning on propane, except after normal cylinder replacement, test propane piping and connections to appliances for leakage with soapy water or bubble solution. Do not use products that contain ammonia or chlorine to test for leaks. May lead to a fire or explosion, which could result in death or serious injury.

⚠ AVERTISSEMENT

Ne pas remplir les bouteilles de propane à plus de 80 % de leur capacité. Une bouteille remplie de manière appropriée est remplie de propane liquide à environ 80 pour cent de son volume. Un remplissage excessif peut entraîner un écoulement incontrôlé du propane, ce qui pourrait provoquer un incendie ou une explosion et causer des blessures graves ou la mort.

⚠ AVERTISSEMENT

Cette tuyauterie de propane est conçue pour le propane uniquement. Ne pas raccorder de gaz naturel à cette tuyauterie. Obturer l'orifice d'entrée lorsque le réservoir n'est pas utilisé. Une fois le robinet d'alimentation ouvert, sauf après un remplacement normal de la bouteille, vérifier l'étanchéité de la tuyauterie et des raccords avec une eau savonneuse ou autre solution faisant des bulles. Ne pas utiliser de produits contenant de l'ammoniac ou du chlore pour les essais d'étanchéité. Peut provoquer un incendie ou une explosion et causer des blessures graves ou la mort.

CO-251

⚠ WARNING

When removing or servicing any gas appliance, close the main gas valve on the propane tank to prevent dangerous gas leakage that could result in an explosion and possible serious injury. If a gas leak is suspected, have the system inspected and repaired by a qualified service technician as soon as possible.

STORING A PROPANE-EQUIPPED COACH

Keep the tank valve closed and all of the appliances turned off when the unit is stored. If any of the Propane gas valves do not close leak-tight by hand, consult a service technician.

On older coaches, an LP switch may be located in the front overhead or toward the bottom of the passenger chair. This switch shuts off power to the propane detector to prevent an unnecessary draw from the battery bank while the coach is in storage.

Newer coaches are wired to the disconnect side of the battery disconnect solenoid to prevent the detector from draining the battery while the coach is in storage with the disconnect turned off. Keep this switch turned on when the coach is in use for the capability of detecting a leak in the propane system.

⚠ CAUTION

Shut off the main gas valve at the tank when the vehicle is not in use.

SERVICING THE GAS DISTRIBUTION LINES

The primary gas supply manifold is a black steel pipe running the length of the unit. Most secondary lines leading to the gas appliances are made of copper tubing with flare fittings.

⚠ WARNING

If any of these lines rupture, do not attempt to splice them. Always run a new line. Gas distribution work must be performed by an authorized service technician.

RV Safe 12 Volt Propane Leak Detector Operation (Model: RVLP-2B)

This article provides basic operation instructions for a RV Safe 12 Volt Propane Leak Detector (Model: RVLP-2B).

Understanding The Dangers of Propane Gas

Liquefied petroleum (LP) gas is commonly called propane and is used as fuel for heating and cooking appliances, especially for RV's. Propane gas is explosive at the lower-explosive-limit (LEL), which is 21,000 parts per million (ppm). RV Safe will alarm at 10% LEL, or 2,100 ppm.

Propane gas is denser than air, and will usually accumulate close to the floor. Therefore, RV Safe should be placed near the floor in order to quickly detect propane gas leaks.

Alarm Features and Functions

RV Safe includes an 85dB audible horn, two LEDs, and a Silence/Test button. The chart below summarizes the alarm outputs in each state.

State	Green LED	Red LED	Audible Horn
Normal Operation	ON	OFF	OFF
Power Off	OFF	OFF	OFF
Self Test	OFF	ON/Flashing	4 Chirps constant beeps
Propane Alarm	OFF	ON	Constant beeps
Alarm Silenced (5 Minutes Max.)	OFF	Flash each second	OFF
Low Battery	Flash each minute	Flash each minute	Chirp each minute
End-of-Life or Other Failure	OFF	Double flash each minute	Chirp each minute



NORMAL OPERATION STATE

The green power LED is ON when the alarm is functioning normally and no CO or propane gas is present. Press the Silence/Test button to perform a self test and enter the Test State. Note: Supply current will remain higher for 30 seconds after power-up. Alarm will not detect CO or Propane for the first 30 seconds and will draw extra current.

POWER OFF STATE

If no LEDs are on, then the alarm is powered off. Apply power to the alarm to resume normal operation.

SELF TEST STATE

If the Silence/Test button is pressed while in normal operation, the alarm will perform a self test of the CO sensor, propane sensor and battery voltage. It is recommended to perform a self test weekly, after power up from storage, and before each trip. If the self test passes, the alarm will perform 2 cycles of the CO horn pattern (4 rapid chirps followed by a 4 second pause), followed by 2 cycles of the propane horn pattern (constantly beeping).

PROPANE ALARM STATE

If propane gas exceeds 10% of the lower-explosive-limit for more than 30 seconds, the alarm will enter propane alarm state. The horn will sound with constant beeps and the red LED will be on. Immediately turn off all propane appliances and gas valve at the propane tanks. Open doors and windows to properly ventilate the RV. Check for any gas leaks and contact a qualified RV technician to diagnose possible propane leaks. The alarm may be silence for 5 minutes by pressing the Silence/Test button.

ALARM SILENCE STATE

A CO alarm or propane alarm can be silenced for up to 5 minutes by pressing the Silence/Test button. The red LED will flash each second while the alarm is silenced. The original alarm state will resume after 5 minutes if the CO or propane levels still exceed safe levels.

LOW BATTERY STATE

If the supply voltage drops below 8VDC, the alarm will enter Low Battery State. The horn will chirp every minute and both LEDs will flash every minute. Alarm performance cannot be guaranteed as the supply voltage drops below the low battery threshold. Charge or replace the RV battery immediately. Do NOT disconnect the alarm.

END-OF-LIFE OR OTHER FAILURE STATE

If the CO or propane alarm fails a self test, or if the End-of-Life is reached (after 5 years of operation), the alarm will enter the Failure State. The horn will chirp every minute and both LEDs will do a double flash every minute. Replace the alarm immediately.

Maintaining Your Alarm

- Verify proper alarm function by pressing the Silence/Test button after storage, before every use and once per week during extended use.
- Vacuum the alarm with a soft brush attachment to remove dust monthly.

Source(s): RV Safe Propane Gas Alarm (RVLP-2 and RVLP-3) for RVs Owner's Manual

Product(s): RV Safe Alarm 12V Propane Detector (Model: RVLP-2B, Newmar Part Number: 152865)

Emergency Exits

This article provides step-by-step instructions for opening and closing emergency exit windows and doors.

How to Open and Close the Emergency Exit Windows

This article provides step-by-step instructions for opening and closing emergency exit windows.

Hehr Egress Emergency Exit Window

Select Hehr windows have an opening window pane in the egress window for ventilation. This style of window can also be opened in the event of an emergency.



TO OPEN THE VENT:

1. Unclip and lower the arm.
2. Swing the arm 90 degrees, and push out on the arm until the red handle latches.

TO CLOSE THE VENT:

1. Unclip the red handle from the latch by lifting slightly while pushing outward.
2. Once the latch releases, pull the arm in until the window is closed.
3. Rotate the arm 90 degrees until it latches into the closed position.



IN THE EVENT OF AN EMERGENCY, OPEN THE WINDOW:

1. Remove the screen by pulling out on the red handle.
2. Push and release the lever from the locking hook.
3. Rotate the lever 90 degrees, and push it through the slot in the window frame.
4. Escape through the opening.

Hehr Double-Latched Emergency Exit Window

TO OPEN THE EMERGENCY EXIT DOUBLE LATCH STYLE WINDOW:

1. Flip both latches up to the open position.
2. Push out on the window.



TO CLOSE AND LATCH THE EMERGENCY EXIT DOUBLE LATCH STYLE WINDOW:

1. Pull the window shut while holding the window track with one hand.
2. With the other hand, rotate the latch up until it connects with the track on the window.
3. Press the front side down until it latches.
4. Repeat the steps for the second latch.

How to Operate the Emergency Egress Exit Door and Ladder

This article provides the Newmar-recommended step-by-step instructions for operating the emergency exit door and ladder.

NOTICE

The emergency egress exit door and ladder is a feature only installed on some coach floor plans.

Emergency Egress Exit Door and Ladder

TO USE THE EMERGENCY EGRESS EXIT DOOR:

1. Unlock the deadbolt by turning it in a counterclockwise motion.
2. Make sure the door latch is unlocked.
3. Unlatch and completely open the door to avoid coach damage during ladder extension.



4. Grab and pull the tab to remove the ladder cover, and set it aside.
5. Grab and pull the tab on the Velcro strap to release the ladder.
6. Flip the ladder out, allowing it to extend to the ground.



TO CLOSE THE EMERGENCY EXIT DOOR:

1. Lift the ladder from the bottom, stacking the rungs and pushing the ladder up into the door cavity.
2. Secure it in place with the Velcro strap.
3. Reinstall the ladder cover.
4. Close and latch the door.
5. Lock the door latch by sliding it into the locked position.
6. Lock the deadbolt by turning the deadbolt in a clockwise motion.

This page is intentionally blank.



APPLIANCES

This chapter provides information regarding each appliance available for your coach model and year, including cooktops and ranges, dishwashers, fireplaces, microwaves and convection ovens, refrigerators and freezers, central vacuum systems, and washers and dryers.

⚠ IMPORTANT

Any of the following quick start instructions provided by Newmar should not take the place of the manufacturer's complete documentation. Refer to Newgle for more information about appliances offered for your coach's model year.

Before Scheduling Service Work For Your Appliance

This article provides helpful tips to follow prior to scheduling service work for your coach appliances.

⚠ IMPORTANT

Most appliance manufacturers (i.e. Whirlpool, GE, Maytag, Samsung, Fisher Paykel) require that service work performed on their appliances be completed by one of their own authorized service technicians. However, most appliance service technicians will not remove any appliance from its secured location if it is installed inside an RV. Instead, most require the appliance to be removed from its secured location prior to completing any service work.



Complete the following steps prior to scheduling any appliance servicing, repairs, or replacement, as this requires the coordination of multiple parties to complete the repair.

Note: It is recommended that you contact the appliance manufacturer right away so they can note the account/issue. They may also assist with locating an authorized service technician near your location.

In order to service an appliance in your coach, select one of the following options:

Option 1

1. Take the coach to your dealer, who can coordinate an appointment with a local manufacturer-specific appliance service technician to come on-site to make the repair.
2. In the meantime, one of the dealer technicians will remove the appliance from its mounted position so that the manufacturer-specific technician can service it.
3. Once repairs are complete on the appliance, the dealer technician will reinstall the appliance in its mounted position.

Option 2

1. Set an appointment with a local manufacturer-specific service technician.
2. Contact a local mobile technician to come to your location to remove the appliance prior to the appointment with a manufacturer-specific appliance technician.
3. Once the mobile technician has removed the appliance, the manufacturer-specific technician can then service the appliance.
4. After repairs are made, contact the mobile technician to come back to the coach and reinstall the appliance.

Option 3

1. Set an appointment with a local manufacturer-specific appliance service technician.
2. Remove your own appliance from its mounted position. Some instructions may be obtained on Newgle or by contacting Newmar Customer Service at 1-800-731-8300.
3. Once the manufacturer-specific technician has serviced the appliance, reinstall it by reversing the procedure for removing it from its mounted position.



Cooktops and Ranges

Style and function meet for a home cooked meal any night of the week, all at your fingertips. Newmar offers several styles and brands of ranges and cooktops for your coach. Whether a gourmet or beginner chef, your cooktop or range will provide you with all of the necessities - and wants - you desire and deserve to prepare meals for you and your family.

Single or Double Solid Surface Cooktop Cover Overview

This article provides an overview of the solid surface cover for the range or cooktop. This cover may be made up of one or two solid surface pieces.

Your range may be equipped with a solid surface cover that matches your countertop material. This cover helps to protect the burners when they are not in use. Before cooking on the range top, the cover must be removed and stored during cooking.

Some coaches with an induction cooktop may have a solid surface cover with a built-in cutting board.



⚠ IMPORTANT

Never close the cover while the burners are in use. Never use the range while the RV is moving and remember to reinstall the solid surface cover when the range top is not in use.

True Induction 2-Burner Induction Cooktop Operation (Model: TI-2B / S2F3)

This article provides basic operation instructions for a True Induction 2-Burner Induction Cooktop (Model: TI-2B / S2F3).

The counter inset model of the Double Burner Induction Cooktop is not only energy efficient and safe. It also features a sleek glass-ceramic top that fits directly into your counter, maximizing the amount of space that you have to work with. Space is important, especially in an RV. You don't have to worry about losing counter space or storage because the cooktop is nothing more than a flat surface.

⚠ NOTICE

Induction cooktops require pots and pans that are made of ferrous (meaning magnetic) materials. The following are not compatible: heat-resistant glass, ceramic, copper, aluminum pan/pots, round-bottomed cookware, or cookware with a base less than 4.5 inches.

How To Use

Unlike standard stove tops that generate and displace heat in a way that wastes energy and runs the risk of causing injury or being a fire hazard, the counter inset induction cooktop generates heat through a magnetic circuit that connects with ferromagnetic cookware, allowing the heat to be generated by the pot or pan being used. The True Induction cooktop is also easy to use.

1. Plug the power plug into a standard outlet.
2. The Power button will light up and the unit will sound to indicate on.
3. The device will remain in standby mode, awaiting user direction.
4. Place ferromagnetic cookware (with water, oil or food already inside) on the center of the glass-ceramic top center.
5. Now press the Power button on the control panel, this will turn the cooktop on. The power display will blink and sound another indicator.
6. Press the Heat function key once. The pre-set power level "5" is the default selection as the device turns on.
7. Using the +/- keys you can change the settings at any time, ranging from 1-10. This is considered to be the HEAT function.

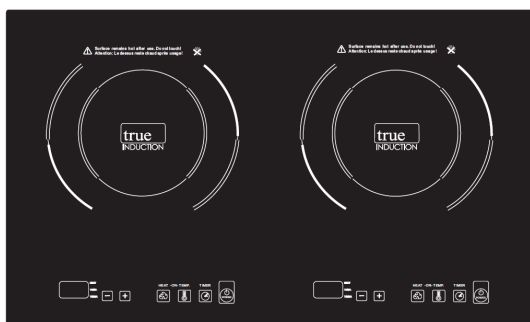

⚠ CAUTION

Do not place induction cookware on the cooktop burner until operation of cooktop is desired.

Power Invariance Technology

The maximum power of an individual burner level is at setting 10. But, when operating both burners their combined total is level 10, meaning that when operating the two burners at the same time they'll self adjust levels accordingly:

- When you increase the power of one side, the power output of the other side will reduce automatically (i.e., one side is at 6, the other burner automatically reduces power to level 4 creating a total of max 10 setting).
- If one side of the double burner is using the HEAT function and the other side uses the TEMP settings, the maximum HEAT setting is "5."

Using The Timer Function

- After selecting the HEAT or TEMP mode, press the TIMER button once. The display will show the number "0." Using the +/- keys you can select the operating time in 5-minute intervals (up to max 150 min.) and reducing 1 minute.
- The display will count down the duration in minutes. Once the time is up, the unit sounds and automatically goes into standby mode. To continue cooking, press the Power button and Heat button to restart.
- During the timer operation, you can change the timer duration at any time with the arrow keys. The device's built-in memory maintains the HEAT or TEMP setting previously entered.
- You can also change the HEAT or TEMP settings without affecting the current timer setting.

Using The Temperature Setting

Using the +/- keys you can change the temperature settings at any time. Settings range from 150-450 degrees Fahrenheit. (Exact temperatures: 150, 180, 210, 240, 270, 300, 330, 360, 390, 420 and 450 F).

Built-In Safety Shut Off

- The True Induction cooktop is designed to automatically shut off after 150 minutes of use. This built-in auto shut off is a safety feature.
- This function occurs for both the HEAT and TEMP settings. The panel displays EE code and sounds indicating this auto-off setting.
- In the event your food requires further cooking, the unit can easily be turned back on and re-set to the desired setting.

Turning Off Unit

- When you are finished cooking, simply press the Power button to turn off the machine.
- Upon completion of cooking, the fan may remain on until the unit is cool.

The power light indicators turn on and the unit will immediately begin heating if proper ferromagnetic cookware is used. There are two main heat settings, a quick touch level selection featuring settings 1-10 and an exact temperature setting ranging from 150 to 450 degrees Fahrenheit. The default heat setting is level 5 and the settings can be adjusted by pressing the "+/-" key to achieve the desired heat. The default temperature setting is 270 degrees Fahrenheit and the temperature can be adjusted in 30-degree increments.

Source(s): True Induction Double Burner TI-2B Counter Inset Induction Cooktop Manual

Product(s): True Induction 1800w 2-Burner Induction Black Landscape Electric Cooktop (Model: TI-2B (S2F3), Newmar Part Number: 145601) or True Induction 1800w 2-Burner Induction Black Landscape Electric Cooktop (Model: TI-2B, Newmar Part Number: 124108)

Whale Seaward 3-Burner Princess Propane Cooktop (Models: 2276 and 3276)

This article provides basic operation instructions for a Whale Seaward 3-Burner Princess Propane Cooktop (Models: 2276 & 3276).

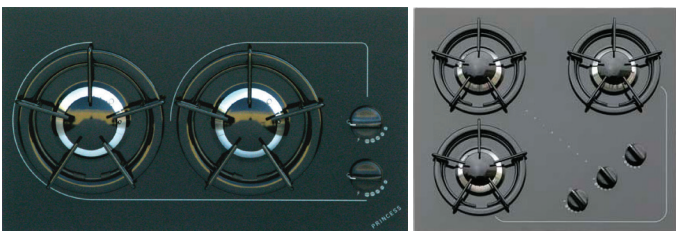

To Light The Burners

1. Push down the knob and turn counterclockwise to "IGNITE" position.
2. Hold the knob down fully until the spark ignites the gas and continue to hold the knob down for approximately 5 to 10 seconds. The thermocouple will be heated to activate the safety mechanism.
3. Release the knob and set to desired setting.
4. To turn off the burner flame, turn the knob clockwise to "OFF" position.

Cautions

- Be sure your cooktop is installed properly.
- Do not operate cooktop if it is damaged or not working properly.
- Do not store flammable materials on or near the cooktop.
- Never leave lit burners unattended. A boil-over may result, causing smoke or fire.
- Do not use your cooktop for warming or heating the room.
- The handle of utensil should be positioned so that it is turned inward but not extending over adjacent burner.
- To reduce the risk of burns and ignition of flammable materials, the burner flame should not extend beyond the edge of the cooking utensil.
- Grease is flammable. Never allow grease to collect around top burners or cooktop surface. Wipe spillovers immediately.
- Only certain types of glass, glass / ceramic, earthenware, or other glazed utensils are suitable for cooktop use without breaking due to sudden change in temperature.
- Do not use water on grease fire. Smother the fire or flame or use baking soda, multipurpose dry chemical or foam type fire extinguisher.
- Children should not be left alone or unattended in area where cooktop is in use.
- Children should never be allowed to sit or stand on any part of the cooktop.
- Do not heat unopened containers. They could explode.
- Do not touch burners, grates or areas near cooktop after use. Units may be hot even though it may not be obvious. Areas near burners and grates may become hot enough to cause burns. During and after use, do not touch, or let clothing or other flammable material contact cooktop or areas near it until they have had sufficient time to cool.

Source(s): Princess Model 2276 Owner's Manual - Installation - Operation - Maintenance and Princess Model G3276 Owner's Manual - Installation - Operation - Maintenance

Product(s): This source is associated with more than one product. Refer to Newgle for more information about the product(s) offered for your coach's model year.



Dishwashers

The perfect complement to the array of residential-class appliances making clean-up a breeze. Your coach may be equipped with a locking dishwasher drawer. This optional appliance is mounted in the kitchen cabinetry below the range featuring a stylish and high-end look.

Fisher Paykel Single DishDrawer Dishwasher Operation (Model: DD24SAX9)

This article provides basic operation instructions for a Fisher Paykel Single DishDrawer Dishwasher (Model: DD24SAX9).

⚠ IMPORTANT

For detailed information on the features of your dishwasher, see your 'User guide'. Before using your dishwasher, make sure you read the full 'User guide', with special attention to the 'Safety and warnings' section.

Operating Instructions - Starting A Wash

1. Discard scraps. Scrape large food particles off (e.g. bones, fruit stones) and remove any foreign objects (e.g. toothpicks, strings, paper).
2. Load dishes carefully. To help with wash performance, arrange dishes so they are evenly spaced and not nesting.
 - Accommodates plates up to a max height of 280mm (11") for standard tubs or 310mm (12 1/4") for tall tubs.
3. Check spray arm(s) are mounted correctly and can rotate fully around. Check the spray arm is mounted correctly by physically rotating it around with your hand. Before a wash, ensure there are no items blocking the spray arm(s) from rotating.
4. Add detergent. Fill the detergent dispenser with powdered detergent and close the dispenser door. If using a tablet or gel pouch, place it in the cutlery basket or at the edge of the base rack. See "Adding Detergent" section for more details.
5. Check rinse aid. If the indicator on its plug glows bright red, refill the rinse aid dispenser with liquid rinse aid. Make sure you then refit the rinse aid plug back into its original position, by rotating the plug back into an upright position.
6. Select wash. Power the dishwasher on then select wash program.

⚠ IMPORTANT

Do not place liquid detergent or tablets in the detergent dispenser.

- Start wash or set Delay start. Ensure drawer is closed.
 - To start wash: Press the Start/Pause button.
 - To set delay start: Press and hold the Start/Pause button to enter delay start, then press and hold the Start/Pause button again to increase the delay start time.

ADDING DETERGENT

POWDERED DISHWASHER DETERGENT

- Press the latch down to open the dispenser.
- Check that the dispenser is empty and dry, then add detergent (do not place solid or liquid tablets in the dispenser). No detergent is needed for the Rinse program.
- Close the dispenser until it clicks shut. The detergent will automatically be released into the drawer during the wash program.

Note: When washing heavily soiled dishes and in very hard water, you may also fill the secondary dispenser with detergent to aid dishwasher performance.

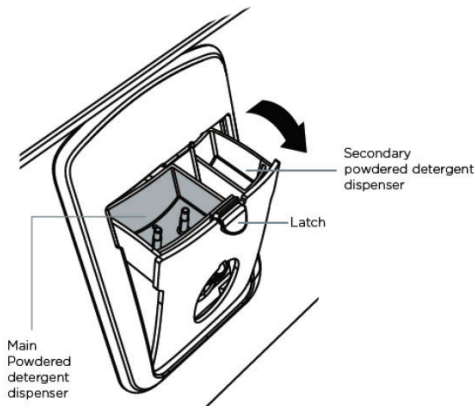

POUCH PACKS OF GEL OR POWDER OR SOLID DISHWASHER TABLETS

Place on tablet tray in the cutlery basket. If the cutlery basket is not being used for a particular load, wedge pack between the racking on the side.

IMPORTANT

Don't place the pack or tablet on the floor of the drawer, as it may interfere with the spray arm rotation and affect wash performance.

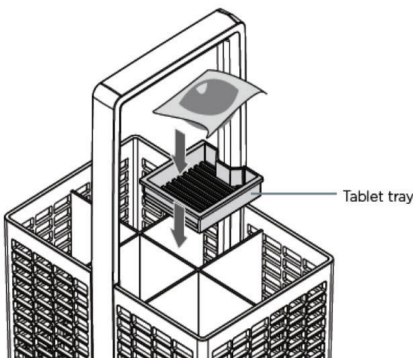

Notes on using tablets:

- If you are using tablets, follow manufacturer instructions on the packet. Some tablets may not be suitable for all wash programs.
- Using tablets could improve wash performance in hard water areas.
- Make sure that tablets never get in direct contact with dishes or cutlery.
- If you are using dishwasher tablets with a built-in rinse aid component, we recommend turning off the rinse aid.

IMPORTANT

Dishwasher detergents are strongly alkaline. They can be extremely dangerous if swallowed. Avoid contact with the skin and eyes and keep children and infirm persons away from the dishwasher when it is open. Check that the powdered detergent dispenser is empty after completion of the wash program.

UNSUITABLE DETERGENTS

These types of detergent are not suitable and may damage your dishwasher and lead to a service call that is not covered by warranty.

IMPORTANT

Do NOT use these in your dishwasher:

- Liquid detergents
- Laundry detergents
- Hand washing liquids
- Soaps
- Disinfectants

HOW MUCH DETERGENT TO USE

For powdered detergent... follow the quantities relevant to your location and water hardness level. Use the markings to help you measure the correct quantities. For other types of detergent, follow the manufacturer's recommendations.

Controls and Indicators

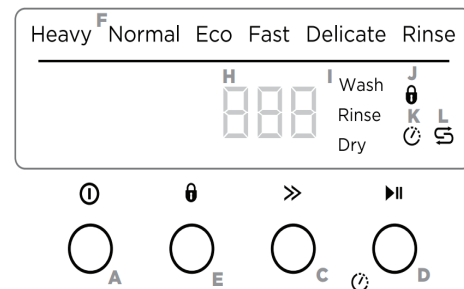

(A) OFF/ON

Press the Power button to turn the dishdrawer on or off. Opening the drawer will automatically turn the dishwasher on.

(C) WASH PROGRAM SELECTOR

Press the Fast Forward button to scroll through wash program options.

(D) START / DELAY START

Press the Play/Pause button to start the wash. To pause: Press the Play/Pause button again. The wash stage indicator will flash.

- Wait for the 3 short and one long tone before opening the drawer. Forcing it open mid-cycle may cause damage or injury.
- If the drawer is not restarted within 7 minutes, it will tone intermittently until it is restarted.

TO DELAY START

- Press and hold until the Play/Pause button until the “1h” appears on the display, then release. You are now in Delay start mode.
- Press the Play/Pause button until the display shows the number of hours you want to delay the start of a wash by (1 to 12 hours). Note: If you scroll past 12 hours, the dishwasher will exit Delay start mode. To re-enter delay start, go back to the previous step.
- The wash will start once the delay time is over, provided the drawer is closed. If the drawer is opened after delay start has been set (for example if you need to load more dishes), delay start will be paused after the drawer is closed.

TO RESTART DELAY START

- Close the drawer. The clock icon will flash.
- Press the Play/Pause button to resume.

CANCEL WASH/CANCEL DELAY START

- Press the Power button to cancel a wash that has already started or to cancel the Delay start setting.
- If there is any water in the drawer, it will automatically drain before the dishwasher turns off.

(E) KEYLOCK

Keylock disables all the buttons – helpful when cleaning the dishwasher.

- To activate: press and hold the Lock button until you hear one tone. The keylock indicator will come on.
- To cancel: press and hold the Lock button until you hear another tone and the keylock indicator stops flashing and goes out.

(E) CHILDLCK

Childlock disables all the buttons and locks the drawer closed, preventing unauthorized use by children.

- To activate: press and hold the Lock button until you hear a second tone. The keylock indicator will come on.
- To cancel: press and hold the Lock button until you hear another tone and the keylock indicator stops flashing and goes out.

(F) WASH PROGRAM INDICATORS

These show which program is selected.

(H) DISPLAY

- Time remaining (minutes)
- Fault code numbers (see ‘If there is a fault’ in User guide).

(I) WASH STAGE INDICATORS

- (See ‘During and after the wash cycle’).

(J) KEYLOCK/CHILDLCK INDICATOR

- If lit: keylock or childlock is activated.

(K) DELAYED START INDICATOR

- If lit: delayed start is set.

(L) SALT INDICATOR

- If lit: salt reservoir is empty. (Water softener models only)

Wash Programs

Press the Fast Forward button to scroll through the wash program options.

Wash Program	Description
Heavy	Heavily soiled pots, pans and dishes.
Normal (Default)	Dishes that are quite heavily soiled or food soils that have been left to dry overnight.
Normal Eco	Normally soiled dishes for optimum water and energy usage.
Fast	Lightly soiled dishes.
Delicate	Lightly soiled and heat sensitive crockery.
Rinse	Prevents odors and soils from drying on dishes.

During and After The Wash

As the wash progresses, the display will count down the minutes remaining and show what stage the program is at.

When the program has finished, the display will show 0 and the dishwasher will sound a tone. After 30 seconds the display will go out. You may notice the following noises at the end of the wash. These are all part of normal operation:

- The drying fan may continue to run after a wash program has finished for a set time or until the drawer is opened. The fan assists with drying and uses negligible amounts of energy.

For best drying results, we recommend unloading the dishes once they have cooled.

Before Travel

NOTE FROM NEWMAR

Before traveling, lock the dishwasher drawer in the closed position. It is critical that the dishwasher drawer be locked into place any time the unit is in transit. If it is not, it can extend suddenly without warning, potentially damaging the dishwasher, its contents, the cabinetry, and may become dangerous to anyone standing near it.

Source(s): Fisher & Paykel DishDrawer Dishwasher Quick Start Guide 591149 D (02.19) and Fisher & Paykel DishDrawer Dishwasher User Guide DD60, DD24 Double and Single Models (11.17)

Product(s): Fisher Paykel 24" Stainless Steel Single Drawer Dishwasher (Model: DD24SAX9, Newmar Part Number: 138330)



Microwaves and Convection Ovens

A modern convenience to keep up with even your busiest of travel days. Newmar offers a variety of microwave and convection oven choices to meet your needs and wants to make cooking quick and convenient.

With multiple cooking functions, your microwave allows you to do much more than just warming up last night's leftovers. With the use of a combination of lights, microwaves, and convection heat, preparing entire meals is possible in a fraction of the time it takes in a conventional oven.

All microwaves and convection ovens operate on 120 Volt electricity. The control panel is a touch pad, so entering the temperature, mode, and cooking time desired is simple. A range hood may be incorporated into the microwave. The microwave's control panel also operates the range hood functions, including the fan and light. The fan has two speeds: low and high.

Whirlpool Convection Smart Microwave Operation (Models: WMH78019HZ and WMH78019HB)

This article provides basic operation instructions for a Whirlpool Convection Smart Microwave (Models: WMH78019HZ and WMH78019HB).

Control Panel

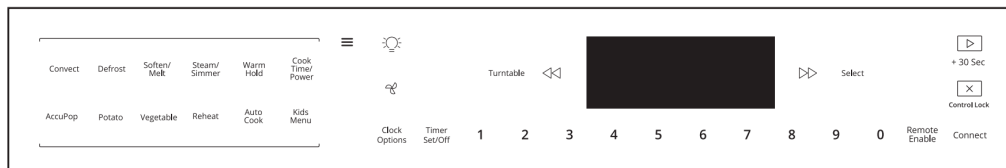

CLOCK/OPTIONS

SET THE CLOCK

1. To set the clock, for example, to 2:25 PM, touch the Menu keypad.
2. Touch CLOCK/OPTIONS.
3. Use the number keypads to enter "2:25."
4. Touch SELECT.
5. Touch "2" to display PM.

REACH OPTIONS MENU

1. Touch CLOCK/OPTIONS.
2. Use the arrow keypads to scroll through options.
3. Touch SELECT to select desired option and follow the prompts.



LIGHT: TURN ON LIGHT

1. Press the Light keypad to turn the light beneath the hood on or off.



FAN: TURN ON FAN

1. Press the Fan keypad to turn the Fan on or off. Press the fan keypad repeatedly to change from low to high.



TIMER (SET/OFF): KITCHEN TIMER

1. Touch TIMER SET/OFF.
2. Touch the number keypads to set the length of time. For example, to set 12 minutes length time, touch TIME SET/OFF.
3. Use the number keypads to enter "12:00."
4. Touch START.
5. If the Cancel keypad is touched, the microwave oven will turn off; however, the Timer can only be turned off using the Timer Set/Off keypad.



START/ADD 30 SEC

Touching the Start/Add 30 Sec keypad when the microwave oven is off will start 30 seconds of cook time at 100% power. If cooking is interrupted by opening the door, touching Start/Add 30 Sec after the door is closed again will resume the preset cycle.

NOTE: The START button displays like a PLAY button. It functions as both the START and the (+30 Sec) ADD 30 SECONDS function for this microwave. When referencing the following user instructions, "pressing the START/+30 Sec" button means pressing this "PLAY" button.



CANCEL
CANCEL COOKING FUNCTION

Touch the Cancel keypad to cancel cooking function. The Cancel keypad stops any microwave oven function except for the Clock, Timer, and Control Lock.

The microwave oven will also turn off when the door is opened. When the door is opened, the element(s) and fan will turn off, but the microwave oven light will remain on. Close the door and touch the Start keypad to resume the preset cycle.

The microwave oven cooling fan may continue to operate even after a microwave oven function has been canceled or completed, depending on the microwave oven temperature.

ACTIVATE CONTROL LOCK

Activate to avoid unintended start. Touch and hold the Cancel keypad for about 3 seconds until two tones sound and the Padlock icon appears in the display. Repeat to unlock control.



LEFT AND RIGHT ARROWS:
NAVIGATE MENU

Press the Left or Right Arrow keypad to move through the menu.



SELECT: OPTIONS

Touch SELECT to select options.



TURNTABLE: ON/OFF

By touching the Turntable On/Off keypad, it is possible to switch the turntable on and off during some microwave cycles. The turntable can be turned on or off only during Manual cooking cycles.



CONNECT: WI-FI

Press and hold CONNECT while your router's WPS indicator light is blinking to connect your range to your Wi-Fi network.



Refrigerators, Freezers and Ice Makers

Offering all of the ingredients you need for a satisfying life on the road. Newmar offers many quality options for your food storage needs, all while blending beautifully with your sleek decor. With adjustable and removable shelving, your refrigerator and freezer provides you with the flexibility you need to fit your on-the-road lifestyle. Many models offer the convenience of electronic controls, a built in icemaker, and a filtered water dispenser.



REMOTE ENABLE: ENABLE REMOTE APP CONTROL

Remote Enable allows you to start Convection Bake cooking cycle using your mobile phone when you are away from home. Press REMOTE ENABLE to enable the ability to utilize the Whirlpool® app.

Cooking Options and Additional Features

MENU: TURN ON BACKLIT BUTTONS

1. Press the Menu keypad to light up the back-lit buttons.
 - Convection: Auto Convection Cooking, Manual Convection Bake, Manual Convection Roast
 - Defrost: Automatic Defrost
 - Soften/Melt: Soften, Melt
 - Steam/Simmer: Auto Steam Cook, Manual Steam Cook, Auto Simmer Cook, Manual Simmer Cook
 - Warm Hold: Keep Food Warm
 - Cook Time/Power: Manual Cooking
 - AccuPop: Popcorn (Sensor)
 - Potato: Potato (Sensor)
 - Vegetable: Vegetable
 - Reheat: Automatic Reheat
 - Auto Cook: Auto Cook
 - Kids Menu: Kids Menu

Convection	Defrost	Soften/Melt	Steam/Simmer	Warm Hold	Cook Time/Power
AccuPop	Potato	Vegetable	Reheat	Auto Cook	Kids Menu

For more information about the cooking options and additional features, refer to the “Whirlpool Convection Smart Microwave (WMH78019HZ) User Instruction Manual.”

*Source(s): Whirlpool Convection Smart Microwave (WMH78019HZ) User Instructions
Product(s): Whirlpool 30" 1.9 Cu Ft 1100w Convection Smart Microwave (Model: WMH78019HZ, Newmar Part Number: 140692) and Whirlpool 30" 19 Cu Ft 1100w Black Convection Microwave (Model: WMH78019HB, Newmar Part Number: 143251)*





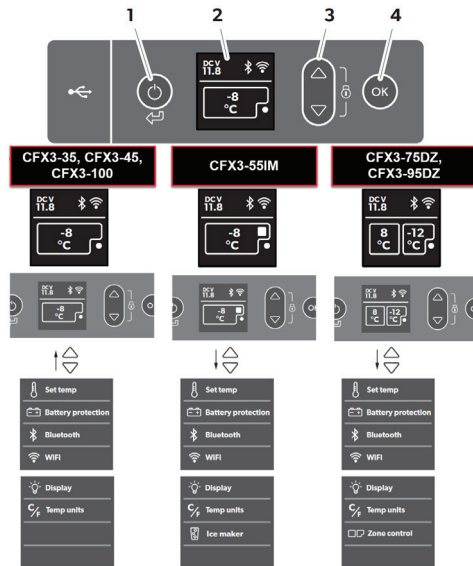

Exterior Portable Freezers

Dometic Exterior Portable Freezer Operation (Model: CFX3-45, CFX3-55IM, CFX3-75DZ, and CFX3-95DZ)

This article provides basic operation instructions for a Dometic Exterior Portable Freezer (Model: CFX3-45, CFX3-55IM, CFX3-75DZ, and CFX3-95DZ).

Operating and Display Elements



Item	Description	Explanation
1		Switches the cooler on when the button is pressed briefly Switches the cooler off when the button is pressed for three seconds Returns to the previous menu
2	Display	Shows the information ac : AC power supply is connected DCV : DC power supply is connected Bluetooth : Bluetooth is activated WiFi : WiFi is activated Display lock : Display is locked Compressor : Compressor is working Ice maker : Ice maker is working (CFX3 55IM only)
3		Press  to navigate upwards or to increase the selected value. Press  to navigate downwards or to decrease the selected value. Press  and  simultaneously for 3 s to lock or unlock the display.
4		Press to select a menu or to save the selected value.

DISPLAY STATES

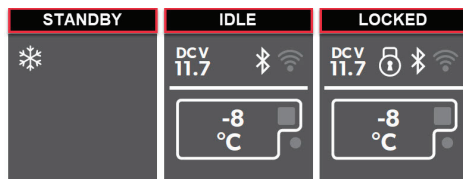

CFX3 App

DOWNLOADING THE APP

The cooler can be monitored and controlled via Bluetooth or WiFi using an app that you can install on a compatible device. Download the CFX3 app from App Store or Google Play. Note that the CFX3 app may not be available in your country.

SETTING THE BLUETOOTH SIGNAL AND CONNECTING TO THE APP

The cooler can be monitored and controlled via Bluetooth. To do so, you have to pair the cooler with your Bluetooth device.

NOTICE

- Pairing must be done within the CFX3 app, not in device settings.
- There is no password required for Bluetooth connection.

SETTING THE WIFI SIGNAL AND CONNECTING TO THE APP

The cooler can be monitored and controlled via WiFi direct to cooler or via a WiFi network.

For WiFi direct to cooler, go to device settings and select your cooler.

- The WiFi name of your cooler begins with “CFX3”.
- The preset password is “00000000”.
- You can personalise the WiFi name and the password in the CFX3 app.

NOTICE

For connection via WiFi network, go to “network connection” in the app SETTINGS.

CHANGING CFX NAME AND PASSWORD IN THE APP

- You can personalise the name of your CFX in the app.
- The same name applies to both Bluetooth and WiFi.
- You can also personalise your password in the app -applicable only to WiFi.

Proceed to “CFX name and password” in the app SETTINGS.

RESETTING THE APP PASSWORD (WIFI ONLY)

You can reset the app password to the factory setting “00000000”.

RESETTING TO FACTORY SETTINGS

The reset function changes all display menu and app fields to the original factory settings.

USB Port

The USB port allows you to charge small devices like mobile phones and mp3 players.

⚠ IMPORTANT

Ensure that any small device connected to the USB port is compatible with 5 V/2 A operation.

Defrosting The Cooler

Humidity can form frost in the interior of the cooling device or on the evaporator. This reduces the cooling capacity. Defrost the device in good time to avoid this.

⚠ CAUTION

Never use hard or pointed tools to remove ice or to loosen objects which have frozen in place.

To defrost the cooler, proceed as follows:

1. Take out the contents of the cooler.
2. If necessary, place them in another cooling device to keep them cool.
3. Switch off the device.
4. Leave the lid open.
5. Wipe off the defrosted water.

Source(s): Dometic Mobile Cooling CFX3 Operating Manual (CFX3 35, CFX3 45, CFX3 55IM, CFX3 75DZ, CFX3 95DZ, CFX3 100)

Product(s): This source is associated with more than one product. Refer to Newgle for more information about the product(s) offered for your coach's model year.)

Residential-Style Refrigerators

This article provides a general overview of how a residential-style refrigerator operates.

Residential-style refrigerators are the most popular option installed in Newmar coaches. The refrigerator operates on 120 volt AC power and uses freon and a compressor to keep your food cold and fresh. The power may be supplied by the electrical hookup at the campsite, generator power or (in most coaches) an inverter with a charged house battery bank.

For models with a built-in ice maker, a pressurized water supply is required. In order for the ice maker to operate, you must have water in the fresh tank and have the water pump turned on, or your coach must be connected to city water supply.

When placing items on the racks and in the bins, leave enough space for air to flow throughout the entire refrigerator cabinet.

All models are equipped with a means to latch and secure the doors for a tight seal and to prevent the doors from opening during transit. Become familiar with the latch operation and always lock prior to traveling.

Whirlpool French Door Refrigerator with Water Dispenser Operation (Models: WRF560SEHZ and WRF560SEYM)

This article provides basic operation instructions for a Whirlpool French Door Refrigerator with Water Dispenser (Models: WRF560SEHZ and WRF560SEYM).

There are two refrigerator compartment doors. The doors can be opened and closed either separately or together. There is a vertically-hinged seal on the left refrigerator door.

- When the left-hand refrigerator door is opened, the hinged seal automatically folds inward so that it is out of the way.
- When both doors are closed, the hinged seal automatically forms a seal between the 2 doors.

- The recommended setting should be correct for normal household refrigerator use. The controls are set correctly when milk or juice is as cold as you like and when ice cream is firm.
- If the temperature is too warm or too cold in the refrigerator or freezer, first check the air vents to be sure they are not blocked before adjusting the controls.

Using The Controls

⚠ IMPORTANT

Wait 24 hours for your refrigerator to cool completely before adding food. If you add food before the refrigerator has cooled completely, your food may spoil. Adjusting the refrigerator and freezer temperature controls to a colder than recommended setting will not cool the compartments any faster.

Depending on your model, your refrigerator has either an internal control panel, located at the top of the refrigerator compartment, or an external control panel, located above the external water dispenser. Follow the instructions specific to your model.

The display screen on the dispenser control panel will turn off automatically and enter "sleep" mode when the control buttons and dispenser paddles have not been used for 2 minutes or more. While in "sleep" mode, the first press of a control button will only reactivate the display screen, without changing any settings. After

reactivation, changes to any settings can then be made. If no changes are made within 2 minutes, the display will re-enter “sleep” mode. Touch any control button on the dispenser panel to activate the display screen.

TEMPERATURE CONTROL

For your convenience, the temperature control is preset at the factory. When you first install your refrigerator, make sure the control is still set to the recommended setting (3 Snowflakes).

ADJUSTING THE CONTROLS

If you need to adjust the temperature in either the refrigerator or freezer compartment, use the settings listed in the following chart as a guide.

- Press the Temp button to display the desired number of snowflakes from 1 snowflake (least cold) to all 5 snowflakes (coldest).

NOTE: Except when starting the refrigerator, do not adjust the control more than one setting at a time. Wait 24 hours between adjustments for the temperature to stabilize.

Condition/Reason	Adjustment
Refrigerator too warm	Fridge Temp: One more snowflake
Freezer too warm or too little ice	Freezer Temp: One more snowflake
Refrigerator too cold	Fridge Temp: One less snowflake
Freezer too cold	Freezer Temp: One less snowflake

COOLING ON/OFF

INTERNAL CONTROL PANEL

- To turn cooling off, press and hold both the Fast Cool and Moisture Control buttons at the same time for 3 seconds. When cooling is OFF, “Cooling Off” will appear on the display screen.
- To turn cooling back on, press and hold both the Fast Cool and Moisture Control buttons at the same time for 3 seconds. When cooling is ON, “Cooling Off” will disappear and the previously selected settings will appear on the display screen.

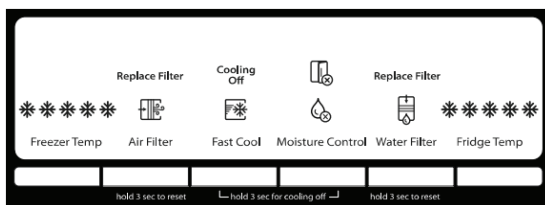

Internal Control Panel

EXTERNAL CONTROL PANEL

- To turn cooling off, press and hold both the Freezer Temp and Fridge Temp buttons at the same time for 3 seconds. When cooling is off, “Cooling Off” will appear on the display screen.
- To turn cooling back on. Press and hold both the Freezer Temp and Fridge Temp buttons at the same time for 3 seconds. When cooling is on, “Cooling Off” will disappear and the previously selected settings will appear on the display screen.

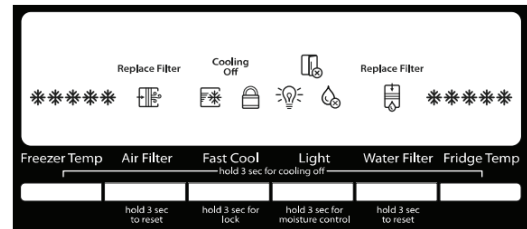

External Control Panel

Additional Features

DOOR OPEN ALARM

- The Door Open icon lights up whenever either door is opened.
- When either door is open for 5 minutes and cooling is on, an alert tone will sound three times, and the Door Open icon will flash seven times. This pattern will repeat every 2 minutes until all the doors are closed properly. The feature then resets and will reactivate when either door is left open again for 5 minutes.

NOTES:

- To mute the audible alarm while keeping the doors open, such as while cleaning the inside of the refrigerator, press any button on the control panel. The alarm sound will be temporarily turned off, but the Door Open icon will still be displayed on the dispenser control panel.
- Both doors must be fully closed to turn off the Door Open icon.

FAST COOL

The Fast Cool feature assists during times of high refrigerator use, full grocery loads or temporarily warm room temperatures.

- Press FAST COOL to set the freezer and refrigerator to the coldest temperature settings. Press FAST COOL again to return to the selected temperature set point.

NOTES:

- The Fast Cool icon will be illuminated while the refrigerator is in Fast Cool mode.
- The Fast Cool feature will turn off automatically after 24 hours.

MOISTURE CONTROL

The moisture control feature turns on a heater to help reduce moisture on the door hinge seal. Use in humid environments or when you notice moisture on the door hinge seal. The refrigerator uses more energy when Moisture Control is ON.

NOTE: The moisture control icon will light up to indicate the feature is ON. To turn on/off the moisture control feature:

- Internal Control Panel - Press and hold MOISTURE CONTROL for 3 seconds.
- External Control Panel - Press and hold LIGHT for 3 seconds.

WATER FILTER STATUS LIGHT AND RESET

The filter reset control allows you to restart the water filter status tracking feature each time you replace the water filter.

- Press and hold WATER FILTER for 3 seconds, to reset the water filter status to Good. The water filter icon will turn blue.

AIR FILTER STATUS LIGHT AND RESET

The filter reset control allows you to restart the air filter status tracking feature each time you replace the air filter.

- Press and hold AIR FILTER for 3 seconds, to reset the air filter status to Good. The air filter icon will turn blue.

WATER DISPENSER (ON SOME MODELS)

IMPORTANT:

- Allow 3 hours for the refrigerator to cool down and chill water.
- Allow 24 hours to produce the first batch of ice. Discard the first three batches of ice produced.
- The dispensing system will not operate when the refrigerator door is open.

FLUSH THE WATER SYSTEM

Air in the water dispensing system can cause the water dispenser to drip. After connecting the refrigerator to a water source or replacing the water filter, flush the water system. Flushing the water dispensing system forces air from the water line and filter and prepares the water filter for use. Additional flushing may be required in some households.

NOTE: As air is cleared from the system, water may spurt out of the dispenser.

- Using a sturdy container, depress and hold the water dispenser paddle for 5 seconds.
- Release the dispenser paddle for 5 seconds.
- Repeat steps 1 and 2 until water begins to flow.
- Once water begins to flow, continue depressing and releasing the dispenser paddle (5 seconds on, 5 seconds off) until a total of 4 gal. (15 L) has been dispensed.

DISPENSE WATER

IMPORTANT:

- The dispensing system will not operate when the refrigerator door is open.
- The display screen on the dispenser control panel will turn off automatically and enter “sleep” mode when the control buttons and dispenser paddles have not been used for 2 minutes or more. While in “sleep” mode, the first press of a control button will only reactivate the display screen, without changing any settings. After reactivation, changes to any settings can then be made. If no changes are made within 2 minutes, the display will re-enter “sleep” mode.

To dispense water, press a sturdy glass against the water dispenser paddle. Remove the glass to stop dispensing.

DISPENSER LIGHT

When you use the dispenser, the light will automatically turn on. If you want the light to be on continuously, you may turn on the light. The light icon will illuminate when the light is ON.

- ON: Press LIGHT quickly to turn on the dispenser light.
- OFF: Press LIGHT quickly to turn off the dispenser light.

NOTES:

- If you unintentionally press and hold the Light button for 3 seconds or longer, you will turn on the Moisture Control feature. If this happens, press and hold LIGHT for 3 seconds again to turn off the Moisture Control feature. The dispenser lights are LEDs that cannot be changed.

DISPENSER LOCK

The dispenser can be turned off for easy cleaning or to avoid unintentional dispensing by small children and pets.

NOTE: The lock feature does not shut off power to the refrigerator, to the ice maker, or to the dispenser light. It simply deactivates the controls and dispenser paddles.

- Press and hold FAST COOL for 3 seconds to lock the dispenser.
- Press and hold FAST COOL for 3 seconds again to unlock the dispenser. The lock icon will illuminate when the dispenser is locked.

Ice Maker

IMPORTANT: For models with a water filter, after connecting the refrigerator to a water source or replacing the water filter, fill and discard 3 full containers of ice to prepare the water filter for use.

TURNING THE ICE MAKER ON/OFF

To turn on the ice maker, simply lower the wire shut-off arm. To manually turn off the ice maker, lift the wire shut-off arm to the OFF (arm up) position and listen for the click.

NOTE: Your ice maker has an automatic shutoff. As ice is made, the ice cubes will fill the ice storage bin and the ice cubes will raise the wire shut-off arm to the OFF (arm up) position. Do not force the wire shut-off arm up or down.

ICE STORAGE BIN

1. Wash the ice storage bin with mild soap and warm water.
2. Slide the ice storage bin under the ice maker and push it toward the back as far as it will go.
3. Lower the arm on the ice maker to the ON position.

NOTE: It usually takes approximately 24 hours for the ice maker to begin producing ice. You may notice the ice has an “off-taste.” If so, discard the first 3 batches of ice produced. After that the “off-taste” should be gone.

ICE PRODUCTION RATE

- The ice maker should produce approximately 8 to 12 batches of ice in a 24-hour period. Allow 3 days to completely fill the ice container.
- To increase ice production, lower the freezer and refrigerator temperature. Wait 24 hours between adjustments.
- The quality of your ice will be only as good as the quality of the water supplied to your ice maker. Avoid connecting the ice maker to a softened water supply. Water softener chemicals (such as salt) can damage parts of the ice maker and lead to poor quality ice. If a softened water supply cannot be avoided, make sure the water softener is operating properly and is well maintained.
- Do not use anything sharp to break up the ice in the bin. This can cause damage to the ice storage bin and the dispenser mechanism.
- Do not store anything on top of or in the ice maker or ice storage bin.

Source(s): Whirlpool WRF560 Refrigerator User Instructions

Product(s): Whirlpool Stainless Steel 20 Cu Ft Refrigerator with Water in Door (Model: WFR560SEHZ, Newmar Part Number: 146572) and Whirlpool 19.6 Cu Ft Monochromatic Stainless Steel French Door Refrigerator w/ Thru-the-Door Water Dispenser (Model: WRF560SEYM, Newmar Part Number: 130238)



Vacuums

Central cleaning systems make cleanup a snap, leaving you with more time to do what you enjoy. Your central vacuum removes dirt and debris inside of your coach. The central vacuum includes tools to effectively and efficiently clean all surfaces of your coach, including carpets, tile, furniture, window treatments, and more.

RoadVac by InterVac Central Vacuum Operation (Model: CS-RM)

This article provides basic operation instructions for a RoadVac by InterVac Central Vacuum system (Model: CS-RM).

Operating The Vacuum

To operate the vacuum, make sure 120 volt power is being supplied to the vacuum outlet. The vacuum must be plugged in, and the power switch must be in the OFF position when using the remote control on the pistol grip. The vacuum will only turn ON when the Remote Control Pistol Grip button has been pressed or when the switch on the vacuum has been turned ON.



Pressing the Pistol Grip button for less than a second will turn the vacuum ON or OFF. Do not hold down the button, as it will greatly reduce battery life. When the Pistol Grip Transmitter button is held down continuously, it will continue to transmit for 9 seconds, and then turn OFF. If the performance (range) in which the Pistol Grip functions away from the receiver has reduced, replace the battery to correct the issues.

Note: Replacing the battery may require the Pistol Grip Remote to be reprogrammed. (For more information about the Pistol Grip, refer to the file in Newgle named “InterVac Pistol Grip Remote Control Description, Installation and Programming”.)

Replacing The Vacuum Double-Collar Bag

Replacement bag: Part #Y11 high filtration 5-layer fiber bag

1. Remove the front panel on the vacuum cleaner by sliding the latch/lock and removing the front panel with dust bag attached.
2. Remove full bag and discard.
3. Notice: The #Y11 double-sided bag has two openings. The collar which attaches to the back of the vacuum chamber is clearly marked “Push this collar over pipe in the back of the vacuum chamber first.”
4. Hold the dust bag by the edges of the cardboard in your hand. Push onto the pipe in the back of the chamber holding at about a 45 degree angle, and then push down the lower part of the collar against the back wall until flush.
5. Push the front cardboard collar of the dust bag all the way over the pipe on the front panel.
6. Slide the front panel into the small slots on the side of the vacuum’s frame. Ensure dust bag is completely inside compartment, then push it into the frame until the lock/latch clicks into place.

Changing The Motor Filter

Replacement: Part #Y22

1. Remove the front panel with dust bag.
2. Inside the vacuum chamber, you will see the filter with the arrow pointing towards the back wall. Replace the filter with a new or cleaned filter, with the arrow pointing towards the back wall.
3. If the filter is dirty, you can wash it by hand in a mild soap solution. Do NOT clean in washing machine. Let filter dry completely before reusing.

Source(s): InterVac CS Series Installation and Operating Manual

Product(s): InterVac Central Vac System (Model: CS-RM, Newmar Part Number: 142013)



Washer and Dryer Overview

This article provides an overview of the washer and dryer operation, information about coaches that are prepped for an after-market installation, as well as an explanation of the washer’s p-trap.

Overview

Depending on your model, year, and available options, your coach may be equipped with a stackable washer and dryer, or an all-in-one laundry center located in a cabinet. They are built for life on the road, so they are compact to save space, weight, and resources, without sacrificing performance.



Some coach floorplans may also provide the option for washer and dryer hookups, in lieu of the appliances. If a washer and dryer unit is not installed in your coach, it may be prepped at the factory so that a unit can be added later. Coaches not ordered and/or installed by the factory will not be covered by Newmar’s warranty.

Operation

The plumbing and other preparations for the installation of a compact washer and dryer are optional features on your coach. The washers and dryers function like those in a home. Most operate on 120 volt electricity; however, some dryers may require 240 volt electricity. Newmar does not recommend using your washer and dryer during transit. For information about your installed washer and dryer, refer to Newgle’s product pages, which are specific to the appliance manufacturer and model.

WASHER WASTE WATER DRAINAGE

Before operating the washing machine:

1. Remove the outside drain cap in the exterior water compartment. The drain cover is used to prevent leakage of waste material when not in use.
2. Attach the sewer or macerator hose to the drain outlet. The drain line or macerator hose should be used to direct waste to the dump station for proper disposal. For more information about draining the waste water holding tanks, refer to the Waste Water Disposal article in Newgle.

3. Open the gray tank valve all the way by pulling on the appropriately-labeled T-handle or operating the electric gate valve (if equipped). The tank will start to drain to the drain outlet or macerator hose (if equipped and connected) as soon as the T-handle is pulled or the electric gate valve is operated. Opening the gray tank valve will allow the washing machine water to drain instead of overflowing the waste water tank.

NOTICE

Remove outside drain cap before operating washing machine.

NI-12

DRAIN OUTLET

AD-18

P-Traps

Each of the sink drains, the shower drain, and the washing machine drain (if equipped) has a water trap to prevent holding tank odors from entering the coach. These traps must have water in them in order to trap the odors. While stored, the water may evaporate, allowing an odor to enter the coach. If this occurs, run water from the faucet into the drain, allowing water to fill the trap. Run water into the washing machine. Set the cycle to spin to drain the water to fill the p-trap.

⚠ IMPORTANT

If the outside drain cap is not removed and the gray tank valve is not in the “open” position, the gray tank may overflow.



Splendide Front-Loading Washer Operation (Model: WFL1300XD)

This article provides basic operation instructions for a Splendide Front-Loading Washer (Model: WFL1300XD).

Control Panel

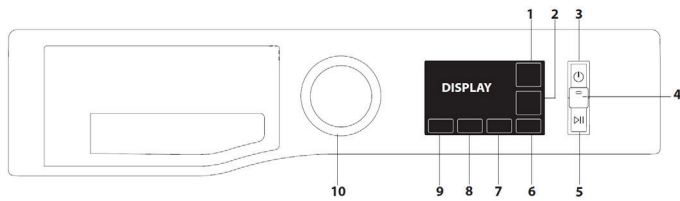

1. SUPER WASH / MUTE button
2. POST CYCLE CARE / KEY LOCK button
3. ON/OFF button
4. PREWASH button and indicator light
5. START/PAUSE button
6. EXTRA RINSE button
7. DELAY START button
8. SPIN button
9. TEMPERATURE button
10. WASH CYCLE SELECTOR KNOB

Detergent Dispenser Drawer

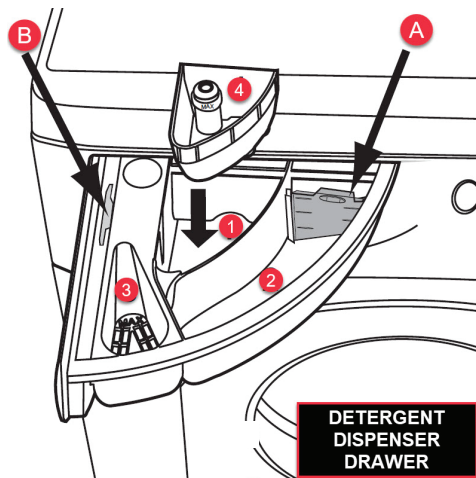

Compartment 1: Pre-wash detergent (powder)

Compartment 2: Detergent for the wash cycle (powder or liquid)

- If liquid detergent is used, it is recommended that the removable plastic partition A (supplied) be used for proper dosage.
- If powder detergent is used, place the partition into slot B.

Compartment 3: Additives (fabric softeners, etc.)

- The fabric softener should not overflow the grid.

Extra Compartment 4: Bleach

Note: Splendide recommends using 1 to 2 tbsp. of a bio-friendly fabric softener, or similar brand per wash load. These softeners tend to appear light in color and dissolve more quickly in less water, minimizing build-up within your machine.

Note: Use powder detergent for white cotton garments, for pre-washing, and for washing with hot temperatures.

Note: Follow the instructions given on the detergent packaging.

Display

The display is useful when programming the washing machine and provides plenty of information.

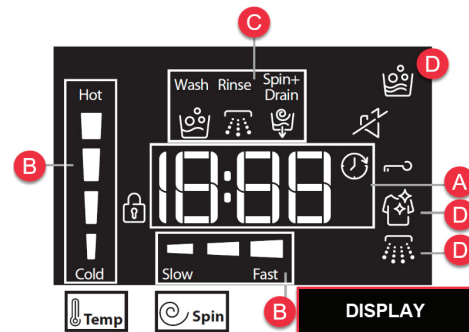

SECTION A

The duration of the available wash cycles and the remaining time of a running cycle appear in section A (Factors such as load size, modifiers, options selected, and water pressure may affect the time shown in the display. Tightly packed loads, unbalanced loads, or excessive suds may cause the washer to lengthen the cycle time as well); if the DELAYED START option has been set, the countdown to the start of the selected wash cycle will appear.

SECTION B

In section B, pressing the corresponding button allows you to view the maximum spin speed and temperature values attained by the machine during the set wash cycle, or the values selected most recently, if these are compatible with the set wash cycle.

SECTION C

The “wash cycle phases” corresponding to the selected wash cycle and the “wash cycle phase” of the running wash cycle appear in section C: Wash, Rinse, Spin + Drain.

SECTION D

References D indicate the wash options available. For a list of these options, refer to Splendide’s Instruction Manual.

DELAY START

The “Delay Start” symbol [clock icon], when lit, indicates that the set “delayed start” value has appeared on the display.

MUTE

The “Mute” symbol [speaker icon] indicates the possibility to silence the key tones. While the mute is active, almost all sounds will be turned off. Only the sound signals and the alarms remain active, as well as the sound of the end of cycle. To activate/deactivate, press and hold the mute button.

KEY LOCK

To lock the control panel, press and hold the “Key lock” button for approximately 3 seconds. The symbol will light up on the display to indicate that the control panel has been locked (with the exception of the “ON/OFF” button). This prevents unintentional changes to programs, especially with children near the machine. To unlock the control panel, press and hold the “Key lock” button for approximately 3 seconds.

LOCKED DOOR INDICATOR

When lit, the symbol indicates that the door is locked. To prevent any damage, wait until the symbol turns off before opening the door. To open the door while a cycle is in progress, press the START/PAUSE button; if the LOCK symbol is off, the door can be opened.

First Time Use

Once the appliance has been installed, and before it is used for the first time, run a “Clean Washer” cycle with liquid chlorine bleach and no laundry.

Daily Use

- Press the ON/OFF button.
- Open the door. Load the laundry while making sure not to exceed the maximum load quantity indicated in the wash cycle table.
- Pull out the detergent dispenser drawer and pour the detergent into the relevant compartments, as described in the “DETERGENT DISPENSER DRAWER” section. - Close the door.
- The machine automatically displays the default temperature and spin speed values for the selected cycle, or the most recently used settings for that specific cycle.
- Select the desired wash cycle.
- Select the desired options.
- Press and hold the START/PAUSE button to start the wash.

⚠ IMPORTANT

For more information about wash settings, cleaning and maintenance, and winterization, refer to Splendide’s Instruction Manual.

Source(s): WFL1300XD Splendide Washing Machine Instruction Manual
 Product(s): Splendide WFL1300XD 24-in Front-Loading Washer (Model: WFL1300XD, Newmar Part Number: 156340)

Splendide Tumble Dryer Operation (Model: DV6400X)

This article provides basic operation and cleaning instructions for a Splendide Tumble Dryer (Model: DV6400X).

Control Panel

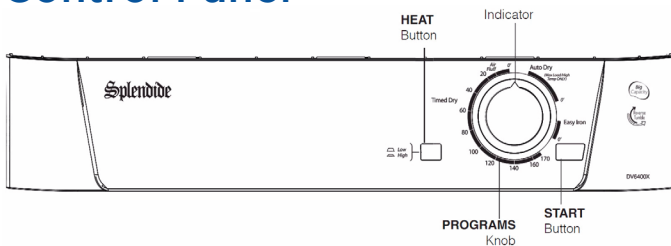

The START button begins drying a selected program (see Start and Programs in the Owner’s Manual).

The HEAT button selects drying temperature (see Start and Programs).

- IN: HIGH heat.
- OUT: LOW heat

The Drying Guide allows you to consult a user friendly table of fabric types and load capacities.

The Special Programs Guide gives a guide to the available programs.

The PROGRAMS knob sets the program: rotate it clockwise, never counter-clockwise, until the indicator is pointing to the program you want to select (see Start and Programs). The programs knob will advance to the ‘0’ position after the program ends.

Cleaning and Maintenance

CLEAN THE FILTER AFTER EACH CYCLE

The filter is an important part of your dryer: it accumulates lint and fluff that is formed while drying. Small items could also become trapped in the filter. When finished drying, therefore, clean the filter by rinsing it under running water or with your vacuum cleaner. Should the filter become clogged up, the airflow inside the dryer will be seriously compromised: drying times lengthen and you will consume more energy. It may also damage your dryer.

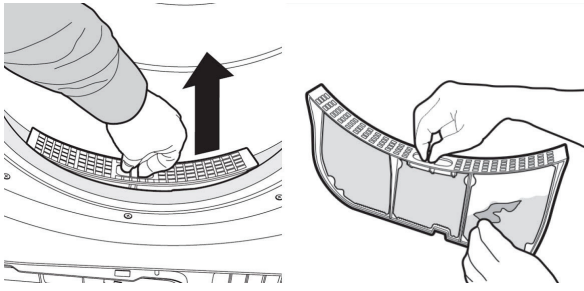

The filter is found in front of the dryer trim (see diagram).

REMOVING THE FILTER:

1. Pull the plastic grip of the filter upwards (see diagram).
2. Clean the filter and replace it correctly. Ensure the filter is fully located flush into the tumble dryer trim.

IMPORTANT

Do not use the dryer without replacing the filter.

IMPORTANT

For more information about dryer settings and available programmed drying cycles, refer to Splendide's Care, Use and Installation Booklet.

CHECK THE DRUM AFTER EACH CYCLE

Turn the drum manually in order to remove small items (handkerchiefs) that could have been left behind.

CLEANING THE DRUM

Do not use abrasives, steel wool or stainless steel cleaning agents to clean the drum.

A color film may start to appear on the stainless steel drum, this may be caused by a combination of water and, or cleaning agents such as fabric conditioner from the wash. This colored film will not affect the dryer performance.

CLEANING THE DRYER

- External parts in metal or plastic and rubber parts can be cleaned with a damp cloth.
- Periodically check the vent tube and any permanent venting fixture to make sure that there has been no accumulation of fluff or lint, and remove it.
- Remove lint that collects around the filter and the outlet vents.

IMPORTANT

Do not use solvents or abrasives. Your dryer uses special bearing components which do not need lubrication. Have your dryer checked regularly by authorized technicians to ensure electrical and mechanical safety.

Source(s): DV6400X Splendide Tumble Dryer Care, Use and Installation Booklet

Product(s): Splendide DV6400X 24-in Dryer (Model: DV6400X, Newmar Part Number: 156341)

Splendide Tumble Dryer Operation (Model: DV6500X)

This article provides basic operation instructions for a Splendide Tumble Dryer (Model: DV6500X).

Control Panel

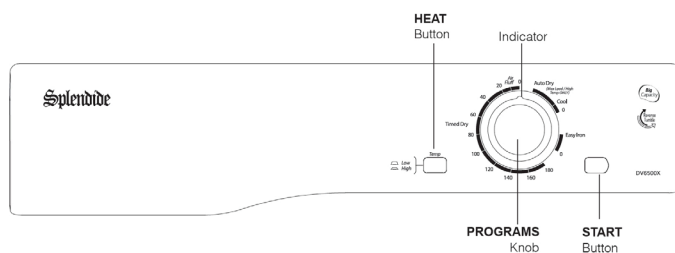

The START button begins drying a selected program.

The HEAT button selects drying temperature:

- IN: HIGH heat.
- OUT: LOW heat.

The Drying Guide allows you to consult a user friendly table of fabric types and load capacities.

The Special Programs Guide gives a guide to the available programs.

The PROGRAMS knob sets the program: rotate it clockwise, never counter-clockwise, until the indicator is pointing to the program you want to select. The programs knob will advance to the '0' position after the program ends.

CHOOSING A PROGRAM

1. Plug dryer into a grounded 3 prong outlet.
2. Sort your laundry according to fabric type.
3. Open the door and make sure the filter is clean and in place.
4. Load the machine and make sure that the items are not in the way of the door seal. Close the door.
5. Choose the drying program by checking the Programs table as well as the indications for each type of fabric. Set the temperature with the HEAT button. Select a program or drying time by rotating the PROGRAMS knob clockwise.
6. Press the START button to begin. During the drying program, you can check on your laundry and take out items that are dry while others continue drying. When you close the door again, press START in order to resume drying.
7. About 10 minutes before the program is completed, it enters the final AIR FLUFF phase (fabrics are cooled), which should always be allowed to complete.
8. Open the door, take your laundry out, clean the filter and replace it.
9. Unplug the dryer.

Laundry

SORTING YOUR LAUNDRY

- Check symbols on clothing labels to make sure that the articles can be tumble dried.
- Sort laundry by fabric type.
- Empty pockets and check buttons.
- Close zippers and hooks and tie loose belts and strings.
- Wring out each item in order to eliminate as much excess water as possible.
- Do not load dripping wet clothes into the dryer.

WHAT NOT TO TUMBLE DRY

- Articles that contain rubber or rubber-like materials or plastic film (pillows, cushions, or PVC rainwear), any other flammable objects, or objects that contain flammable substances (towels soiled with hair spray).
- Glass fibers (certain types of draperies).
- Items that have been dry cleaned.
- Items with the ITCL Code. These can be cleaned with special at-home dry cleaning products. Follow instructions completely.
- Large bulky items (quilts, sleeping bags, pillows, cushions, large bedspreads, etc.). These expand when drying and would prevent airflow through the dryer.

⚠ WARNING

No washer can completely remove oil. Do not dry anything that has ever had any type of oil on it (including cooking oils). Do not dry items containing foam, rubber, or plastic in this dryer. Doing so can result in death or fire.

⚠ WARNING

Keep flammable materials and vapors, such as gasoline, away from dryer. Do not dry anything that has ever had anything flammable on it (even after washing). Failure to follow these instructions can result in death, explosion, or fire.

MAXIMUM LOAD SIZE

Do not load more than maximum capacity. These numbers refer to dry weight:

- Natural fibres: 6 kg max (13 lb)
- Synthetic fibres: 3 kg max (6.6 lb)

Do not overload the dryer as this could result in reduced drying performance.

Cleaning & Maintenance

WHEN YOU SHOULD SWITCH OFF THE ELECTRICITY

Unplug the dryer when not using it, when cleaning it and during maintenance activities.

CLEAN THE FILTER AFTER EACH CYCLE

The filter is an important part of your dryer: it accumulates lint and fluff that is formed while drying. Small items could also become trapped in the filter. When finished drying, therefore, clean the filter by rinsing it under running water or with your vacuum cleaner. Should the filter become clogged up, the airflow inside the dryer will be seriously compromised: drying times lengthen and you will consume more energy. It may also damage your dryer.

The filter is found in front of the dryer trim.

Removing the filter:

1. Pull the plastic grip of the filter upwards (see diagram).
2. Clean the filter in all its parts, opening it and removing the lint both outside and inside.
3. Properly insert the filter back in place. Ensure the filter is fully located flush into the tumble dryer trim.

Do not use the dryer without replacing the filter.

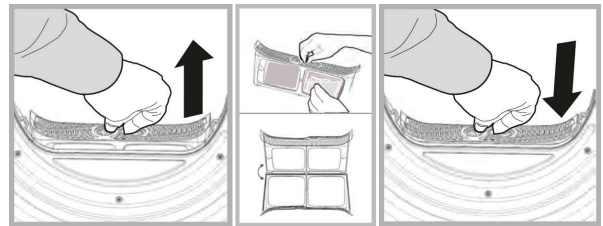

CHECK THE DRUM AFTER EACH CYCLE

Turn the drum manually in order to remove small items (handkerchiefs) that could have been left behind.

CLEANING THE DRUM

Do not use abrasives, steel wool or stainless steel cleaning agents to clean the drum.

A color film may start to appear on the stainless steel drum, this may be caused by a combination of water and, or cleaning agents such as fabric conditioner from the wash. This colored film will not affect the dryer performance.

CLEANING THE DRYER

- External parts in metal or plastic and rubber parts can be cleaned with a damp cloth.
- Periodically check the vent tube and any permanent venting fixture to make sure that there has been no accumulation of fluff or lint, and remove it.
- Remove lint that collects around the filter and the outlet vents.

Do not use solvents or abrasives.

Your dryer uses special bearing components which do not need lubrication.

Have your dryer checked regularly by authorized technicians to ensure electrical and mechanical safety.

Source(s): Splendide Tumble Dryer DV6500X Care, Use, and Installation Booklet

Product(s): Splendide DV6500X 120v Dryer (Model: DV6500X, Newmar Part Number: 162308)

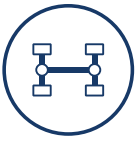

CHASSIS

This chapter provides information from your chassis manufacturer, detailed operating instructions for the fuel, leveling, and steering systems installed in your coach, as well as guidelines for proper use and maintenance of your wheels and tires.

⚠ IMPORTANT

Any of the following quick start instructions provided by Newmar should not take the place of the chassis manufacturer's complete documentation. Refer to your chassis owner's manual for information relating to vehicle identification and safety, dash instruments, controls, and switches, steering and braking systems, driver assistance features, maintenance recommendations, etc.



Spartan

Emergency Roadside Assistance

- Phone: 888.890.1741

Recreational Vehicle Owner Support

- Phone: 800.543.4277
- Web: <https://www.spartanrvchassis.com/owners/service-support/>
- Email: rvcustomerservice@spartanrvchassis.com

Chassis Manuals

Refer to Spartan's Connected Care app for all chassis-related information, including, but not limited to:

- Vehicle Identification
- Dash Instruments, Controls, and Switches
- Steering and Brake Systems
- Driver-Assistance Features
- Emergency Procedures
- Inspection and Maintenance

Material provided by Spartan RV Chassis.

Spartan e-ASK PKE Keyless Ignition Quick Start Guide

This article provides a quick start guide for a Spartan coach equipped with a push-button start ignition system (2019 model year and newer). This vehicle ignition/starting system utilizes an electronic key FOB instead of a mechanical key. The push-button switch is used to activate accessory and ignition power and to control the starting of the engine.

Key FOB (e-FOB Operation and Features)

The FOBs have typical lock/unlock buttons that can be used up to 50 meters depending on architecture and location. For security reasons, RF signals are encrypted using randomly generated numbers. This is what allows the system to start by pressing a button. The system uses the LF/RF messaging to ensure an authorized FOB is within range inside the vehicle. A combination of LF challenges and RF responses delivers low power consumption for long battery life.



Pressing a button on the FOB should cause the LED to flash multiple times. The LED will also flash anytime it is located by an antenna. This happens when you start your vehicle and the FOB search near the driver's seat is initiated. The FOB is powered by a standard 2032 3V battery.

INDICATOR LIGHT

- Flashes red when a button is pressed on the key FOB and/or when pressing the coach's brake pedal with the key FOB in range
- If the indicator light does not flash, check the key FOB's battery and replace it if necessary.

FOB FUNCTIONALITY

Button	Function
Lock All	Locks all doors
Unlock Entry	Unlocks entry doors
Lock Cargo	Locks the cargo doors in the order of section A, B, C, D
Unlock Cargo	Unlocks the cargo doors in the order of section A, B, C, D

Push Button Switch

PUSH BUTTON SWITCH OPERATIONAL FUNCTIONS

- Turn on, start, and turn off the vehicle.
- Green/amber lamp for driver feedback.



GREEN LAMP

- Indicates valid key authentication.
- Flashes three times when the key is not found.
- If the coach will not start and the indicator blinks green, hold the key FOB up to the ignition button to see if the coach starts. It may be necessary to place the key FOB on the dash while cycling the rear chassis battery disconnect for five minutes. Then turn on the coach to allow the key FOB to be re-authenticated.
- If the key FOB does not open the doors, this may be an indication of a low battery in the key FOB.



AMBER LAMP

- Indicates vehicle power is ON in ACC and IGN modes.
- Lamp is off to avoid driver annoyance while vehicle is running.
- Flashes five times to indicate an issue with the ignition system. A call for service may be required.



System Operation

TO USE IGN OR ACC MODES WITHOUT STARTING THE COACH

- Press button once to put vehicle into ACC mode.
- Press button again to put vehicle into IGN mode.
- Press button again to turn ACC and IGN mode OFF.

TO START THE ENGINE

To start a coach with keyless ignition, the key fob must be located within three or four feet of the dash START button.

1. Depress and hold service brake.
2. Authentication occurs - GREEN lamp ON.
3. Hold Button for longer than 1.5 seconds.
4. Engine cranks and starts.
5. Release button and service brake.

NOTE FROM NEWMAR

On 2019 coaches, press the brake signal override switch located next to the diagnostic connector. For more information, refer to the "Spartan Keyless Ignition Will Not Start Coach" article in Newgle.

TO TURN THE ENGINE OFF

1. Depress and hold service brake.
2. Place transmission in Neutral.
3. Press and release button.
4. Engine stops.

Standard Operating Procedure

PUSH TO START

Pressing the engine start button will begin the process of detecting a FOB in range (J11P2 active). Our system will look in the area of the driver. If the FOB is in range it will respond with a single blink. If the FOB is authorized. Our system will tell the motor that it may start.

RUNNING

Once running, the FOB is not required to keep the vehicle running.

Note: You can drive away without your FOB in the vehicle. You will not be able to start the vehicle again without the FOB.

SHUTDOWN

With your vehicle in park, a short press of the start/stop button will turn off the vehicle.

LOCKING (TYPICAL)

Press and hold the Button 1 button on the keypad or press the lock function on the FOB.

UNLOCKING ENTRANCE (TYPICAL)

Type in the five-digit code followed by the 1 button or press the unlock function on the FOB.

Note: Programming new codes into your keypad can be found in section Keypad Operation and Features (36444-03) - Section 3 under Teaching Keypad New Authority / Access Codes. This information is located within the "500-1300 Trimark Passive Keyless Entry System Instructions on Spartan Chassis AUG 2019 REV 4" file in Newgle.

AUTO LOCKING

Parking Break		Description
Engaged	Active	The parking brake is active and the vehicle cannot move. The vehicle is considered "not in use."
Disengaged	Float	The vehicle will move if no other brakes are applied. The vehicle is considered "in use." This is usually caused by putting the vehicle into gear.

AUTO-LOCK/UNLOCK

The parking brake is monitored to utilize this auto-locking feature:

- Whenever the vehicle parking brake activates, a timer is started. Seven seconds later a lock-all sequence is done.
- Whenever the vehicle parking brake activates, the entrance door is unlocked.

ALARM FUNCTIONALITY

Note: This section only applies to coaches equipped with a security package.

ARMING THE ALARM:

Performing a “lock all” with the touchpad or the key FOB will attempt to set the alarm.

The word “attempt” is used above because several conditions can block the alarm from being armed:

- Parking brake not set (in gear)
- Pressing the button to start the vehicle
- Any security inputs are in the active state
- Any door ajar inputs are in the active state

FEEDBACK:

- If you activate the alarm from the keypad, the system will send a single pulse to the headlights.
- If you activate the alarm from the FOB, the system will send a single pulse to the headlights.
- If you fail to activate, the lights will flash 3 times.

DISARMING THE ALARM:

The alarm system will immediately be disarmed if one of the following things occurs:

- You start the engine
- Any unlock signal
- The vehicle is put into gear

CANCELING THE ALARM:

Any of these conditions will cancel an active alarm:

- The vehicle is put into gear
- The engine is started
- An unlock command of any door/compartament
- The alarm timer expires

TRIPPING THE ALARM:

After arming the alarm, if the security input (J1P13) or any of the door ajar inputs are tripped, the alarm will activate. When active, the siren will go off and the headlights will flash for one minute.

NOTE FROM NEWMAR

- **Locking the coach using the key FOB automatically sets the alarm, as long as all doors are closed.**
- **Newmar does not program the alarm for an “audible chirp.” Instead, the headlights will flash once (single pulse) to indicate when the locks/alarms have been set. The headlights will flash three times (triple pulse) if the security system fails to set.**
- **If the coach is equipped with a motion sensor, it is armed with the alarm unless the motion sensor or security sensors are turned off via the switch in the dash area.**
- **If the user locks the coach via the key FOB while inside the coach and proceeds to open the entry door or walk near the motion detector while it is active, the alarm will go off.**
- **If the user wants to lock the coach without the alarm, the coach can be manually locked via the entry door’s lock assembly, the door lock switch in the dash or passenger side console area, and/or the SilverLeaf system (if equipped).**
- **If the siren/alarm is active, the alarm can be stopped while using the remote to unlock and/or activating the ignition, or by releasing the parking brake.**



Source(s): 500-1300 Trimark Passive Keyless Entry System Instructions on Spartan Chassis AUG 2019 REV 4

Product(s): This source is associated with more than one product. Refer to Newgle for more information about the product(s) offered for your coach's model year

How to Replace the TriMark Key Fob Battery for a Spartan Keyless Ignition System

This article provides step-by-step instructions for replacing a battery in a Spartan Keyless Ignition Key Fob.

To replace the key fob battery:

1. Remove the screw on back of the remote using a Phillips head screwdriver.
2. Pull or pry apart the housing.
3. Separate the elastomer.
4. Push the battery out of the battery holder, and replace it with the fresh battery.
5. Reassemble the fob.

The fob should not lose its programming after a battery change.

Spartan Valid Glass Dash Instrument Panel Quick Start Guide

This article provides a quick reference guide for the indicators and gauges on the Spartan Valid Glass Dash Instrument Panel.

Indicator Quick Reference

The Graphical Instrument Cluster (GIC) is a display device that communicates with multiple pieces of equipment on the coach.

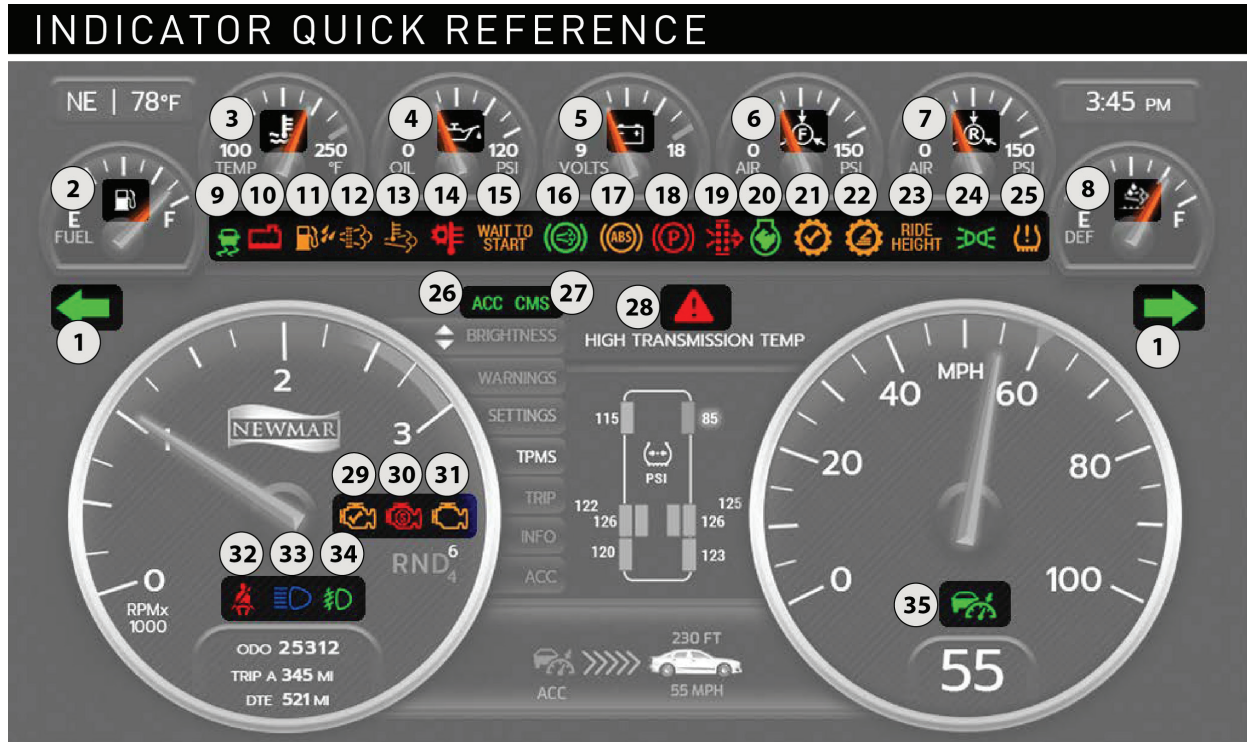

ID	ITEM	DESCRIPTION	ID	ITEM	DESCRIPTION	ID	ITEM	DESCRIPTION
1		Turn Signal	13		High Exhaust Temperature	25		Low Tire Pressure
2		Low Fuel	14		High Transmission Temp	26	ACC	Adaptive Cruise Control
3		High Coolant Temperature	15	WAIT TO START	Wait to Start	27	CMS	Collision Mitigation System
4		Low Oil Pressure	16		Auxiliary Brake	28		Information, Caution, or Critical Alarm Message
5		Low/High Battery Voltage	17		Anti-lock Braking System	29		Check Engine
6		Low Front Air Pressure	18		Park Brake On	30		Stop Engine
7		Low Rear Air Pressure	19		Restricted Air Filter	31		Malfunction Indicator Lamp
8		Low DEF	20		High Idle	32		Seatbelt Not On
9		Automatic Traction Control	21		Check Transmission	33		Headlights - High Beams
10		Low Coolant	22		Transmission Range Inhibit	34		Fog Lamps
11		Water in Fuel	23	RIDE HEIGHT	Not at Ride Height	35		Cruise Control
12		Diesel Particulate Filter	24		Marker Lights			

Gauge Quick Reference

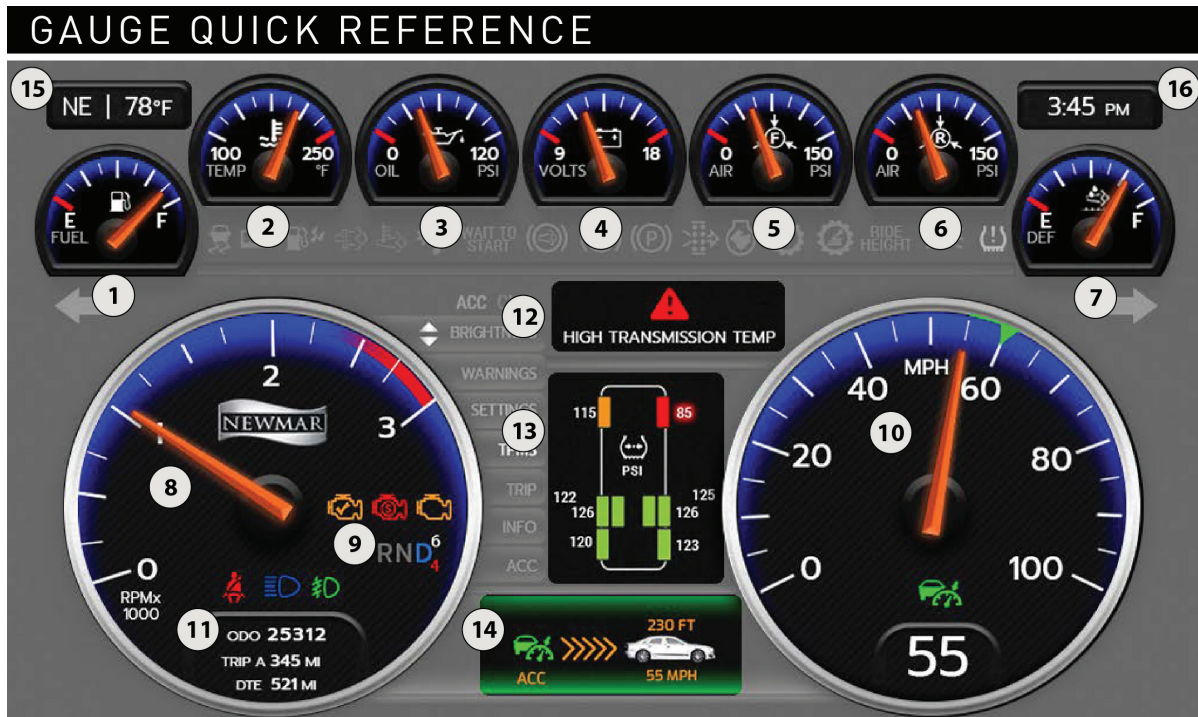

ID	DESCRIPTION
1	Fuel level
2	Engine coolant temperature
3	Oil pressure
4	Chassis battery voltage
5	Front (secondary) air brake pressure
6	Rear (primary) air brake pressure
7	Diesel Exhaust Fluid (DEF) level
8	Tachometer

ID	DESCRIPTION
9	Transmission gear
10	Speedometer
11	Trip1 or Trip 2 and odometer
12	Message center
13	Selectable display with information gauges
14	OnGuard ACTIVE collision mitigation system
15	Compass, outdoor temperature
16	Clock

NOTICE

The Valid glass dash instrument panel can be customized by Spartan and Newmar based on the model and year of coach, as well as the available standard and optional equipment. The location of gauges and icons on the instrument panel may vary from what is shown, but the operation of the instrument panel is the same.

Cleaning Your GIC Screen

The glass on the GIC screen is treated with an optical coating to prevent glare and reflection. It should be cleaned with a product that is designed for this, such as the optical wipes included with the screen, or optical cleaner and a microfiber cloth.

WARNING

The screen surface can be damaged if not treated with care.

Display and Steering Wheel Buttons

The selectable display, located in the center of the screen, is controlled by the menu tabs to the left. Move up and down the tabs by using the up and down buttons on the steering wheel control.



As you move, the display will change. Note that some items are available only when the park brake is set or the vehicle speed is 0 mph.

The buttons on the right side of the steering wheel are connection directly to the GIC.

- **Home** - go to the main screen.
- **Enter (OK)** - make a selection.
- **Back** - go back one screen.
- **Up** - scroll up in a list of selections.
- **Down** - scroll down in a list of selections.

Spartan Chassis 3-Switch Pod Steering Wheel Overview

This article provides an overview of the steering wheel, headlight controls, and wiper controls on a Spartan Chassis equipped with a 3-switch pod steering wheel and Valid Glass Dash Display. This style of steering wheel may be installed in select 2023 and newer coaches built on a Spartan Chassis.

Overview

Beginning with the 2023 model year, Spartan switched to a steering wheel with three switch pods instead of two. The steering wheel offers touch pad switch panels that allow the driver to operate a number of different functions without ever having to take their hands off of the steering wheel. It offers fingertip control of wipers, washers, Xite Infotainment center controls, and dash navigation menu controls.



#	Function	Location	Description
1	Horn	Center	The button for the horn is located in the center of the steering wheel. To sound the horn, press the center of the steering wheel pad.
2	Phone Control Function	Left Switch Pod	Steering wheel mounted control for answering, declining, and ending phone calls if a phone is paired with the vehicle's infotainment center via Bluetooth®. Select the green and red phone button for these functions.
3	Wiper High / Low	Left Switch Pod	Press to activate wipers. When initially turned on, the wipers will be at low speed. Pressing the button, a second time shifts the wipers to high speed. Every time the button is pressed, the wipers alternate between low and high speed.
4	Wiper Off	Left Switch Pod	The Off Button will turn the wipers off.
5	Wiper Wash	Left Switch Pod	Press to pump and squirt fluid onto the windshield. If pressed when the wipers are off, the wipers will complete approximately 3 cycles and then turn off again.
6	Wiper Variable Display	Left Switch Pod	If the button is pressed one time, and not pressed again within 30 seconds, the wipers will 'pulse' – completing only one cycle and repeat every 30 seconds. If the button is pressed a second time within 30 seconds, an ongoing delay wipe function will occur. The delayed time interval between wipe cycles will equal the time interval between when the button was pressed the first and second time. Initiation of any other wiper function will override the variable setting.
7	Power Telescope Column Adjustment (If equipped)	Left Switch Pod	Press down or pull up on the upper toggle to adjust column height up or down.
8	Power Tilt Column Adjustment (If equipped)	Left Switch Pod	Press down or pull up on the lower toggle to adjust tilt of column up or down.
9	Headlamp Flash	Center Switch Pod	When the headlamps are 'OFF' and this button is pressed, the headlamps will turn on for as long as the button is held. The opposite occurs if the headlamps are 'ON.'
10	Marker Lamp Flash	Center Switch Pod	When the marker lamps are 'ON' and this button is pressed, the marker lamps will turn 'OFF' for as long as the button is held. The opposite occurs if the marker lamps are 'OFF.'
11	Source	Center Switch Pod	Change the Source mode (media output) for the Xite Infotainment System.
12	Play/Pause	Center Switch Pod	Play or Pause the media output for the Xite Infotainment System.
13	Mute	Center Switch Pod	Mute the media output for the Xite Infotainment System.
14	Volume Up	Center Switch Pod	Turn up the volume for the media output for the Xite Infotainment System.
15	Volume Down	Center Switch Pod	Turn down the volume for the media output for the Xite Infotainment System.
16	Preset Back / Last Song	Center Switch Pod	Go back to the previous preset function or last song for the media output for the Xite Infotainment System.
17	Preset Forward / Next Song	Center Switch Pod	Go forward to the next preset function or song for the media output for the Xite Infotainment System.
18	Home	Right Switch Pod	Navigate through the dash menus using the control buttons on the right pod of the steering wheel. Press the HOME button to return to the menus in their original order.
19	OK	Right Switch Pod	Navigate through the dash menus using the control buttons on the right pod of the steering wheel. Press the OK button to enter the highlighted menu.
20	Arrow UP	Right Switch Pod	Navigate through the dash menus using the control buttons on the right pod of the steering wheel. Press the UP arrow to highlight a menu.
21	Arrow DOWN	Right Switch Pod	Navigate through the dash menus using the control buttons on the right pod of the steering wheel. Press the DOWN arrow to highlight a menu.

22	BACK	Right Switch Pod	Navigate through the dash menus using the control buttons on the right pod of the steering wheel. Press the BACK button to go back to the last menu that was displayed.
23	Steering Effort Adjustment / Comfort Drive	Right Switch Pod	Press down or pull up on the upper toggle to steering control efforts up or down.
24	Pedal Adjust	Right Switch Pod	Press down or pull up to move adjustable pedals forward or backward.

Left Steering Stalk



CRUISE CONTROL

CRUISE OFF/ON

To enable the Cruise Control function, move the selector switch to the ON position. To disable the Cruise Control function, move the selector switch to the OFF position.

SET CRUISE

To use the Cruise Control, move the selector switch to the ON position. To set the speed, press the button on the end of the left steering stalk. Then accelerate to the speed you want, and press the button on the end of the stalk to set the speed.

⚠ WARNING

Do not use the cruise control system when driving conditions do not permit maintaining a constant speed, such as in heavy traffic or on roads that are winding, icy, snow-covered, slippery, or roads with a loose driving surface. Failure to follow this precaution could cause a collision or loss of vehicle control, possibly resulting in personal injury or property damage.

CRUISE RESUME/ACCELERATE

If Cruise Control has been previously disengaged due to brake application, Cruise speeds can be resumed by moving the selector switch to the R/A position.

To increase Cruise Control speed while cruise is already engaged, move the selector switch to the R/A position and the cruise will accelerate to a higher set position.

To decrease Cruise Control speed while cruise is already engaged, press and hold the Set button the end of the stalk to decrease the set cruise speed.

HIGH BEAM HEADLIGHTS

With the headlight switch on, pull the stalk toward you to turn the high-beam headlights on and off.

Spartan Headlight Rotary Switch Overview

This article provides the basic positions for a rotary-style headlight switch on Spartan coaches equipped with a Valid glass dash.

Switch Positions

1. Fog lights: Activate by pulling the switch out when the marker lights or headlights are on.
2. Automatic Headlights (Optional)
3. Off
4. Marker Lights
5. Headlights



Curt Spectrum Integrated Brake Control System Operation on Spartan Chassis

This article provides basic operation instructions for a Curt Spectrum Integrated Brake Control System on a Spartan Chassis.

Modes and Indicators On LED Display

The LED display shows the output setting when the control is activated. It is used to setup and monitor the brake control and can be used when trouble shooting. There are four modes of operation and three indicator sequences.

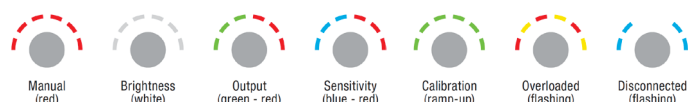

Pressing the control button switches between modes.

MANUAL CONTROL (RED PROGRESSION)

Manual brake control activation is used in situations where a slow reduction in speed is desirable. As the manual control is pushed, the brake control begins to apply the trailer brakes.

The manual control can be setup to allow 100% of the unit's power to the trailer brakes or to limit power to the output control setting. This feature is set up at installation via a small switch at the rear of the unit. The brake control unit is factory-set with the switch in the 'limited to the output control' position.

The output will be shown on the display when the manual control is actuated. Brake light activation with the manual control is also an optional setting. Some tow vehicle circuits do not allow power for brake lights from a second source. In these applications, the brake light feature can be switched off using a second small switch at the rear of the unit. The brake light connection (red wire) is still required to activate the Spectrum™ brake control with the switch in either position.

- Pressing and holding the button during any mode activates the manual brake output.
- The manual output functions as time-based and ramps up over time.
- The red LEDs light up in sequence proportionally to the brake output.
- Adjust the gain in active process by rotating the knob clockwise to increase and counter-clockwise to decrease the gain while holding the button down.
- Releasing the button returns to the previous mode.

BRIGHTNESS CONTROL (WHITE PROGRESSION)

- Default control state
- Rotating the knob clockwise will increase the brightness.
- Rotating the knob counter-clockwise will decrease the brightness.

OUTPUT CONTROL (GREEN TO RED PROGRESSION)

The output control establishes the maximum amount of power available to the trailer brakes when braking. The only exception would be when the manual control is set up for 100% braking.

The output control can be adjusted during initial setup, when trailer load changes, when different trailers are used or when adjustment is needed for changing road or driving conditions.

- Rotating the knob clockwise increases braking output.
- Rotating the knob counter-clockwise decreases the braking output.
- Green represent lowest setting and red represent the highest setting.

- After 10 seconds of no user input, the interface switches to brightness mode and the display goes to sleep.
- Pressing and holding down the button activates manual control.

SENSITIVITY CONTROL (BLUE TO RED PROGRESSION)

The sensitivity control adjusts trailer brake aggressiveness. Sensitivity adjustment has no effect on the manual control. The sensitivity control can be adjusted for individual driver preference, trailer load changes or changing road conditions.

- Rotating the knob clockwise increases sensitivity.
- Rotating the knob counter-clockwise decreases sensitivity.
- Blue represents the lowest setting, while red represent the highest setting.
- After 10 seconds of no user input, the interface switches to brightness mode and the display goes to sleep.

CALIBRATION INDICATOR (RAMP-UP)

- Indicates when the brake control is self-calibrating.
- Occurs when power is applied to the brake control and a trailer is connected.
- The knob lights up green in clockwise sequence seven times.

OVERLOAD INDICATOR (RED AND YELLOW FLASHING)

- Indicates when the brake control is in an overload or short-circuit condition.
- The LEDs flash red and yellow in sequence until the overload condition is removed.

DISCONNECTED INDICATOR (BLUE FLASHING)

- Indicates when the trailer has been disconnected (flashing) or if the brakes are pressed with no trailer connected (steady on as long as brake pedal is held).

Test Drive and Adjustment

Both the output and sensitivity can be adjusted to achieve smooth, firm stops. Output and sensitivity adjustments should only be made while stopped, with the transmission in park or neutral, parking brake applied, foot off the brake pedal, and no manual control actuation. Output and sensitivity settings will be lit a few seconds after the adjustments are made and will then go into brightness mode.

Starting with the output adjustment, drive forward on a dry and level paved or concrete surface. At approximately 25 mph, apply the vehicle's brakes. If trailer braking is insufficient, adjust the output control by rotating the LED display knob clockwise. If the trailer brakes lock up, adjust the output control by rotating the knob counter-clockwise. Repeat this process until stops are firm, just short of lock up.

Once the output is set, adjust the sensitivity by driving forward at approximately 25 mph and press the brake pedal. The vehicle and trailer should make a smooth stop. If the stop seems slow and more aggressive braking is desired, adjust the sensitivity level by rotating the LED display knob clockwise. If the stop seems too aggressive, adjust the sensitivity level by rotating the knob counter-clockwise.

Make several stops at various speeds and adjust the sensitivity until stops are smooth and firm. Slight adjustment to the output control may also be desirable. For more information, refer to the Curt Spectrum Brake Controller Manual in Newgle.

Recommended Tow Procedures For Motorhomes Built On Spartan Chassis

Provides the recommended tow procedures provided to Newmar by Spartan Motors Chassis, Inc. in August 2017.

COACH INFORMATION

- Gross Vehicle Weight Rating (GVWR)
- Gross Axle Weight Rating Front (GAWRF)
- Overall height of vehicle at ride height (includes A/C, satellite, etc.)
- Overall length of vehicle
- Front overhang measurement (center front wheel to front of coach)
- Ground to coach body measurement at front tire
- Type of front suspension (straight axle or IFS)
- Steer axle tire size
- Is coach capable of holding air?

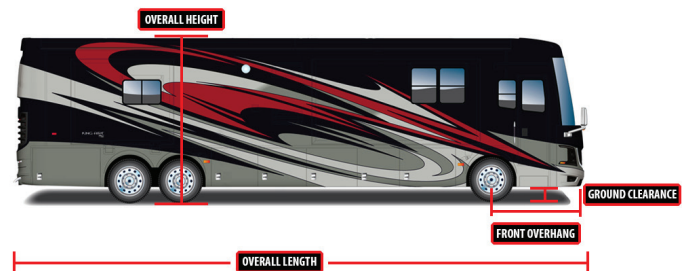

Towing Information

FLAT BED OR LOW BOY

- Typically only used in heavy damage or complete air failures
- Verify approach angle to load vehicle will not damage body throughout loading process
- Remove rear stone guard before loading vehicle
- Measure total height of coach once loaded onto trailer

TOW TRUCK

- Wheel lift is preferred but frame/cradle lift is acceptable
- ALWAYS tow vehicle from the front
- Remove rear stone guard before loading vehicle
- Verify air suspension will hold air (never tow vehicle with air springs deflated)
- Verify front tow mounting will not damage other vehicle components

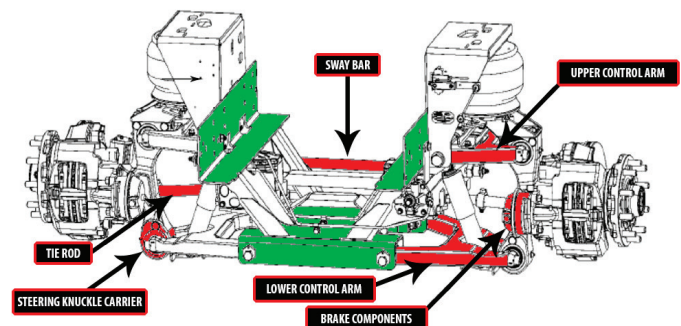
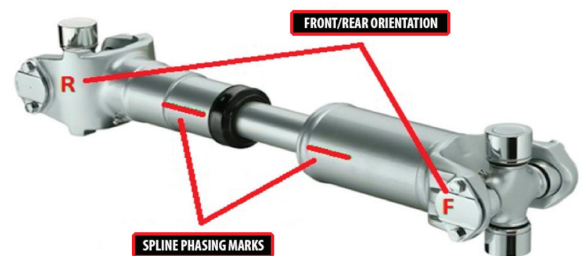

The chassis frame and suspension cradle (shown in green) are the proper lift points for towing.

- Drive shaft must be completely removed before towing
- The driveshaft must be marked for spline phasing and front/rear orientation before removal.
- Provide auxiliary air source from tow truck to vehicle being towed
- Verify parking brakes will stay released, if not, the spring brakes will need to be caged
- Ignition switch in vehicle must be in OFF position while towing
- Re-install drive shaft using marks made during removal, install new straps and torque bolts
- ¼ -28 = 13-18 ft.lbs., 5/16 -24= 30-35 ft.lbs., 3/8 – 24=45-60 ft.lbs., ½ -20=115-135 ft.lbs.

⚠ WARNING

Do not attach tow apparatus (Hooks, Chains, Straps, etc.) to suspension upper and lower control arms, sway arms, sway brackets, brake components, tie rods, steering arms, or steering knuckle carrier assemblies.

⚠ NOTICE

DISCLAIMER: In no event shall Spartan Motors be responsible or liable for any claim, loss or damage of any kind whatsoever, whether or not foreseeable, suffered as a result of towing a vehicle. Nothing contained herein shall operate as an assumption of any risk on the part of Spartan Motors relating to towing of a vehicle.



Collision Warning Systems

Optional Safety Cruise collision avoidance systems will help you navigate safely through adverse weather and detect potential blind spot hazards, warning you of potentially dangerous driving conditions or situations.



Mobileye Collision Warning System Operation (Model: 6 Series)

This article provides basic operation instructions for the optional Mobileye Collision Warning System (Model: 6 Series).

Quick Reference Guide

Some of these settings may be locked.

FEATURE	IMAGE	EXPLANATION	ADJUSTMENT
Forward Collision Warning Urban Forward Collision Warning		Red vehicle icon warns of an imminent rear-end collision up to 2.7 seconds before. Active at any speed. Same red vehicle icon warns of a possible low speed collision, under 19 MPH. This alert is differentiated from the FCW by the sound of the alert. UFCW alerts with a double-beep vs. FCW which alerts with a series of beeps. This feature acts as a virtual bumper as well.	This alert cannot be adjusted, disabled or muted. If system is turned off, no warnings will be issued.
Lane Departure Warning		Alerts when vehicle departs from driving lane without turn signals. Yellow lane icon appears when not active, white lane icon appears when active. Displays both lanes at all times. Dashed lane marking for departure side. Active above 40 MPH Newmar Note: On select models, a haptic feedback feature will vibrate the seat to alert the driver.	To Adjust Mobileye System, please refer to settings menus. 0 =OFF; 1 =ON
Headway Monitoring and Warning		Displays the amount of time, in seconds, to the vehicle in front when that time becomes 2.5 seconds or less. Green vehicle icon signifies safe headway; icon becomes red when headway time is 0.6 seconds or less. Note: If numbers appear dim that is an indication of low visibility conditions (bad weather, direct sunlight, dirt on windshield, etc.). System continues to work but there may be diminished detection ability.	To Adjust Mobileye System, please refer to settings menus Available levels: 0.1-2.5 seconds.
Pedestrian Collision Warning Pedestrian Detection Warning		Red pedestrian icon warns of an imminent collision with a pedestrian or bicyclist. Operational during daylight hours only. Active under 31 MPH. Green pedestrian icon appears in area defined as the "Danger Zone". Time to collision is not critical, no audio alert.	This alert cannot be adjusted or disabled.

Intelligent High-Beam Control (Optional)		Automatically turns the high-beams on/off depending upon the level of light and relative distance from other traffic. Green icon signifies the control is enabled. Blue icon signifies the feature is active. Active above 21 MPH.	To adjust Mobileye System, please refer to settings menus. 0 = OFF; 1 = ON
Speed Limit Sign (Optional)		Speed Limit Sign flashes when vehicle exceeds speed limit. Detected speed limit sign is shown as a large icon for one second, then minimizes and is shown as last posted speed sign. Vehicle's current speed can be displayed in upper right hand corner (optional feature). Last known Speed Limit Sign can be displayed in upper left hand corner (optional feature).	To adjust Mobileye System, please refer to settings menus There are 6 available levels.

NOTE FROM NEWMAR

Depending on the coach model and year, this information may be displayed on Mobileye's round remote monitor or integrated into the Xite Infotainment and/or chassis digital dashboard.

For more information, contact Mobileye at (877) 867-4900.

Source(s): XiteSolutions Mobileye Quick Reference Guide (V. 20190122.01)

Product(s): This source is associated with more than one product. Refer to Newgle for more information about the product(s) offered for your coach's model year.

Meritor Wabco OnGuardACTIVE Collision Mitigation System Operation

This article provides brief operation instructions for a Meritor Wabco OnGuardACTIVE Collision Mitigation System.

Overview

WABCO's OnGuard ACTIVE is a radar-based active safety system that offers Adaptive Cruise Control, Forward Collision Warning, and Collision Mitigation. OnGuard ACTIVE detects objects ahead and measures the vehicle's position and speed in relation to other vehicles on the road to warn the driver of a possible collision by providing audible, visual, and haptic warnings. The system will apply the brakes to reduce the risks and severity of rear-end collisions.

OnGuard ACTIVE is not intended to replace driver control of the vehicle at any time. You, as the driver, remain in control of your vehicle and determine the actions that are necessary for safe operation.

Adaptive Cruise Control

Adaptive Cruise Control (ACC) automatically adjusts the speed of your vehicle while in cruise control and attempts to maintain a set following an interval of 3.6 seconds when there is a vehicle ahead. ACC works with conventional cruise control to maintain the set cruise speed when the lane ahead is clear and will automatically adjust the vehicle's speed to maintain the set following interval when a vehicle ahead is detected.

Collision Mitigation System

OnGuard ACTIVE's Collision Mitigation System (CMS) assists the driver in recognizing and responding to dangerous driving scenarios that could lead to a rear-end collision. The system responds by sending warnings, automatically reducing engine torque, and applying foundation brakes. OnGuard ACTIVE's CMS provides both visual and audible alerts through an in-cab dash display. If a potential collision is developing and the driver does not take action to decelerate the vehicle, OnGuard ACTIVE's active braking feature issues a haptic warning (short brake pulse) and automatically de-throttles the engine. If a potential collision still exists, and the driver still has not taken the appropriate action, OnGuard ACTIVE's CMS will apply the foundation brakes. When OnGuard ACTIVE applies your vehicle's brakes, your brake lights will come on.

The active braking application is intended to assist the driver to avoid or reduce the severity of a rear-end collision. The driver must take the appropriate corrective action in response to the collision warning. OnGuard ACTIVE warnings will not be issued below a vehicle speed of 15 mph.

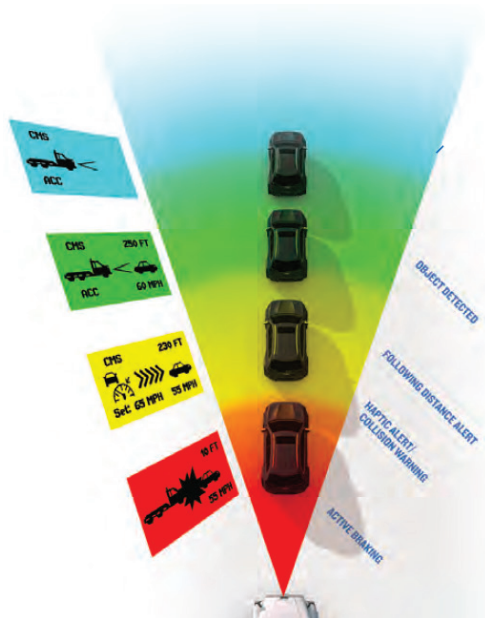

Safe Vehicle Operation

Multiple factors can affect set following intervals and create additional driving considerations. When operating a vehicle with the OnGuard ACTIVE Collision Mitigation System, it is important to remember:

- OnGuard ACTIVE should only be considered as an aid and is not intended to replace driver control over the vehicle at any time.
- Like cruise control in general, ACC should not be used when weather, road surface or conditions require longer following intervals and your full control over the speed of the vehicle. Such conditions may include: snow, sleet, rain, fog, icing, etc.
- When operating your vehicle, always use safe driving techniques. The driver is always the most important element in safe vehicle operation.
- OnGuard ACTIVE is only intended to assist reaction and response time. OnGuard ACTIVE is not a substitute for proper driver braking and should be considered only as a driver assistance system.

⚠ WARNING

OnGuard is designed to create high vehicle deceleration (without driver intervention) in certain situations. To reduce the risk of injuries caused during OnGuard-activated vehicle deceleration, all vehicle occupants should be correctly seated and properly belted or restrained during vehicle operation. All loose items should be secured so that they will not fly forward and cause injury during a deceleration event. The use of OnGuard in vehicles not equipped with seat belts may expose non-belted passengers to injuries due to system-initiated sudden vehicle deceleration, despite vehicle compliance with applicable safety standards.

Unintended Events

The OnGuard ACTIVE collision mitigation system is engineered to prevent and/or mitigate as many accidents as possible. Radar technology is not perfect; in every system it is possible that an unintended braking event may occur.

In the rare event that you experience a false alert, or unintended braking event, you may experience the following sequence of events:

- Less than 0.4 seconds of braking.
- The truck and trailer brake lights will illuminate.
- Your OnGuard ACTIVE display screen will change to a collision warning (red).
- Your OnGuard ACTIVE display screen will change to a collision warning (red) and issue a short audible warning.
- If you do not have ACC engaged, you can apply the throttle and continue on your way.

- If ACC is engaged, depending on your vehicle configuration, you may have to simply reapply the cruise control button or turn ACC off and back on again. It is possible that you may lose the ability to throttle the vehicle for a short time (a couple of seconds).

System Limitations

The OnGuard ACTIVE CMS brakes for moving and stationary objects located directly in front of your vehicle and does not operate when your speed is less than 15 mph or over 77 mph. Accordingly, OnGuard ACTIVE:

- Will not react and alert you to objects crossing in front of you or oncoming traffic.
- Should not be relied on to track lead vehicles when traveling through a severe curve or winding road.
- Should not be relied upon to track smaller objects (e.g. motorcycles, mopeds, bicycles, pedestrians, etc.)
- Should not be relied on to alert drivers to vehicles in an adjacent lane.

Drivers should take into account the road conditions, and any other factors they are encountering, as they choose how to react to any alerts they receive from the OnGuard ACTIVE system.

Source(s): OnGuard Active Collision Mitigation System Driver Tips

Product(s): This source is associated with more than one product. Refer to Newgle for more information about the product(s) offered for your coach's model year.

Blockage Detection

The sensor can detect whether it is blocked based on the number of objects present. This can be caused by snow, ice, heavy rain, or even a bull bar in front of the vehicle. If a blockage is detected, the radar will output a corresponding fault code. This fault code remains active until the radar successfully detects a clear field of view again. Switching the ignition off and on does not delete this fault code.

Blocking detection only works while the vehicle is in motion, i.e. during a standstill a blockage is not identified and a corresponding activation fault is not reset. There are two different types of blockage:

- complete blockage, i. e. the radar sensor does not detect any object at all
- a reduced detection range, i.e. the radar loses almost all objects in short distances (this can be caused by heavy rain or snowfall, for example)

Detection of a complete blockage takes 2 minutes while driving at speeds above 20 km/h. A blockage caused by a range reduction due to bad weather conditions (snow, rain) can take longer depending on the conditions.

Driving in areas without traffic ahead and almost without objects at the roadside (e.g. desert-like regions) can also lead to a blocking error because the radar does not detect any objects.

Source(s): OnGuard Active System Description Version 1 (08.2017)

Product(s): This source is associated with more than one product. Refer to Newgle for more information about the product(s) offered for your coach's model year.

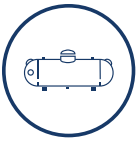

Fuel Systems

This section provides information about the fuel systems in your coach, including LP (if equipped), chassis engine fuel, and auxiliary fuel tanks (if equipped).

Chassis Diesel Engine Fuel

This article provides information regarding the chassis diesel engine fuel, fuel filler cap, and the refueling process.

IMPORTANT

Consult your chassis manufacturer information about your recommended fuel and fuel blends, additives, and maintenance requirements.

WARNING

CALIFORNIA Proposition 65: Breathing diesel engine exhaust exposes you to chemicals known to the State of California to cause cancer and birth defects or other reproductive harm.

- Always start and operate the engine in a well-ventilated area.
- If in an enclosed area, vent the exhaust to the outside.
- Do not modify or tamper with the exhaust system.
- Do not idle the engine except as necessary.

For more information go to www.P65warnings.ca.gov/diesel.

DANGER

All pilot lights, appliances, and their igniters (see operating instructions) shall be turned off before refueling of motor fuel tanks and/or propane containers. Can cause ignition of flammable vapors, which can lead to a fire or explosion and result in death or serious injury.

WARNING

Never fill fuel tanks to more than 95 percent of their liquid capacity. This could make them more likely to rupture from impact possibly causing fire and resulting in serious personal injury and death by burning. Do not mix gasoline or alcohol with diesel fuel. This mixture could cause an explosion, possibly resulting in serious personal injury or death. Do not fill the fuel tanks in the presence of sparks, open flames, or intense heat. These could ignite the fuel, possibly causing severe burns.

Refueling/Filling The Tank

The fuel gauge indicates the amount of fuel remaining in the fuel tank. Avoid running out of fuel.

When fueling your vehicle:

1. Put your vehicle in park (P).
2. Switch the engine off.
3. Remove the fuel cap by rotating it in a counterclockwise motion until it spins off.
4. Pull to remove the cap.
5. Select the proper grade of fuel as specified by the engine manufacturer and fill.
 - Reminder: For coaches requiring diesel exhaust fluid (DEF), check the DEF level each time the coach is refueled.



Diesel Exhaust Fluid (DEF) Overview for Class A Diesel Coaches

This article provides an overview about the DEF tank installed on a Class A diesel coach. Diesel exhaust fluid (DEF) is designed for use in diesel engine emissions systems and helps protect the environment from harmful contaminants.

The DEF tank will require filling a minimum of approximately every second diesel refuel depending on the DEF tank capacity. 10, 13, and 15-gallon tank capacities are available. To find out the tank capacity of a coach, please contact the chassis manufacturer, as Newmar does not have this information available.

DEF consumption is approximately 2% of fuel consumption, dependent on vehicle operation. For every 50 gallons of diesel fuel consumed, approximately 1 gallon of DEF will be consumed.

Some vehicles are equipped with a remote DEF fill-port. If so equipped, the remote port is directly opposite the DEF tank on the other side of the vehicle, and has a blue cap over the fill-port. DEF parts, such as the fill cap or tank, are supplied by the chassis manufacturer and are not available via the Newmar Parts Department.

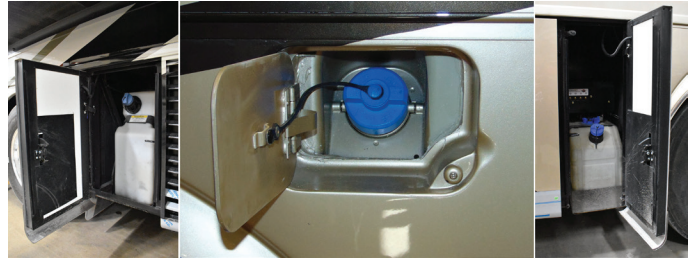

⚠ IMPORTANT
DEF consumption varies depending on ambient conditions and vehicle application.

Auxiliary Compressed Air Fitting on Diesel Pusher Coaches

This article provides an operational overview of the coach's air system connection on a diesel pusher coach.

Rear Air Fitting Overview

An auxiliary compressed air fitting is supplied at the rear of the coach in the engine compartment on select diesel pusher coaches. This connection can be used to either inflate the air system from an outside source (such as a shop air compressor) or to use the coach's air system and a hose to inflate floats, bike tires, or car tires. If necessary, the compressor can be used to inflate a coach tire in an emergency when other sources of compressed air are unavailable; however, it will take some time due to low air pressure.

When using air from the connection, the engine should be running to operate the compressor. The air pressure is regulated by the air governor for the chassis air system. The approximate pressure can be monitored by the gauges on the dash. The air connections are supplied and plumbed by the chassis manufacturer.

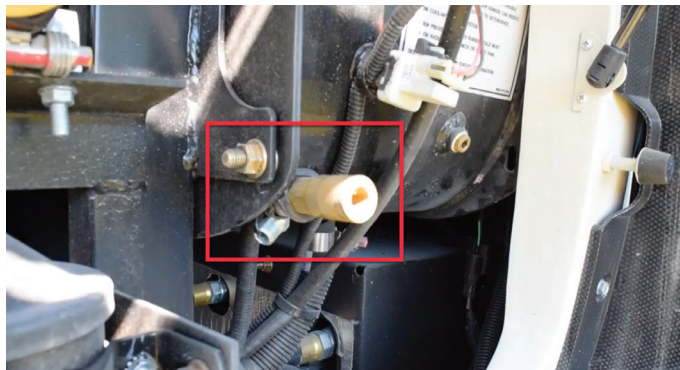

⚠ NOTICE
You may not have enough air pressure to properly inflate tires, but you should be able to get enough to drive to the nearest tire service center.

Front Air Fitting Overview

Many coaches also have a connection at the front of the coach under the hood near the generator on the driver side. This connection (on some coaches) will only allow air pressure to be used as a customer connection for external use and will not allow compressed air to enter the system. Coaches plumbed in this manner will have an additional Schrader valve port to allow pressurization during production.

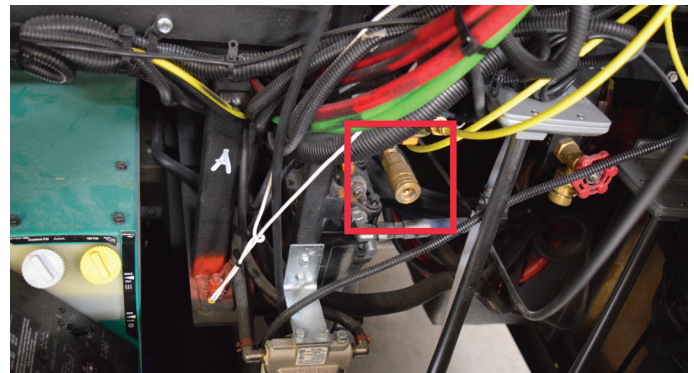
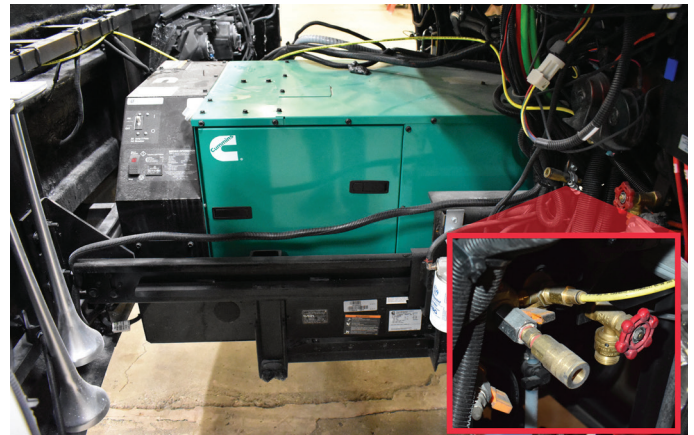



Leveling Systems

This section has information about air, electric, and hydraulic leveling systems. Due to a very wide range of operation procedures, refer to the information under the brand and model that applies to your coach.

⚠ WARNING

Do not lift the wheels off of the ground while leveling the coach. The vehicle may drop and/or move forward or backward without warning, which may cause serious injury or death.

⚠ WARNING

Never attempt to move the unit with the leveling jacks deployed. Always visually inspect the jacks prior to moving to ensure they are fully retracted, are in the stored position, and the system is turned OFF.

⚠ WARNING

Never operate any leveling system with a person or pet under the unit. Serious injury or death may result!

⚠ WARNING

Be sure the ground on which you are parked will support the weight of your unit. Often material that seems “safe” to level on will not support the weight at the leveling jack points. Use caution when leveling on hot asphalt, sand, and grass, as the weight of the unit may cause the jacks to sink into the ground. Pads may need to be placed under the jacks to spread the weight over a larger area. Always look under your unit prior to leveling to make sure the jacks are clear of debris and other foreign materials that may interfere with leveling.

Care and Maintenance

⚠ IMPORTANT

The leveling system should be cycled at least once a month to keep the system in operating condition.

Leveling and Full Wall Slideout Sequence of Operation

This article provides step-by-step instructions for leveling the coach and operating the slideouts.

⚠ IMPORTANT

In the past, Newmar has recommended leveling the coach prior to deploying the slideouts. As of 2015, Newmar makes the following recommendation for the extension and retracting of slideouts.

Motorhomes, like all vehicles, flex in travel. Flexing may be different due to terrain and the coach’s fulcrums (resting on tires or jacks). As the coach flexes, this movement is more noticeable in the outside reveal on a wider slideout.

Extending The Slideouts and Leveling The Coach

1. Park the coach on a reasonably level campsite.
2. Leave the coach at ride-height with air in the air bags (if equipped with air suspension) or on normal suspension (coaches without air suspension).
3. Plug the coach into shore power (if available) or start the generator to increase the voltage for better slideout operation.



4. Look at the “reveal” or “gap” of the two vertical wall trims around the slideouts to make sure there is plenty of clearance so the trim will not rub when extending the slideout. If the gap looks good, then the slideout can be operated.
 - **Note: Most often the gap will look best when sitting on the tires with the air suspension inflated (at ride-height), and not on the jacks.**
5. Verify that the path of the slideout is unobstructed and free from any surrounding objects, both inside and outside of the coach.
6. Once the appropriate conditions are met, follow the operating instructions posted in your coach to extend the slideouts (image for example only).

⚠ IMPORTANT

In the unlikely occasion that the slideout trim has inadequate clearances, try leveling or repositioning the coach and rechecking the clearances before extending the slideout.

7. Dump the air suspension (if equipped). This step is included in the auto-leveling process for most coaches.
8. Deploy the leveling jacks.

Retracting The Jacks and Slideouts

1. Retract the leveling jacks.
2. Start the coach.
3. Allow the coach air suspension to fill and return to ride height (units without air suspension will return to normal suspension).
4. Turn the engine off.
5. Verify that the path of the slideout is unobstructed and free from any surrounding objects, both inside and outside of the coach. This includes any water or debris that may have collected on the slideout roof or the topper awning.

6. For a full wall slideout, visually inspect the front vertical trim for adequate clearance prior to complete retraction (when the slideout trim spacing can be observed). The spacing should look even from top to bottom (see image for reference).

⚠ IMPORTANT
Debris left on the roof or topper may prevent the slideout from sealing properly when retracted, as well as prevent the mechanical lock arms from closing properly when the slideout is extended.

7. Retract the slideouts. Inspect all slideouts for complete retraction.
8. If the coach is equipped with manual lock arms, make sure to lock them.
9. Unplug the coach from shore power when you are ready to depart.

⚠ IMPORTANT
In the unlikely occasion that the slideout trim has inadequate clearances, try leveling, or if necessary, repositioning the coach, and rechecking the clearances before fully retracting the slideout.

HWH Leveling System Operation (Model: 725 Series)

This article provides step-by-step instructions for operating an HWH computer-controlled leveling system (Model: 725 Series).

⚠ IMPORTANT
It is important to allow the HWH leveling system to run the complete cycle and turn itself off when operating in store mode. The system will completely retract the jacks and turn itself off. If the system is turned off prior to the automatic shut off, there is a chance the jacks have not fully retracted. Also, visually inspect the jacks prior to departure to ensure they have fully retracted and the underside of your unit is ready for travel.

CONTROL BUTTONS	
Cancel	Push this button to stop any leveling system operation.
Auto Level	Push this button any time to start the automatic leveling function.
Auto Store	Push this button to retract all four jacks at the same time.
Manual Dump	This is a manual button for dumping air from the vehicle suspension.
Extend (UP Arrows)	These buttons will extend their respective jack pairs to lift the vehicle.
Retract (DOWN Arrows)	These buttons will retract their respective jack pairs to lower the vehicle.
INDICATOR LIGHTS	
Auto Level Indicator Light	This light will flash during the automatic leveling function.
Store Indicator Light	This light will flash during the automatic store function.
Excess Slope Light	This indicator will light when the leveling system cannot level the vehicle.
Leveling Lights	The four yellow indicating lights are level sensing indicators. When a yellow light is on, it indicates that its side, end, or corner of the vehicle is low. No more than two lights should be on at the same time. When all four yellow LEVEL lights are out, the vehicle is level.
Warning Lights	The four red lights surrounding the yellow level indicators are jacks down WARNING lights. They are functional only when the ignition is in the "ON" or "ACC" position, the system is on, and the jacks are extended approximately 1 inch.
Not in Park/Brake Light	This indicator will light when the hand/auto brake is not set and the "AUTO LEVEL" button is being pushed.
Travel Mode Light	This indicator light will be on when the ignition is on, when the jacks are retracted, and there are no red WARNING lights on.
Master Jacks Down Warning Light	This is a light mounted in the dash separate from the touch panel. It will be on when any one or more jacks are extended and the ignition is "ON".
Buzzer	This is a jacks down warning. It will sound if the master "JACKS DOWN" warning light is on.

Control Functions

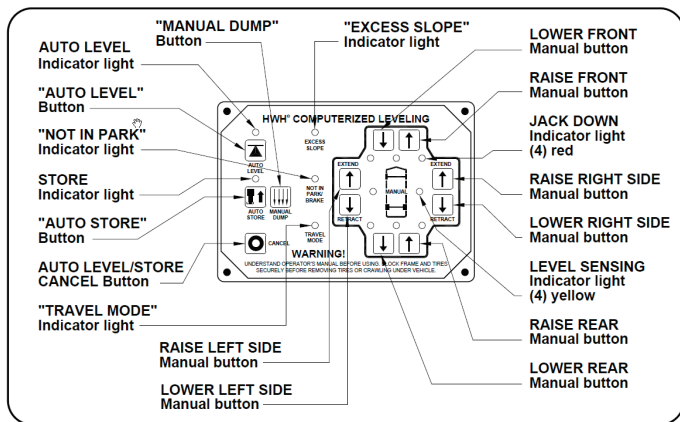

NOTE FROM NEWMAR

The jacks will operate with the key in the ACC or ON position; however, the alarm buzzer will sound if the jacks are down while the key is left in the ON position.

Version MP24.3151, 17FEB21

General Instructions

Maintain adequate clearance in all directions for vehicle, room extensions, awnings, doors, steps, etc. Vehicle may move in any direction due to jacks extending or retracting, settling of the jacks or the vehicle, equipment malfunction, etc.

If parking on soft ground or asphalt paving, a wood block or pad should be placed under each jack.

Press the “Cancel” button or turn the ignition switch “Off” at any time to stop the operation of the system.

Any time a hydraulic leveling process is interrupted, it is recommended to retract the jacks according to the jack retraction section and then restart the leveling process.

If the hand/auto brake is not set when the “Auto Level” button is pressed, the “Not in Park/Brake” light will come on. When the “Auto Level” button is released the “Not in Park/Brake” light will go out. The Automatic Leveling function will not start.

Version MP34.0232, 07AUG13

Preparation For Travel

IMPORTANT

Before traveling, the red jack warning lights must be off, the “Travel Mode” light must be on, and the vehicle should be at the proper height for travel. If lights are not correct for travel, retract jack as described in the Jack Retraction section.

If the jacks are retracted but a red “Warning” light is lit, the system needs to be serviced.

Any room extension or generator slide should be fully retracted before traveling.

WARNING

Do not move the vehicle while the leveling jacks are still in contact with the ground or in the extend position. This vehicle is equipped with straight-acting jacks. Moving the vehicle with the leveling jacks extended can cause severe damage to the jacks and/or the vehicle AND create a driving hazard. Do not rely solely upon warning lights. It is the operator’s responsibility to check that all jacks are fully retracted into the store/travel position and the vehicle is at the proper ride height for traveling. Contact [Newmar] service before moving a vehicle that is not at proper travel height

If the jacks cannot be retracted according to the Jack Retraction section, retract the jacks according to the Manual Jack Retraction section. The system should then be checked.

NOTICE

If the vehicle is parked or stored with the jacks extended for an extended period of time and the jacks fail to retract completely, extend the jacks back down to the ground then retract the jacks again.

Version MP34.0232, 07AUG13

Automatic Hydraulic Leveling Operation (HWH Touch Panel Controls)

1. Place transmission in the recommended position for parking the vehicle and set parking brake. Turn the coach engine off. Turn the ignition to the “Accessory” position.

NOTICE

One or two yellow level indicator lights on the leveling system touch panel can be on anytime the vehicle ignition is in the ‘On’ or ‘Accessory’ position and the park brake is set.

2. At this time, the operator may want to check the jacks and place a pad under each jack if the ground will not support the vehicle.

WARNING

Prior to pushing the ‘Auto Level’ button, the operator must be sure that all persons and objects are clear of the vehicle. Air will be exhausted from the vehicle suspension and the vehicle will lower immediately after the ‘Auto Level’ button is pushed.

3. Press the “Auto Level” button one time. After selecting a reasonably level site and making [sure the] site will support unit weight on jacks, the Auto Level light will start to flash. The system will begin to dump air from the vehicle suspension. After approximately 25 seconds, the leveling process will begin.

IMPORTANT

During the Automatic Leveling procedures, pushing the ‘Auto Level’, ‘Auto Store,’ or the ‘Cancel’ button on the HWH touch panel will stop the automatic leveling function.

When a jack extends approximately 1 inch, its individual red warning light on the touch panel will come on. The touch panel “Travel Mode” light will go out. If the ignition is in the ON position, the warning buzzer will sound.

AUTO LEVEL SEQUENCE

During the automatic leveling sequence, after the system has extended the appropriate jacks to level the vehicle and has turned the yellow level indicator lights off, the system will then stabilize the vehicle.

⚠ NOTICE

The slight lift experienced during the stabilizing procedure normally is not sufficient to cause a level issue for the motor home.

EXCESS SLOPE SITUATION

In the event the jacks are unable to level the coach, the “Excess Slope” light will come on. Excess slope is when one or two jacks extend fully without turning the yellow level light out. The system will not stabilize the vehicle if the Excess Slope light comes on. One or more jacks may not be extended. The system will shut off, leaving the Excess Slope light on. The Excess Slope light will remain on for two minutes if the ignition is in the “On” or “Acc” position.

Retract the jacks and move the vehicle to a more level position or level the vehicle as close as possible according to the Manual Hydraulic Operation section. The Auto Store button will function if the Excess Slope light is on. The manual Up and Down arrow buttons will function with the Excess Slope light on. The Auto Level button will not function if the Excess Slope light is on.

AUTOMATIC JACK RETRACTION

Start the engine and press the “Auto Store” button. The store indicator light will flash. The vehicle should start to return to proper ride height. The front jacks will retract for 5 seconds before the rear jacks will begin to retract. As each jack retracts, its red “Warning” light will go out. The system will automatically shut down 1 minute after the four individual red “Warning” lights are out.

⚠ WARNING

Do not move the vehicle while the leveling jacks are still in contact with the ground or in the extend position. This vehicle is equipped with straight-acting jacks. Moving the vehicle with the leveling jacks extended can cause severe damage to the jacks and/or the vehicle and create a driving hazard. Do not rely solely upon warning lights. It is the operator’s responsibility to check that all jacks are fully retracted into the store/travel position and the vehicle is at the proper ride height.

The vehicle can be moved as soon as the red warning lights are out, the jacks are in the Store/Travel position and the green “Travel” light is on, if the vehicle is at the proper ride height for traveling.

⚠ IMPORTANT

If a red warning light and buzzer come on while traveling, the jacks should be checked as soon as a safe parking location is found.

Version MP34.2751 06OCT20

Manual Hydraulic Operation

Place transmission in the recommended position for parking the vehicle, and set the parking brake. Turn the ignition to the “Accessory” position.

Place pads under the jack feet if the ground will not support the vehicle on the jacks.

Push the “Dump” button. Wait until all air is exhausted from the vehicle suspension.

The vehicle may be leveled using the manual Extend (up arrow) buttons on the right half of the panel. If a yellow Level Sensing light is on, that side, end, or corner of the vehicle is low. It is best to level the vehicle side to side first, if needed, before front to rear.

⚠ NOTICE

Jacks will extend (or retract) in pairs to raise (or lower) a side or end of the vehicle. Any jack not used for leveling can be extended to the ground. This provides additional stability against wind and activity in the vehicle. Jacks used to stabilize the vehicle after leveling is complete should lift the vehicle slightly after touching the ground.

⚠ IMPORTANT

Do not continue to push an Extend button for more than ten (10) seconds after that pair of jacks are fully extended.

When leveling is completed, turn the ignition switch to the “Off” position.

Version MP34.333 07AUG13

Maintenance

OIL LEVEL

All maintenance should be done as part of the normal servicing of the coach.

The oil level should be checked when the vehicle is first purchased and then once every two years. More often if there is an oil leak in the system.

Any HWH hydraulic equipment, including jacks, slideouts, and steps should be fully retracted before checking fluid level. The oil reservoir is part of the pump/ manifold assembly. The oil level is checked and filled through the breather cap. Clear any dirt away from the breather/filler cap before removing.

The oil level should be within one inch of the top of the reservoir. Most breather caps have a dipstick. Fluid level should be between the bottom of the dipstick and the center mark.

⚠ NOTICE

Overfilling the tank can cause leakage of oil through the breather cap.

NOTE FROM NEWMAR

The hydraulic leveling system was filled with Dexron/Mercon transmission fluid during production. Periodically check the fluid levels in the leveling system when using the breather cap/dipstick. The reservoir level should remain between the oil level grooves when the jacks are retracted. Add fluid as needed. Change the fluid if it becomes contaminated.

⚠ IMPORTANT

Prior to removing the breather cap, either to check the oil level or to use a 1/4" nut driver, clean any debris from the top of the reservoir. Before returning the breather cap to the reservoir, remove any paint chips or other debris from the dipstick, including debris inside the 1/4" nut driver.

Version MP44.000A 13NOV17

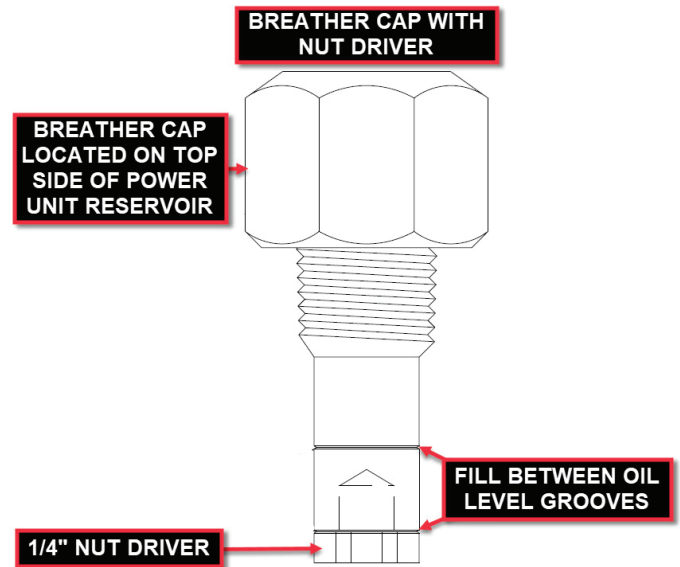

Source(s): HWH Computer-Controlled 725 Series Leveling System Operator's Manual (ML55155, Rev. 09NOV15)

Product(s): This source is associated with more than one product. Refer to Newgle for more information about the product(s) offered for your coach's model year.

Valid Trueline Air Leveling and Electronic Ride Height System with Touchscreen Operation

This article provides brief operation instructions for a Valid Trueline Leveling System with Electronic Ride Height Enhancement Touchscreen (Model: VDC00197).

Overview

The leveling and electronic ride height system uses electronics to control the air suspension for ride control when traveling, and to control the air suspension for leveling when stationary.

The stationary leveling features have both an automatic and manual mode. Auto mode levels the coach with the touch of a button using the air suspension. Manual mode allows each corner to be individually raised and lowered to manually level the coach. Manual mode can be used with confidence, as the system does not allow the coach chassis to be twisted beyond allowable limits.

The ride height of the vehicle can be adjusted when traveling. Normal ride height is automatically selected by default. However, the ride height of the coach can be raised or lowered as needed. For example, high-ride may be selected to negotiate uneven terrain; likewise, low-ride may be selected to give additional clearance to the top of the vehicle.



Operation

The Trueline Leveling System is controlled by a touchscreen. There are three main leveling operating modes –auto level mode, manual level mode, and travel mode. In addition to leveling, the touchscreen may also provide controls for the graphical instrument cluster, tire pressure monitoring system, and more. This depends on how your vehicle is equipped.

The following buttons and indicators are found on the touchscreen.

Tap for function		
	Item	Function
	Power	Turn touchscreen off or exit current mode if ignition on.
	Home Screen	Go to the home screen but stay in current mode.
	Function Button	Perform function as per button label
	Auto Start button, Stop button	Start auto leveling cycle, stop auto leveling cycle
	Mode button	Tap to return to current mode screen if not already on that screen.

Information only			
	Ignition on		Ignition off
	Solid: Park brake on		
	Flashing: Park brake on with transmission in gear		
	Vehicle on slope		
	Twist detected in the chassis		
	Fault indicator		
	Battery power below 10.5VDC		
	Vehicle is in travel mode and not at set ride height.		
	Step switch has made contact with the ground.		

The Truline Leveling System is on when the ignition is on. When the ignition is off, the system can be turned on by pressing and holding the screen for at least 3 seconds until the LED indicator turns green.

TRAVEL MODE

Travel mode is accessed from the home screen. Auto Level and Manual Level are accessed from the leveling screen.

Travel mode is operational when the vehicle is in motion. By default, this mode will initiate when the park brake is released, or when the vehicle begins moving. However, it is best for the operator to enter this mode before the vehicle begins moving by tapping Travel.

The leveling system can only be switched to travel mode if the ignition is turned on. Switching to travel mode causes the suspension to go to ride height.

Because the Truline Leveling System collects information on the ground speed of the vehicle, the operational mode may change automatically depending on the state of the vehicle. For instance, in Manual Air mode, the coach can be driven up to a speed of 5 mph, but if the speed reaches 6 mph the operational mode will change to Travel mode.

AUTO LEVEL MODE

Auto mode can be used to automatically level the vehicle when the vehicle is stationary. This mode is the easiest leveling method to use and is suitable for most leveling situations.

MANUAL LEVEL MODE

Manual mode allows the operator to raise or lower each corner of the vehicle individually using the air suspension. Up to 2 corners can be operated at the same time.

- Manual air mode can be used when the ignition is on or off, and when the vehicle is traveling at low speeds (up to 5 mph).

LEVEL INDICATOR

In manual mode and auto mode, the three level indicator displays can be viewed as a builder's level. The bubbles move to the center once that axis is level.

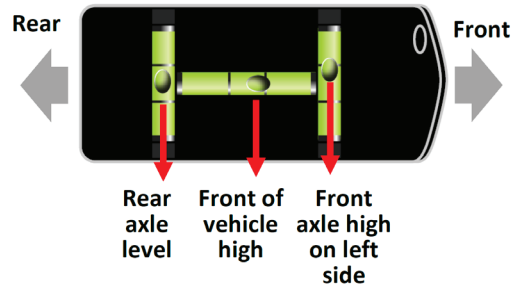

SYSTEM STATUS LED

In addition to the indicators on the touchscreen, there is an LED on the surrounding bezel. The LED flashes or remains steadily lit in green or red to provide information on the leveling system status.

Auto Level Mode

Auto level mode automatically levels the vehicle using the air suspension. The auto mode screen can be reached by tapping Leveling.

When the Auto button is tapped on the auto mode screen, the leveling system detects the lowest corner of the vehicle, and then levels (lowers) the remaining corners to it. If the system determines that it is unable to lower the vehicle to level, any corners that are low will then be raised to the level of the highest corner.

USING AUTO LEVEL MODE

Ensure that:

- The ignition is on and the air system is at full pressure.
 - The parking brake is engaged.
 - The front wheels are straightened.
- Navigate to the Auto leveling screen.
 - Even though you are in the Auto mode screen, the status at the bottom shows 'Manual' until you actually tap the Auto button to begin the leveling process.
 - Tap Auto to initiate a leveling cycle. The LED will flash during auto leveling and turn solid when auto leveling is finished.
 - At any time during the leveling process, it is possible to stop by tapping the Stop button, or go into Manual leveling mode by tapping the Manual button.

- Note: The sensitive leveling sensors require that vehicle movement is kept to a minimum during the leveling process. Therefore, if you are inside the vehicle while it is leveling, please sit still or walk lightly.

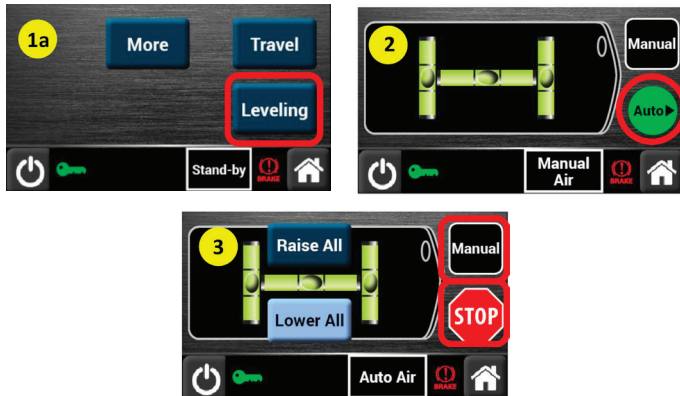

Press AUTO to initiate a leveling cycle. If the level controller will not go into Auto mode it is most likely because the vehicle's parking brake has not been applied, the vehicle is not in gear, or the ignition is off. Ensure the ignition is on, apply the parking brake, and put the transmission into neutral or park to allow the system to enter Auto mode.

AUTO LEVELING CYCLE

The Trueline Leveling System begins by finding the lowest corner of the vehicle. It then lowers the other three corners until the vehicle is level. As the vehicle lowers, it monitors the suspension height. If it reaches the minimum height, it will stop lowering the high corners and begin raising the low corners until the vehicle is level.

Once the auto leveling process completes, the vehicle should be level and the system should go into low power mode.

ONCE THE VEHICLE HAS BEEN LEVELED

The leveling system stores the electronic ride height of the vehicle, measured using the ride height sensors.

After 20 seconds, the touchscreen enters "low power" mode indicated by the Auto Air LP status on the screen. Once the ignition is turned off, the touchscreen will turn off and the leveling system will go to sleep.

After a period of time* (2 hours default) in low power mode, the leveling touchscreen automatically wakes up the leveling system and checks to see if re-leveling is required.

- If no leveling is required, the system goes back to sleep and the touchscreen goes back into low power mode.
- If leveling is required, the Trueline Leveling System returns the vehicle to the previously stored leveled height.

AUTO MODE - NOTES

Once leveling has been completed, additional leveling cycles can be performed if the touchscreen is in auto mode or auto low power mode.

If the ignition is off, touch the screen to turn on the display. To perform another auto level cycle, do one of the following:

- Tap Stop and then Auto, OR
- Tap the Auto Mode status button (at the bottom of the screen)

If the park brake is released while in auto mode, the Trueline Leveling System will switch to manual mode and then to travel mode, if the vehicle accelerates to a speed above 5 mph.

CHANGING THE HEIGHT OF A LEVELED VEHICLE

A leveled vehicle can be raised or lowered to adjust the entry doorstep height.

- To ensure an adequate amount of air, the ignition should be on and the air system should be at full pressure.
- In auto mode, press and hold Lower All or Raise All. This causes the vehicle to move up or down while staying level.

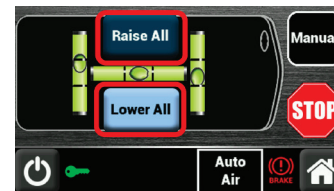

IF THE VEHICLE CANNOT BE LEVELED

If the leveling system is unable to level the vehicle, the SLOPE status will be displayed and the system will go into low power mode. If this happens, the system has determined that it would need to exceed the factory set height limits to level the vehicle.

The Auto button can be tapped to try leveling again, but if the SLOPE status is displayed again, it is not possible to fully level the vehicle on this surface and the vehicle should be moved to a more level surface.

Manual Level Mode

Use manual leveling mode to manually adjust each corner of the vehicle. Manual mode can be used when the ignition is on or off, and when the vehicle is traveling at low speeds (up to 5 mph).

USING MANUAL LEVEL MODE

- Ensure that the vehicle is either parked (but still running) or traveling slower than the manual mode speed limit (5 mph).
- If the vehicle is parked, make sure the front wheels are straight.

1. Navigate to the Manual leveling screen. (Leveling > Manual)
2. Press and hold Raise for any corner you wish to manually adjust. You may press up to two buttons at a time. To control all four corners simultaneously, use Raise All. This can be useful to raise the entry step height.

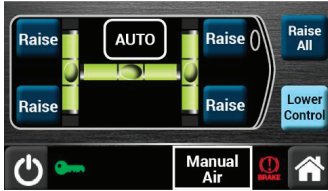

- To lower any or all corners, tap Lower Control. This takes you to the lower/lower all screen. You may toggle between these two screens by tapping the Raise/Lower Control button.

RAISE ALL

When in manual mode, the entire vehicle may be raised while either parked or moving slowly. To allow greater freedom, Raise All has a 'lock' feature that keeps the button activated after being held for 3 seconds.

LOCKING THE RAISE ALL BUTTON

In manual mode, hold Raise All for 3 seconds. This 'locks' the button on for a period of one minute.

- During this time, the vehicle raises continuously and the control panel sounds a repeated beeping tone.
- After one minute is over, the vehicle stops raising.
- The process may be repeated until the vehicle is at the desired height.
- To stop the raising process during the one-minute period, tap either Power or one of the Raise/Lower buttons.

Note: For safety reasons, the Lower All button does not have this lock feature.

MANUAL MODE - NOTES

In manual air mode, if the vehicle begins to move, the Trueline Leveling System automatically switches from manual mode to travel mode at speeds higher than 5 mph.

If the Trueline Leveling System detects an excess amount of twist in the vehicle frame during the manual adjustments, the TWIST status will be displayed. Any further actions that may cause more twist are not permitted by the touchscreen.

Also, if the system detects that the height of a corner is exceeding the factory set height limit (low or high), then the corner will not raise if too high, or lower if too low.

For example: If the vehicle is in a state as indicated at right, the touchscreen will not allow the right front to be raised, the left front to be lowered, the left rear to be raised, or the right rear to be lowered.

Travel Mode (Ride Height)

Travel mode is the operational mode used when the vehicle is in motion.

This mode controls the vehicle's air suspension system. There are three factory-defined levels:

- High Ride
- Normal Ride
- Low Ride

The leveling system can only be switched to travel mode if the ignition is turned on. Switching to travel mode causes the suspension to go to ride height.



USING TRAVEL MODE

1. Turn on the ignition.
2. Tap Travel. The default setting is normal ride height.
 - Low Ride allows additional clearance to the top of the vehicle.
 - High Ride assists in negotiating uneven terrain.

A warning message and flashing LED indicate the system is going to the selected ride height. Once at the desired height the LED turns solid and the NOT AT HEIGHT warning disappears.

To return to normal ride height while in travel mode, tap the Travel LR/HR status.

These modes may be used only under predefined speeds. At higher speeds, the vehicle will go to the normal ride height state, and High Ride and Low Ride buttons will not be enabled. The maximum speeds at which low and high ride can be maintained are set by the manufacturer.

If the Trueline Leveling System is turned off or in any mode other than travel, it will automatically turn on and switch to travel mode if the park brake is released or the vehicle speed exceeds 5 mph.

In travel mode, the LED flashes until normal ride height is reached. If the park brake is released before ride height is reached, the touchscreen will sound a tone every second until the normal height is achieved, or until the park brake is set.

⚠ WARNING

The time required to achieve ride height varies with vehicle design. It is the operator's responsibility to ensure that the vehicle is at an adequate height before driving. If the vehicle is too low, severe damage can result to the fenders when the wheels are turned.

TRAVEL MODE - NOTES

- When travel mode is entered from auto or manual mode, the LED will flash until ride height is achieved. The LED will also flash if high ride, low ride or normal ride mode are set, and will continue to flash until the desired ride height is achieved. It is strongly advised not to move the vehicle while the LED is flashing. It is also unadvisable to negotiate uneven terrain while in low ride.
- Unlike mechanical ride height systems, the automatic ride height system is intelligent, and therefore will not attempt to make ride height corrections while the vehicle is cornering or braking.

LOW RIDE HEIGHT WARNING

- A tone (one long beep per second) will sound if:
- The vehicle's ride height is below a predefined limit, and
- The system is in manual or travel mode, and
- The park brake is off.

This indicates that the suspension is below a safe height and fender damage could occur when turning the wheels.

Other Touchscreen Commands

On the home screen, tap More to access settings for customizing the look of your display, as well as system information, faults, and contact information (Help button).



- **Touch:** The Touch screen (More > Touch) allows you to select the touch sensitivity for the buttons and other touchable areas of the screen.
- **Color:** The color screen (More > Color) allows you to choose background patterns and button colors.
- **Backlight:** The backlight screen (More > Backlight) allows you to adjust the screen brightness.
- **Help:** The help screen (More > Help) displays contact information for Valid Manufacturing Ltd.
- **Faults:** The Faults screen (Home > More > Faults) provides information on any faults that are present in the leveling system. The faults are listed, along with information about the location and cause of each.
- **System:** The System screen (More > System) provides a number of commands.
 - Setup
 - Info
 - Reset
 - Status

Source(s): Trueline Leveling System with Electronic Ride Enhancement Touchscreen Operation Guide (VDC00197, Rev B 7-Feb-19 MW)

Product(s): This source is associated with more than one product. Refer to Newgle for more information about the product(s) offered for your coach's model year.

**Steering Systems****Comfort Drive™ Steering (Steering Effort) Overview**

This article provides information about Comfort Drive™, an intelligent steering system that adapts to your inputs while actively working to eliminate friction, creating a self-straightening steering wheel that lets you navigate twists and turns with more confidence and less effort.

Features like Newmar's Comfort Drive™ Steering allow easy maneuverability with just a light grip on the wheel, taking the chore out of driving long distances.

Operation

To use the Comfort Drive feature, simply steer the coach like you would any other vehicle, and adjust the settings to suit your preference for steering effort. A lower setting makes the coach easier to steer, whereas a higher setting requires more effort.



Comfort Drive™
STEERING

Dash Adjustment Knob

On coaches with an adjustment knob located on the dash, turn the knob to the desired setting.



Spartan Steering Wheel via 2-Switch Pod Controls and Valid Glass Dash Display

On select Spartan coaches, the Comfort Drive setting can be changed using the controls on the right side of the steering wheel. The settings can be viewed and adjusted on the Spartan Valid Glass Dash.



From the menu on the glass dash:

1. Navigate to “Comfort Drive” on the screen using the up and down arrows.
2. Press the “OK” button on the steering wheel to select.
3. Once on the “Comfort Drive” screen, use the up and down arrows to navigate to the desired comfort drive setting (1-5).
4. Press the “OK” button on the steering wheel to confirm the desired setting.

Spartan Steering Wheel via 3-Switch Pod Controls

Starting with the 2023 model year, select Spartan coaches (Ventana, Dutch Star, New Aire, Mountain Aire, London Aire, Essex, and King Aire) are equipped with a 3-switch pod steering wheel. The Comfort Drive setting can be changed using an alternative adjustment toggle switch located behind the right-hand steering wheel pod. This switch allows the driver to adjust the steering effort without scrolling through the Valid Glass Dash Display menus.



Freightliner Steering Wheel Controls via OmniView Instrument Panel

On select Freightliner coaches, the Comfort Drive setting can be changed using the controls on the left side of the steering wheel. The settings can be viewed and adjusted on the Freightliner OmniView Instrument Panel.

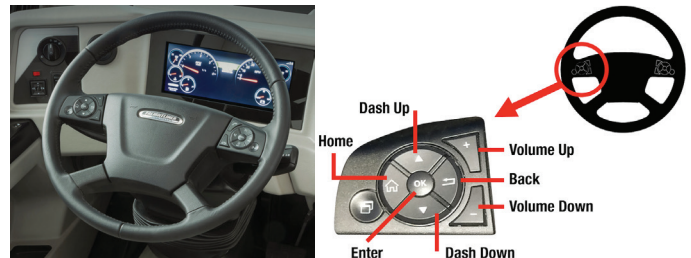

From the menu on the instrument panel:

1. Navigate to “Vehicle Configuration” on the screen using the up and down arrows.
2. Press the “OK” button on the steering wheel to select.
3. Navigate to “Steering Effort” on the screen using the up and down arrows.
4. Press the “OK” button on the steering wheel to select.
5. Use the up (MORE) and down (LESS) arrows to navigate to the desired steering effort setting.
6. Press “OK” to select the desired setting. This setting will be memorized in the system and will only need to be changed if the system is reverted to the default setting or if a second driver prefers a higher or lower setting.

Starting with the 2023 model year, select Freightliner coaches (Kountry Star, Ventana, Dutch Star, New Aire) have the steering effort factory-set on the Favorites menu on the Valid Glass Dash menu. The setting can be adjusted using the up and down arrows without scrolling through the Glass Dash menus.

NOTE FROM NEWMAR

Starting with the 2023 model year, the Favorites button will be preset from the factory to quickly access Steering Effort (also known as Comfort Drive). If the Steering Effort does not come up, the Favorites button may have been inadvertently reset. The Favorites button can be reset at any time by pressing and holding it down for five seconds while on the desired setting.

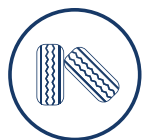

Wheels and Tires

Wheels and Tires Size and D.O.T. Code

This article provides basic information about the wheels and tires, including the tire size, inflation, and D.O.T. codes.

Newmar's quality extends to every inch of your coach, right down to the tires and wheels. The durability and longevity of your tires will provide you with the confidence and peace of mind you need to relax and enjoy the ride.

The primary areas of concern are the tire size, inflation, and operational information. The sidewall of the tire contains detailed information about the construction, inflation, and carrying capacity of the tire. Become familiar with this information, and operate the vehicle within the capacity parameters outlined.

WARNING

Proper tire maintenance is critical to the safety, operation, and durability of your coach. Failure to follow and monitor tire pressure guidelines may result in premature tire failure.

Tire Size

The sidewall of the tire contains information that is important to know to ensure proper use of the tire, as well as to maintain long life. Take the time to become familiar with the size, load rating, and pressure information listed on the sidewalls of the tires.



This tire size is 315 / 80 R 22.5. From this size, we can determine the physical dimensions of the tire, as well as its basic construction. The tire size breaks down like this:

- The first number, "315", is the section width of the tire in millimeters. The section width is the measurement of the tire from the outside sidewall to the inside sidewall.
- The second number is the height of the sidewall, expressed as a percentage of the section width. In this case, the number is "80", so the sidewall height accounts for 80 percent of the tire's section width.
- The "R" in the tire size indicates that this tire is "radial" in construction. The belts are wrapped around the tire in a radial design, from bead to bead.
- The final number is "22.5", which is the rim size the tire was designed to fit. This tire fits a 22.5" diameter wheel.

D.O.T. Code

The last four digits on tires manufactured after the year 2000 signify the week and year of manufacture.



The tire in the example picture was made during the 29th week of 2017.

Tire Care and Maintenance

This article provides information about the care and maintenance of your coach tires, including examples of labels and tire pressure charts. To ensure your tires are operating safely, regularly inspecting your tires and checking your tire pressure is absolutely mandatory.

NOTICE

For specific recommendations related to tire pressure, rotation, or replacement, please contact the tire and/or chassis manufacturer.

NOTICE! **CHECK WHEEL LUGS**

On first trip, tighten wheel lugs at start and at 10, 25 and 50 miles. Tighten to manufacturer's specifications.

Thereafter, check wheel lugs before each trip, after excessive braking and following winter storage.

AD-24

Tire Pressure Overview

Tire pressures should be checked and adjusted before and after each trip. Always check and adjust the pressures while the tires are cold. Never add or release pressure from the tires when they are hot (after having driven a mile or more).

For safe operation and maximum weight carrying capacity, it is imperative that the tires be inflated to and maintained at the listed tire pressures on the Federal ID Tag. This tag is affixed to the interior wall just behind the driver’s seat in your coach.

Make sure tire pressures are the same across an axle, while NEVER exceeding the maximum air pressure limit stamped on the wheels or tires nor under inflating a tire below the lowest pressure on the tires inflation chart. For more detailed information refer to the tire inflation pressure article in Newgle.

295/60R22.5 J												
PSI	85	90	95	100	105	110	115	120	125	130	Maximum load & pressure on sidewall	
kPa	590	620	660	690	720	760	790	830	860	900		
LBS	Single	5260	5505	5750	5990	6230	6465	6700	6930	7160	7390	S 7390 LBS at 130 PSI
	Dual	9650	10100	10550	10990	11430	11860	12290	12720	13140	13560	D 6780 LBS at 130 PSI
KG	Single	2385	2495	2610	2715	2825	2930	3040	3145	3230	3350	S 3350 KG at 900 kPa
	Dual	4375	4580	4785	4985	5185	5380	5575	5770	5960	6150	D 3075 KG at 900 kPa

Example of a Tire Inflation Chart

Use the inflation chart provided by your specific tire manufacturer according to brand, series, size, and load range. Also, pay attention to the chart when referring to dual or single tire configurations, as they will change based upon which tire you are inflating.

⚠ WARNING

Failure to follow proper inflation guidelines may result in tire failure, which can cause loss of vehicle control or accidents resulting in property damage, bodily injury, or death.

⚠ IMPORTANT

The tire pressure settings can change depending on whether they are used in single or dual tire situations.

⚠ IMPORTANT

Make sure the tire pressures are the same across an axle, while never exceeding the maximum air pressure limit stamped on the wheels or tires, or leaving a tire below the minimum pressure listed on your tire inflation chart.

⚠ IMPORTANT

Do not use the example to find your recommended tire pressures. Refer to your tire manufacturer’s owner’s manual and specific tire inflation guidelines.

⚠ NOTICE

Exact tire inflation charts will not be provided by Newmar. Each tire manufacturer provides this information, as it changes by brand, make, tire series, tire size, as well as if it is used in a single or dual setup. For more information about your tires and the inflation specifications, please refer to the Item Home Page of your tire manufacturer.

If you are operating your coach while staying significantly under the maximum weight carrying capacity, you may experience an unnecessarily firm ride. To correct this condition, it is recommended for you to weigh the coach when it is fully loaded as you would travel, with full fuel, water, and LP tanks, all travelers, and your belongings, as well as any towed equipment. Weigh each axle end separately, and use the heaviest end weight to determine the axle’s cold inflation tire pressure.

For units operating significantly under maximum weight carrying capacity experiencing an unnecessarily firm ride. We recommend for you to weigh the coach loaded as you will be traveling with fuel, water, Lp, belongings, persons and weight of towed equipment, weighing each axle end separately and using the heaviest end weight to determine the axle’s cold inflation tire pressure use the inflation chart provided by the tire manufacture for you specific brand, series,& size and load range of tire use the dual and single weight charts according to the tire configuration you are inflating.

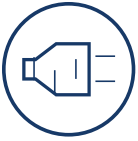

ELECTRICAL

This chapter includes overviews of the 12 volt and 120 volt electrical systems, as well as information about electrical equipment that may be installed in your coach, including, but not limited to fuse panels, lighting, EMS, generators, inverters, converters, solar panels, transfer switches, etc.

⚠ WARNING

Due to the risk of electrical shock, service should be performed by a qualified electrician or authorized service technician. The electrical system may have multiple 120/240 volt power sources. All power sources must be turned off, and any auto generator start features must be disabled prior to servicing.

⚠ IMPORTANT

Any of the following quick start instructions provided by Newmar should not take the place of the manufacturer's complete documentation. Refer to Newgle for more information about electrical components offered for your coach's model year.



12 Volt Electrical System

This article provides general information about the components and functions of the 12 Volt Electrical System (DC) in Newmar coaches.

Power Sources

The 12 Volt Electrical System allows certain components to maintain a low voltage from the battery bank. The battery bank is controlled by the coach charging system, which consists of a charge bridge solenoid, a bi-directional isolator relay delay (BIRD), or a battery isolation manager (BIM). When the coach engine is running, the alternator charges the chassis batteries and may assist in charging the house batteries through the BIM, BIRD, or Charge Bridge.

When the coach is connected to shore power or when the coach generator is in use (when shore power is unavailable), the converter or inverter/converter combination recharges the house batteries, and with the assistance of a BIM, BIRD, or Charge Bridge, it can also charge the chassis batteries.

In addition to the alternator and converter, the coach may also be equipped with solar panels to provide an additional option for charging your house batteries.

THIS CONNECTION IS FOR
LOW-VOLTAGE BATTERY OR
DIRECT CURRENT ONLY. DO
NOT CONNECT TO 120 OR
240 VOLTS AC. AD-06

ALTERNATOR

The alternator is a belt-driven component attached to the coach engine and is supplied by the chassis manufacturer. The alternator supplies power for chassis components such as batteries, lights, wipers, dash HVAC, and power seats, as well as all of the driver controls located in the cockpit. The alternator charges the chassis batteries, but with the addition of a BIM, BIRD, or Charge Bridge, it may also assist in charging the coach's house batteries.

GENERATOR

When shore power is unavailable, the generator takes mechanical energy and converts it into alternating current to supply 120 volts to the coach and charge the coach's house via the converter or inverter/converter and the chassis batteries via BIRD, BIM, or charge bridge.

The generator is typically located in the front of the unit between the frame rails on diesel coaches. On gas units, the generator may be located anywhere between the mid and rear section of the coach. Generators can be powered by gas, liquid propane, or diesel fuel.

CONVERTER AND INVERTER/ CONVERTER COMBINATION

All Newmar coaches are equipped with a converter or inverter/converter combination. A converter transforms alternating current or shore line power 120 Volts to low-voltage direct current to provide power to the coach's 12 Volt house and chassis batteries. On the other hand, an inverter transforms direct current to alternating current to provide power to specified appliances and entertainment systems.

SOLAR PANEL

Some Newmar units are equipped with a 10 Watt solar panel wired to the chassis batteries. Prior models may have a five or 10 Watt solar panel and may be wired to the chassis-side KIB panel.

BATTERIES

Please refer to the Battery Basics article for more information.

Power Distribution

BATTERY DISCONNECT

Newmar uses an Intellitec disconnect relay connected to the battery bank to disconnect certain loads when placing the coach in storage. Keep in mind that not all loads are disconnected. This is very important to remember when a coach is put into storage and is not plugged into shore power. Before placing the battery disconnect in the “off” position, make sure the inverter (if equipped) is turned off.



When an older coach is stored while plugged into shore power, do not use the battery disconnect. If the battery disconnect is used, the chassis batteries will not receive a charge from the converter or inverter/converter combination. This is due to the coach battery wire being disconnected, meaning the BIM or the BIRD will not engage.

Some coach models have a manual rotary key switch to disconnect power, which is located in the overhead above the entry door. Most other coaches have a single lighted switch located in the front overhead that turns off the house voltage.

⚠ IMPORTANT

When the battery disconnect is ‘off’, meaning you have disconnected components from the batteries, there are still some loads on the batteries connected to the hot side of the Battery Disconnect Relay. Some of these loads may be Radio Memory, Entry Steps, and LP Detector. These will draw from the batteries, even when the disconnect is ‘off’. Pull the fuse for each of the ‘HOT’ circuits to stop the batteries from being drained.

To learn more, visit the Battery Disconnect home page in Newgle.

BI-DIRECTIONAL ISOLATOR RELAY DELAY (BIRD)

Current gas coaches and some older diesel coaches, use an Intellitec Bi-Directional Isolator Relay Delay (BIRD) with a separate solenoid. The BIRD monitors both the chassis and house battery and is the only place in the coach where they both merge. The BIRD only functions when the engine or generator is running or when the coach is connected to shore power.



To learn more, visit the Bi-Directional Isolator Relay Delay home page in Newgle.

BATTERY ISOLATION MANAGER (BIM)

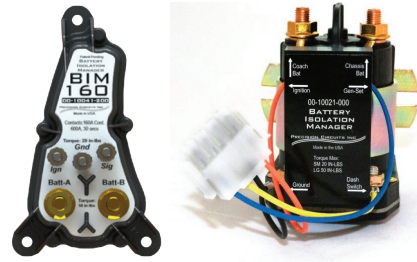

All current Kountry Star, Super Star, Dutch Star, and Ventana diesel coaches use a Precision Circuits all-in-one Battery Isolation Manager (BIM). The BIM monitors both the chassis and house battery and is the only place in the coach where they both merge. The BIM only functions when the engine or generator is running or when the coach is connected to shore power.

To learn more, visit the Battery Isolation Manager home page in Newgle.

CHARGE BRIDGE SOLENOID

All current model New Aire, Supreme Aire, Mountain Aire, London Aire, Essex, and King Aire coaches use Silverleaf, a computerized coach management system.

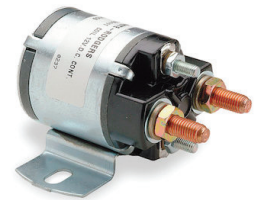

One of its many functions is to control the battery charging through the Charge Bridge Solenoid. The TM102 module monitors the battery state and senses the house and chassis battery voltage. When the parameters are met, the TM102 module activates the solenoid, causing it to bridge or connect the chassis and house battery banks.

For more information on your coach’s TM102 module, refer to the SilverLeaf Functional Guide in Newgle.

FUSE BLOCKS AND MINI-BREAKERS

When a 12 Volt wire is ran, most of the circuits are protected with fuses or mini-breakers. These can be located at various areas in the coach but are typically located near the main breaker panel. The following photos are examples only. However, they may also be found in areas such as:

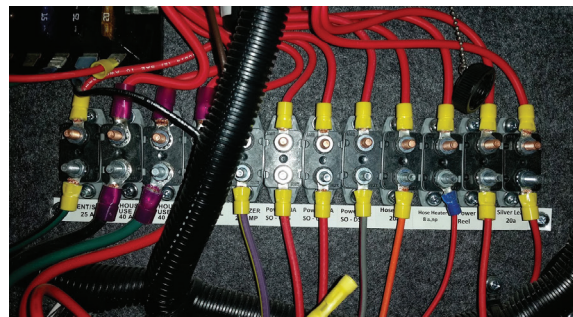

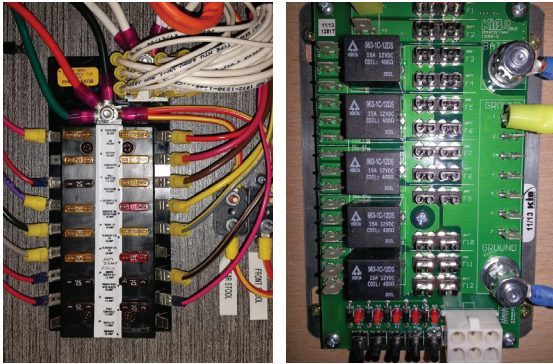
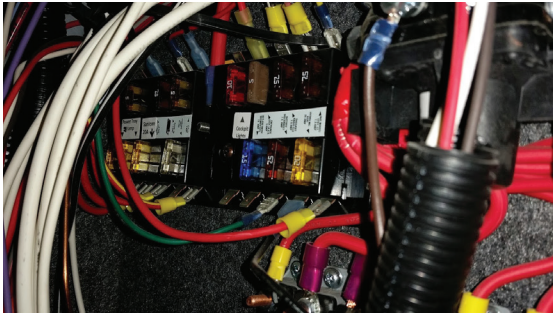

Basic 12 Volt Power Flow

Since a battery is only an electrical storage component, 120 Volt power must be present to charge the batteries from the converter or inverter/converter combination unit. It is necessary to have 12 Volt power supplied from the coach's house battery bank in order to operate the interior lights and other 12 Volt loads such as slideout control systems, water pumps, vent fans, monitoring systems, etc.

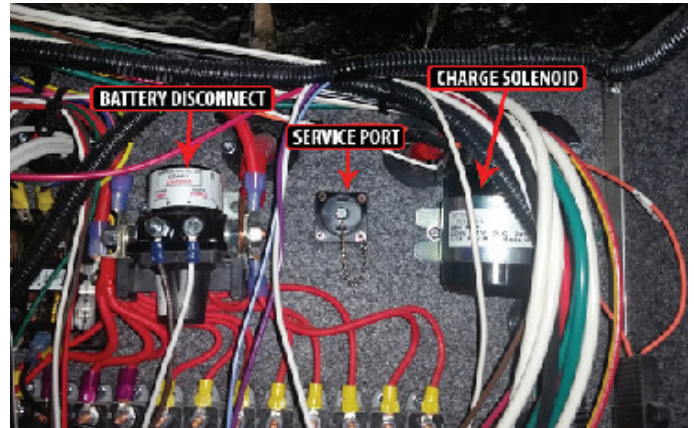

Most of this power flows through the battery disconnect to the fuse block or mini-breakers, which prevents overloading the circuit prior to progressing to the 12 Volt load. There are some 12 Volt circuits that do not go through the house battery disconnect; however, these loads still pass through a fuse or mini-breaker before progressing to the load.

INTERIOR

- Rear bedroom
- Rear bathroom
- Closet
- Front Overhead Cabinet

EXTERIOR

- Power cord compartment
- Left, front electrical compartment (located beneath the driver window)
- Front firewall (gas coaches)

There are also some circuits that are protected with an inline fuse. Some fuse blocks have fixed relays integrated on a board. The board below is located in the cord compartment.

IMPORTANT

When a 12 Volt load or component is not working, both 12 Volt power (+) and 12 Volt ground (-) are needed for the load to complete the 12 Volt circuit.



120 Volt Electrical System

This article provides general information about the components and functions of the 120 Volt Electrical System (AC) in Newmar coaches.

Power Sources

There are three types of alternating current (AC) power sources available to the coach: shore power, generator power, and inverter power. Shore power is provided by the RV park or by home service outlets and should be used whenever possible. Generator power should mainly be used when shore power is not available, specifically while traveling, when 120 Volt power is necessary to run high amperage loads, or when dry camping requires 120 Volt for battery charging. Inverted power is mainly used for light 120 Volt loads when shore power is not available and generator power is not desired.

GENERATOR POWER

Generator power is produced within the generator and is output through the main wiring to the transfer switch. From the transfer switch, the power moves to the main breaker box where it is dispersed to individual circuits (outlets) and hard-wired components such as a water heater or boiler. From the inverted circuits, generator power will then travel through the inverter's internal transfer switch and back to the inverted subpanel to be dispersed through the individual breakers to the outlets or appliances.



INVERTER POWER

This type of power starts at the battery bank. The battery bank supplies 12 Volt power through cables to the inverter, which uses the 12 Volt direct current to produce 120 Volt alternating current. The inverter performs this action by using a transformer to increase the voltage and modify the higher voltage into a useable alternating current power. Power then goes to the inverted sub panel, which is dispersed through the individual breakers to the outlets or appliances.

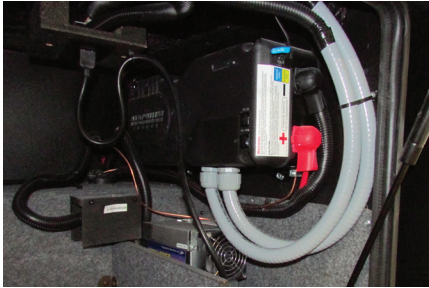

The inverter may provide battery charging while 120 Volts is supplied via the generator or shore power. The inverter performs this action by using the transformer to decrease the voltage and rectify the alternating current into useable direct current voltage. This is regulated by internal sensing circuitry based upon the battery bank's state of charge and several other factors, depending on the coach's particular inverter brand and type.

SHORE POWER

Most RV parks provide 30 Amp, 120 Volt at the site; however, many parks also provide 50 Amp, 240 Volt service to accommodate the electrical needs of newer and larger coaches. Shore power is supplied to the coach via a power cord. Two sizes of power cords are found in Newmar coaches: 50 Amp and 30 Amp. The 50 Amp cords are made up of four conductors #8 stranded wire and a molded plug. The 30 Amp cords are made up of three conductors #10 stranded wire and a molded plug.



Shore power enters through the 30 or 50 Amp power cord to the power cord reel (if equipped). From the power cord reel, it travels to the transfer switch and then to the main breaker box where it is dispersed to the individual circuits to supply power to hard-wired components such as air conditioners, water heaters, etc. and then to the inverter (if equipped).

The inverted circuits move from the inverter's internal transfer switch to the inverter subpanel (a smaller breaker box). From the subpanel, the power circulates to the individual breakers and to the electrical outlets and appliances.

SHORE POWER ADAPTERS

⚠ IMPORTANT

Newmar Corporation does not recommend use of adapter, cheater, or dog-bone style connectors that will modify the existing shore power cord to a different style of outlet. Use of this type of adapter will greatly reduce the amount of available current in the unit, as well as create the potential for electrical failure and/or fire.

If an adapter is used, there are three common sizes of power cord adapters available to adjust to a smaller amperage outlet:

1. 30 amp to 20 amp
2. 50 amp to 20 amp
3. 50 amp to 30 amp



It is important to understand the risks involved and the possible effects of using adapters in conjunction with your coach. Some of these risks and possible effects include:

- Melted or damaged adapters causing poor connection (or no connection at all)
- Melted or damaged 30 or 50 Amp plugs causing fluctuations in voltage that may damage electronics
- Insufficient amperage causing the tripping of a breaker at the post or a limited use of appliances

Low voltage can also be caused by use of adapters, long extension cords, or extension cords with an insufficient wire size.

⚠ IMPORTANT

Newmar Corporation cannot assume liability for failures occurring to the RV, its electrical system, or any of its components from the use of any electrical adapter.

AUTOMATIC TRANSFER SWITCH

Current coaches with a generator will also have a transfer switch installed in the cord compartment. An automatic transfer switch converts two inputs and connects them to a single common output.



The shore power cord is connected to one of the inputs, while the generator is connected to the transfer switch's second input.

Automatic transfer switches are logic-controlled to convert under a given set of conditions. The transfer switches used in RVs are typically generator priority switches which connect to shore power under normal use. As soon as the transfer switch detects the presence of 120 Volt power on the generator input lines, it will switch over to the generator's inputs and drop the connection to shore power.

Transfer switches are designed so that only one input can be connected at a time in order to prevent any back feeding of electrical power. In addition, RV transfer switches generally have a built-in delay allowing the generator to warm up and speed up before actually switching the load. This prevents stalling or stumbling while the engine is still cold and not producing full power.

MAIN SERVICE PANEL BREAKER BOX

The main service panel or 120 Volt breaker box is typically located inside a bathroom, bedroom, or front overhead cabinet depending on the coach model and floor plan. The breaker box contains the main 50 Amp (or 30 Amp if equipped) breaker and the individual breakers protecting each circuit from overload conditions. Any unit equipped with two air conditioners or more must have 50 Amp service. The task of the breaker is to "trip" if the current exceeds the amperage rating on the breaker to prevent damage to the wiring of the circuit.

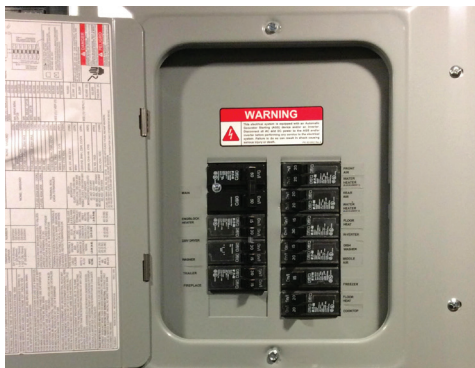

The breakers are resettable by simply flipping the breaker to the 'off' position, and then back to the 'on' position once the overload condition is removed. All 120 Volt circuit breakers are located in the main service panel unless the coach is equipped with an inverter/charger. These units are also equipped with a subpanel.

IMPORTANT

Breakers positioned next to each other are on different poles in a 50 Amp panel. If only part of the electrical circuits are working, you may have a poor connection at shore power. In this instance, power is most likely only being provided to one pole or leg.

SUBPANEL

The subpanel is a smaller 120 Volt breaker box containing the breakers for the circuits which the inverter is wired to power. It is typically located near the main breaker box unless the coach is equipped with an Energy Management System (EMS). In this case, the subpanel is often located within the EMS panel. The subpanel is installed to limit the AC power use to specific circuits when the electricity is supplied by the inverter. Some inverters may be used to power a specific circuit. In this case, a subpanel is not used.



AUTOMATIC GENERATOR START (AGS)

On coaches equipped with AGS, the generator will start and provide 120 Volt power if the incoming shore power voltage is not present and startup parameters are met.

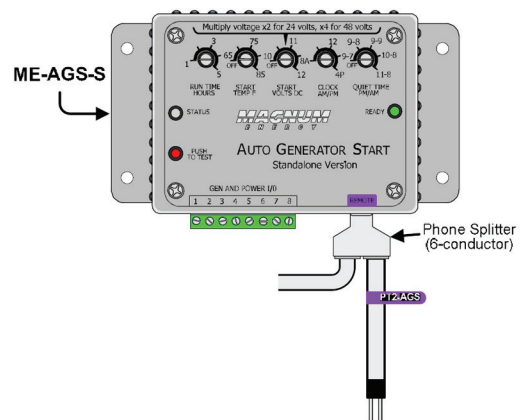

▲ IMPORTANT

This function must be enabled in order for the AGS to function properly.

The AGS may be controlled via the ME-AGS or SilverLeaf. ME-PT2 can be used in conjunction with the Dometic Duo-Therm kit and Comfort Control Center (CCC II Thermostat) or KIB L-Panel to connect the t-stat output of the A/C directly to the AGS. This allows the AGS to start on demand from the A/C for either heat (heat pump only) or cool.

1. Follow Comfort Control Center or KIB L-Panel instructions for proper zones, heat, cool and AGS settings.
2. The ME-AGS-S will now start on demand from the Comfort Control Center or KIB L-Panel.

For more information about AGS operation via the SilverLeaf system, refer the year/model-specific SilverLeaf Touchscreen Guide in Newgle.

50 AMP ENERGY MANAGEMENT SYSTEM (EMS)

The 50 Amp Precision Circuits Energy Management System is currently offered as standard or optional equipment on all coaches not equipped with a SilverLeaf Coach Management System. Its function is to provide power management for certain 120 Volt loads and as a system of energy management to minimize the overloading and tripping of circuit breakers. The EMS contains a main distribution panel with a self-contained control module and a remote display panel, which is typically located in the dash overhead electrical control cabinet.

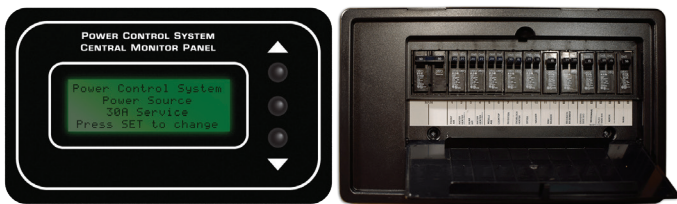

The EMS control module automatically senses the available power being supplied to the coach. The module determines whether it is connected to a 50 Amp (240 Volt) or the generator. On 120 Volt service, it is unable to determine if the source is providing 30, 20 or 15 Amp shore power. Depending on available power, it can control up to seven loads.

The EMS controls air conditioner loads using low-voltage switching and other 120 Volt, heavy-load appliances, such as block heaters, water heating elements, and air conditioners. The EMS will also control the 2012 Magnum inverter charge rate or switch to invert depending on the charging status. The charger will only reduce once it is in float status.

The current-sensing relay will display the amperage on each leg. The EMS will start shedding loads and look at the AC current when it sheds a load, determining when it has enough current available to turn on the load again.

When the EMS sheds a load, it only looks at one leg to see how much of a load was shed. For coaches equipped with the SilverLeaf system, refer to the SilverLeaf Functional Guide for more information on your EMS.

CONVERTERS

All Newmar coaches are equipped with a converter or an inverter/converter combination. Converters are used to transform alternating current power (120 Volt AC) to direct current power (12 Volt DC). Converters supply the coach with 12 Volt power to operate systems in the coach and provide battery charging.



Newmar currently uses three sizes of converters: 45, 60, and 80 Amp models. Previous units may have a 55 or 75 Amp converter or two 45 Amp converters with a total of 90 Amps available. When replacing a converter, it is necessary to use the same size converter to ensure sufficient wiring and breakers for the converter's input and output ratings.

Possible causes of converter failure:

- Overheating caused by cooling fan malfunction or inadequate ventilation causing damage to the converter
- Blown fuses

INVERTERS

An inverter changes 12 Volt DC power to 120 Volt AC power. Coaches with an inverter only typically use it for powering the entertainment equipment like the TV, DVD, and Blu-ray players. The inverters used for this purpose are usually 600 watt to 1000 watt (1000 Watt inverters may also power a small refrigerator) and do not have battery charging capability.



The inverters are usually located in a basement compartment of the coach. Some inverters have a remote panel for an on/off switch in the overhead driver area or above the entry door. When power is supplied by either the generator or shore power, the inverter merely allows the power to “pass through” and will then stop pulling power from the batteries to try and supply 120 Volt power. There is a protective breaker on the inverter to prevent circuit overload.

Possible causes for inverter failure:

- Overheating caused by inadequate ventilation causing damage to the inverter
- Overloading the circuit causing “tripped” breakers

INVERTER/CONVERTER COMBINATIONS

Many Newmar coaches are equipped with inverter/charger combination units, sometimes referred to as an inverter/converter unit. These units range from 1200 to 3000 Watt and serve as a three stage charger and an inverter. Coaches equipped with this option will also be equipped with a 120 Volt subpanel.



The subpanel is used to limit the circuits powered by the inverter(s). This is necessary to avoid draining the batteries by supplying inverted power to all circuits. The subpanel is located next to the main service panel. On units equipped with an EMS, the subpanel is located in the same breaker box but is separated in the interior of main panel. The coach battery bank supplies the inverter 12 Volt power and has a high amp fuse link on the positive lead from the batteries and is located near the battery bank.

The inverter/charger can be controlled by a remote panel, from another system like SilverLeaf, or at the inverter itself. The remote panel is typically located in the front overhead compartment or above the entry door and is used to control the inverter and the battery charging functions. If a remote panel is connected to the inverter, then the remote panel takes priority.

THREE-STAGE CHARGING PROCESS

The charging cycle uses three states: bulk, absorption, and float. During the initial bulk stage, the inverter charges at near its full current ability. This causing the battery voltage to rise over time. After the battery voltage reaches the bulk voltage setting, the charger starts the absorption stage.

During this phase, the charge rate is gradually reduced while the battery voltage is held near the bulk voltage setting. This insures that the battery is fully charged. The float stage is initiated when the battery has been held at the bulk voltage setting for the absorption period. At this point the battery voltage is allowed to fall to the float voltage setting, where it is maintained until another charge cycle is initiated. This reduces gassing of the battery and keeps it fully charged. A new three stage charging cycle is initiated after an AC source is reapplied to the AC input terminals.

GROUND FAULT CIRCUIT INTERRUPT (GFCI) OUTLETS

The Ground Fault Circuit Interrupt (GFCI) outlets protect the user from ground faults between a hot wire and ground. The 120 Volt electrical outlets in the kitchen and bath area are GFCI protected receptacles. The electrical outlets located in the Slideouts are wired through the kitchen GFCI. The exterior electrical outlets are wired through the bathroom GFCI. On units equipped with the floor heat option, a separate GFCI is installed in the bathroom or near the main breaker box. Units with the holding tank heat pad option will have an additional GFCI located in the basement area; however, the exact location varies.



The GFCI outlets should be tested at least once a month. The 120 Volt electrical system must be energized in order to test the GFCI. The reset button needs to be pressed before starting the test. Then push the test button, which will cause the reset button to pop out, confirming the protected circuits have been disconnected. Push the reset button again until a click is heard to reactivate the protected circuit. If the GFCI is working properly, the reset button will remain in the “IN” position. If an item plugged into a Slideout or outside receptacle is not working, check for a tripped GFCI in the kitchen or bathroom. Likewise, if the floor heat or holding tank heat pads are not working, check the GFCI for that circuit.

WARNING

The GFCI will not reduce the shock hazard if the short is between a neutral and hot wire or two hot load wires.

120 VOLT OUTLETS

Several 120 volt receptacles are located throughout the interior of the unit. These receptacles require three-pin plugs that provide proper grounding to protect you from electrical shock. The breaker for the outlets are usually located in the breaker box. If the breakers are on the inverted circuitry, they will be located in the subpanel near the main breaker box.



⚠ IMPORTANT

Do not use an adapter, cheater, or extension cord that breaks the continuity of the ground circuit to the ground pin. Never remove the ground pin from a plug in order to connect it to a two-pronged ungrounded outlet.

Electrical Typical Amp Draw List

This article provides a basic overview of the typical amp draw of electrical components and appliances in a coach.

Knowing and understanding the electrical terminology, as well as the average amperage (current draw) of all the electrical appliances in your coach, can help you manage electrical use and prevent the inconvenience of tripping a breaker.

Amp Draw

Do you know how many Amps you are using at any single moment? It is surprising how quickly the current draw (Amps) of your appliances can add up for your coach's 30 or 50 Amp system. Knowing and understanding the electrical terminology, as well as the average amperage (current draw) of all the electrical appliances in your coach, can help you manage electrical use and prevent the inconvenience of tripping a breaker.

Below is a list of the typical appliances used and the approximate amps required to operate them.

- V = volt; volt is the measurement of electrical pressure
- A = amp; amp is the measurement of electrical current (volume) used by an electrical device.
- W = watt; watt is the measurement of how much electrical work is being done.

Appliance	Required Amps
Air Conditioner (depending on brand, BTU rating and options)	14.0 to 16.0 Amps
Inverter (depending on wattage rating, brand, and model)	9.0 to 18.0 Amps
Converter with continuous 12 volt power supply (depending on amp rating and brand)	11 to 17 Amps
Refrigerator (residential compressor-type)	8.5 to 12.0 Amps
RV Refrigerator (Absorption)	2.7 to 6.4 Amps
Microwave Oven	11.3 to 14.2 Amps
Washer and Dryer (2-piece)	16.0 Amps
Television (depending on size, brand, and type)	1.0 to 3.0 amps
Central Vacuum Cleaner	11.3 Amps
Electric Hot Water Heater (depending on brand and type)	11.7 to 12.5 Amps
Food Processor	6.0 Amps
Ice Maker	4.0 Amps
Electric Freezer (Compressor)	6.4 Amps
Hair Dryer (1500w)	12.5 Amps
Electric Coffee Pot	9.0 Amps
Iron	10.0 Amps
Radio	0.8 Amps
Toaster	8.0 Amps
Electric Frying Pan	10.0 Amps
Coffee Maker	10.0 Amps

Conversions

You can look at at your electrical appliances, find the label that contains amperage or wattage ratings and calculate exact usage by using the formulas below.

- Watts/Volts = Amps
- Amps x Volts = Watts
- Watts/Amps = Volts

EXAMPLE

Most products requiring electricity provide how many amps or watts it typically utilizes. If your electric hot water heater is always in use (~12.5 amps), and you start your air conditioner (~15.0 Amps) and put on a pot of coffee (~9.0 amps) and make some toast (~8.0 amps) while watching TV (~ 2.0 amps), you have far exceeded the 30 amp service, resulting in a tripped breaker.

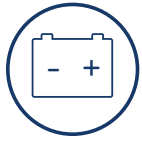

Batteries

Provides information about the house and chassis battery banks, battery inspection and care, as well as battery replacement.

Battery Basics

Introduction

As with anything technical, greater knowledge of the basics may help you increase performance, reliability, and longevity, as well as prevent future problems with your batteries. This article will provide information regarding your coach batteries; however, this is only one aspect of your coach's electrical system. To learn more about your batteries' role within the system, please refer to the 12 Volt Electrical article.

Commercial lead acid batteries have been used for over 150 years. The same chemical principal used to store energy now was also used many generations ago. Present day chassis battery power requirements are tremendous, considering today's vehicles and all of the electrical devices that must be supplied. All of these electronics require a reliable power source, and poor battery condition may lead to expensive electronic component failure. A battery is like a piggy bank - it stores energy, but cannot produce it. If you continue to withdraw without making any deposits, you will soon have nothing left.

Life Span of A Battery

Not long ago, motor homes only used a single 12 Volt house battery. Today, however, it is standard to have at least two batteries, and up to 16 total in some Newmar coaches, powering inverters up to 3000 watts. As energy requirements increase, the average battery life decreases. The life span of a deep cycle battery will vary considerably with how it is used, how it is maintained and charged, temperature, and other factors. The life span is dependent upon usage but often ranges between six months to 48 months. Only 30 percent of all batteries actually reach the 48 month mark.

It is best practice to change the complete battery bank when a new battery becomes necessary, as the battery bank is only as good as the weakest cell. One simple way to extend battery life is to hook it up to a solar charger during the off months.

Many people don't take into consideration how much power may be used by the inverters charging circuits mostly because they are working automatically in the background. 50 amp service has two 50 amp power legs, providing a total service of 100 amps.

Common Battery Terms

Ampere (Amp) - A unit that defines the flow rate of electricity (current) in a circuit.

Amp Hour (AH) - Measurement of electrical storage capacity on a deep cycle battery. The standard amp rating is taken for 20 hours. Example: A 100 AH rated battery is determined like this: Draw from the battery for 20 hours provides a total of 100 amp hours, translating to about five amps an hour (5 amps x 20 hours = 100 AH). However, it is important to know that the total time of discharge and load applied is not a linear relationship. As your load increases, your realized capacity decreases. This means if you discharged that same 100 AH battery by a 100 amp load, it will not give you one hour of runtime. On the contrary, the perceived capacity of the battery will be about 64 AH.

Cold Cranking Amps (CCA) - Measures the number of amps a battery can deliver at 0° F for 30 seconds without dropping below 7.2 Volts (1.2 Volts per cell). A high CCA battery rating is especially important in engine-starting battery applications and in cold weather. This measurement is not particularly important in deep cycle batteries, though it is the most commonly known battery measurement.

Cranking Amps (CA) - Measures available current at 32° F and is also called marine cranking amps (MCA).

Depth of Discharge (DOD) - Measures the percent of rated capacity to which a cell or battery is discharged. It is the reciprocal of a battery's state of charge. Example: A battery that has a depth of discharge of 45 percent has a state of charge of 55 percent.

Reserve Capacity (RC) - Measures the number of minutes a fully charged battery can continuously deliver 25 amps at 80 ° F before the voltage drops below 10.5 Volts. This measurement represents the amount of time the battery can operate if a charging system failure occurs.

Electrolyte Specific Gravity (battery test) - Unit of measure which compares the weight of the electrolyte solution to the weight of water. This test is performed with a hydrometer or a refractometer that is made for testing batteries. This type of test is used to determine the battery's state of charge; however, it cannot be used on sealed batteries.

Battery Types

LIQUID LEAD ACID / FLOODED

The Lead Acid battery consists of a plastic container with cells molded into it. Each cell contains plates, lead, and lead oxide (various other elements are used to change density, hardness, porosity, etc.) with 35 percent sulfuric acid and a 65 percent water solution. This solution is called an electrolyte, which causes a chemical reaction that releases electrons.

When testing a battery with a hydrometer, the amount of sulfuric acid in the electrolyte is measured. If the reading is low, the chemistry that makes electrons is lacking. The sulfur is now resting on the battery plates and will remain there until the battery is recharged and the sulfur returns to the electrolyte.

⚠ CAUTION

Use only distilled water to fill flooded / liquid lead acid batteries.

ABSORBED GLASS MAT (AGM) / DRY CELL

The Absorbed Glass Mat battery is just like a flooded battery, except the electricity is maintained in the glass mats, as opposed to freely flooding the plates. Very thin fibers are woven into a mat to increase the surface area to hold sufficient electrolyte on the cells for their lifetime. The construction allows the electrolyte to remain suspended in close proximity with the plate's active material, enhancing both the discharge and recharge efficiency.

When Deep Cycle AGM batteries are not discharged more than 60 percent, the cycle life could be approximately a few hundred cycles. If you do not use or operate your equipment daily, AGM batteries will hold their charge better than most other types. In most cases AGM batteries will provide a greater life span and cycle life than a Wet Cell battery.

AGM batteries are also often referred to as Sealed Regulated Valve, Dry Cell, Non-Spillable, and Valve-Regulated Lead Acid batteries.

⚠ CAUTION

Follow battery manufacturer instructions. Do not add any liquid to AGM batteries.

GEL CELL BATTERIES

The Gel Cell is similar to the AGM battery because the electrolyte is suspended; however, the AGM battery is still considered to be a wet cell. The electrolyte in a Gel Cell has a silica additive that causes it to set (gel) or stiffen. The recharge voltage on this type of cell is lower than the other types of lead acid batteries, due to the likelihood of an adverse reaction to over-voltage charging. Gel Cell batteries are best used in very deep cycle applications and may last longer in hot weather applications.

⚠ CAUTION

Follow battery manufacturer instructions. Do not add any liquid to gel cell batteries.

For more information about Battery Inspection, Safety, Care, and Maintenance, refer to Newgle.

LITHIUM BATTERIES

Lithium batteries are made differently and have several different characteristics from AGM, gel cell, or lead-acid batteries. They charge at different rates, discharge differently, and are affected by temperature differently. For more information on lithium batteries installed in Newmar coaches, refer to the corresponding year and model "Lithium Battery Quick Start Guide" in Newgle. If the coach was not originally equipped with a lithium battery system, Newmar does not recommend, condone, or offer suggestions for battery replacement using lithium batteries.

⚠ IMPORTANT

Newmar coaches are set up, configured, and tested to operate properly with the battery system that was installed at the time of production. Modifications to the battery system may cause charging, electrical system and/or multiplex communication issues. If the coach is not equipped with a lithium battery system, and if you choose to install lithium batteries, Newmar will not warranty or aid in the diagnosis of electrical, battery, multiplex, and/or charging system issues.

Battery Bank Wiring

PARALLEL BATTERY WIRING

Parallel battery wiring refers to two or more batteries with all positive (+) terminals hooked together and all negative (-) terminals hooked together. This results in a battery voltage similar to that of the individual batteries, typically 12 Volt, to boost battery capacity. Two identical batteries wired parallel will provide twice the electrical storage capacity of one battery, without increasing voltage.

SERIES BATTERY WIRING

Series wiring refers to two or more batteries hooked together, with opposite terminals connected. The positive (+) terminal of the first battery should be connected to the negative (-) terminal of the second battery. The resulting voltage is the sum of the individual batteries. For example, if two six Volt batteries are hooked together, the resulting voltage will be 12 Volts.

SERIES/PARALLEL WIRING

Series/ Parallel battery wiring is used on Newmar units when four or more 6 Volt batteries are used for the house battery bank. Since 12 Volts is the desired working voltage from the battery bank, the batteries are connected to provide 12 Volts with more capacity. Two 6 volt batteries wired together in a series create a 12 Volt battery bank.

Two or more of the 12 Volt battery banks can be connected together in a parallel format to provide more capacity.

In situations where multiple batteries are connected in a series, parallel or series/parallel, replacement batteries should be the same size, type, and manufacturer (if possible). Age and usage level should be the same as the companion batteries.

Battery Cycle Vs. Battery Life

A battery cycle is one complete discharge and recharge cycle (100 percent to 20 percent, and then back to 100 percent). Battery life is directly related to how deep the battery is cycled each time. The most common cycles are 10, 20, and 50 percent. Be cautious of ratings that list the number of cycles, unless it also states how low the battery is being discharged.

For example, telephone type (float service) batteries have been advertised as having a 20-year life. However, the rating only stands true at five percent depth of discharge (DOD), and the life span is much less when used in an application where the batteries are cycled deeper on a regular basis. Those same batteries are rated at less than five years if cycled to 50 percent.

If a battery is discharged to 50 percent every day, it will last about twice as long as if it is cycled to 80 percent DOD. If cycled only 10 percent DOD, it will last about five times as long as one cycled to 50 percent. The most practical number to use is 50 percent DOD on a regular basis for the best use of effective storage and cost.

House and Chassis Battery Bank Overview

This article provides a brief overview of the two different battery banks in a Newmar coach: House and Chassis.

Chassis Battery Bank

The Chassis Battery Bank supplies power to everything a customer requires to drive the unit. Currently, Newmar's chassis batteries are all Liquid Lead Acid. Spartan and Ford chassis have serviceable batteries and Freightliner chassis batteries are sealed. The type and brand of chassis battery may vary depending on coach year, make, and model. Chassis batteries may need to be disconnected and removed from the coach to maintain proper electrolyte levels or perform routine battery maintenance. House batteries may be either serviceable Liquid Lead Acid/Flooded or AGM/Sealed Cell.

The chassis batteries on your motorhome are installed and warranted by the chassis manufacturer. The coach (or house) batteries on your motorhome are installed by Newmar Corporation, but warranted by the battery manufacturer. These batteries are used to operate the 12 volt items that are not a direct part of the chassis. Depending on the coach, the batteries may be located in the front of the coach under the front cap or on a pull out tray in an outside compartment.

In addition, there is an upper limit. A battery that is continually cycled down five percent or less will usually not last as long as one cycled down 10 percent. At very shallow cycles, lead dioxide tends to build up in clumps on the positive plates rather than in an even layer.

Battery State/Voltage Chart

State of Charge	Specific Gravity	12 Volt	6 Volt
100%	1.265	12.7	6.3
75%	1.225	12.4	6.2
50%	1.190	12.2	6.1
25%	1.155	12.0	6.0
Discharged	1.120	11.9	6.0

IMPORTANT

This battery state voltage chart is used as an example. Your specific battery manufacturer's chart may vary.

Note: Both voltage and specific gravity tests should be performed with no load on the batteries and without any supplied charging. Turn off all draws and charging. Allow the batteries to stabilize, and then proceed with the test.

CAUTION

Do not use the motorhome with the coach batteries disconnected.



Chassis Battery Bank Example

The chassis batteries are recharged by the vehicle's electrical system whenever the engine is running, with added BIRD, BIM, or Charge bridge solenoids the vehicle's charging system will also charge house batteries if parameters are met. A decline in the coach battery voltage may be noticed while the chassis batteries are being charged.

The converter will automatically charge the coach batteries when the unit is connected to a 120 volt outside power source. The chassis batteries are isolated from the coach batteries, however with certain parameters met the BIRD, BIM, or Charge bridge will activate and allow charge to the chassis battery also. This prevents the chassis batteries from being drained by the interior 12 volt equipment, allowing ample voltage for engine ignition.

House Battery Bank

The House Battery Bank is necessary to operate everything a customer may require in order to live in the unit. These batteries can be either 6 Volt deep cycle (all diesel coaches) or 12 Volt deep cycle, depending on the model and brand of the coach. Newmar house batteries may be serviceable or sealed.



House Battery Bank Example

Battery Boost Switch Overview

This article provides the Newmar-recommended instructions for operating the battery boost switch.

Single Position Battery Boost Switch

The Battery Boost switch is located on the dash and, when pressed, momentarily connects the house batteries to the chassis batteries via the solenoid. This allows the chassis batteries to obtain power from the house batteries to assist in starting the engine.

If the chassis batteries cannot turn the engine over, hold down the Battery Boost switch and attempt ignition. By using the Battery Boost switch while trying to start the chassis engine, the house battery bank supplies a battery voltage boost to the chassis batteries if the house battery bank voltage is higher than the chassis battery bank.

If the battery boost switch is required to start the engine on a regular basis, ask your dealer to check the chassis batteries and charging system.



Dual Position Battery Boost Switch

2019 and newer diesel pusher coaches may have a dual position battery boost switch. This simply allows the chassis battery to be boosted from the house battery bank or the house battery bank boosted from the chassis battery, allowing the solenoid to operate from either source that has power to engage the boost solenoid. Once a click is heard, the solenoid has been energized and the battery voltage will be able to flow from the battery bank with the higher voltage to the battery bank with the lower voltage.

If you're in a situation where battery boost is necessary, press and hold down the switch while trying to start the coach. If the coach still does not start, try holding the switch in the opposite direction, and try again. If this is also unsuccessful in starting the coach, refer to the "Charging House and/or Chassis Batteries" article in Newgle for additional information prior to contacting Newmar for assistance.

Spartan Chassis Battery Overview

This article provides information about a Spartan chassis battery bank.

The chassis battery bank supplies power to everything a customer requires to drive the unit. Currently, Spartan chassis are equipped with serviceable batteries.

The type and brand of chassis battery may vary depending on coach year, make, and model. Chassis batteries may need to be disconnected and removed from the coach to maintain proper electrolyte levels or perform routine battery maintenance.

The chassis batteries on your motorhome are installed and warranted by the chassis manufacturer.

The chassis batteries are recharged by the vehicle's electrical system whenever the engine is running. With an added charge bridge solenoid or BIM, the vehicle's charging system will also charge house batteries if parameters are met.

The inverter/charger will automatically charge the coach batteries when the unit is connected to a 120 volt outside power source and the batteries are connected via the charge bridge or BIM. The chassis batteries are isolated from the coach batteries. This prevents the chassis batteries from being drained by the interior 12 volt equipment, allowing ample voltage for engine ignition.



Spartan Chassis Battery Disconnect Overview

This article provides basic operation instructions for a Spartan Chassis Battery Disconnect. This article contains written instructions, as well as a video demonstration, for this procedure.

The Chassis Disconnect Switches are located in the rear passenger side compartment. There are two switches on a Spartan chassis, and when turned off, they will disconnect most of the chassis battery loads.

When the switches are turned off, the ignition key and most dash components will not operate. To turn the disconnects off, turn both switches to the off position. When placing the coach in storage or when working on the coach engine, turn off the disconnects to disable starting of the engine. To turn on the disconnect switches, flip them to the ON position.



2023 Mountain Aire Lithium Battery Quick Start Guide

This article provides general information, dead battery, and cold start instructions relevant to lithium batteries installed in a 2023 Mountain Aire coach.

Lithium General Information

1. 640 AMP HOURS / 8192 WATT HOURS (TOTAL SYSTEM, 2 PACKS Standard with Lithium option).
 - 320 AMP HOURS / 4096 WATT HOURS (per pack).
 - Aftermarket expandable to 3 packs
2. Battery will not function UNDER -4° F (-20° C) (Internal Battery Temp).
3. Battery will not take a charge UNDER 32° F (0° C) (Internal Battery Temp), but will be usable.
4. Battery will not function OVER 131° F (55° C) (Internal Battery Temp).
5. Battery will not take a charge OVER 113° F (45° C) (Internal Battery Temp), but will be usable.
6. Battery readout on the HOME page is read in State of Charge (SoC) percentage. The voltage can be seen in the DC POWER page and the BATTERIES page of the SilverLeaf touch panel.
7. You can see the status of the Lithium batteries on the HOME screen on the SilverLeaf Touchscreen. A more detailed screen for the Lithium batteries can be accessed from the "BATTERIES" tab at the bottom of the HOME screen.
8. The Lithium can be ran down to a RESERVE CAPACITY shutdown SoC, two times.
9. At the FIRST RESERVE CAPACITY shut down, the battery will turn off but can be restarted by pressing and holding the blue button on the side of each Battery Management System (BMS).

⚠ IMPORTANT

You must make sure to have a charging source for the Lithium batteries after turning them on from the **FIRST RESERVE CAPACITY** shutdown!! If it runs until shutoff without charging it a second time, it will require a Xantrex Technician to come and reset the battery packs at the coach.

10. A charging source is defined as the generator running or the coach plugged in and the Xantrex Freedom SW 3012 inverter/charger on to charge the system.
11. It is recommended to plug into 50A shore power or have the generator running when available to get the full amount of charge to the Lithium batteries.

Storage Temperature and Relative Humidity (RH)

1. Recommended storage Temperature: 59° to 95° F (15° to 35° C).
2. Recommended Storage RH: 45% RH to 75% RH.
3. If the batteries need to be stored for greater than 3 months, the battery SoC should be at least 50%.
4. Battery needs at least one charge and discharge cycle every 6 months.
5. A charge and discharge cycle is defined as a cycle from 100% SoC to 30% SoC to 100% SoC.



Battery Management

1. It is important to maintain the House (Lithium) and Chassis batteries for the motorhome.
2. It is the customer’s primary responsibility to understand and maintain the battery systems in the motorhome.
3. Newmar has added a “COACH MODE” tab on the HOME screen with several scenarios for the customer to choose from depending how they want to set up their coach. These were designed to help the customer in case they were unfamiliar with the setup of specific conditions.

⚠ NOTICE

These are not mandatory to use. The customer can set up everything manually for specific functions and usage.

4. Inside this tab, there are five buttons to choose from. Each has a specific action that will turn ON or turn OFF a system or function to best set up the motorhome for the chosen scenario. To activate any of the buttons, touch the desired button, and then press “ACTIVATE”. This will start the setup of the chosen button. When the setup is complete, all boxes will be checked off beside the corresponding action.
5. There will be a “RING” highlighted around the button that is currently active. If a specific system or function does not activate, it will not check the box or highlight the ring around the button, letting the user know the action did not take place.

Automatic Generator Start (AGS)

1. This system is equipped with an AGS.
2. This AGS system works differently than traditional systems Newmar uses.
3. This AGS is triggered on State of Charge (SoC) and not low voltage for the House Batteries
4. When the House batteries drop to 30%, the AGS will activate and start the generator to begin charging the House batteries.
5. There is no longer an AGS for the chassis batteries.
6. As the chassis batteries deplete, the system will monitor the Chassis batteries. When these batteries get to 12.8 VDC, it will trigger the charge bridge to engage and use the house batteries as a “Maintainer” of the chassis battery. It will stay locked in for 60 minutes, then disengage the charge bridge. It will repeat this scenario as often as the chassis battery drops below the 12.8 VDC. This will happen regardless if there is a charging source for the Lithium batteries or not, down to a set value SoC of the Lithium batteries. Low Chassis voltage will not trigger the generator to start.
7. If no charge source is on the Lithium batteries and the Lithium batteries drop to 30% or less SoC, the system WILL NOT engage the charge bridge for the maintaining of the Chassis batteries. This way the system will save the Lithium batteries when at a lower SoC.
8. The HVAC AGS operates the same as in earlier systems.

Turning on the Lithium Battery Packs after Being Drained to Reserve Capacity

⚠ IMPORTANT

It is the customer's primary responsibility to understand and maintain the battery systems in the motorhome. If one of the applicable scenarios from the COACH MODE button is used, it will aid in the prevention of the batteries from becoming unusable due to cold temps or drained batteries.

1. If the Lithium batteries are off due to draining to reserve capacity, press and hold the blue button on the side of Battery Management System (BMS) located in front of each battery pack in the battery compartment. This will turn on the BMS allowing voltage from the Lithium packs to power the house system.
2. At the FIRST reserve capacity shut down, the battery will turn off but can be restarted by pressing and holding the blue button on the side of the Battery Management System (BMS). When turned on, the word RESERVE will show above the battery SoC percentage until there has been a charge detected on the BMS for 2 minutes, then the RESERVE will disappear.

⚠ IMPORTANT

Make sure to have a charging source for the lithium batteries after turning them on from the first reserve capacity shutdown. If it runs until shutoff without charging it a second time, it will require a Xantrex technician to come and reset the battery packs at the coach.

Cold Start (Lithium Off with Dead Chassis Batteries)

⚠ IMPORTANT

It is the customer's primary responsibility to understand and maintain the battery systems in the motorhome. If one of the applicable scenarios from the COACH MODE button is used, it will aid in the prevention of the batteries from becoming unusable due to cold temps or drained batteries.

1. If internal temp of the batteries are not below -4° F (-20° C), turn ON both Lithium packs.
2. With the Lithium packs ON, hold down the BATTERY BOOST switch, to the left of the steering wheel, on the HOUSE function of the battery boost 2-way switch. This should boost the chassis batteries to similar voltage of the Lithium packs.
3. Start the generator.

⚠ IMPORTANT

Make sure there is adequate ventilation and the coach is not in an enclosed building, if you intend to start the generator.

4. While still holding down the battery boost switch, start the chassis engine.
5. Wait for about 20 seconds so the alternator can start charging, then release the battery boost switch. This should start charging the chassis along with the Lithium packs.
6. Turn on the Oasis and get the Lithium battery temp above 32° F so the batteries can take a charge.

Cold Start (Lithium Batteries Internal Temp Below -4° F (-20° C))

⚠ IMPORTANT

It is the customer's primary responsibility to understand and maintain the battery systems in the Motorhome. If one of the applicable scenarios from the COACH MODE button is used, it will aid in the prevention of the batteries from becoming unusable due to cold temps or drained batteries.

1. If the internal temp of the batteries reach below -4° F (-20° C), you will need to get the internal battery temp above the -4° F (-20° C) before the batteries can be utilized. See "Lithium General Information" above for temperature information.
2. If you have a good chassis battery, start the coach. After starting the coach, start the generator.
3. The Lithium battery system has an "AC SENSE" function that, when the Battery Management System (BMS) are off, and there is AC power available, it will sense that there is AC voltage and turn on the BMS. This may not turn on the batteries IF they are still below the usable temperature but it will turn them on when the temp gets above the -4° F (-20° C) threshold.
4. OPTION 1: Get a space heater (make sure the space heater is not positioned where it could damage any wiring or wire insulation) and warm up either or both of the batteries. When the temp gets just above -4° F (-20° C), if the coach is plugged in or generator is on, the BMS will turn on the power from the Lithium batteries automatically. From there, turn on the Oasis and warm up the battery internal temp above 32° F so the batteries will take a charge.
5. OPTION 2: With the coach started, start the generator. Hold down the BATTERY BOOST switch, located to the left of the steering wheel, on the CHASSIS function of the battery boost 2-way switch. Hold the switch for approximately two minutes. After two minutes, the SilverLeaf will engage the charge bridge on its own and the coach will stay powered. This will boost the HOUSE circuit to be able to run the Oasis on the burner from the chassis so the batteries can warm up.

House Battery Disconnect Overview for Diesel Pushers

This article provides basic operation instructions for a house battery disconnect switch.

The House Battery Disconnect Switch (labeled “Batt. Disc.”) is used to control the disconnect relay connected to the battery bank and is typically located in the passenger side console. This switch disconnects most loads when placing the coach in storage or when the coach is not in use. This is done to prevent the coach batteries from being drained during storage.

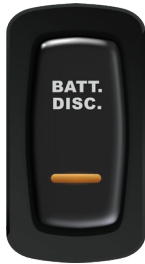

Not all loads are disconnected, and, depending on the coach and its options, some systems may have memory circuits purposely not wired to the disconnect solenoid, including, but not limited to, the LP detector (if equipped), driver memory controls, and other memory-based features.

In addition, the inverter is typically not on the disconnect and will need to be powered off separately. This allows the inverter to charge the batteries when plugged into shore power with the battery disconnect turned off.

Some switches have a shield on the sides to help prevent accidental battery shutdown when trying to operate the baggage door lock switch.

To operate the battery disconnect:

1. Press up on the rocker switch to turn on the disconnect and reconnect the batteries. This will make the 12 volt system ready for use. When the battery disconnect is turned on, the indicator light will illuminate.
2. Press down on the rocker switch to turn off the battery disconnect and disconnect the batteries. When the battery disconnect is turned off, the indicator light will also turn off.

Battery Inspection, Safety, Care, and Maintenance

This article provides information regarding the inspection, care, and maintenance for coach batteries. Battery maintenance is an important issue often overlooked by many RV owners and technicians. As batteries age, their maintenance requirements change. This means longer charging time and/or higher finish rate (higher amperage at the end of the charge). Usually older, serviceable (unsealed) flooded batteries need to be watered more often, as their capacity decreases over time.

Safety Guidelines

⚠ WARNING

Prior to handling or working with a lead-acid battery, consult your battery owners’ manual for instructions and safety precautions.

⚠ CAUTION

Disconnect the 120 volt electrical power cord and the negative terminal from the coach batteries, and make sure all power sources are disable (ignition, generator, shore power, inverter) before working on the electrical system.

⚠ WARNING

Remove rings, metal watch bands, and other metal jewelry before working around batteries. Use caution when using metal tools. If a tool contacts a battery terminal or metal connected to it, a short circuit could occur, which could cause personal injury, explosion, or fire.

- Wear ANSI (American National Standards Institute) approved safety glasses or goggles, as well as a face shield.
- Wear proper clothing to protect your face, hands, and body.
- Work in a well-ventilated area.
- Never lean over a battery while boosting, testing, or charging.
- Keep all ignition sources away from the battery. Cigarettes, flames, or sparks could cause a battery to explode.
- Always shield eyes and face from the battery.
- Do not charge or use booster cables or adjust post connections without proper instructions and training.
- Keep vent caps tight and level.
- In the event of an accident, flush eyes or skin with water, and call a physician immediately.
- Keep out of reach of children.

Lead-acid batteries contain hydrogen-oxygen gases that may be explosive and sulfuric acid that may cause severe burns. To avoid injury, observe these precautions when handling or working with a lead-acid battery:

Common Causes Of Premature Battery Failure

- Deep discharges (leaving your lights on)
- Misapplication
- Replacement using an undersized battery not meeting Newmar’s OEM specifications

- Loss of electrolyte due to overheating or overcharging
- Undercharging or loose alternator belt
- Excessive vibration (due to loose clamp or hold down on battery)
- Corrosion
- Freezing (A fully-charged vehicle battery will not freeze until the temperature is -75° F. Frozen batteries are not warrantable.)
- Failure to charge a battery during a period of six months or more (Inactivity can be extremely harmful to all lead acid batteries.)

Cleaning The Batteries

Check the vent plugs and replace them if they are cracked or broken. Keep the battery clean. Accumulations of acid film and dirt may permit current flow between the terminals, which could drain the battery.

To clean, wash the batteries with a diluted solution of baking soda and water to neutralize any acid present. This should be a mixture of a couple of tablespoons of baking soda per pint of water. Rinse thoroughly with clean water. Foaming around the terminals or on top of the battery is a sign that acid is being neutralized. Avoid getting the baking soda solution in the battery. Secure all vent caps.

Both house and chassis battery cable connections need to be cleaned and tightened, as battery problems are often caused by dirty and loose connections. Dry the battery cables and terminals to prevent corrosion. Do not use grease on the bare metal inside the cable terminals. Grease can act as an insulator, and electricity will not flow through it. A plastic ignition spray will protect the terminals after they have been cleaned.

WARNING

Do not allow the battery fluid to contact your skin, eyes, fabric, or painted surfaces. The fluid could cause serious personal injury or property damage. Wear eye protection when working with any battery.

Storing The Batteries

Remember that when batteries are not used for an extended period of time, they may lose their charge. Periodic charging of the batteries during storage of the unit will increase the life of the battery. Check the external condition of the battery periodically. Look for cracks in the cover.

The batteries should be removed and stored in a warm place when not using your motorhome for an extended period of time. This will prevent unnecessary drain and corrosion of the batteries. The coach batteries are 6 volt RV/Marine deep cycle batteries. Mark the cables, positive and negative, for easy identification. Batteries are not to be stored on concrete floors.

Preventing Corrosion

Newmar sprays the battery connections once they are tightened with a battery protector and sealer to help prevent corrosion. When performing battery maintenance, you should reseal the battery terminal connections. The following measures may also prevent future corrosion:

Use a small bead of silicone sealer at the base of the post where it meets the battery case. Place a felt battery washer over the post and into the bead of silicone. Coat the washer with high temperature grease or petroleum jelly (Vaseline), then place the cable on the post and tighten. Coat the exposed cable end with the grease. The gas condensation on metal parts of the battery cause most corrosion issues.

Checking The Fluid Level and Adding Fluid

A serviceable battery needs to have the fluid level checked, as they consume water and must be filled periodically. Please be sure to check the battery water level on a regular basis.

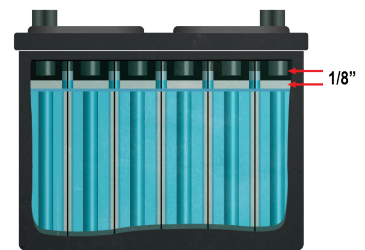

1. A serviceable battery needs to have the fluid level checked. AGM batteries do not require additional fluid. If the battery has removable vent caps, they can be twisted or pried off with a flat-head screwdriver. Once removed, the individual vent wells can be seen. Look down into each individual cell to make sure that the water is covering the lead plates and is at the proper level.
2. Add water to any cells that are low on water. Ideally, the water level should be 1/8" below the bottom of the tubes (there are six tubes in a 12 Volt battery) that go down into the battery. To avoid damage to the battery, make sure the fluid level never drops below the tops of the lead plates in each of the cells. Always use distilled water to fill the battery to prevent battery contamination.
3. Do not overfill battery cells. Adding too much water may result in acid overflow and damage around the battery. In addition, warmer weather may cause natural fluid expansion, forcing excess electrolytes from the battery.

CAUTION

Use only distilled water to fill flooded / liquid lead acid batteries. Non-serviceable (AGM, Gel Cell) batteries do NOT require the addition of ANY liquid. Adding liquid to non-serviceable AGM or Gel Cell batteries will result in damage to the batteries and will not be covered under warranty.

Battery Replacement Recommendations

This article provides information about general battery location and replacement recommendations.

On diesel coaches, the house batteries are normally located in one of the lower compartments. The chassis batteries are normally on the passenger side in the rear compartment on diesel pushers and under the driver's side cab on the front engine on Super C coaches. On coaches built on a Ford chassis, batteries are normally located in the front of the coach and can be accessed by opening the hood.

A battery wiring label is located inside the battery compartment and shows how the batteries are wired together. Replacement batteries must be wired according to the diagram shown. Replacement batteries should be of the same brand and capacity as the originals.

Any time one battery is replaced, it is important to test the rest of the batteries in the system to make sure they are still functioning properly and efficiently. If one defective battery is replaced, while leaving another weak or defective battery, lowered performance, or ultimately damaging the new or good batteries, may result.

⚠ IMPORTANT

Charging batteries release gasses as the fluids inside boil, so it is critical to check the battery fluid levels regularly, particularly after extended periods of heavy use. Be sure to top off any battery that is showing signs of depleted fluid levels.

⚠ IMPORTANT

Newmar coaches are set up, configured, and tested to operate properly with the battery system that was installed at the time of production. Modifications to the battery system may cause charging, electrical system and/or multiplex communication issues. For example, if the coach is not equipped with a lithium battery system, and if you choose to install lithium batteries, Newmar will not warranty or aid in the diagnosis of electrical, battery, multiplex, and/or charging system issues.

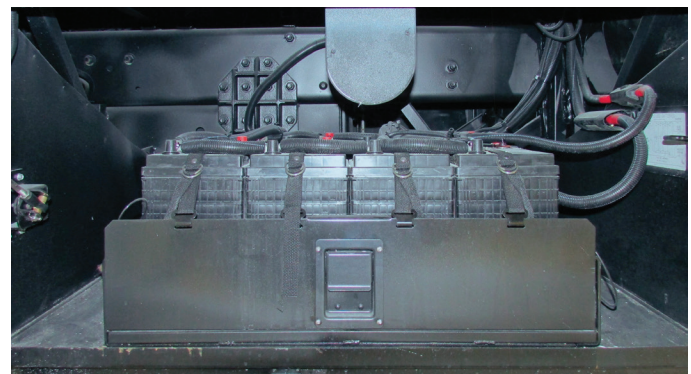

For More Information

For more information about coach battery basics, as well as other inspection, safety, and care and maintenance recommendations, refer to other articles in Newgle.

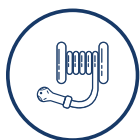

Shore Power Cord and Cord Reels

Shore power is supplied to the coach via a power cord. When equipped, a cord reel provides the ease and convenience of storing the shore power electrical cord in a neat and compact space with the assistance of motorized retraction.

Cord Reel Overview

This article provides an operational overview of the shore power cord reel and switch.

Cord reels (when equipped) provide the ease and convenience of storing the shore power electrical cord in a neat and compact space with the assistance of motorized retraction. On coaches equipped with a power cord reel, pull out the power cord, and plug it into an appropriately rated electrical outlet. Make sure the power source is providing the correct voltage before plugging in the shore cord.

To store the cord, disconnect it from the power source outlet. Remove the cord from the pocket in the compartment, and press and hold the momentary switch to retract and roll up the power cord as needed. The switch is typically located on the cord reel or on the compartment door.



Glendinning Cablemaster Power Cord Reel Operation (Model: CRR-50)

This article provides brief operation instructions for a Glendinning Cablemaster Power Cord Reel (Model: CRR-50).

Operation

To extend the power cord:

1. Pull out sufficient cord length that will allow you to route shore power cord to the electrical distribution box.
2. Plug the molded end into the receptacle.



To retract the power cord:

1. Detach plug from receptacle using lever on plug.
2. Press and hold the button and the power cord will automatically retract (CAUTION — it is advisable to monitor the progress of the power cord as it retracts and stores onto the reel).

Maintenance

Experience has shown that when only a short section of power cable is regularly used, the cable may be subject to “kinking”. To relieve this condition, routinely extend the power cable completely and stretch it on any smooth surface. Allow the Cablemaster to retract the cable onto the reel. At least once a year, inspect all AC and DC wiring connections and make sure they are free of corrosion and connections tight.

Periodically inspect the exterior jacket of the power cable for nicks or cuts. If your power cable is dirty, any cleaner should be compatible with the outer jacket material of the power cable.].

Source(s): Cablemaster CRR-50 Manual: Installation and Operation Instructions

Product(s): Glendinning Cablemaster 50 Amp Power Cord Reel w/50' Power Cord (Model: CRR-50, Newmar Part Number: 116690)



Energy Management Systems

This article provides an overview of the energy management systems used by Newmar.

The energy management and auto generator start systems work behind the scenes to monitor the power supply and demand within the coach. The system is designed to minimize the occurrence of tripped breakers for shore power and the generator while heavy loads are being used. The system turns off other loads temporarily while heavier loads are in use and restores power when heavy loads are turned back off.

NOTICE

Whenever possible, connect coaches equipped with 50 amp shore power cord to 50 amp service, and connect coaches with 30 amp shore power cords to 30 amp service accordingly. It is the best practice to avoid using adapters and cheater cord devices.

When 50 amp service is available, no action is required; however, 30 amp service (or less) requires setting the value of incoming power to be selected.

Auto generator features may vary by coach model and options. Most AGS systems start the generator if shore power is unavailable and the HVAC system signals for air conditioner operation. Many systems will also start automatically if battery levels reach the preset values.

For more information about the energy management system, refer to the SilverLeaf Coach Management or Precision Circuits Power Control System documentation found in Newgle, depending on which system is installed in the coach.



Fuse Panels

This article provides information and the location of the house and chassis fuse panels.

Fuse Panels On Coaches Built On A Spartan or Freightliner Chassis

Inside The Coach

On a diesel pusher coach, the house fuse panel, which controls most of the components and appliances inside the coach, is located in the bathroom, in the front overhead next to the 120 volt breaker panel, or in the rear wardrobe. This panel contains fuses and breakers that are connected to the main appliances in the coach, from the refrigerator and television to the lights in the bedroom and slideouts.

There are also some external components that are fused in the house fuse panel. For example, the fuses for the water pump, water heater, security lights, and basement storage lights may be located in this panel.



Diesel Pusher Fuse Panel Example

Outside The Coach

House battery and disconnect fuses are located in the compartment with the shore power cord. This fuses control the battery boost, battery disconnect, keyless entry, hydronic heat, LP detector, and entrance steps. In this same location, there are also 12 volt circuit breakers that provide power to the house fuse panel, slideout motors, power awnings, and the entry step.

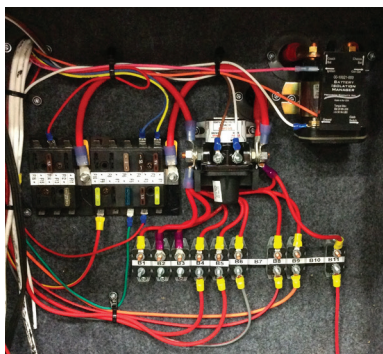

Shore Power Compartment Fuse Example

The Freightliner and Spartan chassis fuse panels are located in the left front baggage compartment under the driver's seat.



Freightliner Fuse Panel Example

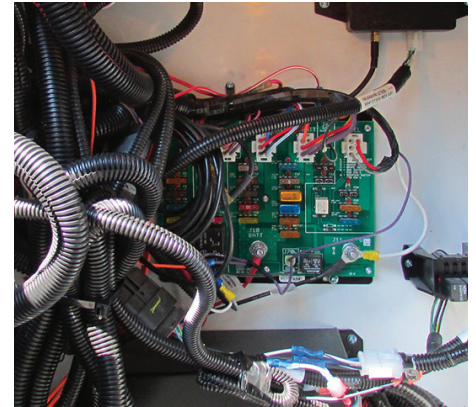

Spartan Fuse Panel Example

An additional chassis circuit fuse panel is located in the chassis battery compartment on the rear passenger side of the coach. Both the Freightliner and Spartan chassis manuals contain detailed information on what fuses are located in these panels.

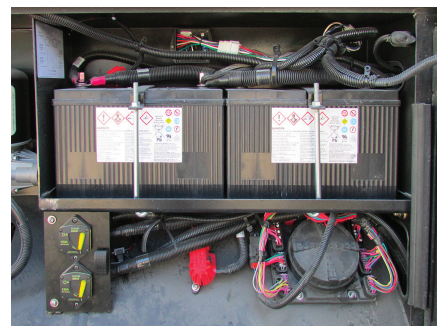

Spartan Chassis Fuse Panel Example

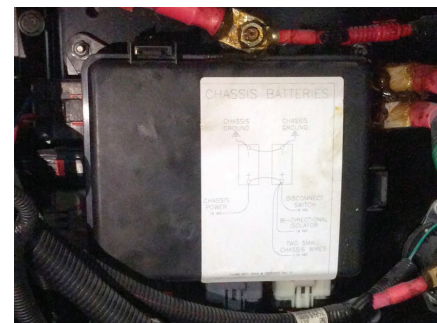

Freightliner Chassis Fuse Panel Example

KIB 12 Volt Fuse Panel

The Newmar KIB fuse panel is also located in the left front baggage compartment under the driver's seat. This panel contains fuses that power the dome light, front visor, and the solar panels (late 2015 model year), as well as for the entrance step, back-up monitors, navigation, cargo lights, and keyless entry. The ignition lock-out for the slideouts and shades is also located on this fuse panel.

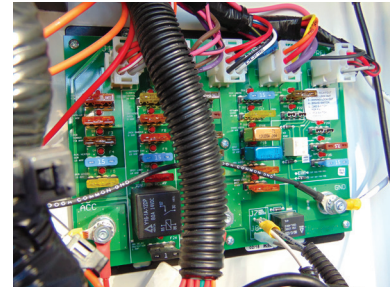

Example of a KIB Fuse Panel



Generators

This article provides information for maintenance, operation, and safety for gas and diesel generators.

Generator Compartment Overview

This article provides an overview of the generator compartment.

Select coach models are equipped with a powered generator slide compartment to provide easier access to the generator, fire wall, and other components located below the dash between the front cap and the firewall.

Do not place anything in front of or between the slide area of the front bumper and cap, including persons, while in operation or during service of the slide system.

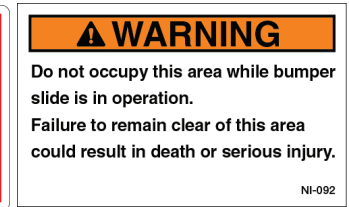

Generator and GenStart/Stop Switch Overview for Diesel Coaches

This article provides basic operation instructions for a generator and GenStart/GenStop switch on a diesel coach.

The generator is wired into the Automatic Transfer Switch and will power all of the 120 volt circuits in your coach. Your generator may be located in a side compartment or in the front of the coach in between the frame rails of the chassis. Some generators are mounted on slides for easy access and may need to be unlocked before free movement is allowed. The main breakers for the output legs are located on the generator start panel.

Operation

The generator can be started from the rocker switch on the dash, from other remote start switches (if equipped), from the start switch on the generator itself, or from the SilverLeaf touchscreen (if equipped).

The generator in your coach runs on the same diesel fuel as your main engine. The diesel fuel is drawn through a separate supply tube that is positioned in the tank in a manner that will not allow the generator to draw fuel and run if the tank level dips below the ¼ level.

Depending on the ambient temperatures, the generator may pre-heat prior to cranking. This pre-heat condition is noted by flashing the light on the generator start switch until the cycle is complete (up to 15 seconds). Once it has pre-heated sufficiently, the starter will engage and the engine will start.

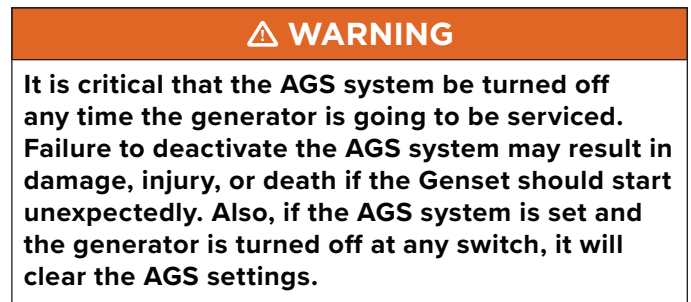

BEFORE STARTING THE GENERATOR:

1. Turn off the air conditioners and any other large electrical loads, as recommended by the generator manufacturer.
2. If the generator previously ran out of fuel, add fuel to the tank.
3. Prime the generator by holding the generator switch in the stop position.

TO START THE GENERATOR:

1. Press and hold the generator start switch in the "Start/Preheat" position. It will automatically delay and pre-heat.
2. The indicator light will flash rapidly while pre-heating, and the generator will crank and start.

3. When the generator starts, release the switch.
4. The indicator light will stay illuminated while the generator is running.

TO STOP THE GENERATOR:

1. Press the generator switch in the “Stop” position.
2. Release the switch.
3. The indicator light will turn off when the generator stops.

Service Required Indicator:

1. The generator switch indicator light may flash in a series of three quick flashes, followed by a short pause, and then quickly flash three more times. These flashes indicate that service is required.
2. Refer to the owner’s manual for your specific generator for more in-depth descriptions of flashing codes.

⚠ IMPORTANT

Excessive cranking can damage the starter motor. Do not crank the generator more than 30 seconds at a time, and allow at least two minutes before trying again if the first attempt fails.

⚠ CAUTION

Failure to turn off the 120 volt appliances when starting or stopping the generator may damage the transfer switch and/or electrical appliances.

⚠ NOTICE

If your coach contains an Energy Management System, 8kw generator, and three roof air conditioners, the combined load may exceed the capabilities of the generator. Please remember to turn off one of the air conditioners as the 8kw generator is not intended to run all three roof air conditioners at the same time.

⚠ DANGER	⚠ DANGER
Vehicles and equipment powered by internal combustion engines and placed in recreational vehicles can cause carbon monoxide poisoning or asphyxiation, which could result in death or serious injury. The flammable liquids used to power these items can cause a fire or explosion, which can result in death or serious injury. To reduce risk: a) Do not ride in the vehicle storage area when vehicles are present. b) Do not sleep in the vehicle storage area when vehicles are present. c) Close doors and windows in walls of separation (if installed) when any vehicle is present. d) Run fuel out of engines of stored vehicles after shutting off fuel at the tank. e) Do not store, transport, or dispense fuel inside this vehicle. f) Open the windows, openings, or air ventilation systems provided for venting the transportation area when vehicles are present. g) Do not operate propane appliances, pilot lights, or electrical equipment when motorized vehicles are present.	Les véhicules et l'équipement propulsé par un moteur à combustion interne placé dans un véhicule de camping peuvent causer un empoisonnement au monoxyde de carbone ou l'asphyxie, ce qui pourrait entraîner des blessures graves ou la mort. Les liquides inflammables utilisés pour propulser ces machines peuvent causer un incendie ou une explosion, ce qui peut entraîner des blessures graves ou la mort. Pour réduire le risque: a) Ne pas circuler dans l'aire de rangement du véhicule si des véhicules s'y trouvent. b) Ne pas dormir dans l'aire de rangement du véhicule si des véhicules s'y trouvent. c) Fermer les portes et fenêtres qui se trouvent dans les cloisons (le cas échéant) si au moins un véhicule est entreposé. d) Épuiser le carburant contenu dans les moteurs des véhicules entreposés après avoir coupé l'alimentation en carburant au réservoir. e) Ne pas entreposer, transporter ou distribuer de carburant à l'intérieur de ce véhicule. f) Ouvrir les fenêtres, ouvertures ou systèmes de ventilation d'air fournis pour ventiler la zone de transport lorsque des véhicules s'y trouvent. g) Ne pas faire fonctionner d'appareils au propane, de veilleuses ou d'équipement électrique en présence de véhicules motorisés.

Generator Start via SilverLeaf HMS-404 Display

This article provides overview of the SilverLeaf Tank Monitoring System (HMS404) typically located in the water compartment. Starting with the 2022 model year, the SilverLeaf system includes an HMS404 panel installed in the water compartment instead of an SPX300 monitor.

⚠ NOTICE

This information is generic in nature and may not be specific to your exact coach model and/or year. Some features shown may not be available on all coach years, models, and/or floorplans.

Genset

The Genset screen (if equipped) displays the current generator information, generator run hours, engine RPM, and engine temperature. Press the Genset button to manually start or stop the generator.

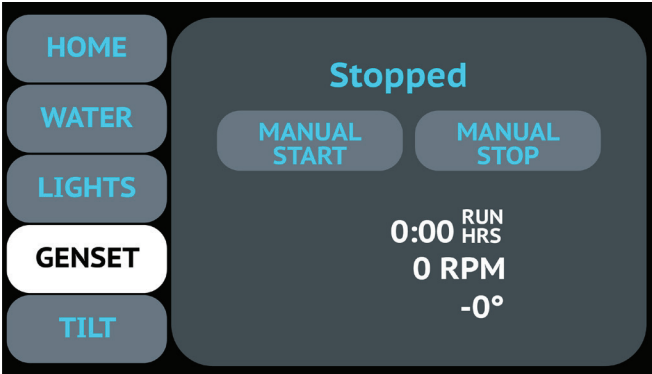

HWH Hydraulic Generator Slide Operation

This article provides an operational overview of the HWH hydraulic generator slide.

To Open The Generator Slide:

1. Turn on the ignition key.
2. Open the compartment located in front of the first wheel on the driver’s side.
3. Locate the generator slide switch.
4. Press and hold the switch in the “extend” position until the generator slide reaches the desired position or maximum extension.

To Close The Generator Slide:

1. Turn on the ignition key.
2. Open the compartment located in front of the first wheel on the driver’s side.
3. Locate the generator slide switch.
4. Press and hold the switch in the “retract” position until the generator slide is fully retracted.

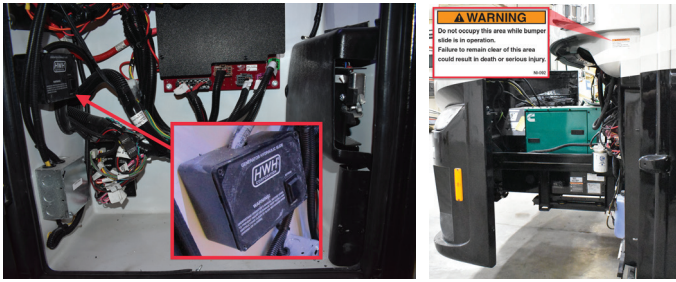

⚠ WARNING

Do not occupy this area while bumper slide is in operation. Failure to remain clear of this area could result in death or serious injury.

Generator Maintenance

Before starting your generator for the first time each day, and subsequently after each eight-hour run cycle, perform the following checks to make sure it is ready to be used.

1. Make sure the carbon monoxide detectors in your unit are working.
2. Check for signs of fuel or exhaust leaks.
3. Make sure there is adequate clearance around the generator for proper ventilation. Also check for sloping ground or any other obstructions that may have occurred. Tall grass or other items that come in contact with the generator may interfere with ventilation or cause a fire.
4. Check the oil and coolant levels, and inspect for leaks.
5. Check the battery connections to make sure they are tight and clear of corrosion.
6. Inspect the generator compartment for road debris or damage that might affect the performance or safety.
7. Turn off major appliances (such as air conditioners, televisions, and other electronics that may excessively load the generator or may be sensitive to initial voltage surges).

The hour meter installed on the generator calculates the number of running hours of the generator motor. This is used for maintenance schedules. Regular oil changes and other maintenance performed at the prescribed intervals will greatly extend the life of your generator.



Inverters and Converters

Provides basic information about the role and operation of inverters, converters, and inverter/converter combination units.

Inverters

The inverter modifies direct current to alternating current to provide power to specified appliances and entertainment systems. The inverter performs this action by using a transformer to increase the voltage and modify the higher voltage into a useable alternating current power. For this function to occur, the inverter must be powered, set up, and turned on. A variety of inverters are used by Newmar; however, most have a control panel located in the overhead cabinet with other switches and controls.

Converters

A converter transforms alternating current or shore line power 120 volts; to low-voltage direct current to provide power to the coach's 12 volt house and chassis batteries. This function occurs automatically when 120 volts are supplied to the converter. Converters are usually located in the cord compartment of coaches that do not have a inverter/converter combination unit.

Inverter/Converter Combination Units

The inverter/converter combination provides battery charging and allows the 120 volt power from shore power or the generator to pass through the inverter. The inverter performs this charging action by using the transformer to decrease the voltage and rectify the alternating current into useable direct current voltage. This is regulated by internal-sensing circuitry based upon the battery bank's state of charge and several other factors, depending on the coach's particular inverter brand and type.

This type of unit also performs the inverter function. For this function to occur, the inverter must be powered, setup and turned on. A variety of combination units are used by Newmar; however, most have a control panel located in the overhead cabinet with other switches and controls.

Xantrex Freedom SW 3,000 Watt True Sine Wave Inverter Operation (Model: FSW3012)

This article provides basic operation instructions for a Xantrex Freedom SW 3,000 Watt True Sine Wave Inverter (Model: FSW3012).

The Freedom SW Inverter/Charger is a true sine wave inverter/charger that can be used for mobile, marine and commercial applications. The Freedom SW Inverter/Chargers are designed to operate with a wide variety of generators and are capable of operating in parallel with a generator for short durations to assist with starting large loads. The Freedom SW is a convenient combination of an inverter, multistage battery charger, and transfer switch in one electronic device.

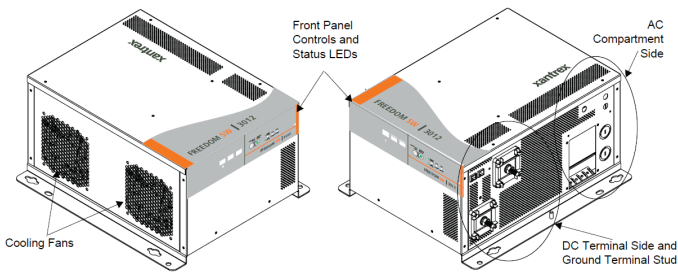

Inverter Operation Using The Front Panel

Once the inverter/charger is installed, you can operate it in invert mode. To operate in invert mode from the front panel:

1. Press the INVERTER ENABLE button on the Freedom SW on the front panel. The INVERTER ENABLED LED turns on and connected loads will be energized.
2. Note that if AC is present and being passed through, the INVERTER ENABLED LED will still turn on to indicate inverter mode has been enabled. However, AC will continue to be passed through to the loads until conditions exist that cause AC to be disqualified, in which case the unit will transition to invert mode and power up critical loads.
3. Connect AC input power. The charger automatically starts up when qualified AC power is connected.
4. Disconnect AC power from inverter input by opening the breaker or disconnect.
5. Place a load on the inverter. For example, plug a 100-watt light bulb into an outlet that the inverter is powering. Press the INVERTER ENABLE button on the Freedom SW. The INVERTER ENABLED LED turns on. The inverter should run the load using battery power.
6. To test the charger, reconnect the AC input power to allow AC to the AC input. The AC In/Charging LED should start flashing after a brief delay. Any AC loads previously powered by the inverter will also work at this time.

- NOTE: On dual input models, only AC Input L1 needs to be powered for the unit to operate.
7. Remove the AC input power. The inverter/charger should transfer to invert mode immediately. (The transfer relay will make a clicking sound and the INVERTER ENABLED LED will turn on.) Loads should continue to operate uninterrupted. If any part of this test fails, determine the cause before using the unit.
 8. Monitor the Freedom SW Front Panel. The indicator LEDs on the front panel show you the operating status of the Freedom SW. A description of the LEDs is provided. If none of the front panel LEDs are on, refer to the “Troubleshooting” section in Xantrex’s Owner’s Manual.

Front Panel LEDs

LED Label	Color	Status	Action (or Status Item)
Inverter Enabled	Steady Green	If utility and generator AC is unavailable and operating conditions are met, the Freedom SW will produce AC voltage to power loads.	You can run your appliances from the inverter.
Gen Support	Flashing Green	The inverter is assisting a generator in powering loads.	You can run your appliances from the inverter.
AC In	Steady Green	When the Freedom SW is connected to a qualified AC source or a generator, the AC IN LED turns on.	You can run your appliances from an AC source like the utility grid or a generator.
Charging	Flashing Green	Freedom SW is connected to a qualified AC source, is charging and passing power to AC loads.	Your battery bank is being replenished and AC loads are receiving power.
Fault	Steady Red	A fault condition was detected on the network.	Investigate and clear the fault condition.
Warning	Flashing Red	A warning is detected.	Investigate by examining warning logs on SCP.

Freedom SW AC and DC Side Panels

If AC output or passthrough voltage issues exist, check the circuit breakers located on the side panel and reset if necessary.

The DC side of the Freedom SW has the equipment ground plug, the positive (+) battery terminal, and the negative (-) battery terminal plus the remote network com port and battery temperature sensor com port.

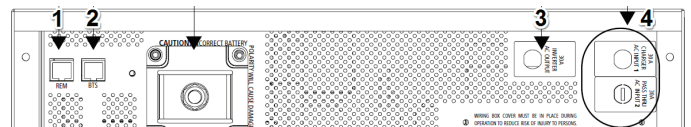

1. Remote (REM) jack provides connection for the Freedom Sine Wave remote panel.
2. Battery temperature sensor (BTS) jack provides connection for the battery temperature sensor (supplied).
3. AC Output circuit breaker reset button
4. AC Input circuit breakers reset buttons.

Inverter Operation Via Silverleaf

On most Newmar coaches, the inverter is controlled via the SilverLeaf touchscreen. For more information, refer to the DC Power portion of the SilverLeaf touchscreen guides in Newgle.

Faults and Warnings

A fault affects the operation of the unit. A manual fault requires user intervention by clearing the condition and then pressing the CLEAR FAULT RESET button on the inverter/charger's front panel. A warning alerts you to a condition that could possibly affect operation of the unit.

Source(s): Xantrex Freedom SW Sine Wave Inverter Owner's Guide

Product(s): Xantrex Freedom SW 3,000w True Sine Inverter (Model: FSW3012, Newmar Part Number: 125516)



Lighting

A Newmar coach's electrical and lighting system is designed for maximum reliability, functionality, and style.

Interior and Exterior Lights

Provides basic information about operation, maintenance, and replacement of interior and exterior lights.

Interior Lights

A Newmar coach's electrical and lighting system is designed for maximum reliability, functionality, and style. Your coach may feature traditional on/off switches or multi-switch touch panel light and accessory switch panels. Located throughout the unit, these switching devices are used to turn lights on and off, as well as to operate power shades and window treatments. Many coach models boast LED accent lights and LED wall sconces custom-designed for Newmar.

Flip the switch or touch the switch panel to operate the light or accessory you desire. Some lights may also have dimming features, allowing you to adjust the interior lighting for mood or comfort. For more details about the interior lights, refer to the documentation in Newgle.

Many of these bulbs are made as both filament and LED. Most LED bulbs are polarity-sensitive unlike filament bulbs. When attempting to replace filament-type bulbs with LED-type bulbs, it is possible for the light fixture to be wired in reverse polarity for the LED replacement bulbs. Switching to a different type of bulb may require a wiring change. Newmar recommends any wiring modifications be performed by an authorized service technician.

IMPORTANT

When replacing halogen bulbs, do not touch the bulb, as the oil from your hands will reduce the bulb's life.

Turn off the lights to avoid possible short circuits, blown fuses, and burns while removing and replacing bulbs or lights. Depending on the year and model of your coach, it may be equipped with LED light fixtures with the lights embedded into the light housing.

Many of the LED light fixtures have integrated LED assemblies that are non-serviceable and non-replaceable. When LED light bulbs burn out in this type of fixture, the complete light must be replaced. Replacement bulbs or light fixtures are available for purchase through the Newmar Parts Department.

WARNING

Do not substitute bulbs just because they will fit, as it may cause overheating, back feed, or damage to the light fixture or lens.

Exterior Lights

Replace any exterior light bulbs or fixtures as needed to maintain DOT safety requirements. When servicing interior or exterior lights, make sure you replace any light bulb with the same bulb number (normally stamped on the base of the bulb or printed on the bulb). Replacing the bulb with the identical part number will ensure the wattage and base are the same.

The coach may have headlights installed that are atmospherically vented, so condensation may occur in these headlight assemblies. Under normal driving conditions with the headlights turned on, the condensation will dissipate, allowing it to escape through the vent.

IMPORTANT

Always check the operation of all headlights, turn signals, and clearance lights prior to traveling.

It is necessary to keep exterior lights clean, as dirty lights have diminished output and reduced visibility. To clean your exterior lights, use a mild soap designed for automotive car washing. Avoid using harsh cleaners, abrasive products, and petroleum-based products or other chemicals.

Lighting Operation via KIB LCD Touchscreen

This article provides brief operating instructions for a KIB LCD touchscreen.

Operation

Touch the inactive (blank) screen to activate and display the Lighting screen. Once the panel becomes inactive and times out, it will default back to the blank screen. Touch the Home icon to reveal the Home Menu page, which may include buttons for lighting, shades, fans, systems, or display brightness controls, as well as an icon in the upper right corner for More Information (i). Once a button is touched, it will turn red, indicating the circuit is active. The buttons are gray while the circuit is inactive.

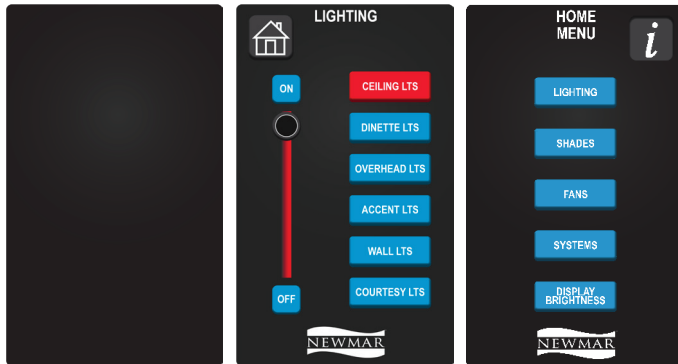

buttons will vary by coach model and floorplan, as well as installed options. Potential buttons may include, but are not limited to:

- CEILING LTS
- BATHROOM LTS
- BEDROOM LTS
- WALL LTS
- MIRROR LTS
- VANITY LTS
- ACCENT LTS
- COURTESY LTS
- ALL LIGHTS ON
- ALL LIGHTS OFF

The All Lights On/Off buttons toggle all lights on and off in the coach at once.

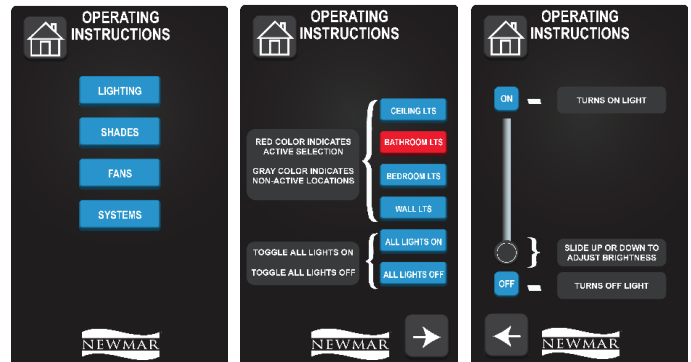

Lighting

Once a function is selected, such as Lighting, the screen will display additional buttons pertaining to the area in which the panel is mounted. The available

Touch the ON button to turn on the selected light circuit. Touch the OFF button to turn off the selected circuit. On lighting circuits with dimming capability, drag the slider to adjust the brightness of the selected light circuit.



Receptacles and Accessory Chargers

Newmar coaches are framed 16 inches on center, allowing the best placement of outlets, switches and other components.

120 Volt Outlets

This article provides information about the 120 Volt outlets located throughout the interior of the coach.

Several 120 volt receptacles are located throughout the interior of the unit. These receptacles require three-pin plugs that provide proper grounding to protect you from electrical shock. The breaker for the outlets are usually located in the breaker box. If the breakers are on the inverted circuitry, they will be located in the subpanel near the main breaker box.



⚠ IMPORTANT

Do not use an adapter, cheater, or extension cord that breaks the continuity of the ground circuit to the ground pin. Never remove the ground pin from a plug in order to connect it to a two-pronged ungrounded outlet.

Ground Fault Circuit Interrupt Outlets (GFCI)

This article provides an overview of the purpose and function of a GFCI outlet.

The Ground Fault Circuit Interrupt (GFCI) outlets protect the user from ground faults between a hot wire and ground. The 120 volt electrical outlets in the kitchen and bath area are GFCI-protected receptacles.



⚠ IMPORTANT

This information is generic in nature and IS NOT specific to your coach. The exact location of GFCI outlets vary by year, model, and floorplan and/or component options. The following location descriptions and images are for example use only.

Location Tips and Examples

The electrical outlets located in the slideouts are typically wired through the kitchen GFCI. The exterior electrical outlets are typically wired through a bathroom GFCI.

On coaches equipped with the floor heat option, separate GFCI(s) are installed in a bathroom, cabinet, or closet and/or near the main breaker box. Some may be difficult to find and may require using a flashlight while looking inside cabinets.

Coaches with the holding tank heat pad option will have an additional GFCI located in the basement area; however, the exact location varies.

Note: Any component that gets plugged into a GFCI-protected circuit will not operate if the GFCI has tripped. In some cases, this may include other components and/or options installed, such as powered theater seating.

⚠ IMPORTANT

Newmar recommends checking and resetting all GFCI outlets and 120 volt breakers, as well as replacing any blown 12 volt fuses when component(s) are inoperable.

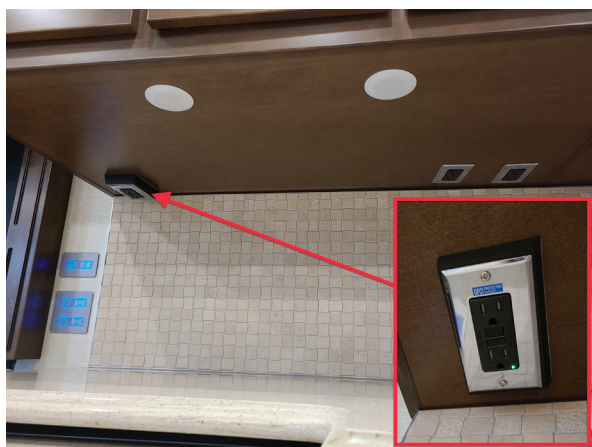

Testing The GFCI Outlets

The GFCI outlets should be tested at least once a month. The reset button needs to be pressed before starting the test.

1. The GFCI outlet must be supplied with 120V power for testing and general use.
2. Pressing the Test button on the GFCI outlet will trip and cease to supply power to the outlets on the GFCI, as well as any other outlets that are hooked up downstream of the GFCI outlet.
3. Pressing the Reset button will reset the GFCI outlet and all outlets downstream of the outlet. Some GFCI outlets may have a LED light as a visual indicator of the power status.
4. If a tripped GFCI outlet will not reset, disconnect everything plugged into them or hooked up downstream; then try resetting the GFCI again.
5. If all loads are disconnected and 120V power is present to the GFCI outlet and the GFCI outlet will still not reset, it may require service or replacement by a qualified technician.

If the GFCI is working properly, the reset button will remain in the "IN" position. If an item plugged into a slideout or outside receptacle is not working, check for a tripped GFCI in the kitchen or bathroom. Likewise, if the floor heat or holding tank heat pads are not working, check the GFCI for that circuit.

⚠ WARNING

The GFCI will not reduce the shock hazard if the short is between a neutral and hot wire or two hot load wires.

BrandMotion FreedomCharge MAX Qi Wireless Dash Charger (Model: FDMC-1312)

This article provides an overview of the BrandMotion Dash Wireless Charging Station (Models: FDMC-1312), which may be built-in to the dash or cockpit area.

Charging your phone has never been easier. FreedomCharge uses the wireless charging standard, Qi, to keep your phone going without the hassle of plugging it in. This type of charging has taken off with use in homes, but not until recently have you been able to get this convenient and easy to use technology in your vehicle. Some coaches may have more than one wireless charging station installed; however, the size and shape of the charging area may vary. Some chargers may be mat-style (flat on a driver or passenger side console), and some may be vertically installed as a bucket-style.

Operation

The wireless charging stations typically turn on at the same time as the battery disconnect. Dash-mounted chargers are powered from the fuse panel in the shore cord compartment (usually the USB F18 fuse). Some early production 2021 coaches may have used the Radio/AutoGenStart F13 fuse.

It works by using inductive charging technology to allow your smartphone to charge without connecting a charger. No longer will you have to search for your charger and orient it the correct way just to plug in your phone. Add a new level of convenience to your car and keep your eyes on the road, instead of fumbling with a tangled mess of cords. When a compatible device is placed on top of the charger, the audible tone sounds as the charger begins to charge phone, and the phone will also indicate it is charging. The updated triple coil allows charging through most thick cases, including Otterbox.



⚠ IMPORTANT

To find out if your cell phone is Qi compatible, refer to your phone's user guide or contact your network service provider.

Features

- Utilizes the wireless charging standard, Qi to charge your phones without cables
- Does not interfere with your vehicle's Bluetooth functionality while using your infotainment system.
- Charge's your phone to 100% battery and tapers off to avoid overcharging.
- Uses an initial audible tone to indicate charging when the phone starts charging.
- Easy cut-to-fit design converts most any vehicle phone storage tray into a seamless factory-look charging tray without unsightly cables.
- The non-slip charging mat holds your phone securely in place while driving.

Source(s): BrandMotion FDMC-1310 Landing Page
Product(s): BrandMotion Wireless Charging Unit (Model: FDMC-1312, Newmar Part Number: 153213)

USB Outlet, Auxiliary Input, and 12 Volt Receptacle Overview

This article provides a functional overview of the USB outlet, auxiliary input, and 12 volt receptacles in a coach.

USB Outlets

USB outlets may be located in various places throughout the coach. The number of ports may vary. The USB outlets are for charging only and are not connected to any entertainment equipment. They simply provide convenient accessory charging without filling your 120 volt outlets with chargers. Most USB outlets require 120 volt power when located outside of the cockpit area of the coach.

Auxiliary Inputs

USB ports labeled with auxiliary input are normally connected to the dash radio and allow input to the radio via USB and or 3.5 mm cable. Refer to the owner's guide for the radio for information about selecting auxiliary inputs.



USB Outlets Examples



Auxiliary Inputs Examples

12 Volt Receptacles

Your coach may be equipped with one or more 12 volt receptacles conveniently located in the dash area. These 12 volt receptacles allow you to plug in a variety of 12 volt DC accessories, including cell phone battery chargers, camera battery chargers, etc. These are fused at 20 amps.

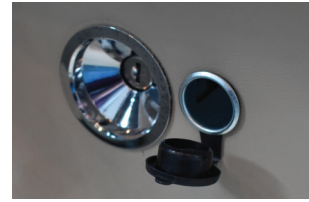

12 Volt Receptacle Example

Block Heater Outlet

Diesel coaches may have an outlet designed for use with the engine block heater. It may be located in the engine compartment or in one of the rear compartment bays.

This outlet may be controlled by the block heater button on coaches equipped with a SilverLeaf touchscreen. Coaches without SilverLeaf may have a switch in the overhead cabinet to turn the power to the outlet on or off, while others may be wired directly from the breaker box.

Coaches equipped with energy management systems operating on shore power of 30 amps or less may have power shed to the block heater if the other loads exceed the amperage set on the energy management system.

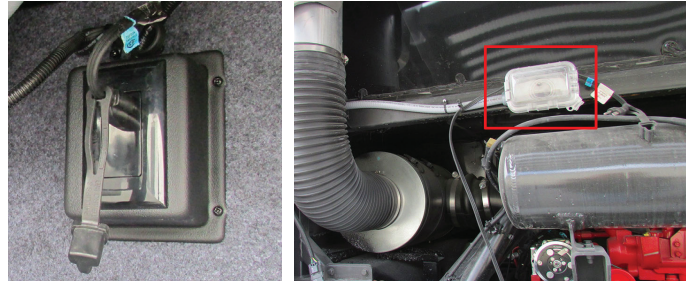

Solar Power

This article provides basic information about the solar panels that may be installed on the coach.

25 Watt Solar Panel Overview for Diesel Pusher Coaches

This article provides basic information about 25-watt solar panels that may be installed on diesel pusher coaches (beginning mid-model year 2022). If installed, this 25-watt solar panel will trickle charge the chassis batteries when exposed to sunlight.

The solar panel is protected by a fuse located near the solar panel, as well as a fuse normally located in the rear battery compartment on diesel pusher coaches (close to the chassis battery/batteries). The fuse is often marked with a label noting the solar panel.

The panel does not have an indicator or regulator since it is only a trickle charge and is not capable of producing enough voltage to damage batteries.

Larger solar panels (optional equipment on select coaches, such as option # L010) may also charge the house battery bank. For more information about larger solar panels, as well as the associated remote panel and controller, please refer to Newgle.

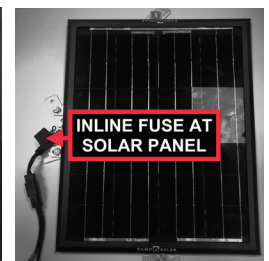
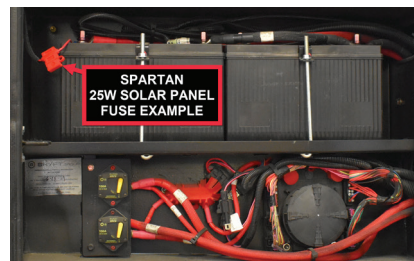

Xantrex C-Series Solar Charger Remote and Controller Operation (Model: C35, C40, C60)

This article provides basic operation instructions for a Xantrex C-Series Solar Charger Remote and Controller (Model: C35, C40, C60).

Remote Display (C40)

The Xantrex C-Series Meter Display provides a digital display of the voltage, current, and amp-hour status for the C-Series Multifunction DC Controller.

The C-Series Meters have three features:

- a Liquid Crystal Display (LCD) to show current, voltage, amperage, resettable amp hours and total amp hours,
- an Amp-hour Reset Button, which is also used to illuminate or dim the display, and
- a Light Emitting Diode (LED) to indicate system status.

NOTE FROM NEWMAR

Some charger remotes may not be labeled from the factory (left photo). Beginning mid-2022 model year, Newmar began installing a “Solar Panel Charger” label during the production process (right photo) to help coach owners understand what the remote panel controls.

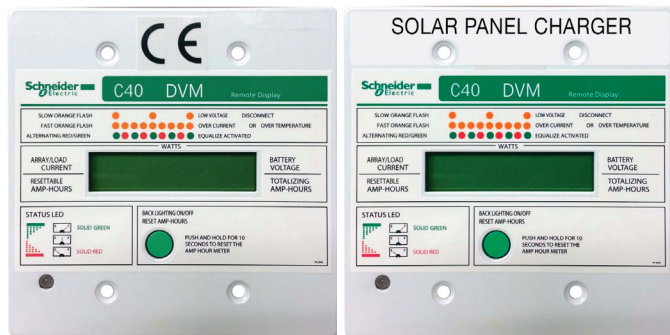

LIQUID CRYSTAL DISPLAY (LCD)

The LCD on the faceplate or remote provides the following information.

Information Type	Display Value / Range
Current from PV Array or DC Load	0 to 85 amps DC (in whole numbers only)
Battery Voltage	4 to 100 volts DC (in 0.2 volt increments)
Watts	0 to 3,600 watts (volts x amps)
Amp hours	0 to 65,536 Ah; can be reset to 0
Total amp hours	0 to 65,536 Ah; resets to zero when power is disconnected
Status LED	green, red, or orange

AMP-HOUR RESET AND BACKLIGHT BUTTON

The amp-hour meter on the faceplate or remote can be reset by two different methods.

Automatic resetting occurs when the C-Series Multifunction DC Controller is first connected and activated and each time it's disconnected from the battery or the meter cable.

To manually reset the amp-hour meter, press and hold the push-button on the front of the meter until the display resets.

This button also activates or deactivates the backlight for the LCD when pressed and released immediately.

LED STATUS INDICATOR

The multicolor LED indicates the operating status of the controller. A color-coded label is included on the cover of the controller explaining the status LED's indications. It blinks green, red, or orange depending on the status of the system. The sequence of the flash also changes depending on the operation of the controller at that time.

Controller (C60)

The C-Series controller (all models) has one multicolor LED status indicator and one reset button.

LED STATUS INDICATOR

The multicolor LED on the base unit, or the optional CM faceplate or CM/R remote, indicates the operating status of the controller. A color-coded label is included on the cover of the controller explaining the status LED's indications.

1. When in Charge Control mode, the LED will be green.
2. When in Load Control mode, the LED will be red.
3. When an Error Condition exists or the load has disconnected, the LED will be orange.
4. When battery equalization is in process, the LED alternates between red and green.

Multicolor LED indicator

STATUS

<ul style="list-style-type: none"> Green Blink Green Solid Red Blink Red Solid Orange Blink Slow Orange Blink Fast Red / Green Alternating - Equalization Enabled 	<ul style="list-style-type: none"> Charge Control Mode Battery Charged Load Control Mode Battery Discharged Load Disconnected Overload/Overtemp
--	---

3 STAGE PULSE WIDTH MODULATED CHARGE CONTROL

■ C35	35 Amp Controller	12/24	VDC
■ C40	40 Amp Controller	12/24/48	VDC
■ C60	60 Amp Controller	12/24	VDC

xantrex Charge / Load Controller

5916-190th STREET NE ARLINGTON WASHINGTON 98223 TELEPHONE(360)435-8826 FAX(360)435-2229



⚠ IMPORTANT

The green and red color of the LED only indicates the particular operating mode and the battery voltage level. It does not indicate whether the charging source is functioning properly.

RESET SWITCH

Use the Reset Switch on the side of the chassis for the following conditions.

- To manually initiate battery equalization in Charge Control mode, press and hold the Reset Switch until the red and green LED start to flash.
- To manually suspend battery equalization in Charge Control mode, press and hold the Reset Switch until the red and green LED stop flashing.
- To reset following an error condition, press and release the Reset Switch.
- To reset following a low-voltage disconnect, press and release the Reset Switch.

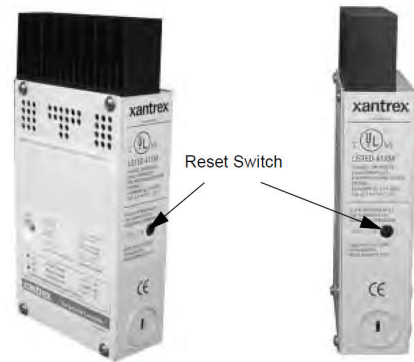

Source(s): C-Series Multifunction DC Controller Owner's Manual and C-Series Meter Display Installation Guide
 Product(s): Xantrex Solar Charger Remote (Model: C40R-100, Newmar Part Number: 122428) and Xantrex Solar Controller (Model: C60, Newmar Part Number: 122427)

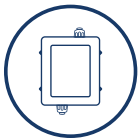

Transfer Switches and Surge Protectors

This article provides an overview of the transfer switch and the integrated surge protector.

The transfer switch allows your coach to be powered by more than one power source, while only allowing one active power source connection at a time. When the generator is turned on, this switch automatically transfers to generator power.

Surge protection was used on select coaches to protect the coach from power surges during storms and poor shore power conditions from the incoming shore power connection. Today, most transfer switches have integrated surge protection.

There will be a slight delay between the start of the generator and the electrical connection. This delay allows the generator to reach normal operating speed without needing to supply a required load. When the unit is plugged into shore power, an audible click will be heard in the transfer switch box. The sound is normal and indicates that the relay inside the transfer switch is engaging the outside power source.

WARNING

Due to the risk of electrical shock, service should be performed by a qualified electrician or authorized service technician. The electrical system may have multiple 120/240 volt power sources. All power sources must be turned off, and any auto generator start features must be disabled prior to servicing.

NOTE FROM NEWMAR

After market surge protection placed at the shore power supply source is an optional product, which provides an increased layer of surge protection. However, it is not required or installed by Newmar.

Product(s): This information is associated with more than one product. Refer to Newgle for more information about the product(s) offered for your coach's model year.

Southwire 50 Amp Automatic Transfer Switch (Model: 40450RVC)

This article provides basic operation instructions for a Southwire Surge Guard 50 Amp Automatic Transfer Switch (Model: 40450RVC).

NOTE FROM NEWMAR

These brief operation instructions are for quick reference only and should not take the place of the complete Operation Manual provided by this item's manufacturer. Refer to the corresponding product's links and files in Newgle for more details about your product.

The 40450 series automatic transfer switch (ATS) has many different protective features to protect your coach from low quality power. Included in these are protection against high voltage, low voltage, and an incorrectly connected chassis ground. If one of these fault conditions is encountered, the ATS will open both contactors in order to protect the coach. Once the fault condition goes away, the ATS will delay for approximately 2.5 minutes before trying to close the appropriate contactor again.

A remote power monitor may be installed in select coaches and allows for continuous visual indication of source voltage and load current or diagnostics.

If the ATS fails to close the contactor or transfer when expected, check the 40450 display to see if an error message is displayed. The screen will flash an error message for that failure such as "Loss of Ground", "High Volt", or "Reverse Polarity". The error condition must be corrected in order for the transfer switch to function correctly. Refer to the table on the following page for help in troubleshooting these conditions.

If there is no error message and the display instead reads "Delay Active" this means that the fault condition has cleared and that the switch is going through a 2.5 minute delay before it will attempt to close the contactor again. Wait until this delay is over to see if the ATS correctly closes its contactor.



If no display is available, check the level of the input voltage to ensure it is within the proper operating limits. Also check that the ATS is correctly connected to chassis ground and that the neutral conductor is correctly connected to ground at the power pedestal. Wait 2.5 minutes to check if the fault condition was temporary and has cleared. If so, the contactor will pull in at the end of the 2.5 minute period.

Test Procedure

1. Plug RV's shore power cord into utility power source.
2. Wait for the time delay, then observe remote display of shore power status.***
3. Turn on RV's generator (generator power source is dominant over shore power). A 30 second delay will occur.
4. Observe remote display for generator output status (Volts/Amps).
5. Switch off generator, observe remote display of transfer "Delay Active-Shore Power."
6. Shore power activated, observe remote display (Voltage/Amps). ***Acceptable shore and/or generator power range is 100-135 Volts. Load (Amperes) 0-50 Amps.

Note: During generator (only) power-up, the monitor display will be blank for approximately 30 seconds for generator warm-up.

Source(s): Southwire Surge Guard Installation and Operating Instructions Model 40450RVC/ Southwire Surge Guard Model 40450 RVC Troubleshooting Guide

Product(s): Southwire Surge Guard 50 Amp Automatic Transfer Switch (Model: 40450RVC, Newmar Part Number: 152216)

Surge Guard Automatic Transfer Switch Remote LCD Display Operation (Model: 40299)

This article provides basic operation instructions for a Surge Guard Automatic Transfer Switch Remote LCD Display (Model: 40299).

The optional Remote LCD Display is intended for use with Automatic Transfer Switch (ATS) unit 40350-RVC or 41390-RVC.

The Remote Power Control allows you to see detailed information such as voltages for Line 1 and Line 2, (typically 110-120VAC), current draws (0 to 50Amps), and status and conditions of the ATS, including time and date. Electrical faults, such as low voltage or an open ground connection, that cause the ATS to shut off power are shown on the remote display, allowing you to retrieve via the joystick a log of fault conditions kept by the ATS of electrical power at your location.

This is a helpful diagnostic tool that allows you to comprehend and correct problems with your RV's power. The display also features a right/left navigation lever allowing navigation through the various screens.

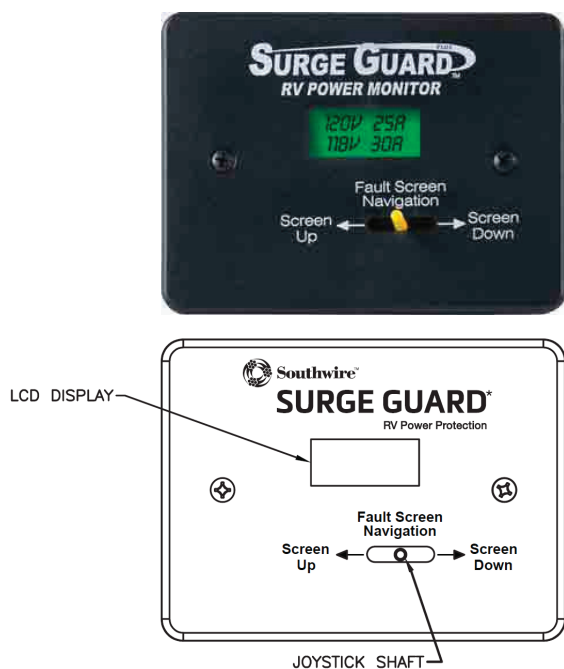

Features and Displayed Information

MAIN SCREEN

- Display of normal operating voltages and currents, for example 120V 25Amps for each Line (240V system). Shore power or generator power.
- Display of faulty power conditions responded to by ATS such as low voltages, high voltages, open ground, open neutral, reverse polarity, high frequency, etc.
- Display of delay condition when recovering from faulty conditions.

L1/L2 VOLT AND CURRENT SCREENS

Displays line 1/2 voltage or current. This is handy as it allows you to view the voltage or current when there is a fault condition being displayed on the main screen.

FAULTS SCREEN

Allows you to view a history of up to 50 faults which have been logged by the ATS. Each fault that has been logged contains the fault, the voltages and currents at the time of the fault, and the time and date when it occurred.

TIME/DATE SCREEN

Displays the current time and date and allows you to set the current time and date on the ATS unit.

JOYSTICK LEVER

To navigate through screens and set the time and date.

Operating Instructions

SCREEN NAVIGATION USING THE BUTTON/LEVER

There are several information screens associated with the Remote Display which can be selected via the lever on the front of the unit. Pushing the lever to the RIGHT repeatedly will access the screens in the following order. Pushing the lever to the LEFT accesses the screens in the reverse order.

When the VIEW FAULTS screen is displayed, momentarily pushing the lever in accesses a log of faults which have been stored by the ATS unit. Viewing the fault log data will be explained in more detail below.

DISPLAY FOR NORMAL OPERATION

During normal operation, the Remote Display screen reads the status of the RV electrical power, showing continuous voltages and currents for power lines 1 and 2 coming into the RV on the main screen. A secondary screen showing SHORE or GEN will momentarily display approximately every 8 seconds, indicating whether your RV is running on power for your shore connection or whether the ATS has transferred you over to generator power.

DISPLAY DURING FAULT CONDITIONS

If there are any faults or problems with your electrical power, the Remote Display will show the particular faults on the LCD screen with a 3 second interval between each item. The faults displayed can be any combination of the ATS fault codes.

DISPLAY DURING DELAY STATE

When the ATS is powered up, the Remote Display will display “Delay” and the elapsed time in seconds until it reaches 128 seconds. After the delay is completed, if shore power is good the ATS will connect power to the RV, and the unit will go to the normal operating screen showing voltages and currents as described above.

L1 VOLT | L2 VOLT SCREENS

These screens are useful for viewing the line voltages when the main screen is in delay or when L1 or L2 have a fault (line voltage that is too low or too high). The main screen will display line voltage between 102 and 132 volts; otherwise it will show that the line has a fault. The L1 VOLT and L2 VOLT screens however display a greater range, from 90 to 140 Volts. The L2 VOLT screen is only shown when using a 50 Amp ATS.

L1 CURR | L2 CURR

These screens are useful for viewing the line currents in amps when the Main Screen is in Delay or when it shows that L1 or L2 have a fault. The L2 CURR screen is only shown when using a 50 Amp ATS.

TIME/DATE SCREEN

View and/or set the current time and date on the ATS. To get to the TIME/DATE screen from the main screen, push the front lever right or left repeatedly until you see the time and date. To set, press the lever IN once quickly. You will see a blinking cursor. Push the lever left until the cursor is over the minutes digit.(Do not try to set the seconds - they reset to zero.) Once you have the correct setting for the minutes, continue on with setting the hour, date, month, year and so on by pushing the lever to the left.

Once you have entered the correct time and date, press and HOLD the lever IN for 3 seconds. You will see “TIME IS SET” once complete. You can now release the lever.

When you are on the TIME DATE screen and the cursor is not blinking, you can navigate to the other top level screens such as the main screen, or the L1 volts screen, etc.

VIEW FAULTS SCREEN

This allows you to view the faults recorded whenever the ATS detected a fault with electrical power. To view, momentarily push the front lever DOWN or IN. The screen will display fault 1, which is the most recent fault that occurred and was detected by the ATS. The screen will scroll through the following items for fault 1 every 3 seconds:

1. MODE- State of ATS when fault occurred (MODE SHORE = shore power; MODEGEN = transferring to Gen power, etc.)
2. FAULT CODE (L1 LO, L2 LO, etc.)
3. L1/L2 Volts and Currents at the time of the fault.
4. Frequency of Line 2
5. Time of Fault
6. Date of Fault

To see the next fault, push lever right, showing fault 2. Keep pushing the lever right to see up to 50 faults. Pushing the lever left goes backwards through the faults.

If no faults have occurred, you will still see fault number headings, but the information will be zeroed out. Voltages/ currents will be zero, time will be 00:00:00 and date will be 00-00-00; or you may have only 5 faults and the other 45 fault numbers will be zeroed out as described, etc.

To exit the fault screens, push the lever DOWN/IN momentarily, returning to VIEW FAULTS screen from which you can navigate as previously described.

L1 LO	Line 1 voltage is low (below 102 VAC)
L1 HI	Line 1 voltage is high (above 132 VAC)
L2 LO	Line 2 voltage is low (below 102 VAC)
L2 HI	Line 2 voltage is high (above 132 VAC)
REV POL	Reverse polarity condition (hot wire and neutral are swapped)
OPEN NEUTRAL	Neutral wire connection is missing or mis-wired
L1 OPEN	Line 1 connection missing or mis-wired
L2 OPEN	Line 2 connection missing or mis-wired
SHORE	RV connected to Shore Power
GEN	RV connected to Generator Power
DELAY	Delay mode waiting for power to come back on
SINGLPHA	Connection at 110V instead of 220V
POWER REM	Power has been removed due to fault
OPEN GND	Open ground fault condition (ground wire missing or miswired)
HI FREQ	AC line frequency high (more than 60Hz)
LO FREQ	AC line frequency low (less than 60Hz)

Source(s): Southwire Surge Guard Remote Power Control Monitor LCD Display with Navigation Installation and Operating Instructions

Product(s): This source is associated with more than one product. Refer to Newgle for more information about the product(s) offered for your coach's model year.



ELECTRONICS

This chapter provides operational instructions for the electronic systems installed in the coach, including camera and video, holding tank monitoring, multiplex systems, navigation, security and keyless entry, as well as WiFi.

⚠ NOTICE

NOTE: Audio-Visual (AV) equipment information is located in the Entertainment Systems category.

⚠ IMPORTANT

Any of the following quick start instructions provided by Newmar should not take the place of the manufacturer's complete documentation. Refer to Newgle for more information about electronics offered for your coach's model year.

Dash Infotainment Systems

Xite G4 Infotainment System with Dual 10.4” Touchscreens Operation (Model: XSG4NA-X4S)

This article provides basic operation instructions for a Xite G4 Infotainment System with Dual 10.4” Touchscreens (Model: XSG4NA-X4S).

Features

- Dual Touch Screens - Let your passenger program the day's route from their own in-dash LCD screen.
- RV GPS from NavNGo - Take control of your adventures using NavNGo navigation with online updates.
- House Mode - Control and listen to SiriusXM Satellite Radio from your outside entertainment area.
- HDMI - Connect compatible devices through HDMI and mirror to your G4.
- Media Center - Play back from your USB device or simply copy to the G4 on-board media center. Always have your music, movies and pictures with you.

This Quick Start Guide is intended to provide basic instructions to begin using your Infotainment Center. Failure to properly focus on the operation of your motor vehicle can result in death, serious injury and property damage. The Infotainment Center should never be used at a time or in a manner that distracts you from properly focusing on operation of the motor vehicle in which it is installed.

⚠ IMPORTANT

Please review all disclaimers, warnings and detailed operating instruction in your Xite Owner's Manual prior to using your Infotainment Center.

Main Touchscreen Monitor

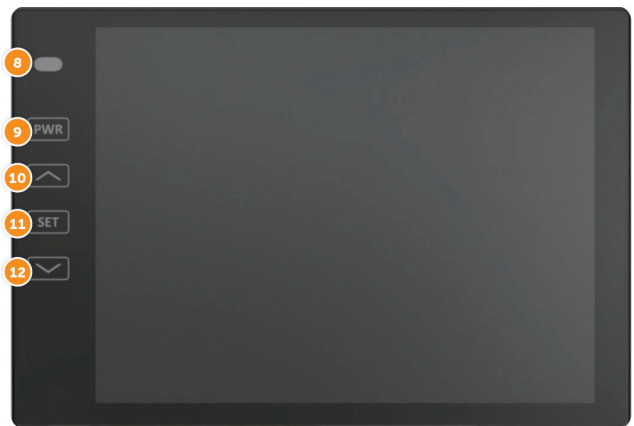
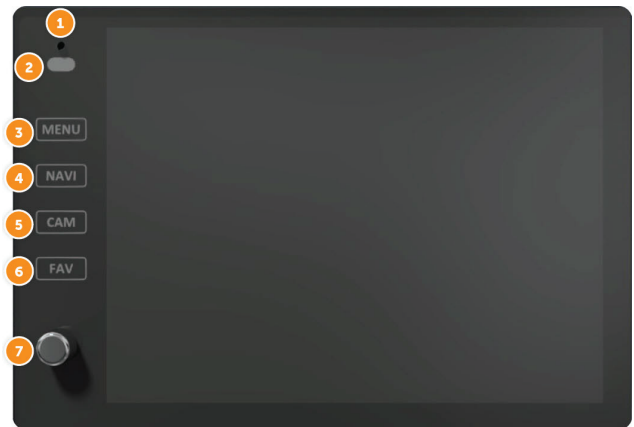

	Function	Description
1	Bluetooth Microphone	
2	LDR (Light Dependent Resistor) and IR (Infra-red Receiver)	<ul style="list-style-type: none"> LDR is used for the dimming of the display and is active when Auto dim in System Settings is set to Sensor. IR receiver is used with remote control operations.
3	Menu	<ul style="list-style-type: none"> Tap MENU button once to go to the Main Menu (or Home Page). When in the Main Menu, you can either use the touch screen to select the desired icon (source) or you can keep tapping the Menu button to select different icons on the screen. When icon is highlighted for more than 1 second, the system will automatically open that icon. You can also access the Main Menu from any screen by tapping the function icon in the top left corner of the current screen. Note: When viewing video in full screen, touch the screen once to bring up the icon header which will display the function icon. Tap the icon to return to the Main Menu.
4	Navi	<ul style="list-style-type: none"> Press the NAVI button once to go to the navigation system. While viewing the navigation press the NAVI button to return to the active source (Radio, or SXM, etc.). If the navigation route is running, navigation audio voice prompts will continue to be heard over the speakers according to the Navigation audio settings you have selected in the Settings menu. To hear only the navigation audio voice prompts, press and hold NAVI button for 2 (two) seconds. This will mute the active source until you leave the navigation screen.
5	Cam	<ul style="list-style-type: none"> Press CAM button to directly go to Camera Control page.
6	Fav	<ul style="list-style-type: none"> Your Infotainment Center is equipped with a favorite source hotkey. Press the FAV button once to directly access your favorite audio source. Favorite audio source is defaulted to Sirius XM, and it can be changed by going to Setup -> System -> Favorite Mode.
7	Volume/Power Rotary Button	<ul style="list-style-type: none"> Turn on the ignition to power up the Infotainment Center. When powered up, it will immediately go to the last mode (memory on playback) before it was turned off. In order to put the unit in standby mode, press and hold the rotary button once. During standby, your vehicles graphics together with date and time will be displayed. Press and hold the rotary button again to turn the unit on. Turn the rotary button left / right to adjust the volume to the desired level. A short press of the rotary button will Mute the audio. Note: When in standby mode, Infotainment Center consumes power. To completely turn the system on, remove the ignition key and / or ensure any auxiliary battery power to the system is turned off.
8	LDR (Light Dependent Resistor) and IR (Infra-red Receiver)	<ul style="list-style-type: none"> LDR is used for the dimming of the display and is active when Auto dim in System Settings is set to Sensor.
9	Power Button	<ul style="list-style-type: none"> Turns the Monitor On or Off.
10	Up Arrow	<ul style="list-style-type: none"> Adjust settings up.

11	Set Button	<ul style="list-style-type: none"> Press SET button to adjust screen display. Use this button in combination with arrow buttons. Available options are: Brightness (-10 to +10), Contrast (-10 to +10), Tint (-10 to +10), and Touch Adjustment for touchscreen calibration.
12	Down Arrow	<ul style="list-style-type: none"> Adjusts settings down.

7" Secondary (Passenger) Monitor

⚠ NOTICE

This monitor is an optional component and is not installed in all coaches with the XSG4 system.



	Function	Description
1	Status LED	<ul style="list-style-type: none"> No light means power to the monitor is off. Red Light indicates that unit is in sleep mode. Green Light indicates that unit is powered on and working.
2	PWR	<ul style="list-style-type: none"> If the status LED is red, press the PWR button once to turn the monitor on. If the status LED is green, press and hold PWR to turn the monitor off.
3	SRC	<ul style="list-style-type: none"> Press SRC button to change the video source displayed on monitor.
4	DIM	<ul style="list-style-type: none"> Press DIM to change the brightness of the screen (1 to 5). Set to SYNC for the brightness to be controlled by the Main Monitor.
5	NAVI	<ul style="list-style-type: none"> Press NAVI button to enter / exit Navigation Menu.
6	CAM	<ul style="list-style-type: none"> Press CAM button to directly go to camera view.
7	Up Arrow	<ul style="list-style-type: none"> Up and Down Arrows work in combination with SET button.
8	SET	<ul style="list-style-type: none"> Press SET button to adjust screen display. Use this button in combination with arrow buttons. Available options are: <ul style="list-style-type: none"> Brightness (-10 to +10) Contrast (-10 to +10) Tint (-10 to +10) Touch Adjustment for touchscreen calibration
9	Down Arrow	<ul style="list-style-type: none"> Up and Down Arrows work in combination with SET button.
10	IR Receiver	<ul style="list-style-type: none"> IR receiver is used with remote control operations (optional).

Main Menu



	Function	Description
1	Information Bar	<ul style="list-style-type: none"> The top area of the screen is the source information bar. It displays the current source together with temperature, compass, and time information as well as the Bluetooth connection status. Note: One needs to select a source to be able to see all the information mentioned above.
2	Main Menu	<ul style="list-style-type: none"> Infotainment Center is designed for simple maneuvering. The screen shown on the left is the MAIN MENU screen. From here, you can choose what source to access by tapping the appropriate icon on the touch screen. For more information on how to navigate through the Main Menu, please see the Function 3 in the page 5 of the Xite G4 D10 + A7 + SDHD CAM General Information & Setup Guide.
3	AUX Zone	<ul style="list-style-type: none"> Allows you to select what output is displayed on the Passenger monitor. This is the same as using the SRC button on that monitor.
4	House Mode	<ul style="list-style-type: none"> This option is only accessible when parking brake is engaged. When active, House Mode sends current source audio and/or video to other areas of the coach. <div style="border: 1px solid black; padding: 5px; margin: 5px 0;"> <p style="text-align: center; margin: 0;">NOTE FROM NEWMAR</p> <p>Newmar only sends current source audio (not video) to the exterior entertainment center.</p> </div> <ul style="list-style-type: none"> After 15 seconds of no input to the touch screen, the LCD displays will enter into sleep. Touch the screen to wake. House Mode is cancelled when selected again, park brake disengaged or power cycle is performed. Tap once to enter the House Mode. Tap once to exit the House Mode.

Settings

Access the Settings by selecting the Setup icon in the Main Menu. There are three Settings that can be changed and these are System, Video, and Audio. In addition, there are Settings for Radio, Sirius XM, Bluetooth and DVD, and to access these, you must go to the setup icon while one of these sources is active. To exit the Settings menu at any time, press the Settings icon in the top left of the screen.

SYSTEM SETUP

By touching the SYSTEM button, the settings for the system part of the Infotainment Center can be changed.

- Auto Dim
- Dim (Day Time)
- Dim (Night Time)
- Beep Tone
- Standby Screen
- Temperature
- Compass Display
- Time Set

- Favorite Mode
- Coach Warning
- Language
- Factory Set
- WiFi Settings

VIDEO SETUP

By touching the VIDEO button, the settings for the video part of the Infotainment Center can be changed.

- Brightness
- Contrast

AUDIO SETUP

- Treble Gain
- Mid Gain
- Bass Gain
- Equalizer
- Fader
- Balance
- Center/Woofers Volume
- Loudness
- NAV Volume: Sets the gain of navigation volume (-10 to +10). 0 is the center. This feature will help balance the navigation audio prompts with the system volume level according to the individual user preference.
- NAV Audio Mix: This option allows setting the way of navigation voice behavior in relation to the normal audio playback. The following options are available:
 - OFF: Navigation voice will not be audible.
 - MIX: Navigation voice will mix through normal audio.
 - FULL: Normal audio will be muted on the front speakers during navigation voice instructions.
 - Note: Navigation voice prompts can only be heard on front speakers.

For More Information

Refer to the G4 D10 + A7 + SDHD CAM General Information & Setup Guide for more information about your Radio Operation, Media Center, Bluetooth Operation, SiriusXM, iPod & iPhone AV Interface, HDMI, Split Screen, Camera, Navigation, House Mode, and Customer Feedback and Product Registration.

CONTACT XITESOLUTIONS NORTH AMERICA INC.

- Website: www.xsna.ca
- Email: support@xsna.ca

CONTACT RIVERPARK INC.

- Website: www.riverparkinc.com
- Email: navi@riverparkinc.com
- Toll Free: (800) 442-7717

Source(s): G4 D10 + A7 + SDHD CAM General Information & Setup Guide (Version 210427.01)

Product(s): This source is associated with more than one product. Refer to Newgle for more information about the product(s) offered for your coach's model year.

Apple CarPlay Operation via Xite Infotainment System

This article provides basic operation instructions for Apple CarPlay via the Xite Infotainment System. This applies to 9-inch and 10.4-inch touchscreens for Xite XSG4NA models beginning in 2023.

Apple CarPlay Operation

⚠ WARNING

Use of third party maps within CarPlay does not take into consideration your vehicle dimensions and restrictions. Use of these navigation systems is at your own risk.

Connecting your iPhone to CarPlay will allow you to get turn-by-turn directions, make phone calls, listen to music, check your calendar, and more—all from your vehicle’s display. Ensure that Siri is enabled on iPhone.

If Siri is not enabled on your iPhone, go to Settings > Siri & Search, then turn on one of the following:

- Press Side Button for Siri (on an iPhone with Face ID)
- Press Home for Siri (on other iPhone models)

Set up CarPlay by connecting your CarPlay Compatible iPhone to your vehicle using your vehicle’s USB port using an Apple-approved Lightning to USB cable.

The USB port is labeled with the CarPlay logo on the front of the core device.

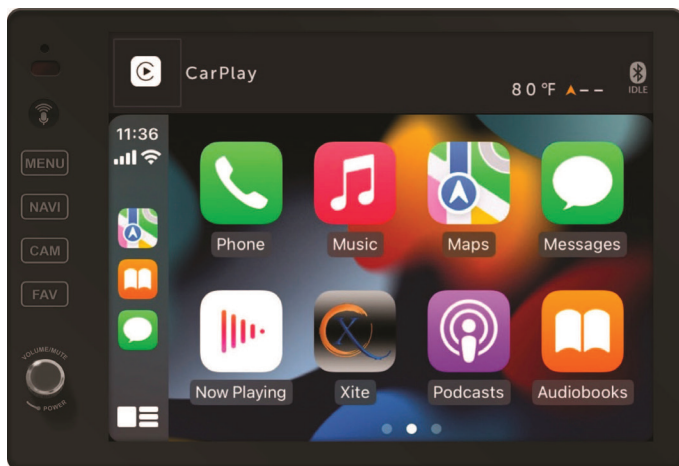

ASK SIRI ON CARPLAY

To activate Siri, do one of the following:

- Press the voice command button on the main display.
- Touch the CarPlay Home Button on the touch screen while displaying CarPlay.

When active the Siri icon will appear, as seen in the lower image.

Ask Siri a question or to do something, as you normally would on your iPhone.

Contents of the CarPlay menu will depend on which CarPlay enabled apps are installed on your iPhone.

To view the different apps, simply swipe left or right on the touch screen.

To return to general operation of the Xite device, press the Xite Logo on the main CarPlay screen, or by pressing the Menu button.

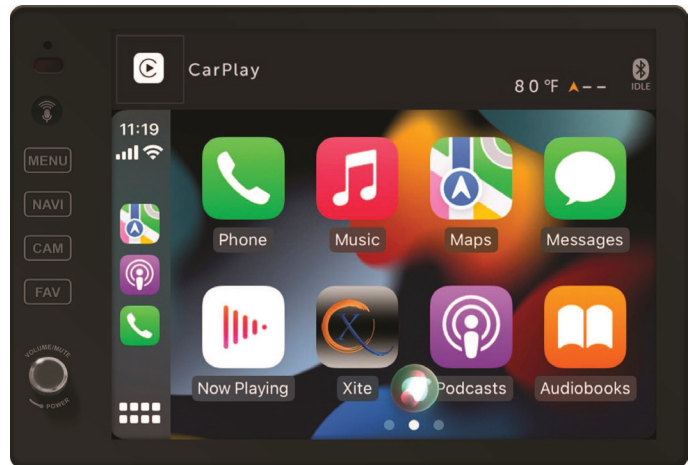

Source(s): CarPlay Setup & General Use Manual V220105.01
 Product(s): This source is associated with more than one product. Refer to Newgle for more information about the product(s) offered for your coach's model year.

Xite 7” Infotainment Passenger Monitor (Buddy Screen) Operation

This article provides a brief operational overview of the Xite Infotainment 7” passenger monitor (buddy screen).

The 7” auxiliary passenger monitor has the ability to mirror the main Xite screen or run separate navigation or camera screens.

Note: The driver can disable the navigation and mirror capabilities of the auxiliary monitor through the Aux Zone Settings from the main Xite screen; however the camera views are always available.



Cameras and Video Monitoring Systems

Camera and Video Monitoring System Overview

This article provides an overview of the camera and video monitoring system.

The video system features cameras mounted on the exterior of your coach and is connected to the in-dash video screen. This system comes on automatically when you put the transmission in reverse to allow you to see behind your unit when backing up. Additionally, it can be manually turned on in transit to allow you to monitor your towed vehicle or for additional assistance in passing maneuvers.

Rear View Cameras

Installed as a standard feature, the rear view monitor system assists the driver in the backing and parking of the vehicle. This system consists of a camera mounted on the rear cap and a monitor located on the dash.

Side View Cameras

As an option for the rear vision system, your unit may be equipped with “side view” cameras. These cameras are tied into the rear vision system and are activated by the turn signals. When a turn signal is activated, the monitor will switch to display that side of the unit. Once the turn signal cycle is complete, the display will revert back to the previous camera for the Voyager system and Xite system. In some Xite systems, the camera selection may default back to the rear camera.

HD360 Camera System Operation via Xite Infotainment System

This article provides basic operation instructions for the HD360 Camera System via Xite Infotainment System. The Xite HD360 cameras work in conjunction with a couple systems, including SilverLeaf and the chassis data (Spartan and Freightliner). These cameras are available as optional equipment on New Aire, Mountain Aire, London Aire, and Essex coaches. They are standard equipment on King Aire coaches.

Camera Selection

If the rear vision monitor is turned on manually, you can toggle through the cameras by using the “Source” button on the Voyager system, or the “Menu” button followed by the “Camera Select” icon on the Xite system, allowing you to stay on any given camera that you choose unless a reverse or turn signal is detected. Select Xite systems may have a “CAM” button that serves as a shortcut to the camera settings. Xite systems with a “360 Camera Select” switch allows the user to toggle through and select multiple camera views.

Camera Views of The HD360

	King Aire	Essex	London Aire	Mountain Aire	New Aire
Left Turn	✓	✓	✓	✓	✓
Right Turn	✓	✓	✓	✓	✓
Left Midship	✓	✓	✓	✓	✓
Right Midship	✓	✓	✓	✓	✓
Front	✓	✓	✓	✓	✓
Rear Normal	✓	✓	✓	✓	✓
Rear Horizon	✓	✓	✓	✓	✓
Rear Hitch	✓	✓	✓	✓	✓
Interior	✓				
Dual View	✓	✓	✓	✓	✓
Triview	✓	✓	✓	✓	✓
Quadview	✓	✓	✓	✓	✓
360 View	✓	✓	✓	✓	✓
Doorbell (2020 †)	✓				
Trailer 1	OPT	OPT	OPT	OPT	N/A
Trailer 2	OPT	OPT	OPT	OPT	N/A

Function of The Cameras

USING THE CAMERAS

To view the camera screen, touch the “MENU” button or the RADIO icon. Then, touch the “CAMERA CONTROL” icon.

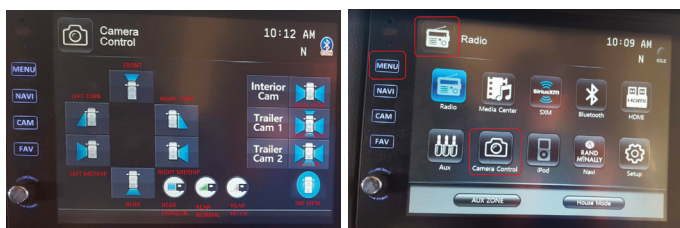

WHEN FIRST STARTING THE ENGINE

The camera monitor should display the REAR NORMAL view when first starting the engine.

DEFAULT CAMERA

If a camera button has been pressed, that view will become “DEFAULT.” If a trigger is activated (like a turn signal or reverse), the system will return to the “DEFAULT” camera view when that trigger is deactivated.

CAMERA PRIORITY

- Camera priority means that the system has certain views that will override other views.
- Pressing a manual button has priority over everything.
- If you are in reverse and decide you want to go to a different view, press a button and the view will change to the selected view. That view now becomes the “DEFAULT.”
- If a turn signal is active and the coach is put into reverse, the reverse command will override the turn signal command.

Standard Definition Vs. High Definition Cameras

The left turn, right turn, interior, trailer 1, and trailer 2 (if equipped) cameras are standard definition cameras. These are the only standard definition cameras in the system. The rest of the views are from the HD Xite side of the system.

Dynamic Parking Grid Lines (DPGL)

Dynamic Parking Grid Lines (DPGL) are moving lines that show you the APPROXIMATE path that the rear of the coach will take depending on the turn of the steering wheel. They use the information from the steering angle sensor from the chassis ABS ECU to calculate the trajectory of the turn.

1. The DPGL will only show up when the coach is in reverse.



2. The DPGL can be seen on two views: REAR NORMAL and 360 VIEW.

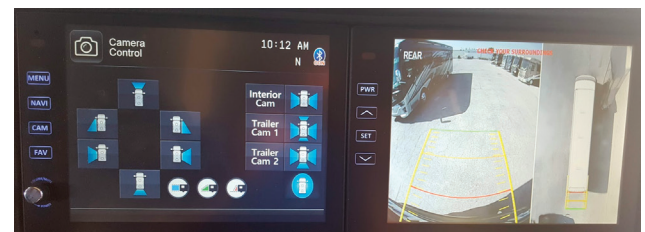

3. The DPGL can be tested by turning the wheel completely in both directions.

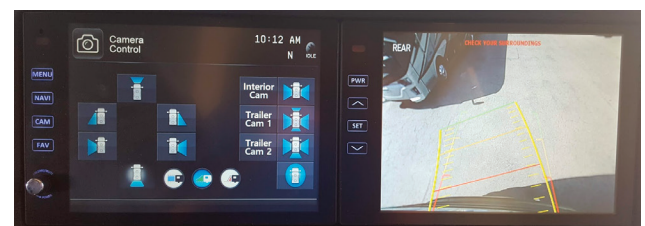

Static Parking Grid Lines (SPGL)

- In NADP, MADP, LADP and EXDP the SPGL are Standard equipment.
- SPGL DO NOT MOVE (Static) when the wheel turns.
- SPGL are only visible on the REAR NORMAL view of the camera screen.
- SPGL is an overlay controlled from a special rear camera.

Doorbell Camera Operation

The doorbell camera is only available in select coaches. There are a few ways to access the Doorbell picture:

1. On the Xite radio, press the “Entry Cam” button on the camera screen to view the picture on the camera monitor.
2. If the doorbell button on the grab handle is pressed, several things will happen:
 - All the displays (front overhead and bedroom SilverLeaf monitor, and dash camera monitor) will immediately switch to that camera, no matter what was showing on the screen at the time the button was pressed.

- A 60-second timer is activated. The screens will stay on the doorbell camera for one minute and then revert back to the camera view prior to doorbell activation. This time setting is configurable.
- Along with the camera switching when the doorbell is pressed, the patio light is also activated in case it is dark outside to allow you to see who is at the door. If activated by the doorbell, the light will turn off after 60 seconds.
- If the patio light was already on when the doorbell was pressed, it will remain on after 60 seconds.

When the coach is connected to the internet, MyRozie is capable of sending a text message to your phone that includes a still picture of the doorbell camera view.

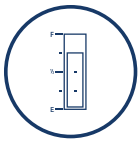

Holding Tank Monitoring Systems

The monitor panel allows you to check the approximate levels in the fresh, gray, and black water holding tanks, as well as propane levels (if equipped), and the battery condition. The monitor panel is generally located in the front overhead cabinet, or above or near the entrance door. An additional monitor panel may be located in the basement water compartment.

SilverLeaf Tank Monitoring System Operation via Touchscreen Display (Model: HMS404)

This article provides overview of the SilverLeaf Tank Monitoring System (HMS404) typically located in the water compartment. Starting with the 2022 model year, the SilverLeaf system includes an HMS404 panel installed in the water compartment instead of an SPX300 monitor.

⚠ NOTICE

This information is generic in nature and may not be specific to your exact coach model and/or year. Some features shown may not be available on all coach years, models, and/or floorplans.

Home Screen

From the home screen, the user can view and monitor the tank levels.

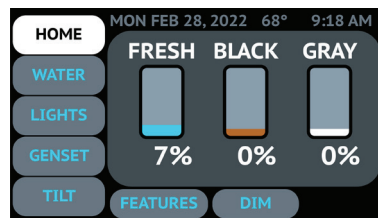

Water Screen

Press the Water button to view the Water page in order to turn the water pump or the auto fill function to ON, OFF, or TOP OFF. When turning on Auto Fill, the screen will flash “On+Ready.”

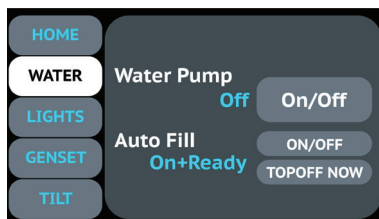

Lights

Press the Lights button (if equipped) to view the Lights page in order to turn the driver and passenger security lights ON and OFF.

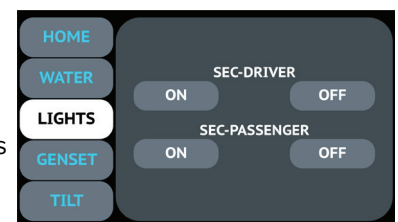

Genset

The Genset screen (if equipped) displays the current generator information, generator run hours, engine RPM, and engine temperature. Press the Genset button to manually start or stop the generator.



Tilt

Side Tilt Tank Dump Mode: This feature (when available) temporarily raises the passenger side air suspension so that the coach tilts to the

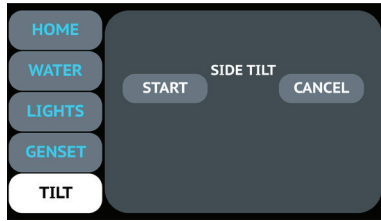

driver side to increase the holding tank slope angle to aid in dumping the holding tanks. This feature was first implemented during the 2023 model year on London Aire, Essex, and King Aire coaches.

For Tilt mode to work, the following conditions must be met:

- Park Brake engaged
- Vehicle ignition on
- Transmission in neutral
- Jacks retracted

If Tilt mode cannot be initiated for one of the reasons listed above, a message will be displayed on the GIC detailing the reason. Once Tilt mode is initiated, adjustments will be made by first lowering any corners that are above the Tilt height settings and then adding air to any corners that are below the Tilt height settings.

Adjustments will continue to be made until one of the following occurs:

- Tilt mode height settings are achieved
- Abort command received via RV-C network
- 10-second timeout on exhaust and 20-second timeout for air-fill

In each of the cases noted above, all adjustments will stop and remain static.

Tilt mode will be exited and the system will revert to standard operation when one of the following occurs:

- Park brake disengaged
- Vehicle turned off
- Transmission no longer in neutral
- Jacks extended
- Travel, leveling, or manual mode is selected via the GIC

Source of Tilt Parameters: Valid Document # VDC00948

Dim

Press the DIM button to increase or decrease the display brightness depending on the current brightness selection.

Features

Press the Features button to view a list of available features in the SilverLeaf system. For more in-depth information about each feature, refer to the operation and settings outlined in the SilverLeaf Touchscreen Guide specific for your coach model and year. This guide can be located in Newgle. Available features may include:

- Set the Clock
- Network Diagnostics
- Monitor Diagnostics
- Auto Fill Configuration
- Tank Configuration
- Customize Monitor
- Monitor Configuration
- View Clock
- Test Touchscreen
- Unlock the Settings with Code
- Reboot





Navigation System

Your coach may be equipped with a GPS based Navigation system. This system uses GPS technology to guide you through maps and information for traveling assistance. It features voice prompts and touchscreen technology to make scrolling through the menus and getting information incredibly easy.

WARNING

The navigation system is NOT intended to replace, supersede, or take precedence over any traffic signs, street signs, hazard signs, etc.

The navigation feature is intended to assist you with guidance to your destination. The system may need software and map updates. Updates are not warrantable issues, as roadways change over time and construction takes place, the maps and/or systems may become obsolete.

CAUTION

It is the driver's responsibility to make sure the roads are safe and appropriately navigated and roadway weight limits and clearances are rated for the vehicle you are driving.

NavNGo Navigation System Operation via Xite Infotainment System

This article provides basic operation instructions for the NavNGo Navigation System via Xite Infotainment System (Model: XSG4NA).

Getting Started

The XSG4NA range of infotainment systems come with an on-board Navigation program. This Navigation program is pre-loaded to the internal memory of the XSG4NA product. In order to provide the best possible user experience, the XSG4NA comes with a range of Connected Services to make the usage of the product as easy as possible.

NOTE FROM NEWMAR

To use any of the connected services, the user must have the Xite system connected to the internet via an active connection.

These Connected Services are:

ONLINE TRAFFIC

This feature will automatically download and analyze real-time traffic information and provide you with Route alternatives if you are already on the road and heading to a traffic event. Or the Online traffic will calculate around traffic when you start your new route.

ONLINE WEATHER

The Online weather service information can be used to view weather at your destination or along your current route.

ONLINE POI SEARCH

The Online POI search option is an extension of the pre-loaded database. The online POI's will provide you update to date Points of Interest with the latest available information.

OVER THE AIR UPDATES

Over the Air updates will allow you to update your maps, POI database and the Navigation program itself via an internet connection. You will be automatically notified when new updates are available and can download them when it is most convenient for you.

IMPORTANT

Map updates can be large (3GB+ of data), so it is advisable to perform these updates when connected to a Wi-Fi connection and not perform the update via a phone tether.

When you start using the product, you can download updates, at no cost, for the next 3 years.

Additionally, the XSG4NA is pre-loaded with the "Truck Attribute Map data". This additional map data contains additional road information in relation to road attributes. Items such as weight restrictions, bridge heights, limitation of the number of axles, tunnel restrictions, etc. This additional map data is of great relevance to RV owners to ensure that the roads suggested by the Navigation program are suitable for the specific RV.

▲ IMPORTANT

The suggested routes to your destination are only as good as the information provided to the program to calculate with. Make sure to set up the vehicle settings correctly and accurately to ensure that the routes suggested by the Navigation program are suitable for your vehicle. Failure to do so accurately may lead you down roads that are unsuitable for your vehicle resulting in damages to your vehicle, the roads, or violation of traffic laws.

Warnings and Safety Information

The navigation system helps you find your way to your destination based on GPS positioning. The XSG4NA does not transmit your GPS position; others cannot track you.

It is important to look at the display only when it is safe to do so. If you are the driver of the vehicle, it is recommended that you plan and review your route before you start your journey. Plan the route before your departure and stop if you need to change the route.

Always follow traffic rules at all times. If you deviate from the planned route, the program will recalculate and change the instructions accordingly.

INITIAL SET-UP

When using the navigation program for the first time, an initial set-up process starts automatically. This Initial setup is also repeated when the “Factory Reset” is done in the Navigation program setup menu.

1. Select your preferred language, then tap SELECT to confirm your selection. Later you can change it in Regional settings.
2. After accepting the End User License Agreement, the Configuration Wizard starts. Tap the NEXT button to continue.
3. Select the language and speaker used for voice guidance messages. You can also change it later in the “Regional settings”. Select your preference and tap NEXT to continue.
4. If needed, modify the time format and unit settings. You can also change it later in the “Regional settings”. Tap NEXT to continue.
5. In this step, you can adjust the routing preferences. Please take care to accurately insert all your vehicle parameters. The Navigation program will take this information into account to provide you with a route that avoids any roads that contain obstacles that should be avoided (low bridges, weight restrictions, etc.) If the information entered is incorrect, the program cannot take these vehicle-specific restrictions into account. You can also change it later in the “Route Preferences”. Tap NEXT to continue.
6. The initial set-up is now complete, tap Finish to enter the Navigation view.

SCREEN CONTROLS

The following sections describe the functionality and use of buttons, sliders, and other screen controls in the Navigation program.

USING BUTTONS AND OTHER CONTROLS

Type	Description	Function
Button	Opens a new screen where you can set a parameter.	Tap it once.
Button with Value	Displays the current value of a field or setting where the value can be changed. After the change, the new value is shown on the button.	Tap it once.
Icon	Provides additional information, for example traffic summary or itinerary.	Tap it once to open a screen with additional information or options.
List	Shows multiple options.	Grab the list anywhere and slide your finger up or down. Depending on the speed of sliding, the list scrolls fast or slow, only a bit or till the end. Alternatively, move between items in a list with the arrows and tap the value that you want to select.
Switch	Shows whether a feature is enabled when there are only two choices.	Tap it to turn the switch on or off.
Slider	When a feature can be set to different values in a range, the program shows an indicator on a gauge that displays and sets the value.	Drag the handle to move the slider to its new position. Tap the slider where you want the handle to appear.
Virtual Keyboard	Used to enter text and numbers.	Each key is a touch screen button.

The Navigation menu contain several menu items on one or more pages.

The UP ARROW button is always present in the top left corner of the screen. Pressing this button will bring you back to the Map view immediately regardless of where in the sub menu you are.

NAVIGATION VIEW

The navigation view is the main screen that shows the planned route on a map. The program works with digital maps which are not simply the computerized versions of traditional paper maps. Similar to paper road maps, the 2D mode of digital maps shows you streets and roads. Elevation is also illustrated in color.

The navigation view displays the following screen buttons, data fields, and route information on the map during navigation:

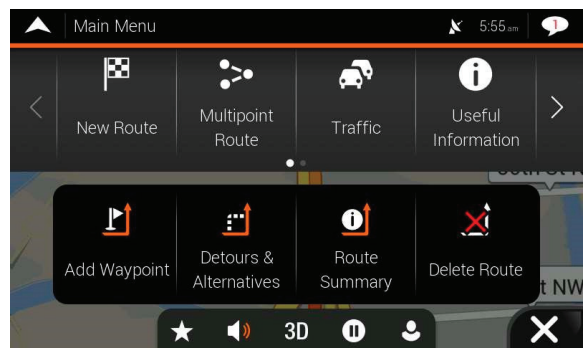

NOTICE

Some buttons, fields, or icons may not be available in your product version.

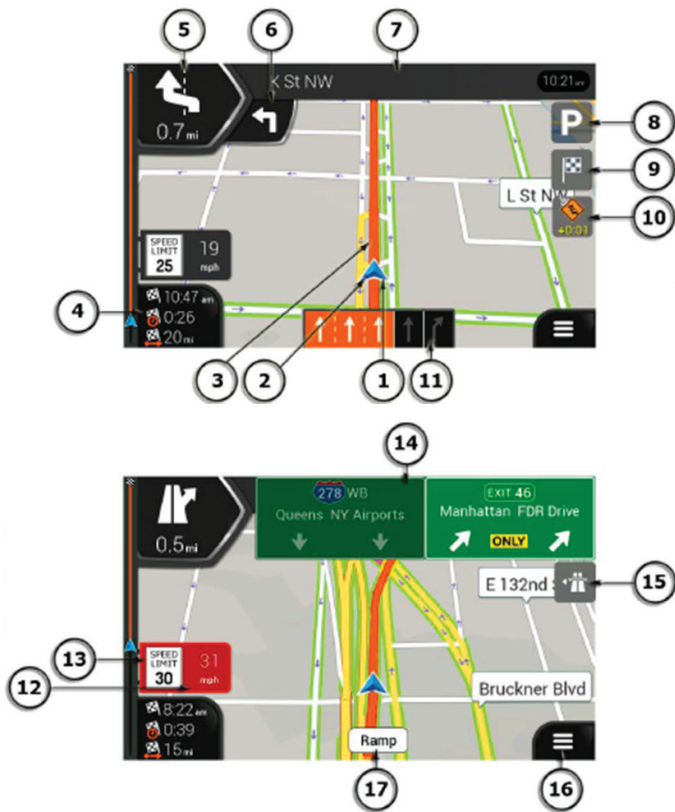

12	Alert Point Warning	It shows the type of the alert points when approaching a road safety camera or other Alert Points like school zones or railroad crossings. You must make sure that using this feature is legal in the country where you intend to use it.
13	Speed Limit Warning	It shows the current speed and the speed limit when speeding.
14	Signpost	It shows the available destinations and the road numbers.
15	Freeway Services	By tapping it, you can check the details of the next few service stations (gas stations, restaurants) when traveling on a freeway.
16	Navigation Menu	By tapping it, you can open the Navigation menu, where you can reach other parts of the program.
17	Street Name	It shows the current street name. By tapping it, you can open the Where Am I screen.

Settings Menu

You can configure the navigation settings, and modify the behavior of the program, by tapping the MENU button (3 horizontal lines), followed by the SETTINGS button.

NOTICE

Changing some of these settings may not have an effect in your current region if the map data do not contain the required information.

The Settings menu provides the following options:

BUTTON	FUNCTION
Route Preferences	Select the type of vehicle you are driving, the road types used in route planning, and the route planning method.
Sound	Adjust the different sound volumes.
Warnings	Enable and set up warnings for speed limit, Alert Points (such as speed cameras).
Navigation View	Fine-tune the appearance of the Navigation view or adjust how the program helps you navigate with different kinds of route-related information on the Navigation view.
Regional	Change the voice guidance language, set the time zone, the measurement units, the time and date formats, and customize the application for your local language.
Display	Enable or disable menu animations.
Traffic	Enable or disable traffic information and modify detour settings.
Weather	Enable the online weather forecast and the automatic download of weather information.
Online Services	Enable or disable services that require Internet connection.

Number	Name	Description
1	Current Position Marker	The current position is displayed as a blue arrow by default. When there is no GPS position, the current position marker is transparent and it shows your last known position.
2	GPS Position	The dot near the arrow shows the GPS position as perceived by the GPS receiver.
3	Planned Route	The planned route is displayed as an orange line.
4	Data Fields	Three data fields show the following information: <ul style="list-style-type: none"> The estimated time of the arrival at the destination. The remaining time of the trip. The remaining distance to the destination. You can change the default values in Settings or by tapping and holding the area where the data fields appear. If you have not selected a destination, you can see your heading instead of the three data fields.
5	Next Turn Preview	It shows the type of the next maneuver and its distance.
6	Second Next Turn Preview	It shows the type of the second next maneuver if it is near the first one.
7	Next Street	It displays the name of the next street. If you have not selected a route destination, you can see nearby house numbers, if they are available.
8	Parking Around Destination	It appears near the destination. By tapping it, you can check the available parking facilities around your destination.
9	Destination Menu	It appears near the destination. By tapping it, you can check the trip summary, find Places around your final destination, save the current location, or suspend the navigation.
10	Traffic	It shows traffic-related information.
11	Lane Information	On multi-lane roads, it shows the lanes ahead and their directions. The highlighted arrows represent the lanes and direction you need to take.

ROUTE PREFERENCES SETTINGS

The following settings determine how routes are calculated:

BUTTON	FUNCTION
Vehicle	Set the type of vehicle you want to use to navigate the route. Based on this setting, some of the road types can be excluded from the route, or some of the restrictions may not be taken into account in route calculation.
Route Planning Method	Optimize the route calculation for different situations and vehicle types by changing the planning method.
Navigation Mode (On-Road)	Select on-road or off-road navigation.
Road Types	Select your preferred road types for the route.

VEHICLE TYPE SELECTION

Press this option to open the vehicle type selection menu. The following options are available per default:

BUTTON	FUNCTION
Car	Maneuver restrictions and directional constraints are taken into account when planning a route. Roads are used only if access for cars is allowed. Private roads and resident-only roads are used only if they are inevitable to reach the destination. Walkways are excluded from routes.
Bus	Maneuver restrictions and one-way streets are taken into account when planning a route. Roads are used only if access for buses is allowed. Private roads, resident-only roads and walkways are excluded from routes.
Class A RV	The Class A RV vehicle profile is set with default values for a generic Class A RV. Maneuver restrictions and one-way streets are taken into account when planning a route. Private roads, resident-only roads and walkways are excluded from routes. If the map contains data on dimension, weight, number of axles they can also be taken into account when planning a route.
Class B RV	The Class B RV vehicle profile is set with default values for a generic Class B RV. Maneuver restrictions and one-way streets are taken into account when planning a route. Private roads, resident-only roads and walkways are excluded from routes. If the map contains data on dimension, weight and freight restrictions, they can also be taken into account when planning a route.
Class C RV	The Class C RV vehicle profile is set with default values for a generic Class C RV. Maneuver restrictions and one-way streets are taken into account. Roads are used only if access for buses is allowed. Private roads, resident-only roads and walkways are excluded from routes. If the map contains data on dimension, weight and freight restrictions, they can also be taken into account when planning a route.
Truck	Maneuver restrictions and one-way streets are taken into account when planning a route. Roads are used only if access for trucks is allowed. Private roads, resident-only roads and walkways are excluded from routes. U-turns are excluded from routes (turning back on a divided road is not considered as a U-turn). If the map contains data on dimension, weight and freight restrictions, they can also be taken into account when planning a route.
Add New Vehicle	With this option you can add your own vehicle profile.

MODIFYING VEHICLE PROFILES

In vehicle profile selection screen, press the UP ARROW and then the EDIT button to access the vehicle profile settings to adjust for your specific vehicle parameter. In Edit mode, you will see the symbol behind each vehicle type. Tap the symbol to access and select the details of the vehicle profile. Here the following basic options can be changed:

- Name (Allows you to rename the vehicle profile if desired)
- Vehicle type
- Maximum speed of the vehicle
- Fuel consumption in cities
- Fuel consumption on highways
- Engine type



Fuel consumption and engine type information is used to calculate and estimate amount of fuel needed as well as the approximate of CO2 produced. Also changeable for larger vehicle profile types are the “Extended Vehicle Settings.”

EXTENDED VEHICLE SETTINGS

The extended vehicle settings allow drivers to further specify their vehicle parameters to allow the program to offer the best available route for their vehicle type. Please make sure that all the specifics of your vehicle (height, weight, axles, etc.) are correctly entered into the vehicle profile settings. Incorrect settings will result in incorrect routes.

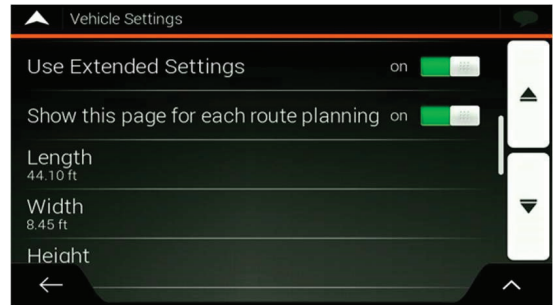

By default the option “Show this page for each route planning” is enabled. This option will prompt you to confirm that the vehicle profile specification is still accurate.

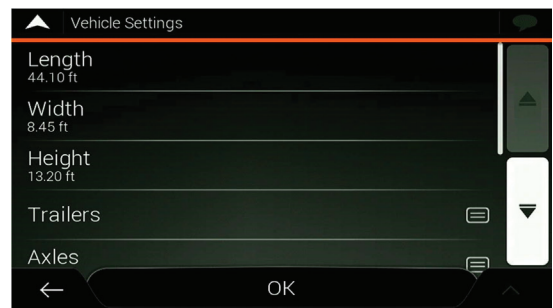

Warnings Settings

SPEED LIMIT

The program is able to warn you if you exceed the current speed limit. This information may not be available in your region, or may not be fully correct for all roads on the map. This setting lets you decide whether you wish to receive visible and/or audible warnings. The following warning types are available:

- Visual warning: the current speed limit is shown on the map when you exceed it.
- Audio and Visual warning: besides the current speed limit being shown on the map, you also receive a verbal warning when you exceed the speed limit with the set percentage.

If you prefer to see the speed limit sign on the map all the time (normally, it is shown only if you exceed the limit), you can set it here. You can also set the relative speed above which the application initiates the warning by adjusting a slider. The value can be different within and outside Cities.

DISABLING THE SPEED LIMIT WARNING

Issue: The speed limit warning is signaling even when the actual speed limit is kept.

Cause: The speed limit in the digital map data might differ from the actual speed limit of your current location.

Solution: Disable the speed warning by performing the following steps.

1. Tap the MENU button (3 horizontal lines).
2. Tap the SETTINGS button.
3. Tap the WARNINGS button.
4. Tap the Speed Limit button.
5. Tap the Warn When Speeding (Audio and Visual) button
6. Tap the Disabled option.

ALERT POINTS

Tap it to receive a warning when approaching a road safety camera or other Alert Points like school zones or railroad crossings. You must make sure that using this feature is legal in the country where you intend to use it. You can set the warning type for the different Alert Point categories (alert types) individually. The following warning types are available:

- Visual warning: the type of the Alert Point, its distance, and the related speed limit appear on the Navigation view while you are approaching one of these locations.
- Audio and Visual warning: besides the visual alert, beeps are played (when using a natural voice) or the type of the alert is announced (in case of a TTS voice) while you are approaching one of these points, and an extra alert warns you if you exceed the given speed limit while approaching.

For some of the Alert Points, the enforced or expected speed limit is available. For these points, the audio alert can be different if you are below or above the given speed limit.

- Only when speeding: The audio warning is only played when you exceed the given speed limit.
- When approaching: The audio warning is always played when approaching one of these Alert Points. In order to draw your attention, the audio alert is different when you exceed the speed limit.

Factory Reset or Reset All Settings

A factory reset can be done to restore all the factory default settings. The factory reset will also erase all user content (Search History, Routes, etc.).

1. Tap the MENU button (3 horizontal lines).
2. Tap the SETTINGS button.
3. Tap the UP ARROW to open the menu options.
4. Select either “Reset All Settings” or “Factory reset” to restore to the original default state. The application will prompt to confirm your selection. The application will restart to apply the changes.

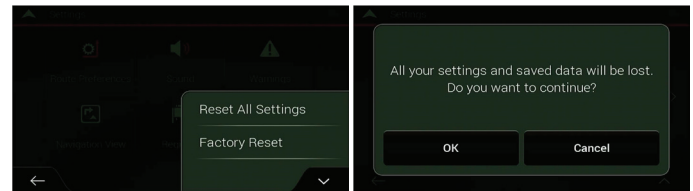

Updates

The XSG4NA is set up to only allow Over the Air updates. This means that the program will allow you to update new maps/POI databases or the program itself via an active internet connection.

When the program detects an active internet connection, it will automatically check whether updates are available for you to download.

UPDATES AVAILABILITY

There are 2 ways that the program will let you know an update is available.

- Via the message icon in the top right of the screen
- Press the MENU button (3 horizontal lines), followed by the SETTINGS button, and the SHOP button.

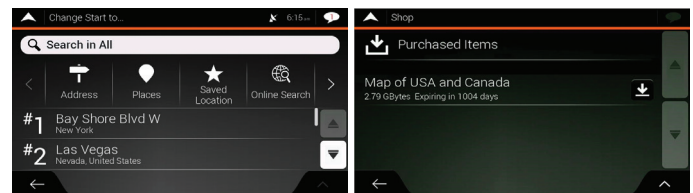

UPDATE INSTALLATION

If updates are available and you wish to install them, please make sure that you are connected to the correct WiFi Access point before starting up the update.

IMPORTANT

Updates can be very large and when connected over a cellular network via your phone, data transfer costs can occur. Do not switch off or restart the system during the download and installation of an update.

To start the update, press the DOWNLOAD button in the line of the update you wish to install. The update will start momentarily, and a status update will show the progress:

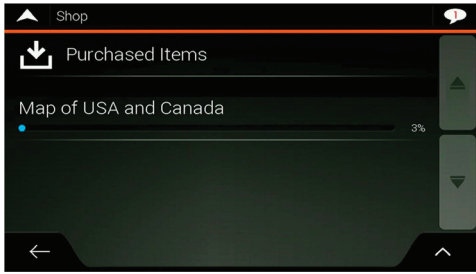

After the download and installation is completed, the program will prompt you to install the update:

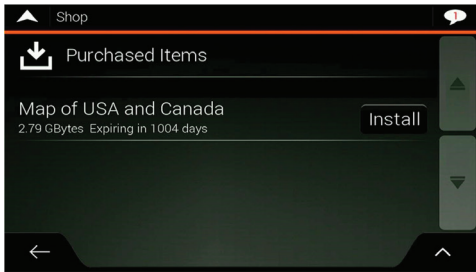

After the install, the program will prompt to restart and apply the updated portions:

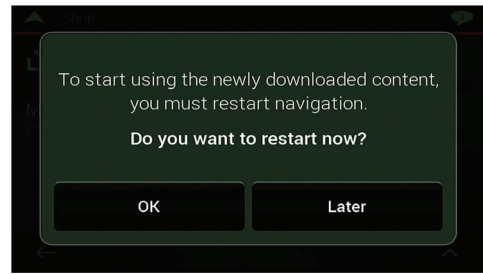

Select "OK" and the program will restart and is updated.

Source(s): Xite Solutions North America XSG4NA User Manual Version 032221.01
 Product(s): This source is associated with more than one product. Refer to Newgle for more information about the product(s) offered for your coach's model year.

How to Update Vehicle Profile Settings on an Xite G4 NavNGo Navigation System

This article provides a quick step-by-step guide on how to select the appropriate vehicle profile in the [Xite G4 NavNGo] Navigation software to ensure the correct routing.

- System: XSG4NA generation
- System OS: All
- Navigation: NNG

The first time the Navigation software is used, it will present a setup wizard to guide you through the basic settings:

Configuration Wizard

1. Select the appropriate language for the user interface. When the correct language is highlighted, press the "Select" button at the bottom of the page to continue to the next step.

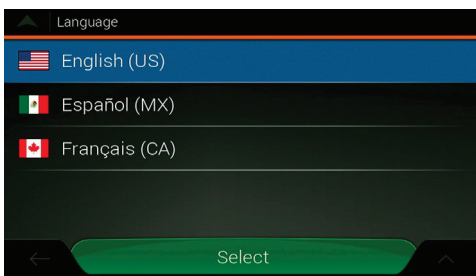

2. Accept the license agreement by pressing "Accept."

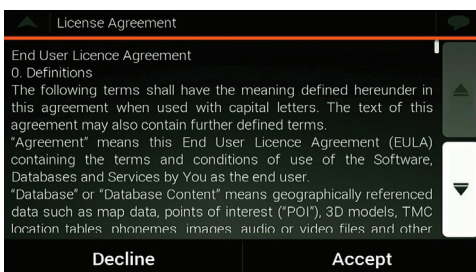

3. Proceed to the configuration wizard by pressing the "Next" button at the bottom of the page.

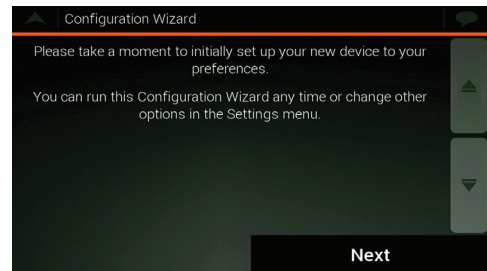

4. Select the desired voice profiles. When the selection is made and highlighted, press "Next." Note that during this step, the normal audio from the G4 will be suppressed.

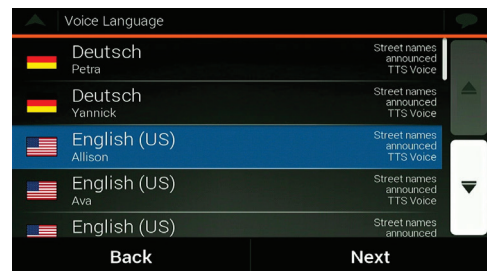

5. This page will allow you to change the units and formats used by the Navigation software to show you that information. By pressing the icon at the end of the line, you can change that specific setting.



6. In the route preferences, you can change the options for the actual routing. Make sure that the Vehicle profile line shows the RV class that the system is being used in. You can change that by pressing on that line in the page and select the required vehicle profile. When the correct vehicle profile is highlighted, press the “Back” button, and it will show your selection in the overview page of the Route preferences.

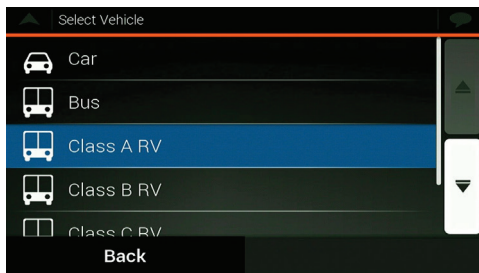
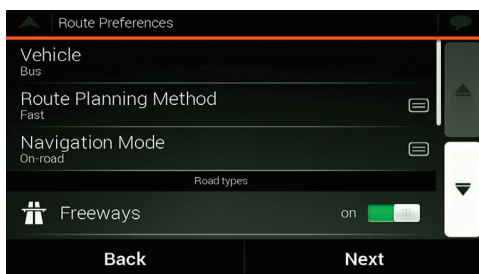

7. When completed, press the “Next” button to proceed.

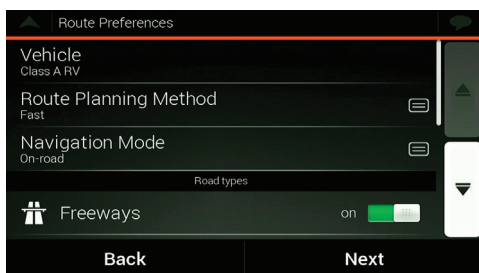

8. The configuration wizard is completed. Press the “Finish” button to complete the configuration and start the navigation program with your selected settings and options.

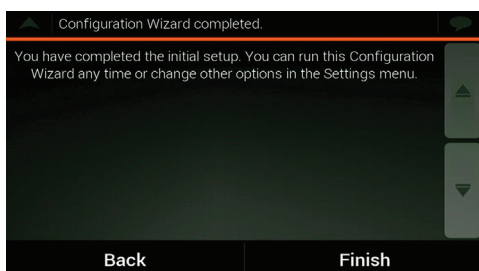

MANUAL CHANGES

Changes can be made later on as well, if needed, to update the routing preferences or the vehicle specific variables.

1. Open the main menu and select the “Settings” page. When in the settings page, select the “Route Preferences” option.

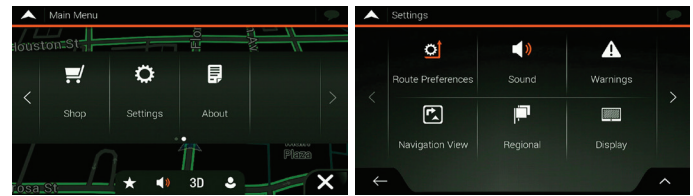

2. In the Route Preferences menu, you can select the Vehicle line to access the vehicle profile selections.

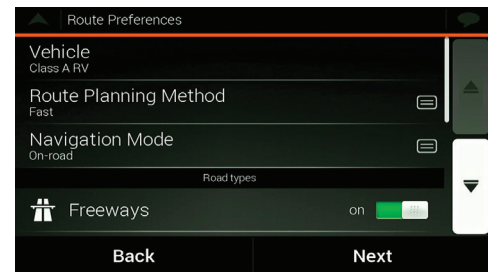

3. When in the vehicle selection list, press the Arrow up icon in the bottom right corner to access the “Edit” function.

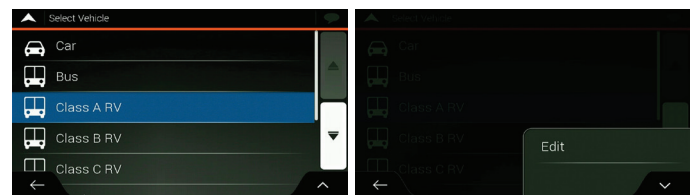

4. Select which vehicle profile you would like to edit by tapping the icon behind the vehicle profile name. and select the “Modify Vehicle” option to access the specifics of the selected vehicle profile.

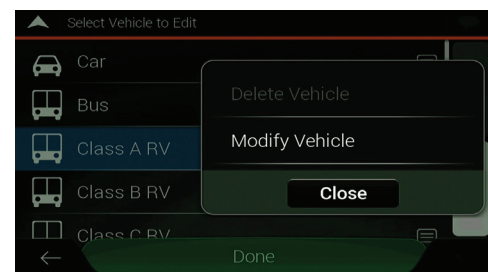

5. Change the vehicle profile variables you want to change here (length, weight, height, etc.). Scroll through the list to see all options.

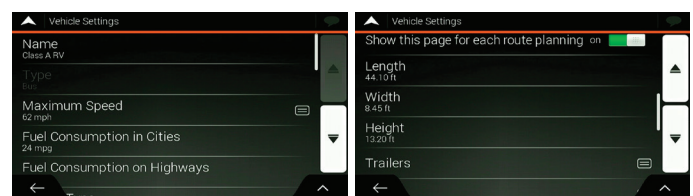

- When all the changes are completed, press the back arrow to return to the vehicle profile list, and press "Done" to finish the modifications to the vehicle profiles.

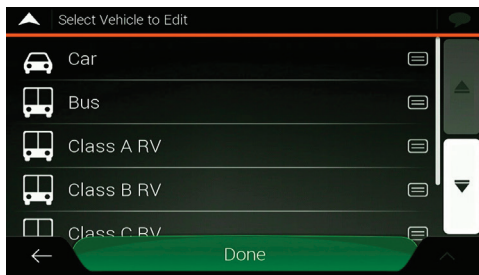

Source(s): Xite G4 Navigation Vehicle Profile Settings (April 2021)
 Product(s): This source is associated with more than one product. Refer to Newgle for more information about the product(s) offered for your coach's model year.

RV Toll Pass Transponder Overview

This article provides a basic overview and activation instructions for a Universal RV Toll Pass™ Transponder.

The revolutionary RV Toll Pass™ transponder now makes the open road even more open. The RV Toll Pass™ is a radio frequency multiprotocol toll transponder and single account solution that allows RVer's to seamlessly and conveniently travel the nation's toll roads by taking advantage of cashless electronic tolling.

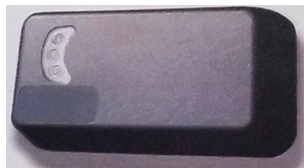

Owners of RVs and trailers can now access major toll roads across the United States (not available in Canada) with a single toll transponder. They can also easily manage all nationwide toll fees from a single account.



How Does It Work?

The RV Toll Pass transponder communicates with radio frequency antennas located at toll plazas and gantries, signaling that the vehicle is cleared to pass without having to stop to pay the toll. RV Toll Pass customers enjoy the freedom of all-electronic tolling paid through a single account for road usage across the U.S.

The RV Toll Pass is an interior-mounted transponder powered by a DC-to-DC converter, which is activated by ignition power. The transponder is securely attached to the vehicle windshield.

The RV Toll Pass transponder may be mounted on the interior windshield on Class A coaches and inside the front cap above the Newmar exterior badge on Super C coaches, with the longest side parallel to the bottom of the windshield.

⚠ IMPORTANT

Other tags must be kept at least 3 inches away from the transponder. The area on the dashboard beneath the transponder must be kept clear of paperwork and metallic items.

What Are The Advantages?

- Comes pre-installed in the vehicle
- RV Toll Pass covers the majority of toll roads in the U.S.
- One registration, one account, one transponder
- RV Toll Pass customers no longer need cash to pay toll collectors or stop at a toll booth to throw money into coin counter baskets.
- Eliminates the need for multiple toll transponders and accounts for use at separate toll authorities and regions.
- Tolls captured electronically are typically lower than the cash toll price, saving money.
- Many toll roads use technology that can capture the toll transaction of vehicles traveling at highway speeds, saving time and eliminating need to navigate those narrow lanes at toll booths.
- Nominal monthly fee charged ONLY in months tolls incurred.

How Do I Activate It?

Activation is the process of establishing an account and linking it to your RV Toll Pass transponder, vehicle and pre-payment method. Once activated, you will only be charged for replenishing your account when the balance drops below a minimum and you will only be charged a service fee plus tolls in months that you incur toll charges. You must have an active credit card and an established account to pay tolls charged to your RV Toll Pass™.

1. Go to <https://rvtollpass.com>, and visit the Login page to create an account.
2. Follow the instructions to register and activate your RV Toll Pass.
3. Your 13-digit RV Toll Pass ID (UID) will be provided in your new customer information package and is also printed on a sticker on the toll module, which may be upside down. You will also need your RV's license plate number(s), including any towed vehicle or trailer. Temporary plate numbers can be used and updated with permanent plate number(s).



⚠ CAUTION

Failure to register and activate your new transponder may result in toll violations and fines.

Can I Tow My Vehicle or Trailer?

Toll authorities that charge by number of axles typically utilize automatic axle counters to charge a toll based on the actual number of axles. Some toll authorities rely on a code programmed within the transponder to convey the toll rate category based on axles, tires and weight. Your RV Toll Pass transponder contains a code matching the toll rate category of your RV. If you are traveling with a towed vehicle or trailer, check with the Toll Authority and follow their guidance.

Where Does It Work?

The transponder works on virtually all U.S. toll roads that use interoperable electronic tolling technology. That is over 97% of major toll roads in the U.S. Toll roads with incompatible technology typically will charge tolls to your RV Toll Pass account based on the vehicle license plate. For more information about Non-Participating Roll Roads and Bridges, refer to the RV Toll Pass website .

Source: RV Toll Pass



Security and Keyless Entry Systems

Trimark Electronic Access Security Keyless-Entry Operation (e-FOB / e-PAD)

This article provides basic operation instructions for a Trimark Electronic Access Security Keyless Entry (e-FOB / e-PAD) system.

E-Pad Operation and Features

LOCK DOORS WITH KEYPAD

- Press and hold down the (1) button for 1-2 seconds. An access code is not needed to lock the doors.

DOOR BELL OPERATION

- The doorbell button provides a 0.5 second ground pulse from the 2nd Auxiliary output when pressed. An access code is not necessary for the doorbell.

USING SECURE OPERATIONS

- Entering a valid 5-digit access code provides a double beep and enables a secure operation. After entering an access code, the keypad is enabled for 5 seconds.
- The next button pressed initiates a secure operation, such as unlocking doors.



AVAILABLE SECURE OPERATIONS

Button (1): Unlock entry doors.

Button (2): Unlock doors wired to 2nd unlock output.

Button (3): NA

Button (4): Sequentially activate entry unlock and 2nd unlock outputs.

LIGHT ACTIVATION

When the alarm is armed, the parking lights and headlights flash. With an unlock instruction from either the fob transmitter or keypad; the dome light stays illuminated for 30 seconds and the parking and headlights flash.

Teaching Keypad New Authority/Access Codes

The Authority Code has only one purpose; it grants the owner the ability to set new Access Codes. The Authority Code must be EXACTLY 5 digits long. There are two ways to set the Authority Code with the TriMark Full Feature System. Changing the Authority Code erases all previous Access Codes and sets a new Access Code in memory bank 1 that is the same as the new Authority Code.

1. Press and release the push button 3 times. Wait 3 seconds. The keypad will beep for 3 seconds. The keypad is now in “Learn Mode”.

NOTE FROM NEWMAR

For Newmar’s location of the switch to reset and reprogram the Trimark Keyless Entry System, refer to the “Trimark Keyless Entry Reset/Program Switch” article in Newgle.

2. Enter a new 5-digit Authority Code. (Double chirps after each button press). The keypad chirps 3 times after the 5th digit’s entry.
3. Re-enter the new Authority Code for confirmation. The keypad will chirp FOUR times after successful confirmation. A long beep indicates a failure to change the code.
4. Test the new code to confirm it.
 - The user is given 2 minutes to complete this procedure. If it isn’t completed in time, or an error is made, the system will exit learn mode and a long chirp will sound to indicate the error.
 - While in “Learn Mode,” each button push provides a double-chirp and the backlight flashes.
 - The authority code is to be controlled by individuals (owners of vehicle, fleet manager, etc.) who manage the distribution of access codes to vehicle users.
 - The authority code should be changed when the vehicle is sold.
 - The authority code does not enable secure functions (lock/unlock doors, etc.) — it is only used to assign access codes.
 - Doorbell systems only allow codes using buttons 1-4 and provides for 4 unique access codes.
 - The keypad automatically leaves “Learn Mode” when the new code is set.

Assigning New Access Codes

The Access Codes are used for secure functions, such as unlocking doors. The Access Codes must be EXACTLY 5 digits long. With a valid Authority Code, an Access Code can be programmed with the following instructions:

1. Press the (3) button for 5 seconds until the keypad beeps. The backlighting of the keypad will flash indicating the keypad is in “Learn Mode.”
2. Enter the 5-digit Authority Code.
 - If you enter an INCORRECT Authority Code, the keypad will beep for 1 second, and leave “Learn Mode.”
 - If you enter a CORRECT Authority Code, the keypad will provide a constant beep that will only stop after you have defined a memory bank to store the new Access Code.
3. Press and release the button that corresponds to the memory bank. For example, press (1) button for Memory #1 and press (2) button for Memory #2. During this activity you are choosing 1 of 5 (4) memory banks.

4. Enter a new 5-digit Access Code. The keypad chirps 3 times after the 5th digit’s entry.
5. Re-enter the new Access Code for confirmation. The keypad will chirp 3 times after a successful confirmation. A long beep indicates a failure to change the code.
6. Test the new code to confirm a successful change. Repeat process to assign additional Access Codes.
 - Up to 5 (4 for doorbell keypads) different Access Codes can be assigned at any time. As additional Access Codes are defined, pre-existing Access Codes are overwritten. For example, if a new Access Code is assigned to Memory #3, the previous Access Code in Memory #3 is no longer valid.
 - If an error is made at any point, or if time runs out, the keypad will exit “Learn Mode,” provide a 1-2 second beep, and not change anything.

E-Fob Operation and Features - Cargo Mode



Button	Function
Entry Lock	Locks entry doors and arms security system
Entry Unlock	Unlocks entry doors and disarms security system. Also activates the porch light
Cargo Lock	Locks compartment doors and arms security system
Cargo Unlock	Unlocks compartment doors and disarms security system

While the engine is running, only the entry unlock function of the e-FOB remains activated — other functions are deactivated.

TEACHING ADDITIONAL FOB TRANSMITTERS

1. Turn ignition off and disarm alarm.
2. Press and release the programming button 3 times. The LED will turn on red after 3 seconds.

NOTE FROM NEWMAR

For Newmar’s location of the switch to reset and reprogram the Trimark Keyless Entry System, refer to the “Trimark Keyless Entry Reset Switch” article in Newgle.

3. Press and release the Lock button of each new FOB transmitter once. The LED will flash off and the horn will sound once. Up to 60 transmitters may be programmed at one time.

4. Repeat last step until all fobs are programmed.

Notes:

- If you place the system in learn mode and teach nothing, the system will exit in 10 seconds.
- When new transmitters are taught, all old transmitters are erased.
- The memory for codes will not be erased if power is removed.
- As soon as the LED turns off, the system is fully functional.

REPLACING THE KEY FOB BATTERY

To replace the key fob battery:

1. Remove screw on back of remote with a Phillips head screwdriver.
2. Pull/pry the housing apart.

3. Separate elastomer.

4. Push the battery out of the battery holder and replace it with a fresh one.

5. Reassemble fob.

The fob should not lose its programming after a battery change.

Keyless Ignition (Spartan Chassis)

For Spartan coaches equipped with keyless ignition and integrated key fob, refer to the “Spartan Keyless Ignition Quick Start Guide” in Newgle.

Source(s): TriMark e-ASK e-FOB e-PAD Consumer Manual

Product(s): This source is associated with more than one product. Refer to Newgle for more information about the product(s) offered for your coach's model year.

Coach Management/Multiplex Systems



KIB Multiplex Systems

KIB LCD Touchscreen Operation

This article provides brief operating instructions for a KIB LCD touchscreen.

Operation

Touch the inactive (blank) screen to activate and display the Lighting screen. Once the panel becomes inactive and times out, it will default back to the blank screen. Touch the Home icon to reveal the Home Menu page, which may include buttons for lighting, shades, fans, systems, or display brightness controls, as well as an icon in the upper right corner for More Information (i). Once a button is touched, it will turn red, indicating the circuit is active. The buttons are gray while the circuit is inactive.

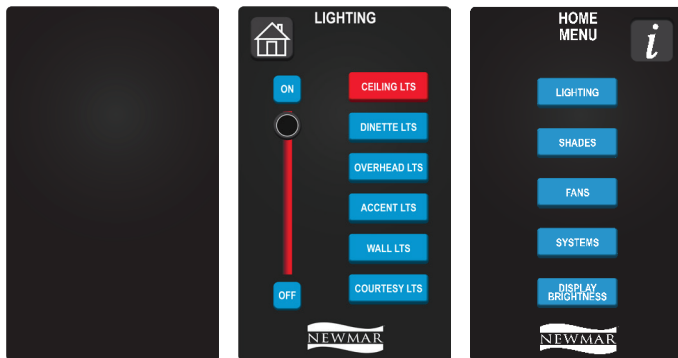

Lighting

Once a function is selected, such as Lighting, the screen will display additional buttons pertaining to the area in which the panel is mounted. The available buttons will vary by coach model and floorplan, as well as installed options. Potential buttons may include, but are not limited to:

- CEILING LTS
- BATHROOM LTS
- BEDROOM LTS
- WALL LTS
- MIRROR LTS
- VANITY LTS
- ACCENT LTS
- COURTESY LTS
- ALL LIGHTS ON
- ALL LIGHTS OFF



The All Lights On/Off buttons toggle all lights on and off in the coach at once.

Touch the ON button to turn on the selected light circuit. Touch the OFF button to turn off the selected circuit. On lighting circuits with dimming capability, drag the slider to adjust the brightness of the selected light circuit.

Shades

Touch the SHADES button, followed by the corresponding shade button to start and stop shade operation. Once a button is touched, it will turn red, indicating the circuit is in active operation. The buttons are gray while the circuit is inactive. The available buttons will vary by coach model and floorplan, as well as installed options. Potential buttons may include, but are not limited to:

- DOOR DAY SHADE
- DOOR NIGHT SHADE
- DINETTE DAY SHADE
- DINETTE NIGHT SHADE
- ALL DAY SHADES
- ALL NIGHT SHADES

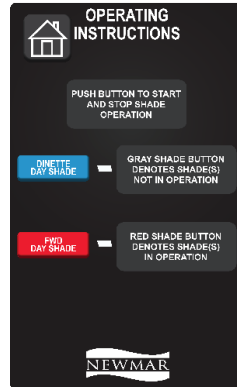

Fans

Touch the FANS button. Then select which fan you wish to operate. Once a button is touched, it will turn red, indicating the selected fan location. The buttons are gray while the circuit is inactive. The available buttons will vary by coach model and floorplan, as well as installed options, may include, but are not limited to:

- KITCHEN
- MASTER BATH
- STOOL ROOM



The fan operation screen provides buttons for On/Off, Rain Sensor Override, as well as the fan speed (High, Medium, or Low). A red button indicates the fan is currently in operation, which fan speed is selected, or the automatic rain sensing technology is disabled.

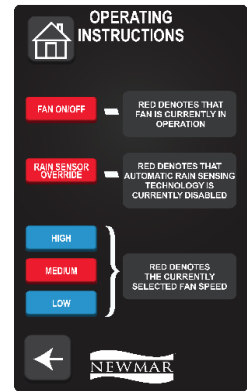

Systems

Touch the SYSTEMS button. Then select which system you wish to control. Once a button is touched, it will turn red, indicating the selected system is active. The buttons are gray while the system is inactive. The available buttons will vary by coach model and floorplan, as well as installed options, may include, but are not limited to:

- WATER PUMP
- HEATER (Turns the fan blower on and off)
- TV LIFT UP
- TV LIFT DOWN
- GENERATOR START/STOP
- AQUA MISER LT
- THEATRE MODE (Select coach models and years only)
 - This mode turns off all lights in kitchen and living room, lowers all living room and cockpit shades, turns on pre-programmed accent lights (may vary by floorplan), and raises the TV.
- AWNING (Select coach models and years only)
 - This window awning control allows users to extend and retract the window awnings.

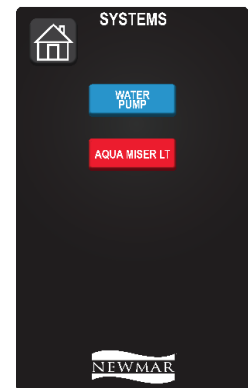
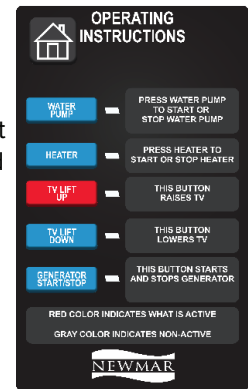

Silverleaf Coach Management System

SilverLeaf is a user interface that coordinates the various systems in Newmar high-end motor coaches. SilverLeaf is based on the RV-C industry standard for component communications. The SilverLeaf system is not the actual controller for the systems within a motor coach. It is simply the display that sends the signal to tell various components what actions to take. This interface allows the user to access the control functions for the various systems and make changes from one central location.

SilverLeaf Touchscreen 2023 Home Screen (Coaches without Lithium Ion Batteries)

The Home screen displays tank levels, basic electrical system information and provides access to all main functions controlled by SilverLeaf. These functions are accessible by tapping one of the buttons on the Home screen. Pressing the Home button from any of the display screens will return the user to the initial Home screen.

⚠ NOTICE

The buttons and settings on the screen will vary based on coach model, floorplan, and options. The following image is an example and may not reflect the graphics depicted on your screen.



Buttons

HOME

Pressing the Home button returns you to the Home screen. The Home button is only operational from other screens.

AC POWER

Pressing the AC Power button opens the AC Power screen, which displays the AC power source, line voltage, current (or amperage) usage, and AC line frequency (Hz). From this screen, you can access more information regarding Load Shed Setting and Load Status. You can also view the max charger draw and the status of the inverter(s) from the AC Power screen.

DC POWER

Pressing the DC Power button opens the DC Power screen, which displays the status of the DC inverters and provides access to the Inverter Settings screens. This button displays the batteries and their voltage, the status of the chargers/inverters and the rate of charge, as well as a Battery Disconnect status button that functions similarly as the rocker switch in the front overhead.

GENERATOR

Pressing the Generator button opens the Generator Control screen, which displays the generator operating status and Auto Generator Start (AGS) status. The Generator screen allows you to start and stop the generator and view the current generator operating status, including generator run hours, engine RPM, AC voltage, frequency (in Hertz), and engine temperature. This screen will also display AGS locks and triggers and allow the user to clear the locks.

WATER

Pressing the Water button opens the Water Control screen, which displays information about the auto fill function, water tank levels and water pump, and the LP tanks (if the coach is equipped).

CLIMATE

Pressing the Climate button opens the Climate Control screen, which displays and controls the settings for the HVAC system in the coach. This is where you can set the desired temperature for heating and cooling for individual rooms or for the entire coach, as well as schedule temperature changes by day, night, or when you are away.

BLOCK HEATER

Pressing the Block Heater button opens the block heater screen where the block heater can be turned ON or OFF.

FLOOR HEAT

The Floor Heat button is only available if the coach is equipped with floor heat. Pressing the Floor button opens the Floor Heat screen to display and control the settings for the floor heat function. The floor heat control system operates by switching the different floor zone heat mats ON and OFF, as determined by the intervals and values selected. There are three different zones in your coach, and each zone may be set for a different temperature.

TEMP (COACHES WITHOUT FLOOR HEAT)

The Temp button is only available if the coach is not equipped with floor heat. Pressing the Temp button opens the Temperature screen to display the outside ambient temperature. If the coach is equipped with optional floor heat, the button will read Floor Heat instead of Temp.

CAMERA

The camera button is available on the HMS707 displays in Essex and New Aire coaches with the 360 Camera option. The selectable cameras include:

- Rear exterior cameras
- Right side exterior cameras
- Left side exterior cameras
- Right and left mid-ship exterior cameras (mounted near the security lights)
- 360 view (possible with ignition power)

LIGHTS/SHADES

The Lights/Shades button will take you to the Shade and Light Control screen, where you can control the ceiling lights, shades, awnings, and the TV lift from the SilverLeaf screen. This button is only available on Essex and King Aire models..

DOOR LOCKS

The Door Locks button allows you to lock the entry door and the baggage door compartments.

CONFIG/SETTINGS ICON

Pressing the Config button or the Settings icon opens the Configurations screen, which provides access to numerous functional controls (when equipped), such as:

- Set the Clock
- Keypads
- Climate Options
- Generator Settings
- AutoGenStart Settings
- AutoFill Configuration
- Rozie Settings
- Tablet WiFi Settings
- System Component List
- Network Diagnostics
- Monitor Diagnostics
- Tank Configuration
- View AC Power History
- Customize Monitor
- Monitor Configuration

- Climate Screen Configuration
- View Logo
- View Clock
- Test Touchscreen

BRIGHT

This button controls the brightness of the screen. A dim bedroom display screen may be preferable at night so it does not inhibit sleep.

Status Displays

DATE | OUTSIDE TEMP | TIME

The system date, outside temperature, and time are displayed across the top of the screen.

TANK STATUS

The fresh, gray, and black holding tank statuses are displayed as percentage-full levels. These values are displayed as both a numerical percentage and bar graph.

DC HOUSE VOLTAGE /CHASSIS BATTERY CHARGE LEVELS

The house battery (house batt) and chassis battery (chassis batt) voltage values are displayed beneath the tank status.

CHARGE BRIDGE INDICATOR

The charge bridge function ties the house and chassis battery banks together. When the charge bridge is energized, “Bridged” will appear to the right side of the DC voltage values.

AC POWER VALUES

The AC power source (shore, generator), voltage, and current (amperage) for both AC power legs are displayed.

SilverLeaf Touchscreen 2023 Home Screen (Coaches with Lithium Ion Batteries)

The Home screen displays tank levels, basic electrical system information and provides access to all main functions controlled by SilverLeaf. These functions are accessible by tapping one of the buttons on the Home screen. Pressing the Home button from any of the display screens will return the user to the initial Home screen.

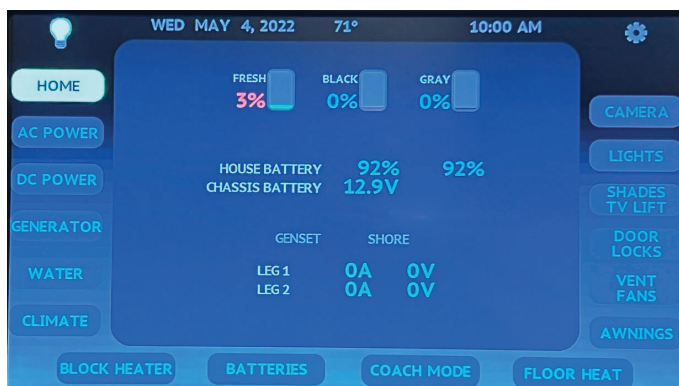

⚠ NOTICE

The buttons and settings on the screen will vary based on coach model, floorplan, and options. The following image is an example and may not reflect the graphics depicted on your screen.

Buttons

HOME

Pressing the Home button returns you to the Home screen. The Home button is only operational from other screens.

AC POWER

Pressing the AC Power button opens the AC Power screen, which displays the AC power source, line voltage, current (or amperage) usage, and AC line frequency (Hz). From this screen, you can access more information regarding Load Shed Setting and Load Status. You can also view the max charger draw and the status of the inverter(s) from the AC Power screen.

DC POWER

Pressing the DC Power button opens the DC Power screen, which displays the status of the DC inverters and provides access to the Inverter Settings screens. This button displays the batteries and their voltage, the status of the chargers/inverters and the rate of charge, as well as a Battery Disconnect status button that functions similarly as the rocker switch in the front overhead.

GENERATOR

Pressing the Generator button opens the Generator Control screen, which displays the generator operating status and Auto Generator Start (AGS) status. The Generator screen allows you to start and stop the generator and view the current generator operating status, including generator run hours, engine RPM, AC voltage, frequency (in Hertz), and engine temperature. This screen will also display AGS locks and triggers and allow user to clear locks.

WATER

Pressing the Water button opens the Water Control screen, which displays information about the auto fill function, water tank levels, and water pump.

CLIMATE

Pressing the Climate button opens the Climate Control screen, which displays and controls the settings for the HVAC system in the coach. This is where you can set the desired temperature for heating and cooling for individual rooms or for the entire coach, as well as schedule temperature changes by day, night, or when you are away.

BLOCK HEATER

Pressing the Block Heater button opens the block heater screen where the block heater can be turned ON or OFF.

BATTERIES

Pressing the Batteries button opens the Lithium Battery screen.

COACH MODE

Pressing the Coach Mode button provides a way for the user to select a usage method, allowing the SilverLeaf system to activate various settings based on whether the coach is being used, stored inside, or stored outside under various conditions.

FLOOR HEAT

Pressing the Floor Heat button opens the Floor Heat screen to display and control the settings for the floor heat function. The floor heat control system operates by switching the different floor zone heat mats ON and OFF, as determined by the intervals and values selected. There are three different zones in your coach, and each zone may be set for a different temperature.

CAMERA

The camera button is available on the HMS710 displays in King Aire coaches and HMS710 and or HMS707 on other coaches equipped with lithium batteries. The selectable cameras on King Aire include:

- Rear exterior cameras
- Right side exterior cameras
- Left side exterior cameras
- Right and left mid-ship exterior cameras (mounted near the security lights)
- 360 view (possible with ignition power)
- Interior camera mounted in the front overhead compartment
- Entry door camera

The selectable cameras on other SilverLeaf coaches (Essex, New Aire) may vary to include all or part of:

- Rear exterior cameras
- Right side exterior cameras
- Left side exterior cameras
- Right and left mid-ship exterior cameras (mounted near the security lights)
- 360 view (possible with ignition power)

LIGHTS/SHADES

The Lights Shades button will take you to the Shade and Light Control screen, where you can control the ceiling lights, shades, awnings, and the TV lift from the SilverLeaf screen. This button is only available on Essex and King Aire models.

DOOR LOCKS

The Door Locks button allows you to lock the entry door and the baggage door compartments. This feature is only available on select coaches.

LIGHT BULB ICON/BRIGHTNESS

This button controls the brightness of the SilverLeaf Touchscreen. A dim bedroom display screen may be preferable at night so it does not inhibit sleep.

Status Displays

DATE | OUTSIDE TEMP | TIME

The system date, outside temperature, and time are displayed across the top of the screen.

TANK STATUS

The fresh, gray, and black holding tank statuses are displayed as percentage-full levels. These values are displayed as both a numerical percentage and bar graph.

HOUSE/CHASSIS BATTERY CHARGE LEVELS

The house battery charge level percentages and chassis battery voltage values are displayed beneath the tank status.

CHARGE BRIDGE INDICATOR

The charge bridge function ties the house and chassis battery banks together. When the charge bridge is energized, “Bridged” will appear to the right side of the DC voltage values.

SilverLeaf LR125 Module with System Control App for Personal Devices Overview

This article provides quick start instructions for accessing the SilverLeaf LR125 “System Control” app and pairing it with the coach.

The System Control app allows the user to control numerous coach features directly from a personal device such as a smartphone or tablet. This relates only to coaches equipped with SilverLeaf and a LR125 module.

1. Download and install the System Control app from the app store on your Android or iOS mobile device(s).
 - The app may ask you for permissions. Accept these for full functioning of the app.
2. Make sure your mobile device is connected to your coach’s WiFi network.
 - Example: NewmarXXXX (XXXX = 4 digit number)
 - The network name can be found on the face of the WiFiRanger or Converge indoor router.
3. Start the System Control app from your mobile device.
4. The app will search and find the System Control module on its own. The app should start and load the User Interface.
5. If it does not connect, it will inform you that it has not found the module.
 - Check the connection to the coach network. You may be connected to another WiFi signal instead of your coach’s WiFi network or be out of range of your coach’s indoor router.

Source: LR125 SilverLeaf User’s Guide. For more information see the complete user guide provided by SilverLeaf, which can be found attached to the WiFi Server.

AC POWER VALUES

The AC power source (shore, generator), voltage, and current (amperage) for both AC power legs are displayed.



System Control

SilverLeaf Electronics Tools

Everyone

This app is compatible with all of your devices.

For customers with SilverLeaf touchscreen(s) with version 1.81 or higher, LR 125 version 2.01 or higher, web version 5.0, and operating system version 4.0:

An additional layer of SilverLeaf LR125/Control app security called “white listing” is available for the customer to use if they wish; however, it is not required. For more information about using white listing, refer to the PDF file in Newgle called “White Listing Devices via LR125 and System Control App.”

Source: SilverLeaf White Listing Devices via LR125 and System Control App. For more information see the complete user guide provided by SilverLeaf.



WiFi Systems

Due to the ever-growing demand of internet connectivity, a WiFi system in your coach can mean the difference between using costly mobile data and being able to access free WiFi wherever your travels may take you. Your coach may be equipped with one of the many options WiFi systems Newmar offers.

WiFi Ranger Converge LTE Indoor/Outdoor Router Operation

This article provides an operational overview of the WiFi Ranger Converge LTE Indoor/Outdoor Router (Model: Teton/Poplar Combo, Denali/Spruce Combo, and Aspen/Everest Combo). This information only applies to coaches equipped with an optional WiFi Ranger Converge Router.

Components

Get the most out of a WiFi Ranger system with an indoor & outdoor pack [...] for more network versatility and functionality when compared to a standalone unit. All of the long-range WiFi, LAN ports, USB tethering, and upgradability features unite in these Packs. Furthermore, you will enjoy maximum wireless coverage, performance, and reliability when using a Pack.

INDOOR ROUTERS

- **Poplar:** WiFiRanger Poplar is an entry-level mobile router with 2.4GHz WiFi, a USB port for LTE tethering, 100Mbps LAN ports, and an integrated LTE modem (optional).
- **Spruce:** WiFiRanger Spruce is a mid-performance mobile router with 2.4GHz / 5.8GHz WiFi, a USB port for LTE tethering, and 100Mbps LAN ports.
- **Aspen:** WiFiRanger Aspen is a high-performance indoor mobile router with Gigabit LAN, 2.4GHz / 5.8GHz WiFi, USB 3.0 LTE Tethering, and LTE Modem (optional).

INDOOR ROUTER UNIT (IDU)



Poplar

Spruce

Aspen

OUTDOOR ROUTER UNIT (ODU)



Teton

Denali

Everest

ODU comes in Black or White

OUTDOOR ROUTERS

- **Teton:** WiFiRanger Teton is an entry-level outdoor router with 2.4GHz WiFi, 1mi range, a 100Mbps LAN port, and an integrated LTE modem (optional).
- **Denali:** WiFiRanger Denali is a mid-performance outdoor router with 2.4GHz WiFi, 1.5mi range, a 100Mbps LAN port, and an integrated LTE modem (optional).
- **Everest:** WiFiRanger Everest is a high-performance outdoor mobile router with Gigabit LAN, 2mi Max Range, 2.4GHz / 5.8GHz WiFi, and LTE Modem(s) (optional).

Quick Start Guide

1. Power up your WiFi Ranger(s). Follow steps from Rooftop Installation and Interior Installation in order to power up unit(s), then wait 5 minutes.

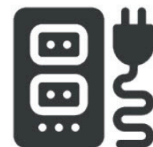

2. Wirelessly connect your device to your WiFi Ranger. Network names vary depending on which WiFi Ranger model(s) you have. Not that the blank space need to be filled in with the 4 unique digits of your WiFi Ranger(s).

- Pvt. WFR__Teton.___ _ _ _ _
- Pvt. WFR__Denali.___ _ _ _ _
- Pvt. WFR__Everest.___ _ _ _ _
- Pvt. WFR__Poplar.___ _ _ _ _
- Pvt. WFR__Spruce.___ _ _ _ _
- Pvt. WFR__Aspen.___ _ _ _ _

SMARTPHONE VIEW

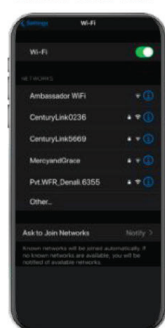

PC VIEW

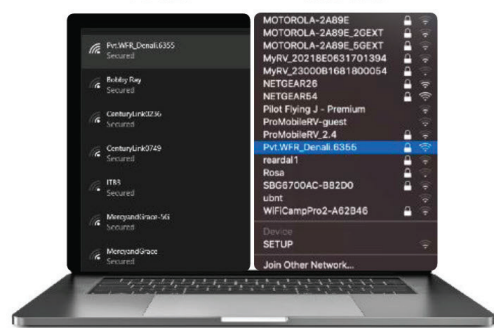

MAC VIEW

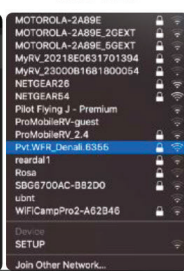

- Enter Password: changemenow_____. Enter password in lower case with no spaces. Note that the blank spaces need to be filled in with the 4 unique digits of your WiFiRanger(s).

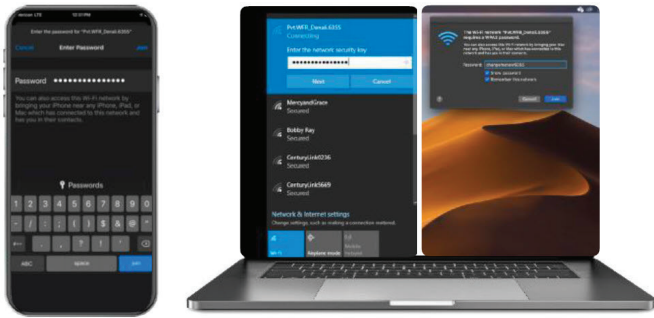

- Visit mywifiranger.com. This brings up the WiFiRanger Control Panel which can be bookmarked for future access.
- Click Connect on WiFi network or Cellular device. For filtered WiFi networks, proceed to the captive portal or login page and enter the necessary credentials or terms of service.

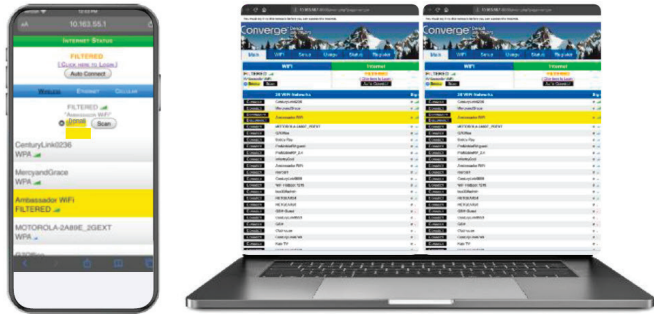

LTE Activation

WiFiRanger is pleased to provide LTE solutions that are not locked into a specific cellular carrier. This approach gives the customer increased flexibility over other competing offerings which are tied to singular carriers or data plans. The WiFiRanger LTE solution gives you the freedom to find the perfect plan for you. The cellular landscape is always evolving and advancing, so our goal is to assist you in making the most of the myriad of data options available. The following advice is to help you navigate the data plan and activation topics that are applicable to our LTE solutions. The LTE solutions offered by WiFiRanger are subject to change based on the evolving cellular landscape.

IMPORTANT CONSIDERATIONS

A. Data Plan Availability Varies by Region

- Some cellular carriers offer certain data plans by region. As such, you may find that the data plan that you desire is available through a cellular reseller or representative in another area while your local representative has more limited options. Check around or call a representative in another region if you can't find what you want locally.

B. SIM Card Type May Affect Data Plan Options

- WiFiRanger provides standard consumer SIM cards with their LTE modems. These SIM cards may not work on business data plans, but should support most consumer data plans. It is important to ask your cellular carrier if the SIM card you provide them is the right kind to meet your data needs.

C. Ease of Modem Activation Varies by Reseller / Carrier

- In some cases, it can be difficult to activate the WiFiRanger LTE modem and SIM card depending on the representative you speak with. Some representatives work for a cellular reseller that does not have the offerings you desire, or you may need a more knowledgeable representative to handle your request. Ask different cellular stores, resellers, or a direct Carrier representative until you find the right person to activate your modem and SIM card on the desired plan.

D. Data Plan Pricing Depends on Your Cellular Account

- In large part, the price of data plans for the WiFiRanger LTE modem are affected by your cellular account type and other data plan(s) on your account. In some cases, the WiFiRanger LTE modem will require having a data-only plan that is separate from the data plan attached to your smartphones or other devices. Checking with your carrier on costs will help you to understand how the carrier will handle the WiFiRanger LTE modem pricing and data amounts available.

E. Upgrading from Non-LTE WiFiRanger to LTE Modem May Require Additional Steps

- If you are upgrading a from a non-LTE WiFiRanger router to an embedded LTE modem, please be sure to click Check for Updates on the WiFiRanger Control Panel after installing the modem or upgrade kit. If you are experiencing problems or have questions about the new LTE modem, contact WiFiRanger to assist in getting your WiFiRanger configured to support the new modem. Our contact info is listed on the bottom of this guide.

F. Changing Cellular Carriers Should Only be Done After Verifying Supported Bands

- If you plan on changing cellular carriers, ensure that your modem supports the necessary bands. Supported bands listed below:

Bands	Category 4 Modem	Category 6 Modem
	Quectel EC25-AF	Quectel EP06-A
	2/4/5/12/13/14/66/71	2/4/5/7/12/13/25/26/29/30/66

Identify modem model on Setup tab of Control Panel under Cellular settings.

ACTIVATION CONTACT INFORMATION

CARRIER	CONSUMER PHONE	BUSINESS PHONE	WEBSITE
AT&T	888.333.6651	888.444.4410	att.wifiranger.com
VERIZON	**Official Support Coming Soon (we cannot guarantee Verizon data plans at this time)**		
MILLENICOM	800.996.1285	800.996.1285	millenicom.wifiranger.com

LTE Setup

ACCESSING CELLULAR SETTINGS

1. Power up the WiFiRanger system with embedded LTE modem(s).
2. Connect over ethernet or wirelessly to the WiFiRanger's network.
3. Access Control Panel of the WiFiRanger and select the "Setup" tab.
4. Expand modem settings by clicking the appropriate gear icon:
 - Standalone WiFiRanger (indoor or outdoor unit):
 - Click "Cellular" gear icon.
 - Pack WiFiRangers (indoor and outdoor units):
 - Click "Cellular" gear icon to access indoor unit modem.
 - Click "WFRControl" gear icon to access outdoor unit modem.

VIEWING SIM & IMEI NUMBERS

If you need the SIM or IMEI numbers for Cellular plan activation or support, then follow the steps below:

1. Follow steps for "Accessing Cellular Settings."
2. View SIM & IMEI numbers after expanding the modem settings.

Converge Routers & Modems Only Support Standard SIM Size. Be sure that SIM card is Standard size as Nano and Micro sizes will not fit properly within Converge routers or LTE modems. A SIM card size adapter kit may be used to resize the SIM.

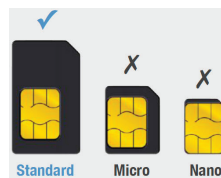

REFRESHING SIM NUMBER

If you've changed the SIM card in your WiFiRanger modem and need to refresh the SIM number, follow the steps below:

1. Follow steps for "Accessing Cellular Settings."
2. Click on "Clear SIM Details" then wait 30 seconds.
3. Click on "Reboot Cellular" then wait 60 seconds.
4. Reload the Control Panel and verify the new SIM number appears.

MANUALLY SETTING AN APN

(This is usually unnecessary on latest firmware since APN is automatically detected.) If you are unable to connect to the internet using the WiFiRanger modem even though your data plan is active, then there may be an issue with the modem's APN. An APN is a password used by the modem for authenticating with your cellular Carrier. To change the APN, follow the steps below:

1. Follow steps for "Accessing Cellular Settings."
2. Enter correct APN into the APN field:
 - Default APN shown in this table (most common)

Carrier	Default APN
Verizon	vzwinternet
AT&T	broadband
T-Mobile / Millenicom	fast.t-mobile.com
 - Unique APN on your Cellular account (only if applicable)
3. Click "Save Changes."

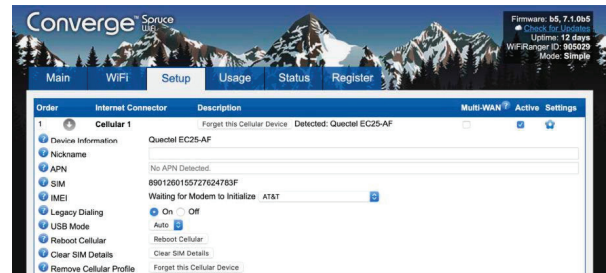

Source(s): WiFi Ranger Converge Indoor/Outdoor Routers Owners Manual (2020)
 Product(s): This source is associated with more than one product. Refer to Newgle for more information about the product(s) offered for your coach's model year.

Coach WiFi Security Alert - Changing Your Newmar Network Password(s)

Newmar Corporation has determined that the potential exists for unauthorized persons to gain unauthorized access to certain WiFi-connected components on some Newmar products via factory-installed WiFi routers which utilize factory password settings. The factory password setting is unique to each coach and there are no known instances of any such unauthorized access having ever occurred on any Newmar product. However, if an unauthorized person were to gain access to the factory-installed WiFi system there is a potential on some products for the unauthorized person to gain access to the WiFi-connected systems in the coach including certain televisions, sound equipment, cameras, and some coach management systems.

In order to protect against the potential for such unauthorized access to occur on Newmar products, Newmar Corporation highly recommends that customers owning the subject coaches change the factory password settings on the WiFi router to new passwords that have been chosen by the customer by following the directions provided below. Changing the factory passwords on the WiFi router will eliminate the potential for unauthorized persons to gain access to Newmar products via the factory password settings.

Note that changing the factory passwords to new passwords selected by the customer will cause a loss of pairing or connectivity between existing WiFi devices in the coach and the WiFi router. It will then be necessary to update the passwords on each of the individual WiFi-connected devices in the coach to have the same new password as the router in order to re-establish the pairing and connectivity between each of those WiFi devices and the router.

Please refer to the manufacturer's operation manual for pairing instructions for each WiFi-enabled component.

If the passwords are not updated on the WiFi devices in the coach after the WiFi router password has been changed, the devices will still function on their individual remote controls and on their individual in-coach control panels but those devices will no longer have any internet functionality or remote connectivity functionality until their passwords are updated to match the new WiFi router password.

If a customer is not able to make the recommended password changes to the factory-installed WiFi router immediately, the potential for unauthorized users to gain access to the coach WiFi systems can be easily blocked by simply turning off or unplugging the WiFi router until such time as the passwords can be reset.

Overview

Your Newmar coach's WiFi router has been preset to a unique factory password in order to ensure that all coach WiFi-enabled components were properly tested during the production process.

To better secure this network once you become the owner of the coach, it is highly recommended that you read and perform the following instructions for "Changing the Coach WiFi Router Password."

If your coach is a New Aire, Mountain Aire, London Aire, Supreme Aire, Essex, or King Aire equipped with the SilverLeaf coach management system, it is highly recommended that you read and perform the instructions for "Changing the SilverLeaf LR125 Password" to provide full functionality of the coach management system.

⚠ CAUTION

Failure to change these passwords poses a potential security risk to you and your coach.

Passwords should be at least 12 characters long. The longer the password is, the harder and longer it takes to crack.

- Include upper case letters, lower case letters, and special characters (i.e., #, !, &).
- Never use the exact same password for all your systems.
- Recommend a passphrase that contains a series of unrated words.
 - Passphrases greatly increase the difficulty of this type of software. To create a passphrase think up a short, silly story: "The buffalo drove the truck to the store." To create a passphrase from this, you simply select words and string them together, and make a few substitutions: BuffaloTruckStOre! While it may seem silly, it is incredibly easy to remember, so long as you remember the story. Your stories can be anything you want, just make sure it's something easy to visualize and sticks in your head."

Changing The WiFi Router Password

CONNECT TO THE COACH NETWORK

⚠ NOTICE

These instructions are intended for WiFi Ranger (WFR) GO2 and CONVERGE (Teton/Poplar, Denali/Spruce, and Everest/Aspen) Products. To change the Guest WiFi password, please refer to the user guide by typing "WiFi Ranger User Guide" (including the quotation marks) in the Newgle search bar.



1. Search for the 'Newmar Network' in the coach when scanning for network connections.
 - a. It is identified by "NewmarXXYY." Pick the network that has the identifier that matches the sticker on the indoor router.
 - b. Each coach model has an identifier for the password, as seen below.
2. Enter the password according to the coach identifier.

EXAMPLE COACH INFO:

WFR ID #: 778XXX

Model: King Aire Diesel Bus

Serial #: 530XXX

Customer WiFi Signal	
Example ID	778XXX
SSID Broadcast	NewmarXXYY
WPA Key (Password)	KGDB530XXX

RELEVANT COACHES

COACH MODEL	YEARS EQUIPPED	SSID XXYY = LAST 4 of WFR ID#	PASSWORD ModelCoach#
King Aire	2014+	NewmarXXYY	KGDB530XXX
Essex	2015+	NewmarXXYY	EXDP801XXX
London Aire	2018+	NewmarXXYY	LADP501XXX
Mountain Aire	2018+	NewmarXXYY	MADP904XXX
Supreme Aire	2020+	NewmarXXYY	SACC270XXX
New Aire	2018+	NewmarXXYY	NADP710XXX
Dutch Star	2018+	NewmarXXYY	DSDP604XXX
Ventana	2018+	NewmarXXYY	VTDP413XXX
Ventana LE	2018+	NewmarXXYY	VLDP413XXX
Super Star	2020+	NewmarXXYY	SSCC230XXX
Kountry Star	2018+	NewmarXXYY	KSDP750XXX
Canyon Star	2018+	NewmarXXYY	CSCA160XXX
Canyon Star Front Diesel	2021+	NewmarXXYY	CSFD162XXX
Bay Star	2018+	NewmarXXYY	BSCA140XXX
Bay Star Sport	2018+	NewmarXXYY	BTCA110XXX

3. After connecting to the coach network, open an internet browser and type in 'MYWIFIRANGER.COM' in the address bar to connect to the WiFi Ranger control panel.



4. In the address bar of the internet browser, remove any text following ":8080" and then type in '/admin' after the ':8080'.
 - a. Example: 10.189.90.1:8080/admin
 - b. This will go to a username and password screen for the admin credentials.



5. Enter USERNAME: admin
6. Enter PASSWORD: wfradmin



7. In the WPA KEY setting, change password to one decided by the customer.
 - a. After the password is changed click 'SAVE CHANGES'.

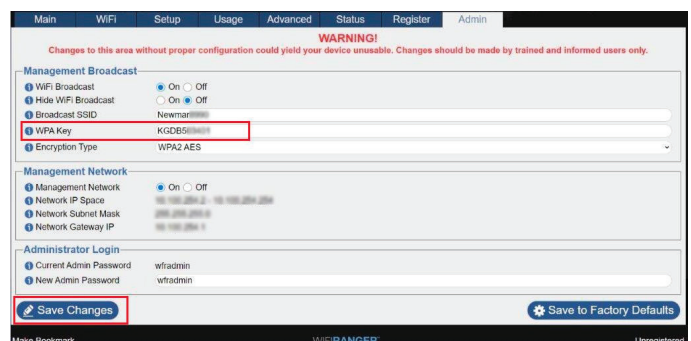

- A banner will show up when the changes are being made. When the password is changed, the banner should show:



- Once the settings have been changed, reconnect to the network using the new password.
- Set up is complete!

Changing The WiFi Ranger Control Panel Password

For more security in the WiFi Ranger (WFR), it is suggested to make a change in the Control Panel that will require a USERNAME and PASSWORD when trying to get access to the WFR Control Panel. Complete the following procedure to further enhance the security.

- Enter the control panel by first connecting to the Newmar Network in the coach as explained previously in the “Connect to the Coach Network” section.
- When connected, go to the SETUP tab and make sure the HIDE ADVANCED FEATURES selection is turned off.
 - If it is ON, select OFF, and click SAVE CHANGES.

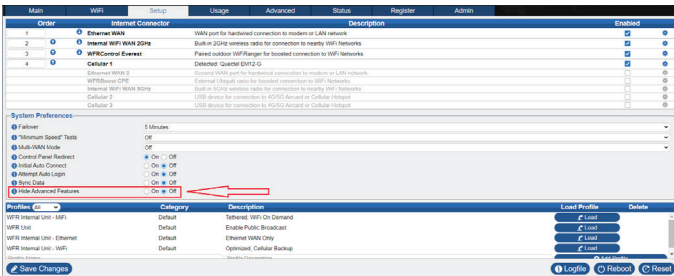

- From there, click the ADVANCED tab.
- In the last box labeled ADMIN ACCESS, choose “ON.”
- Change the USERNAME and PASSWORD to something different.
 - To make this as safe and secure as possible, do not share this password.

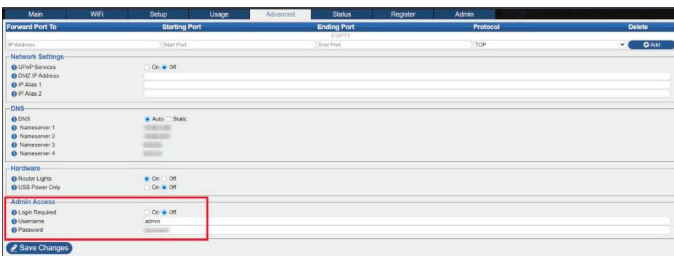

- Click SAVE CHANGES.
 - The next time you try and enter the Control Panel, you will need this username and password to gain access.

- Passwords to WiFi-enabled devices like televisions, cameras, and sound bars (i.e.: Bose 700 sound bar used on select Mountain Aire, London Aire, Supreme Aire, Essex, and King Aire coaches) will also need to be updated to have the same new password as the router in order to re-establish the pairing and connectivity between each of those WiFi devices and the router. Please refer to the manufacturer’s operation manual for pairing instructions for each WiFi-enabled component.

- Setup is complete!

Changing The SilverLeaf LR125 Password



- Start on the SilverLeaf Home screen.
- Press the CONFIG button on the lower right-hand side of the Home screen.



- Scroll to the last page using the down arrow on the lower right-hand side of the CONFIG screen.

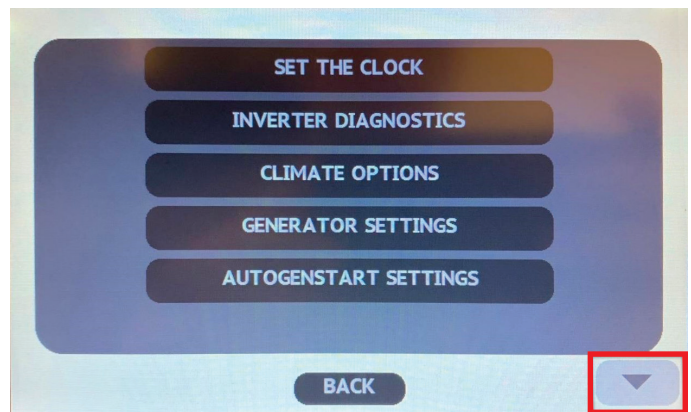

- Change SETTINGS LOCK CODE using the up or down arrows, setting this number to “42.”

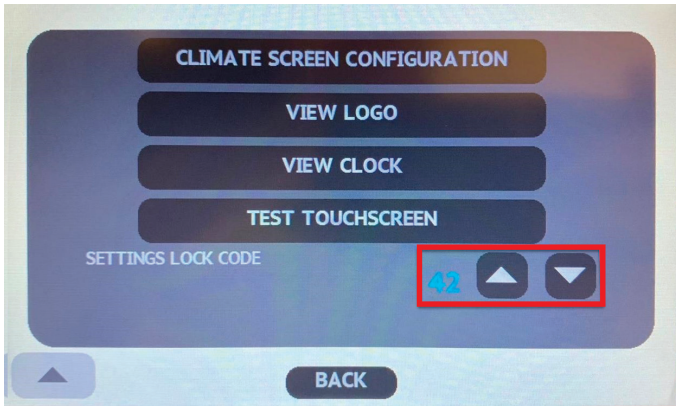

5. Scroll up twice using the navigation arrow and select TABLET WIFI / ROZIE SETTINGS.

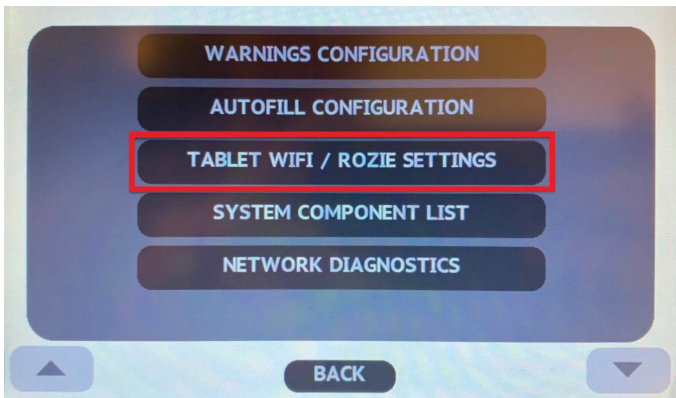

6. Scroll down once to the Router Password, and press the CHANGE button.

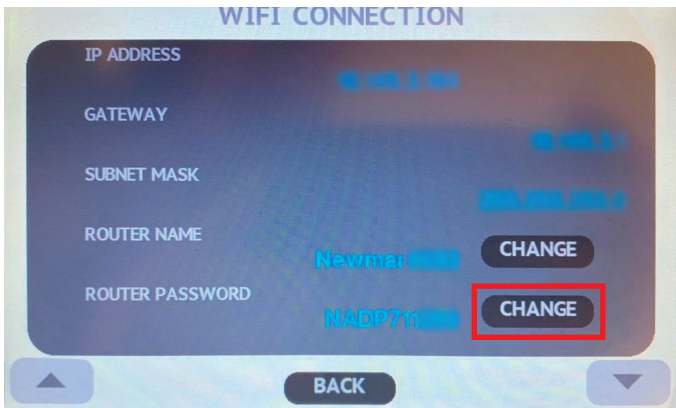

7. Enter your new password using the keypad, and select ACCEPT once your password is complete.

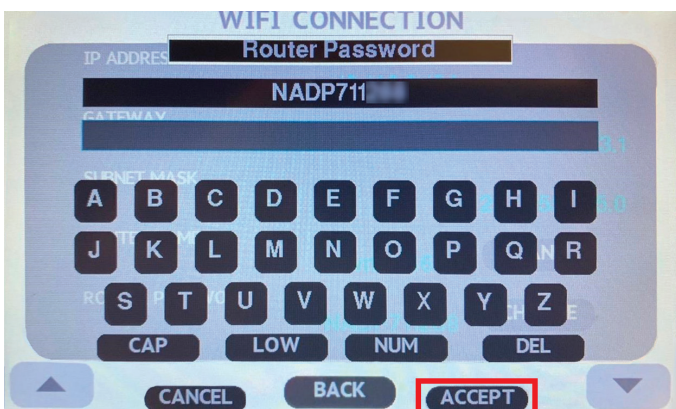

8. Select the BACK button to return from the TABLET WIFI / ROZIE SETTINGS screen to the CONFIG screen.

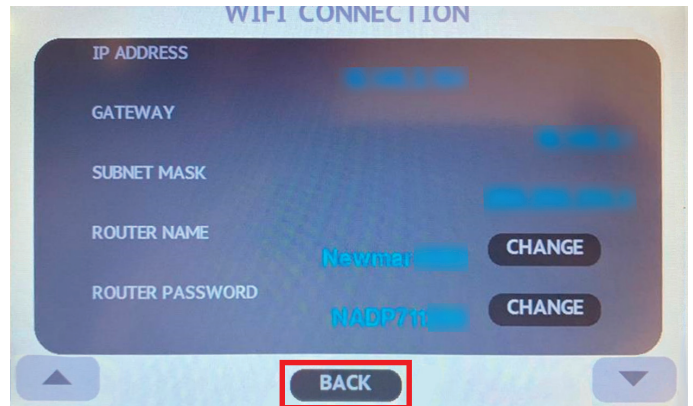

9. Select MONITOR CONFIGURATION from the options.

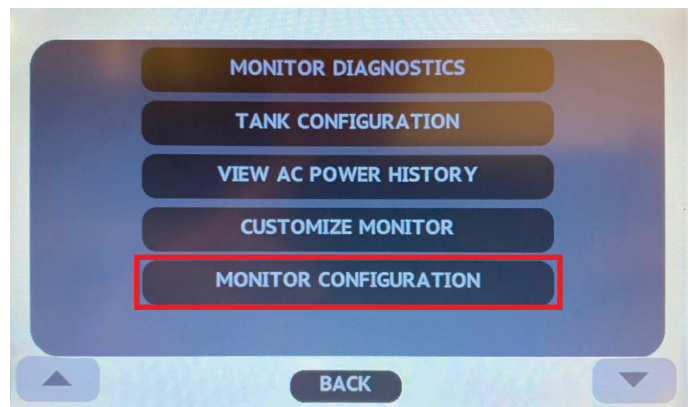

10. Using the down arrow, scroll to the last page of the MONITOR CONFIGURATION screen. Then select the REBOOT button.



After REBOOT is selected, the SilverLeaf monitor will return to the HOME screen, and your new password is saved.

This page is intentionally blank.



ENTERTAINMENT SYSTEMS

This chapter provides information on entertainment components, including televisions, dash-mounted audio equipment, multi-disc players, home theater systems, and satellite antennas. Such components may be located within your coach's living room, bedroom, cargo area, or even outside the coach in an optional exterior entertainment center.

⚠ IMPORTANT

Any of the following quick start instructions provided by Newmar should not take the place of the manufacturer's complete documentation. Refer to Newgle for more information about entertainment components offered for your coach's model year.



Antennas, Cable, and Satellite Systems

Antennas and Cable Overview

This article provides an overview of the antenna and cable system in the coach. Your coach may be equipped with an exterior antenna jack and interior antenna jacks or wiring at each television location. Depending on your coach year, model, and options, several antennas have been used.

Antenna Power Booster

An antenna with a power booster may be installed in your coach and is designed for reception of all local color and black-and-white channels. The antenna may be automatic, stationary, or manual lift. The power booster supplies voltage to the antenna when using over-the-air signal. However, it transfers the connection from the antenna to park cable when it is available and connected.

To operate the power booster for the television signal, press the switch on the booster plate to illuminate the green LED light. This will supply power to the antenna and boost the television signal.

When using park cable, the booster must be turned off to allow the signal to bypass the antenna and connect to the television or selector switch through the same coax cable. The green LED light should not be illuminated.

A 12 volt outlet is also provided for 12 volt accessories. Do not use this outlet for a cigarette lighter.

Over-The-Air Signal

If the reception is poor, make sure the power switch for the power booster is in the "ON" position and all of the coax connections are tight. This switch is usually located beside the passenger chair or on the video selector box (select units only).

On coaches with a Rayzar automatic TV antenna, this switch is integrated into the power on/off switch typically located in the overhead control center. After traveling, it may be necessary to auto-program your televisions to pick up local stations.

Cable Connection

An exterior cable jack and receptacle may be available on your coach. If installed, they may be located in an outside storage compartment, usually near the power cord.

When using park cable, it is necessary to turn the antenna booster off in order to allow the signal to travel to the television or selector switch (if equipped). This switch is usually located beside the passenger chair; it can also be the power button on the video selector box (select units only).

On coaches with a Rayzar automatic TV antenna, this switch is integrated into the power on/off switch typically located in the overhead control center.

⚠ IMPORTANT

Failure to turn off the power booster switch to the antenna while using the park cable system may cause poor picture quality.

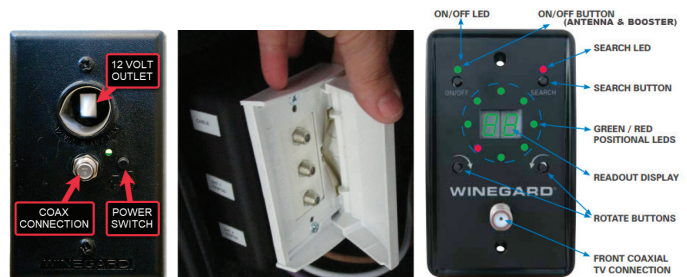

Antenna Power Booster

Cable Connection with Optional Tripod Satellite Connections

Winegard Rayzar Antenna

Basic Troubleshooting

If you have poor reception, try these simple solutions:

1. Make sure the power booster or Rayzar antenna system is turned off.

2. Make sure the coax cable from the park cable hookup to the basement of the coach is in good, working condition and does not have a shorted shield wire.

3. Each TV will need to be set for cable and auto programmed at each new campsite location.
4. Any further troubleshooting and diagnosis should be performed by an authorized service technician.

Winegard Rayzar Automatic Antenna Operation (Models: RZ-7500, RZ-7535, RZ-8500, RZ-8535)

This article provides information about the control panel, cable and antenna mode, and the automatic search function of a Winegard Rayzar Automatic Antenna (Models: RZ-7500, RZ-7535, RZ-8500, RZ-8535).

Control Panel

Coaches equipped with a Rayzar Automatic Antenna will also be equipped with a control panel in the overhead cabinet.

Cable Mode

When the control panel is powered off, park cable signals will be passed to the TV. In this mode all LEDs are turned off.

⚠ IMPORTANT

Failure to turn off the power booster switch to the antenna while using the park cable system may cause poor picture quality.

Antenna Mode

When the Control panel is powered on by pressing the On/Off button, the LEDs will flash and begin its power on process. At this time the antenna amplifier is powered on and TV antenna signals will be passed. Initially, GREEN "Positional LED(s)" will be lit to indicate the direction the antenna is positioned.



Automatic Search Function

The system does not move until the Search button is pressed. Channels will be received whenever the system is powered on.

To begin a new search, press the Search button. The antenna will go through its initialization process and begin searching for TV frequencies. A typical search will take 2-3 minutes. A RED LED will quickly cycle through the positional LED position to indicate the antenna is moving and direction it is moving. After the search is complete, the antenna will automatically go to the position which results in the most watchable TV channels. The 2-digit display will show the number of frequencies seen at that position, and both the GREEN and RED LED(s) will be lit to indicate the successful search location.

Additional RED LEDs will also light to show any other channels found at alternate positions. Pressing the Search button again will move the antenna to the next best location. Continuing to press Search again will cycle through other positions that provided additional channels, until returning to the main search location. To clear search results and initiate a new search, press and hold the Search button for 2 seconds. The system will also clear all search results each time it is powered off.

Source(s): Winegard Rayzar Automatic Antenna User Guide

Product(s): This source is associated with more than one product. Refer to Newgle for more information about the product(s) offered for your coach's model year.

Winegard RoadTrip T4 Automatic In-Motion Satellite Operation (Model: RTT-20B/RT2000T)

This article provides basic operation instructions for a Winegard RoadTrip T4 Automatic In-Motion Satellite (Model: RTT-20B/RT2000T).

Operating The Roadtrip® T4 Antenna

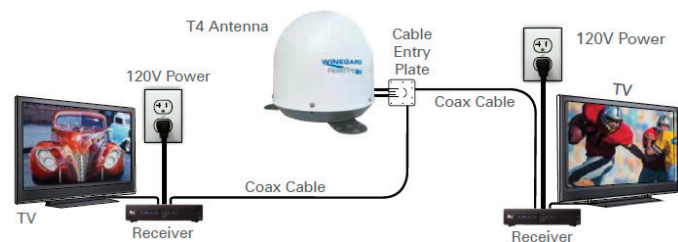

1. Turn on receiver and television set. The RoadTrip® T4 antenna must be connected to a receiver plugged into 120VAC.
2. Verify that you are getting the receiver's menu screens on the television. These screens are available with or without the dish finding the signal.
3. Ensure receiver is properly configured for your provider.

4. Turn the power switch on for the antenna. Within 10–15 seconds, the dish will begin moving and should make one or two revolutions during startup. During this process, it is normal to hear a slight grinding sound as the unit checks its rotational limits. This does not harm the unit. The system will pause to acquire GPS.
5. Once the dish begins its search, it pauses on signals long enough to determine which satellite it has found. The antenna may move off the signal in an effort to verify the signal and should return shortly.

TIP: Because the T4 antenna uses information from the last location where it was on signal, satellite acquisition may take longer if the dish is inactive over long distance traveling.

6. After the T4 has verified the correct satellite, it will continue to track the signal. The unit will go into “Sleep Mode” if the vehicle is stationary for 6 minutes. This involves a quick verification process where signal may be lost, then return to the signal and be silent. If the vehicle begins moving greater than 10 MPH, the in-motion T4 will resume tracking mode. For smoother operation, use your on-screen guide to locate your channel rather than “channel surfing.”
- NOTE There are certain areas within the U.S. where the T4 antenna may experience limited or no coverage of the 129° satellite for HD programming. DISH home coverage has the same limitations. Problem areas include Washington, Oregon and California, but limited coverage may extend past these areas. Contact DISH for additional coverage questions (1-888-825-2557).
 - ALSO when the T4 dome is blocked (example: while going through a tunnel, under a bridge, by a building, etc.) programming will not be available. Once the block is removed, the programming will return.

DirecTV®

The RoadTrip® T4 antenna switch settings are preset for DIRECTV. If you have a DISH or Bell TV receiver, you must change the numbered switches found on the electronics box under the dome.

RECEIVER SETUP

Connect the receiver to a power source, and complete receiver setup. Check out online receiver setup guides for your antenna at www.winegard.com/support.

RECEIVER RECOMMENDATIONS

The RoadTrip® T4 antenna will operate with most DIRECTV receivers. Winegard does not recommend using receivers with hard drives, as they are not intended for mobile applications. Winegard does not recommend using an HD receiver since HD programming will not be available. SWM only receivers require a SWM-840 kit.

SATELLITE COVERAGE

The antenna will locate and toggle between satellites 101° and 119°. The RoadTrip® T4 antenna will not operate in all areas where satellites 101° and 119° are available. The T4 antenna is not compatible with 110° or KA-band satellites 99° and 103°. Satellite coverage maps are based on level, stationary operation. Reception interruption may also occur during adverse weather conditions.

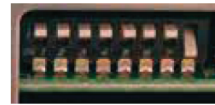

(factory preset for DIRECTV)

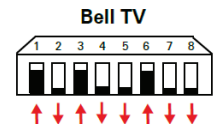
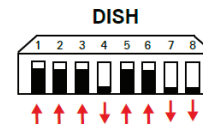
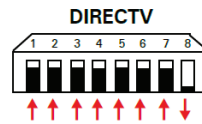
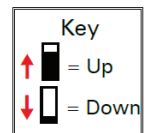

Maintenance

The RoadTrip® T4 antenna is designed to be maintenance free. However, it is a good idea to clean the dome from time to time with a soft cloth, water, and dish soap.

Source(s): Winegard RoadTrip T4 Automatic In-Motion Roof-Mounted Satellite TV Antenna User Guide

Product(s): Winegard T4 RoadTrip In-Motion Satellite (Model: RTT-20B, Newmar Part Number: 135606P)

Winegard Trav'ler Pro Automatic Multi-Satellite TV Antenna Operation (Models: SK2-100/SK2DISH and SK2-300/SK2SWM3)

This article provides basic operation instructions for a Winegard Trav'ler Pro Automatic Multi-Satellite TV Antenna (Models: SK2-100/SK2DISH and SK2-300/SK2SWM3).

IDU Operation

The already simple Winegard® Trav'ler® operation is even easier and can now be done from your smartphone with the Winegard-Connected app. To take advantage of advanced features and over-the-air updates, please download the Winegard-Connected app from the Google Play or the App Store. Simply plug in the 48 VDC power cable to power on the interface box (IDU) and start enjoying the Winegard Trav'ler Pro.

1. The IDU will power on as soon as the 48 VDC power cord is plugged into the IDU. This will not raise the antenna.
2. Upon power up, the IDU will display current hardware and software versions. If connected to an internet source (WiFi configuration requires the Winegard-Connected app), the IDU will check to see if any updates are available to download.
NOTE: When downloading a software update, make sure you have a good, reliable internet source and connection .
3. Once the IDU has loaded and is in the ready state, press and hold the Search button to perform a search.
4. To stow the antenna press and hold the Stow button until the satellite antenna starts the stow process.

The IDU includes advanced features as well as system information within the Settings Menu. To access the Settings Menu press and hold the Power button for five seconds until the Settings Menu options appear. Press Search to scroll up and Stow scroll down. An asterisk icon shows which menu item is currently selected. Press the Power button to confirm your selection. To exit a selected Power Mode, press and hold the Power button for five seconds and select the desired mode.



Smart Phone Operation and Features

To pair your smartphone with the IDU, open the Winegard-Connected app and log in to your account.

NOTE: Account creation is required to proceed. If you need to create an account press “Don’t have an account? Create one” under “SIGN IN” and complete the prompted fields. Once submitted, you will receive a confirmation link sent via email. If the email is not in your [email inbox] be sure to check your spam/junk folder. Once the link has been confirmed, you can now sign in to your account.

App Functions

The Main Menu shows all the additional features of the Winegard-Connected app. Available functions include: Power Modes, Search Mode, Stow Mode, Setting up WiFi, Disconnect and Reconnect to IDU, and Settings.

For more information about available functions and settings (antenna type, search mode, raise antenna, adjust antenna, WiFi network, EL calibration), refer to the complete operation manual.

SUPPORT

Download the product manual through the Winegard-Connected App. The app will prompt you to select a product. Once selected, press “GET MANUAL” to start the download process.

SYSTEM INFORMATION

The System Information option provides specific details about your Trav'ler Pro antenna, including its hardware version, software version, WiFi MAC address, SSID, and Bluetooth® MAC address.

To exit, scroll through the information screens until Exit Info is shown, then press and hold “Power”. The same information is available in the Winegard-Connected app and can be accessed through the System Info tab in the Trav'ler Pro Main Menu.

Update Software

Software updates require a reliable internet source and connection. Having a weak connection may create issues with the software download. When a software update is available, there will be an exclamation mark within the cloud icon on the IDU display. In the Winegard-Connected app there will also be a red circle with an exclamation mark within the messaging portion of the Trav'ler Pro Main Menu indicating a software update is available.

⚠ WARNING

It is highly recommended that the unit is stowed before performing any updates.

NOTE: When first setting up the Winegard Trav'ler Pro, it is recommended to connect to an internet source and check for software updates.

For more information about software updates, refer to the complete operation manual.

Miscellaneous

EMERGENCY POWER OFF

The antenna comes with an emergency power off feature. If you need to stop the Trav'ler Pro antenna at any time during a Search or Stow sequence, press "Search", or "Stow" again (i.e. repeat the same command) to stop the antenna. The antenna will stop in its current position and power will be disconnected from the ODU. Once the antenna has stopped, the ODU will automatically reboot and wait for the next command. If the emergency power off feature is used, the antenna may not be in a safe position for travel. Do not move the vehicle until the unit is stowed.

In addition to the Emergency Power Off, you can also perform an Emergency Reset. To do this you need to press all three buttons (Power, Search, and Stow) at the same time. This will immediately cycle power to the IDU and force a restart. Once the IDU restarts, it will come to the ready state and wait for a request.

EMERGENCY MANUAL STOW

If unable to stow the Trav'ler Pro antenna, it may be necessary to manually stow the antenna in order to travel. Emergency Manual Stow is meant to be used as a last resort and is not meant for common usage.

1. To perform the Emergency Manual Stow, make sure the power to the IDU is disconnected.
2. Once disconnected, proceed to the roof and remove the six Phillips screws and housing from the turret.
3. Disconnect the motor assembly cable from the motor and three 9/64" Allen screws to remove the motor from the turret.
4. To lower the antenna, use a 12mm 6-point socket on the elevation motor's square shaft and turn the shaft clockwise to lower the antenna.
5. Once lowered to the stow position, reconnect the motor assembly cable prior reinstalling the motor.
6. Once the assembly cable is connected, be sure the motor coupler is aligned with the shaft.
7. After aligning the motor, install the three 9/64" Allen screws (Torque – 25 in-lbs).
8. Verify the seal of the gasket prior to aligning the plastic housing over the screw holes, and seat the housing on the gasket.
9. Reinstall the six Phillips screws. Do not use a drill, as you can strip the base.

⚠ NOTICE

Before lowering the antenna be sure to antenna will stow towards the back of the vehicle. On the mount base, the transition plate is marked "FRONT" and "BACK." If the antenna is not in a position to stow towards the back of the vehicle, remove the AZ motor assembly cable from the top of the motor and rotate the antenna by hand until the antenna is aligned with "BACK" on the transition plate. Once aligned, reconnected the AZ motor assembly cable and lower the antenna.

MANAGE DEVICES

Managing devices can be done from the Device Selection/Add New Device page by pressing the Menu button (3 bars top left) and selecting Manage Devices under My Tools. The Manage Devices screen gives you the ability to register a new device, remove a device, and manage authorized users for devices.

To register a new device, press the green plus sign next to Register New Device at the bottom of the page. To remove a device, press the trash icon.

Add an authorized user by pressing the green plus sign next to the device. Then select "Add New User". At this point, you will be asked to enter the person's name, email address, and select if they are the owner or a guest. Owner access will not expire whereas if you want to give someone temporary access, set the owner field to "false" and set "expires on" to the desired date. The guest access is intended to be set up for anyone needing temporary access such as a dealer or mobile technician. The IDU has the ability to pair five devices to it.

Source(s): Winegard Trav'ler Pro Automatic Multi-Satellite TV Antenna Operation Manual Rev5-21 (Models: SK2DISH, SK2SWM3)

Product(s): Winegard Trav'ler Pro Automatic Multi-Satellite TV Antenna (Models: SK2-100/SK2DISH, Newmar Part Number: 161392)

Winegard Trav'ler Pro Automatic Multi-Satellite TV Antenna (Models: SK2-300/SK2SWM3, Newmar Part Number: 161393)

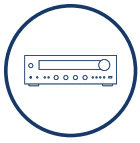

Audio Systems

Bose TV Speaker Operation (Model: 838309-1100)

This article provides basic operation instructions for a Bose TV Speaker (Model: 838309-1100).

Remote Control

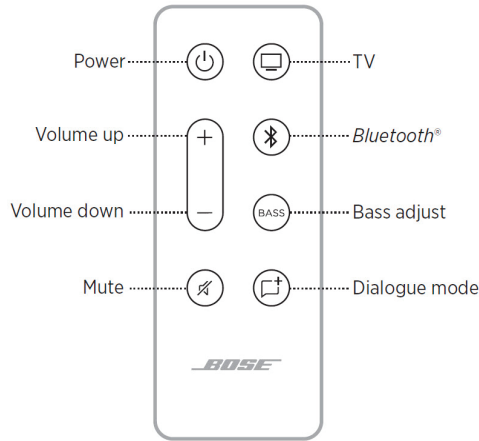

POWER

On the remote, press the Power button to power the speaker on/off. When powered on, the speaker defaults to the last active source.

- When you plug the speaker into an AC (mains) outlet, the speaker automatically powers on.
- The first time the speaker is powered on, the speaker defaults to the TV source.
- If the speaker is connected to the TV using an HDMI cable, the speaker changes to the TV source whenever the TV is powered on.

AUTO-WAKE

You can set the speaker to power on whenever a sound signal is received from an optical or analog cable. On the remote press and hold the Power button **I** until you hear a tone and the TV and Bluetooth lights on the speaker blink amber 3 times to switch between auto-wake and default power settings.

VOLUME

Volume Up: Press +. NOTE: To quickly increase the volume, press and hold +.

Volume Down: Press -. NOTE: To quickly decrease the volume, press and hold -.

Mute/Unmute: Press the Mute button. When audio is muted, the light on the speaker of the current source (TV or Bluetooth) pulses white until audio resumes. TIP: You can also press + to resume audio.

SOURCES

You can control your TV and Bluetooth connections using your remote. To control a source, press the TV button or Bluetooth button) on the remote for the source you want to control.

DIALOGUE MODE

Dialogue mode improves the clarity of dialogue and vocals in movies, TV programs, and podcasts by adjusting the audio balance of the system. On the remote, press the Dialogue mode button to switch between Dialogue mode and your default audio settings. When Dialogue mode is enabled, the light for the current source glows green.

Note: When you enable Dialogue mode, it stays enabled for your current source even if you switch to another source or turn off the speaker. To disable Dialogue mode for a source, press the Dialogue mode button again.

ADJUST THE BASS

1. On the remote, press BASS. On the speaker, the TV and Bluetooth lights blink white 3 times.
2. Adjust the bass by doing one of the following:
 - Press Volume up (+) to increase the bass.
 - Press Volume down (-) to decrease the bass.

The TV and Bluetooth lights on the speaker glow to show the current bass setting.

3. Press BASS. The speaker saves the current bass setting.

RESET THE BASS

On the remote, press and hold BASS until the TV and Bluetooth lights on the speaker blink 3 times. The bass settings reset to original factory settings.

BLUETOOTH

1. On the remote, press the Bluetooth button. The Bluetooth light slowly pulses blue.
2. On your mobile device, enable the Bluetooth feature. TIP: The Bluetooth menu is usually found in the Settings menu.
3. Select Bose TV Speaker from the device list. Once connected, you hear a tone. The Bluetooth light glows solid white. Bose TV Speaker appears in the mobile device list.

Media Playback and Volume Status

LIGHT ACTIVITY	SYSTEM STATE
TV light is solid white	Power on TV
Bluetooth light is solid white	Connected to a Bluetooth device
TV light is solid green	Dialogue mode enabled for TV
Bluetooth light is solid green	Dialogue mode enabled for Bluetooth-connected device
TV light blinks white	Changing volume for TV
Bluetooth light blinks white	Changing volume for Bluetooth-connected device
TV light blinks green	Changing volume in Dialogue mode for TV
Bluetooth light blinks green	Changing volume in Dialogue mode for Bluetooth-connected device
TV light slowly pulses white	Mute enabled for TV
Bluetooth light slowly pulses white	Mute enabled for Bluetooth-connected device
TV light slowly pulses green	Mute enabled in Dialogue mode for TV
Bluetooth light slowly pulses green	Mute enabled in Dialogue mode for Bluetooth-connected device
TV light blinks red	Speaker error - disconnect from power then reconnect. If error persists, contact Bose customer service.

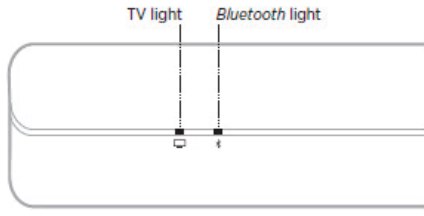

LIGHT ACTIVITY	TV light	Bluetooth light	SYSTEM STATE
Bluetooth light slowly pulses blue	■	⚡	Ready to connect
Bluetooth light blinks white	■	⚡	Connecting
Bluetooth light glows white	■	■	Connected

Speaker Status

The LED lights located on the front of speaker show the speaker status. The lights display the current sources highest priority status.

Source(s): Bose TV Speaker Start Guide

Product(s): Bose TV Speaker (Model: 838309-1100, Newmar Part Number: 155172)

Bose Smart Soundbar Operation (Model: 900) Model #: 863350-1100

This article provides basic operation instructions for a Bose Smart Soundbar (Model: 900).

Soundbar Controls

The soundbar controls are located on the top of the soundbar and on the remote. TIP: You can also control your soundbar using the Bose Music app.

REMOTE FUNCTIONS

Use the remote to control the soundbar, Bluetooth connections, and presets.

POWER ON/OFF

On the remote, press the Power button to power the soundbar on/off. When powered on, the soundbar defaults to the last active source.

Notes:

- When you plug the soundbar into an AC (mains) outlet, the soundbar automatically powers on.
- You can still access your voice assistant when the soundbar is powered off.
- You can also use Voice4Video™ to power the soundbar on/off.

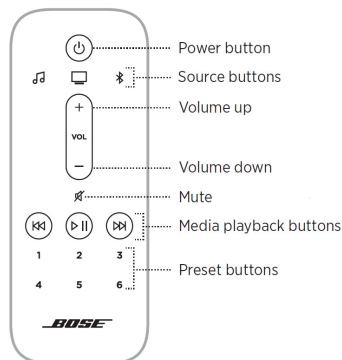

AUTO-WAKE (OPTICAL CONNECTION ONLY)

You can set the soundbar to power on whenever a sound signal is received. To toggle between auto-wake and default power settings, press and hold I for 10 seconds until you hear a tone and the light bar pulses white twice. TIP: You can also control auto-wake using the Bose Music app. You can access this option from the Settings menu.

SOURCES

You can control your TV, Bluetooth connections, and Bose Music app audio using your remote. To select a source, press the appropriate button (Bose Music app, TV, or Bluetooth) on the remote.

Tips:

- You can also use Voice4Video™ to select your Bluetooth source.
- You can also use the Bose Music app to select a source.

PRESETS

The soundbar includes 6 presets that you can set to play audio from your favorite music services. Once set, you can access your audio, at any time, with a simple touch of a button on the remote or using the Bose Music app.

MEDIA PLAYBACK AND VOLUME

Function	Symbol	What To Do
Play/Pause		Press the Play/Pause button. When audio is paused, two lights in the center of the light bar glow solid white until audio resumes. You can only play/pause audio when the Bose Music app or a Bluetooth connection is your source.
Skip Forward		Press the Skip Forward button.
Skip Backward		Press the Skip Backward button.
Volume Up		Press +. To quickly increase the volume, press and hold +.
Volume Down		Press -. To quickly increase the volume, press and hold -.
Mute/Unmute		Press the Mute button. When audio is muted, the left end of the light bar glows solid white until audio resumes. You can also press + to unmute audio.

VOICE ASSISTANT CONTROLS

You can use the Action button and Microphone off button to control Google Assistant or Amazon Alexa (refer to complete manual for more information).

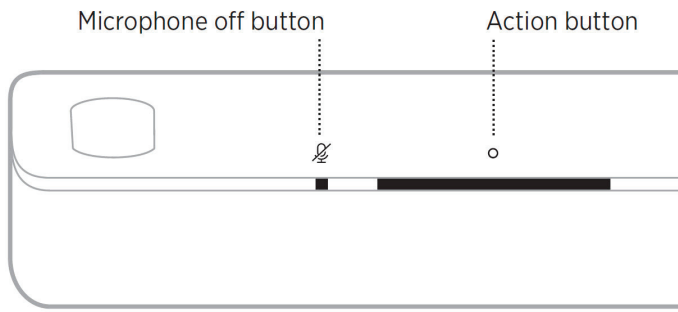

Preset Personalization

You can control presets using the Bose Music app or the remote. NOTE: You can't set presets when your source is a Bluetooth connection.

SET A PRESET

1. Stream music using the Bose Music app.
2. On the remote, press the Bose Music button.
3. Press and hold a preset button until you hear a tone.

PLAY A PRESET

1. Once you personalize presets, press a preset button on the remote to play music.

CONNECT A MOBILE DEVICE

1. On the remote, press the Bluetooth button. The light bar pulses blue.
2. On your mobile device, turn on the Bluetooth feature. NOTE: The Bluetooth menu is usually found in the Settings menu.
3. Select your soundbar from the device list. NOTE: Look for the name you entered for your soundbar in the Bose Music app. If you didn't name your soundbar, the default name appears. Once connected, you hear a tone, and the light bar glows solid white then fades to black. The soundbar's name appears in the mobile device list.

DISCONNECT A MOBILE DEVICE

Use the Bose Music app to disconnect your mobile device.

TIP: You can also use Bluetooth settings on your mobile device. Disabling the Bluetooth feature disconnects all other devices.

RECONNECT A MOBILE DEVICE

On the remote, press the Bluetooth button. The soundbar tries to connect with the most recently-connected devices.

Notes:

- Make sure the Bluetooth feature is enabled on your mobile device.
- The device must be within 30 ft (9 m) and powered on.

CONNECT AN ADDITIONAL MOBILE DEVICE

You can store up to eight devices in the soundbar device list.

NOTE: You can play audio from only one device at a time.

1. On the remote, press and hold the Bluetooth button until the light bar pulses blue.
2. On your mobile device, select your soundbar from the device list. NOTE: Make sure the Bluetooth feature is enabled on your mobile device.

CLEAR THE SOUNDBAR DEVICE LIST

1. On the remote, press and hold I for 10 seconds until the light bar pulses white twice then fades to black. The light bar pulses blue.
2. Delete the soundbar from the Bluetooth list on your device. All devices are cleared, and the soundbar is ready to connect.

Soundbar Status

The LED light bar located on the front of the soundbar shows the soundbar status.

NOTE: The light bar displays one status at a time of the selected source.

- **Wi-Fi Status:** Shows the Wi-Fi connection status of the soundbar.
- **Bluetooth Status:** Shows the Bluetooth connection status of mobile devices.
- **Voice Assistant Status:** Shows the status of your voice assistant.

For more information about status lights, refer to the complete manual.

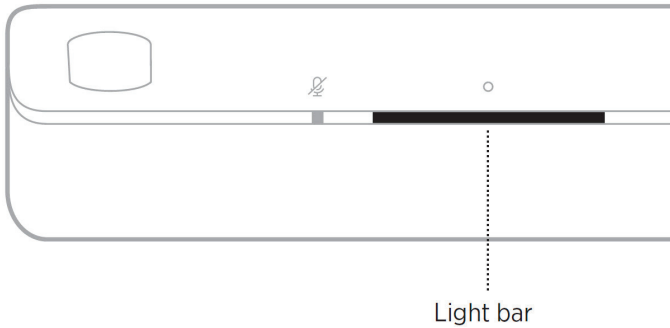

Care and Maintenance

Wipe the outside surfaces of the soundbar with a soft, dry cloth.

⚠ CAUTION

- **Do NOT allow liquids to spill onto the soundbar or into any openings.**
- **Do NOT blow air into the up-firing speakers or soundbar.**
- **Do NOT use a vacuum to clean the up-firing speakers or soundbar.**
- **Do NOT use any sprays near the up-firing speakers or soundbar.**
- **Do NOT use any solvents, chemicals, or cleaning solutions containing alcohol, ammonia, or abrasives.**
- **Do NOT allow objects to drop into any openings.**

Source(s): Bose Smart Soundbar 900 Owner's Guide (2021)

Product(s): Bose Smart Soundbar (Model: 900, Newmar Part Number: 161021)

Bose Bass Module Operation (Model: 500)

This article provides basic operation instructions for a Bose Bass Module (Model: 500).

Status

The light on the back of the module shows system status.

LIGHT ACTIVITY	SYSTEM STATE
Solid White	Connectd to the soundbar
Blinking White	Downloading a software update
Solid Amber	Network standby (wireless connection)
Blinking Amber	Ready to connect to the soundbar
Off	Power-saving mode (wired connection)
Blinking Red	Error - contact Bose customer service

Choose Your Connection Method

The way you connect the bass module depends on your soundbar. Choose your connection method from the table below.

SOUNDBAR	CONNECTION METHOD
Bose Soundbar 500 or Bose Soundbar 700	Connect using the Bose Music app. Note: If you can't access or have trouble connecting using the Bose Music app, refer to the Troubleshooting section in the Bose Owner's Guide.
SoundTouch 300 Soundbar	Connect using your soundbar's remote.

CONNECT USING THE BOSE MUSIC APP

1. In the Bose Music app, from the My Bose screen, select your soundbar.
2. Tap the soundbar image in the bottom-right corner of the screen.
3. Tap Settings > Accessory Speakers > Add Bose Accessory Speakers. Follow the app instructions.

CONNECT USING THE SOUNDTOUCH 300 REMOTE

1. On your soundbar's remote, press the SoundTouch button.
2. Press and hold 7 until the connectivity light on the soundbar blinks white. Once connected, you hear a tone. The light on the back of the bass module and the connectivity light on the soundbar glow white. Connecting may take several minutes.

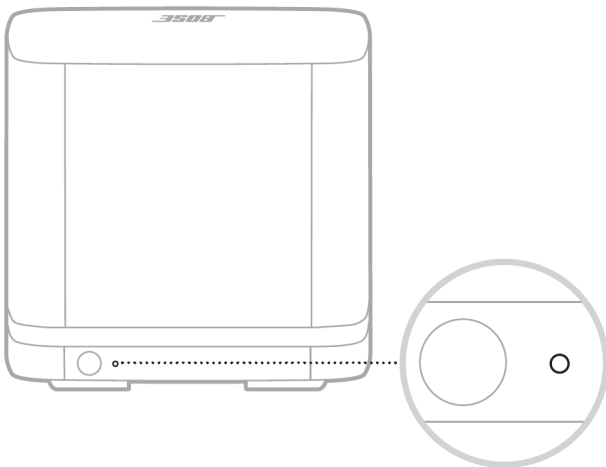

Choose Your Bass Adjustment Method

The way you adjust the bass depends on your soundbar. Choose your bass adjustment method from the table below.

SOUNDBAR	BASS ADJUSTMENT METHOD
Bose Soundbar 500 or Bose Soundbar 700	Adjust the bass using the Bose Music app
SoundTouch 300 Soundbar	Adjust the bass using your soundbar's remote. For optimal sound quality for dialogue-only programs, such as news and talk shows, enable dialogue mode.

ADJUST THE BASS USING THE BOSE MUSIC APP

Note: You can only adjust the bass using the app if your bass module is connected to the Bose Soundbar 500 or Bose Soundbar 700.





































1. In the Bose Music app, from the My Bose screen, select your soundbar.
2. Tap the soundbar image in the bottom-right corner of the screen.
3. Tap Adjustments to adjust the bass.

ADJUST THE BASS USING THE SOUNDTOUCH 300 REMOTE

1. On the SoundTouch 300 remote, press BASS. The lights on the soundbar glow according to the current bass setting.
2. Adjust the bass by doing one of the following:
 - Press Volume up button to increase the bass.
 - Press Volume down button to decrease the bass.
3. Press BASS. The soundbar saves the current bass setting.

RESET THE BASS

On your remote, press and hold BASS until the SoundTouch light on the soundbar blinks twice. The bass setting resets to original factory settings.

+4	    
+3	    
+2	    
+1	    
0 (default)	    
-1	    
-2	    
-3	    
-4	    

Source(s): Bose Base Module 500 Owner's Guide

Product(s): Bose Base Module 500 (Model: 796145-1100, Newmar Part Number: 151757)



Remotes

On select coaches, all of the entertainment equipment can be operated with the use of a single universal remote.

Harmony Advanced Infrared Universal Remote Control Operation (Model: HAH-665)

This article provides basic operation instructions for a Harmony Advanced Infrared Universal Remote Control (Model: HAH-665).

The Harmony 665 Advanced Remote Control is your answer to effortless home entertainment. The Activities buttons enable control of all your devices in one convenient remote. You can go from watching TV to watching a DVD to listening to music with the touch of an Activity button.

Getting To Know Your Harmony 665

A. The Activity buttons allow you to start your Activities. If an Activity does not start as expected, press the Help button and answer simple questions to get your Activity working the way you expect.

- There are 3 direct Activity buttons, plus a “More” button that will display additional Activities on the remote screen. After creating Activities using the Harmony software you can start your entertainment system with these one-touch buttons.

B. The buttons around the screen control the functions that appear on the screen such as favorite channels. It also gives you access to other commands and remote functions.

- Use the 4 side buttons to select items from the LCD screen. You can customize the commands that appear on your screen or even add Favorite Channels.
- The bottom button toggles between Activity and device mode. It’s best to always use your remote in Activity mode so Harmony can keep all your devices in sync.

C. The menu area controls your TV-screen guides and menu.



D. The color-coded buttons perform cable and satellite functions or you can customize them with your favorite commands.

- The Harmony 665 buttons are automatically mapped based on the Activity you’re in. While watching TV, the channel buttons will control your cable/satellite box. While listening to music, the channel buttons may change radio stations.

E. The channel area puts the most popular buttons at your fingertips. You can control the volume or change channels from one location.

F. The play area puts your play, pause, skip, and other buttons in one area for quick access.

G. The number pad.

FEATURES

Press the Off button to power off all your entertainment devices. Tip: You do not need to press Off when switching between two Activities. Harmony will remember what is already powered on and only change what’s needed.

There are 3 direct Activity buttons, plus a “More” button that will display additional Activities on the remote screen. After creating Activities using the Harmony software you can start your entertainment system with these one-touch buttons.

Two AA batteries come included with your Harmony 665. Remove the back battery cover and insert the two AA batteries into the remote.

Your new remote is configured by connecting your Harmony 665 to your laptop or desktop computer using the supplied USB cable, and signing in to the Harmony software.

Source(s): Harmony 665 Advanced Remote Control Setup Guide and Website

Product(s): Harmony Universal Remote Control Kit (Model: HAH665, Newmar Part Number: 151370)



Televisions

This article provides an overview of the televisions and related equipment installed in the coach. Your coach may be cable ready, and (depending on your floorplan) may have multiple flat screen televisions installed throughout the unit. The televisions are powered by 120 volt electricity, and the coach must be plugged into shore power, using the inverter (if equipped) or have the generator running in order for the televisions to function. The television operation is similar to most televisions used in the home.

The LED television(s) in your coach may be HD (High Definition) compatible, meaning they are capable of displaying the resolution and clarity of High Definition broadcasts and video sources.

Your coach may also be pre-wired for a satellite system and may be equipped with one interior television jack and an exterior television jack located on the passenger side of the coach. Choose the television source by selecting the input mode (air, cable, HDMI, etc.). The DVD player and satellite, if equipped, provides input to the front television(s) and exterior entertainment center. The bedroom DVD and satellite receiver, if equipped, provides input to the bedroom television.

Note: 2022 and newer models may not be equipped with DVD or Blu-Ray players installed at the factory.

⚠ IMPORTANT

The television in the front overhead cabinet will not operate while in transit. Federal regulations require this television to be inoperative while the vehicle is in use, so the power supply is switched off automatically when the ignition is turned on.

Exterior Entertainment Center with Samsung Television

This article provides a basic overview of the exterior entertainment center. For your convenience and pleasure, an Exterior Entertainment Center may be an option on selected floorplans. It may be located in either a basement compartment or in the sidewall of the passenger side of the coach and features a flat screen television.

Television

The television is mounted on a swivel bracket that allows you to swing the television out and away from the coach to provide better viewing angles. To release the television from its retainers, grasp the sides of the television firmly and pull it directly toward you. It will release and swing freely to the desired viewing position. To store the television for travel, swing it back into the opening, making sure that it is fully latched.

⚠ IMPORTANT

It is important to make sure the TV is securely locked into position prior to closing the compartment door. Failure to do so can result in damage to the television case and screen.

Soundbar Operation In Conjunction with Xite Radio

Depending on the year, model, and floorplan of your coach, this entertainment center may also feature a soundbar that will play whatever source is selected from the television when it is turned on (i.e. park cable, blu-ray player, satellite). While using the exterior television, the radio cannot be played through the soundbar.

⚠ IMPORTANT

The electronics used in the Exterior Entertainment Center are not designed for use in wet weather. The TV should be stored securely in the “travel” position and the basement door closed during rain or other adverse weather conditions. Caution should also be exercised when washing the exterior of your coach to make sure high pressure water does not enter the compartment. Spraying high pressure water at the seal between the doors can cause leaks, and potentially damage the electronics housed in this compartment.

The radio may be played through the soundbar via the Xite radio’s House Mode feature; however, the exterior television must be turned off. To play media through the soundbar using a separate device such as iPad, smartphone, etc., press the Bluetooth button on the soundbar and pair it with the desired device. For more information about the Bluetooth functionality, refer to the owner’s manual for your specific soundbar, which can be located in Newgle.



Samsung 4K UHD 7 Series Television Operation (Model: TU7000)

This article provides basic operation instructions for a Samsung 4K Crystal UHD 7 Series Television (Model: TU7000).

Remote Control Operation

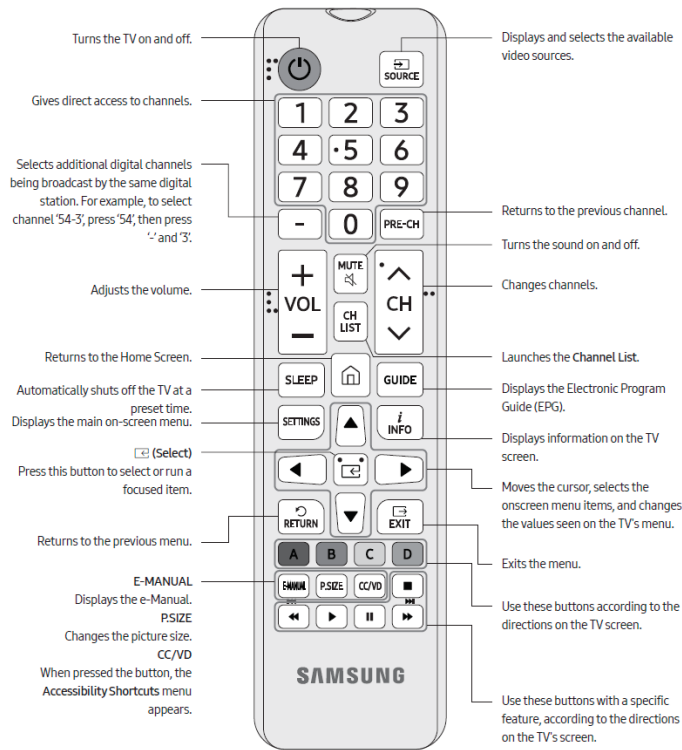

Accessing Samsung's E-Manual

You can view the embedded e-Manual containing information about your TV's key features. Press the menu button on the standard remote control to open the menu. Alternatively, press the button to open Smart Hub, press the left arrow until you reach settings, and then press Select.

Use the up and down arrows to move within this menu. Move to the Support option, select the e-Manual option, and then press Select to open it. The e-Manual contains two rows of buttons. Use the up and down arrows to move between rows and the left and right arrows to move within a row. Press Select to open the section you want to read.

Caring for the TV

- If a sticker was attached to the TV screen, some debris can remain after you remove the sticker. Please clean the debris off before watching TV.
- The exterior and screen of the TV can get scratched during cleaning. Be sure to wipe the exterior and screen carefully using a soft cloth to prevent scratches.
- Do not spray water or any liquid directly onto the TV. Any liquid that goes into the product may cause a failure, fire, or electric shock.
- To clean the screen, turn off the TV, then gently wipe away smudges and fingerprints on the panel with a micro-fiber cloth. Clean the body or panel of the TV with a micro-fiber cloth dampened with a small amount of water. After that, remove the moisture with a dry cloth. While cleaning, do not apply strong force to the surface of the panel because it can damage the panel. Never use flammable liquids (benzene, thinner, etc.) or a cleaning agent. For stubborn smudges, spray a small amount of screen cleaner on a micro-fiber cloth, and then use the cloth to wipe away the smudges.

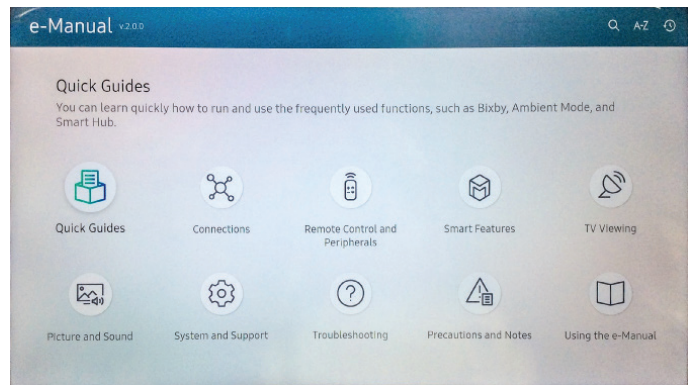

⚠ IMPORTANT

The Samsung e-Manual may contain features not applicable to your television.

Source(s): Samsung 2018 UHD TV NU6900 User Manual, Samsung 2018 UHD TV NU7100 User Manual, and Samsung 2017 LED Smart TV M4500 User Manual

Product(s): This source is associated with more than one product. Refer to Newgle for more information about the product(s) offered for your coach's model year.

Samsung Air TV Programming

This article provides the basic programming instructions for Samsung Air TV.

1. If there is no signal after turning on the television, push the Home button on the remote.

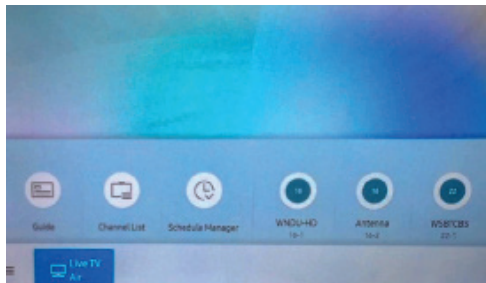

2. Use the left arrows until "Settings" appears on screen. Push "Select."

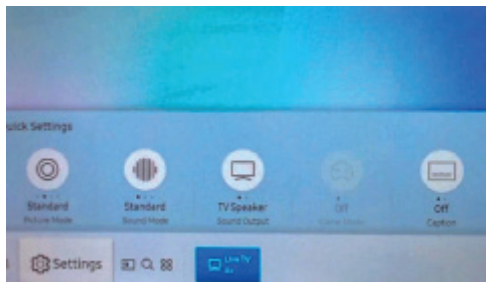

3. Scroll down to "Broadcasting," and push "Select."

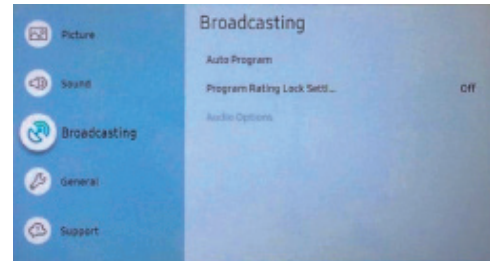

4. When "Auto Program" is highlighted, push "Select."

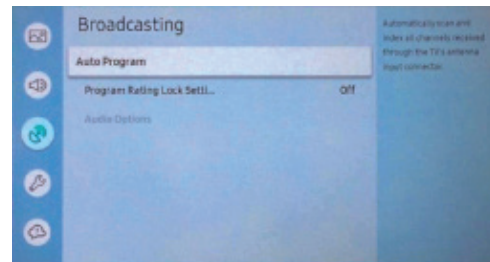

5. Highlight "Start," and push "Select." The TV will search for local channels and store them.

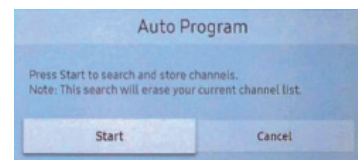

⚠ NOTICE

These steps will need to be completed each time the coach is moved to a new location.

Skyworth LED HD TV/DVD Combo Operation (Model: SLC-1921A)

This article provides basic operation instructions for a Skyworth LED HD TV/DVD Combo (Model: SLC-1921A).

Controls

1. **SPEAKER**
2. **POWER INDICATOR**
 - Green: In power on mode.
 - Red: In standby mode.
3. **REMOTE CONTROL SENSOR**
4. **SOURCE:** Change and select the desired mode (TV, AV, Component, DVD, HDMI, PC, USB)
5. **MENU:** Press to see an on-screen menu of your TV's features.
6. **CH +/- :** Press to change channels. In the on-screen menu, use the CH +/- buttons as up/down arrow buttons.
7. **VOL +/- :** Press to increase or decrease the volume. In the on-screen menu, use the VOL +/- buttons as left/right arrow buttons.
8. **POWER (STANDBY):** Press this button to turn the TV on or off.
9. **PLAY/PAUSE (▶||):** After you load a disc, press ▶|| to play the disc, and press ▶|| twice to pause.
10. **EJECT (▲):** Press the Eject button when the power is on to eject the disk. Press it again to load the disc automatically.

Remote Control

- POWER:** Press this button to turn the TV on or into standby mode.
- MUTE:** Press this button to mute the sound.
- SLEEP:** Press this button to set the sleep timer. The sleep timer values are: OFF, 5, 10, 15, 30, 45, 60, 90, 120, 180, or 240 minutes.
- OSD:** Press this button once to show main playback information on TV screen and press it again to show playback time. Press this button at the fifth time and then the display will be cancelled.
- SOUND:** Press this button to select desired sound mode.
- PICTURE:** Press this button select desired picture mode.
- RECALL:** This button is used to return to the previous channel. Go To: Press this button to go to desired position; the player provides three search modes:

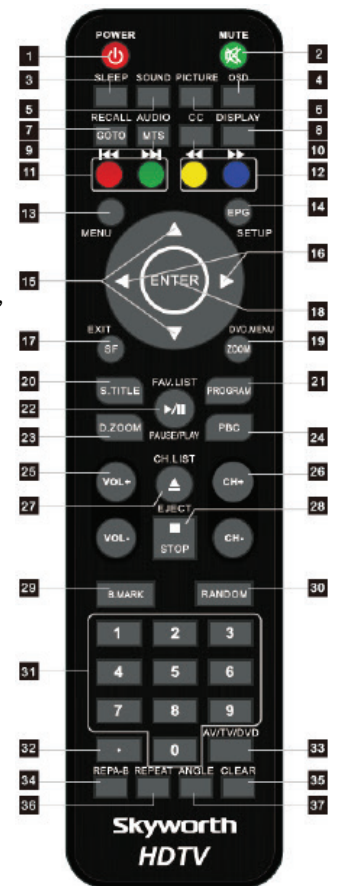

When the above items are showed on LED screen, you can input number to locate desired selector, then press PLAY to commence play. The number you input is invalid if it is beyond the track's capacity.

- DISPLAY:** Press this button to display the information on current input.

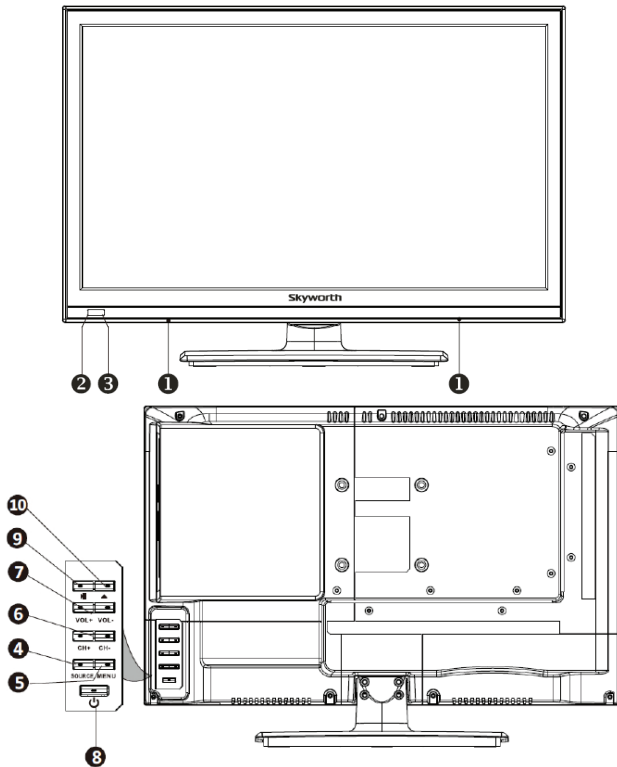

Input Options

- EARPHONE:** Connect a set of headphones for private listening.
- POWER (DC 12V) INPUT**
- HDMI:** Connect a device with a HDMI output.
- VGA/PC IN:** Connect your PC.
- PC AUDIO:** Audio input for external devices.
- COMPOSITE VIDEO:** Video input for external devices, such as a camcorder or VCR.
- COMPONENT:** Connect Component video.
- L/R AUDIO OUTPUT:** Audio outputs for external devices.
- RF:** Connect to an antenna or cable NTSC & ATSC.
- COAXIAL:** Connect to a Digital Audio device.
- USB:** Service port.

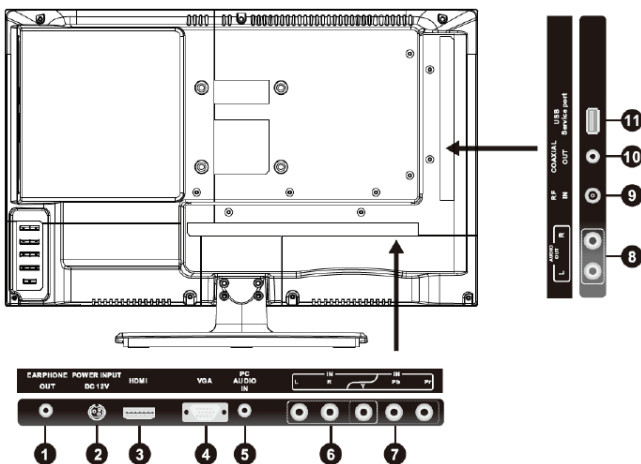

1. **AUDIO:** When playing DVD, press this button to change the audio language from the one selected at the initial settings to a different language, if available. **MTS:** When stereo program is received, press this button to switch sound system between mono and stereo. When SAP program is received, press this button to switch sound system between mono and SAP. When stereo and SAP program is received, press this button to switch among mono, stereo, and SAP.
2. **CC:** Press to turn ON/OFF closed captions.
3. **PREV/NEXT (◀◀ / ▶▶):** Press these buttons to go to the previous/next chapter (DVD). When playing CD disc, press ◀◀ button twice to select previous song.
4. **FR/FF (◀◀ / ▶▶):** These buttons allow skipping ahead/back at 5-level speeds. Press the Play button to return to normal playback.
5. **MENU:** Press this button to enter the menu mode for various optional adjustable settings or quit from current menu.
6. **ELECTRONIC PROGRAM GUIDE (EPG):** Press this button to call up the Electronic Program Guide. **Setup Button:** Press this button to get the setup menu you can select the desired settings.
7. **UP/DOWN (▲ / ▼):** Press these buttons to select the desired items in the menu.
8. **LEFT/RIGHT (◀ / ▶):** Press these buttons to select the desired items in the menu, or enter the selected.
9. **EXIT:** Press this button to escape from the current operation. **SF button:** Press this button to play the disc slow Forward.
10. **ENTER:** Press this button to enter the selected item.
11. **ZOOM:** Press this button to Zoom pictures. **DVD Menu:** If playing some DVD discs, press this button back to root menu screen. If playing DVD, you can use the function of MENU, PROGRAM, and RANDOM.
12. **S. TITLE:** Press this button you can change the subtitle language from the one selected at the initial settings to a different language if available.
13. **PROGRAM (PROG):** When you want to play only partial tracks/chapters of a disc “DVD” or to arrange the tracks/chapters playback order, you need to program the following.
 - Press PROGRAM button, then PROGRAM will appear on TV screen.
 - Press the track number in the order you want. For example, if the track numbers you want to play are 1, 3, and 8, just input in the order of 1-3-8. You can press the CLEAR button to cancel and input again if you miss input track numbers. Now you can press the “four-directional arrow button” and “OK” button to select “START” option and enjoy the desired tracks.
14. **FAVORITE LIST (FAV.LIST):** Press this button to start playback. Press this button again to pause playback.
15. **D.ZOOM:** Press this button during normal zoom in or zoom out playback mode. This player can magnify a picture at three levels. Press this button to magnify picture and use the “four-directional arrow” button to select desired part of the zoomed picture.
16. **PBC:** Press this button to return to the menu of the disc and play the disc from the first track.
17. **VOL +/- :** Press these buttons to increase or decrease the volume.
18. **CH+ / CH- :** Press these buttons to select channels in ascending or descending order.
19. **CH.LIST:** Press this button to display the channel list in TV mode.
20. **STOP (■):** When this button is pressed once, the unit records the stopped point from where playback will resume (resume function) if PLAY is pressed afterwards. But if STOP button is pressed again instead of the PLAY button, there will be no resume function.
21. **B.MARK:** When playing DVD disc, press this key to mark the place where you want to replay again.
22. **RANDOM (DVD ONLY):** Random mode allows you to play tracks randomly by pressing this button. Pressing again will cancel random playback.
23. **NUMBER (0-9):** Enter digits for channel selection or password setting.
24. **BLACK DOT:** For sub-channel selection.
25. **AV/TV/DVD:** Press this button to display the input source. Using UP/DOWN button to select and RIGHT or ENTER button to confirm.
26. **A-B REPEAT (REP A-B):** You can repeatedly play a given portion by operating as follows:
 - Press this button once to define the portion head (start).
 - Press this button again to define the portion toe (end).
 - Then the portion will be played repeatedly.
 - Press this button again to return to normal playback.
27. **CLEAR:** Press this button to cancel the numbers you input, just like an eraser.
28. **REPEAT:** Press this button to repeatedly play a chapter (DVD). You can repeatedly play a title (DVD). You can also repeatedly play the whole disc (DVD) and cancel the repeat function.
29. **ANGLE:** Some DVDs contain several scenes taken at the same time in different angles. Press this key to select a different angle (if the disc supports this function).

⚠ NOTICE

If an universal remote is used to control this TV, please program the universal remote using the Philips code.

Basic Operation

TURNING THE TV ON OR OFF

1. After attaching cable to either an antenna or a cable service, insert the power cord plug into a polarize AC outlet.
2. Press the POWER button on the LED TV.
3. The normal picture will be displayed on the screen after six seconds. If no signal, "No Signal" will display on the screen.
4. If temporary POWER of is required, press the POWER button on the LED TV.
5. If you want to completely switch off the power for this unit, unplug the power cord plug.
6. After switching off the unit, you should turn on the TV again at least five seconds later.

STATUS INDICATION LAMP

1. Green: In power on mode.
2. Red: In standby mode.

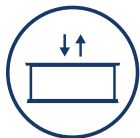

Television Lifts

Television Lift Operation via KIB Touchscreen

This article provides basic operation instructions for a television lift (televator) via a KIB touchscreen.

Operation

On some coaches, the TV lift controls are integrated into the KIB touchscreen switches (if equipped) and is labeled TV LIFT UP or TV LIFT DOWN. The touchscreen buttons will turn red while active and grey while not active.

1. From the Home Menu, press the Systems button.
2. Press and release the TV Lift Up button to raise the TV.
3. Press and release the TV Lift Down button to lower the TV.
4. The lift will continue in the selected direction until it reaches the end of travel. If you need to stop it at any time during the travel process, press the switch again in either direction.

⚠ NOTICE

Televator control switches and touchscreen buttons should be pressed and immediately released. Do not continue to hold the UP or DOWN switch or button, as this may cause the television lift to enter into programming mode.

Note: If programming mode is reached, refer to the re-calibration article in Newgle for more information.

AUTO POWER OFF

If there is no signal input in any mode, the TV will automatically access the standby state after approximately 15 minutes.

MEMORY BEFORE TURNING TV OFF

The settings of picture and the preset channels will be memorized at turning off the unit. When it is started up again, the unit will work according to the mode set before being turned off.

DVD Operation

1. Press the Eject (▲) button on the side panel or on the remote.
2. After placing a disc in the disc tray, press the ▶|| button to play the disk, and press the ▶|| button twice to pause the disk.

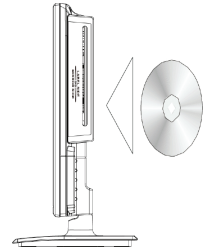

Source(s): Skyworth LED HD TV/DVD Combo User's Manual
Product(s): Skyworth 19" LED HDT TV/DVD Combo (Model: SLC-1921A-3S, Newmar Part Number: 145572)

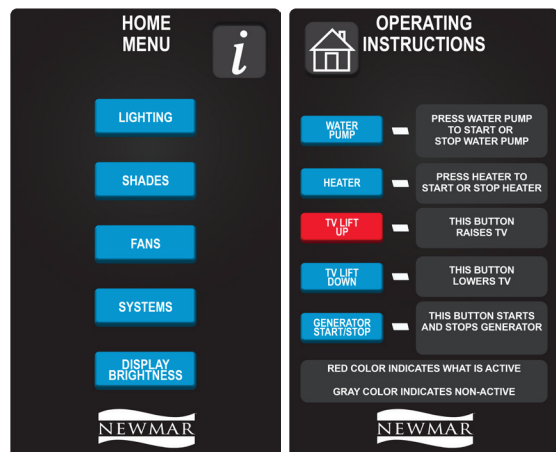

Televator During Travel

⚠ IMPORTANT

Lower the television lift completely for travel to prevent damage to the television and surrounding equipment.



Television Lift Operation via SilverLeaf HMS710

This article provides basic operation instructions for a television lift (televator) via the SilverLeaf HMS710 installed in coaches beginning in 2023.

Operation

On select coaches equipped with the SilverLeaf system, the control for the televator can be accessed by pressing the Lights/Shades or Shades/TV Lift button on the Home screen.



Press the Lights/Shades or Shades/TV Lift button to display the television lift (televator) controls. This button will not appear on coaches without a television lift.

1. Press the UP button to raise the TV.
2. Press the DOWN button to lower the TV.
3. If the lift needs to be stopped in a position other than up or down position, press the button again when the lift has reached the desired position.

Televator During Travel

⚠ IMPORTANT

Lower the television lift completely for travel to prevent damage to the television and surrounding equipment.

**Lower TV
while coach
is in motion**

⚠ NOTICE

This feature is not available on all coaches equipped with SilverLeaf.



EXTERIOR

This chapter provides information regarding the coach's exterior components, such as awnings, compartments, doors, steps, and the overall exterior construction of the coach. If applicable to the model, this chapter also contains information for components installed in handicap-accessible coaches and toy haulers.

IMPORTANT

Any of the following quick start instructions provided by Newmar should not take the place of the manufacturer's complete documentation. Refer to Newgle for more information about exterior components offered for your coach's model year.



Air Horns

Air horns may be installed on your coach, in addition to the horn installed on the chassis. Air horns on Newmar products may be located on the roof or under the front cap depending on year, and model.

Class A Air Horn Operation

This article provides basic operation instructions for an Air Horn installed on class A coaches. This information is not specific to any coach model or chassis manufacturer.

Generally, the driver can push in the center of the steering wheel (or the designated horn button) to operate the standard electric chassis horn, which is similar to the type of horn installed on most passenger cars and trucks. In addition, air horns are also standard (or optional) on many coach models and are installed at the factory during the production process. When equipped, the air horns may be mounted on the roof or under the front cap.

1. With the Air Horn Switch turned on and adequate air pressure in the air tanks, press the horn icon on the steering wheel to sound the air horn. Some coach models may require the ignition switch to be active for horn operation.
2. With the Air Horn Switch turned off, press the horn icon on the steering wheel to sound the standard city horn.

Air Horn Switch

If the air horns were factory-installed, there should be a horn selector switch located in the driver cockpit area (the exact location on the dash or driver console may vary). The Air Horn Switch allows the driver to choose between the air horn or the standard city horn.

Normally, the air horn and the electric chassis horn do not blow at the same time, but instead, only blows the horn that is selected at the time of activation. When the air horn is selected, the air solenoid located under the front hood or in the front driver side compartment is activated when the horn button is pressed on the steering wheel, which subsequently opens the air valve and supplies air to the horn.

The Air Horn Switch may be located in one of various locations based on coach model and year, but will always be within the driver's reach.



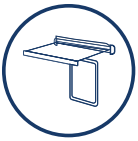

Awnings

Awnings are a standard feature on your coach. Newmar offers a variety of brands and types of awnings, depending on the year and model of your coach, as well as the available options that were selected at the time of your coach’s manufacture. Select models may feature slideout toppers, entrance door, and/or window awnings.

Awning and Slideout Topper Overview

This article provides a brief operational and maintenance overview of the awnings and slideout toppers.

Slideout Toppers

Slideout toppers operate as the slideouts are extended and retracted. Check the slideout topper for debris (leaves, branches, ice, snow, etc.) prior to retracting the slideout.

⚠ CAUTION

Slideout toppers should be retracted when snow, heavy rain, wind, and severe weather conditions are expected. Never leave slideout toppers open or unattended during severe weather and/or accumulating rain.

Awnings



Awnings are a standard feature on your coach. Newmar offers a variety of brands and types of awnings, depending on the year and model of your coach, as well as the available options that were selected at the time of your coach’s manufacture. Select models may feature entrance door, window awnings, and/or patio awnings.

The patio awning is the larger-sized awning on the coach and is the main awning. These awnings connect at or near the roof, providing shade and light rain protection on the passenger side of the coach. Awnings with LED strips may also provide lighting when desired.

The powered patio, window, and door awnings (if equipped) on your coach can be operated with ease using the appropriate switch(es) to extend or retract the awnings as desired.

The switch is typically located in the overhead control panel. If they are not at this location, check above the passenger window, as it may be hidden by the window shade. Some coach awnings may also operate via remote control or the SilverLeaf touchscreen (if equipped).

⚠ CAUTION

Awnings should be retracted during accumulating rains. Pooling water on the awning can result in damage to the awning hardware and/or fabric.

⚠ CAUTION

Awnings should be retracted when snow, heavy rain, wind, and severe weather conditions are expected. Never leave awnings open or unattended during severe weather and/or accumulating rain.

⚠ IMPORTANT

Prior to extending any of your coach awnings, check for any obstructions that may prevent the awnings from deploying properly. Inspect the area around your unit where the awning will extend to ensure proper clearance.

⚠ CAUTION

Awnings should be retracted during accumulating rains. Pooling water on the awning can result in damage to the awning hardware and/or fabric.

NI-132

⚠ NOTICE

Damage to your awnings as a result of weather is not covered by warranty.

Girard Awning Operation via Wall Switch and Remote (Model: G and Nova Series)

This article provides basic operation instructions for a Girard Awning via Wall Switch and Remote (Model: G and Nova Series).

Before using your awning make sure that all of your electrical circuits are operating correctly. Recreational Vehicles can generate AC power from three separate sources. The electrical system transfer switch in your vehicle will select power for the awning as follows:

1. Shore Power – if connected;
2. Generator Power – if the generator is running;
3. Inverter Power – batteries must be charged for inverter operation.

⚠ CAUTION

Never leave awning(s) extended without AC power available to retract awning(s) via the motion/wind sensor.

How To Operate The Awnings

⚠ CAUTION

Never leave the awning open and unattended. All awnings must be closed prior to moving the vehicle for any reason. As an extra safety precaution, check to make sure every awning is fully closed. Before using your awning, ensure that the surrounding area is free of obstructions (trees, walls, pillars, posts, other vehicles, etc.). Damage caused by failure to comply with these instructions is not covered by warranty.

⚠ IMPORTANT

Girard awnings may be operated in light wind and rain conditions. When periods of heavy rain and/or high wind are expected, the awning must be closed. Damage caused by wind and rain is not covered by warranty.

The main patio awnings are operated by a handheld remote switch or a switch mounted in the overhead cabinets or on the wall in the passenger cockpit area. The exact location may vary by coach model and year. Most switches are remote-battery operated. Girard recommends replacing the batteries every year.



CHANNEL + / - BUTTONS

To operate the awnings, change the channel until the visual indicator displays next to the channel you wish to select:

- Channel “1” selects the front main awning
- Channel “2” selects the rear main awning
- Channel “0” OR “All” selects all active channels for Girard awnings at the same time.

IN/OUT/STOP BUTTONS

Use the “In/Out” or “Stop” buttons to operate the awning after the desired channel(s) are selected.

- Press and release the “Out” button to extend the awning(s).
- Press and release the “In” button to retract the awning(s).
- Press the “Stop” button during extension or retraction to stop the awning(s) in the desired position between full extension and full retraction.

LOCK/UNLOCK BUTTONS

- Pressing and holding the lock button for 10 seconds will lock the switch panel or the handheld remote control individually. While in lock mode, the display will show the letter “L,” and the other buttons will be inoperative. This will prevent accidental operation while locked.
- To unlock, press and hold the the unlock button for 10 seconds.

Note: If the awnings are in the extended position and the remote is locked, the awning will still operate via the motion/wind sensor as long as AC power is present to operate the awning(s).

LIGHT BULB BUTTON

To turn on or off the awning lights, press the “Light Bulb” button. The button alternates the lights between on and off.

⚠ NOTICE

The awnings will not extend when the park brake is released. However, the main awnings will retract when the park brake is released if they are still being supplied with 120 volt power. All other Girard door and window awnings (if equipped) will lose power and will not operate when the park brake is released.

Source(s): Girard Multi-Channel Wall Switch (98GC782) Overview

Product(s): Girard Nova Series Awning (Model: NOVA, Newmar Part Number: NovaAwning)

Source(s): G-2000 Patio Awning G-1500 Door Awning Installation, Operation, Adjustment, and Repair (REV. 01272016)

Product(s): Girard G Series Awning (Model: G2000, Newmar Part Number: G2000)



Compartments

Storage compartments are located on the exterior sides of your unit. These compartments provide additional space for your belongings while you are traveling. Select coach models feature optional manual slide trays and standard lighting, while others may feature compartments complete with power slide trays, dual side access, and automatic LED lighting throughout the storage area.



⚠ IMPORTANT
Before traveling, perform a pre-trip inspection that includes checking each baggage door to ensure each one is latched and locked securely.

⚠ CAUTION
Use caution when packing the storage areas. Do not pack items around water heaters, refrigerators, furnaces, hydronic heating units, or any other heat-producing appliances.

Electric Compartment Locks Overview

This article provides an operational overview for locking and unlocking electric compartment door locks.

Operation

The Cargo **Lock/Unlock Switch** operates the cargo door locks on all compartments with electric locks from one convenient location. This switch is located on the passenger console. To unlock the doors, press the switch to the unlock position (shown as an unlocked padlock icon). To lock the doors, press the switch to the locked position (shown as a locked padlock icon).



Doors, Handles, and Chimes

This article provides basic information about the doors, handles, and chimes installed in a Newmar coach. The front entrance door is equipped with a dead bolt lock for added security, and select coach models may have a power flush step well cover.

For your safety and convenience, all current models feature a grab handle at the entrance door to assist you in entering and exiting the coach. Select models may incorporate the keyless entry system, and many have a doorbell button integrated into the grab handle as well.

When the door is opened fully, the door has a “door check” feature that will automatically hold the door open. To close the door, simply pull to release the detent, then close and latch the door. Center entry doors may incorporate a gas strut to hold the door open.

Entry and Screen Door Overview

This article provides an operational overview of the entry and screen door.

Deadbolt Operation

1. From the inside of the coach, operate the dead bolt by first making sure the door is closed securely in the second stage latch. Rotate the dead bolt lever clockwise.
2. From the outside of the coach, use the key and rotate it counter-clockwise to engage the dead bolt.

⚠ NOTICE
This information is generic in nature and may not be specific to your exact coach model and/or year.

- To lock the door without using the deadbolt, press and hold the number one key on the keyless entry touch pad (if equipped).
- Flip the red lever before shutting the door, and use the key fob (if equipped).

Entry Screen Door Operation

- Store the entry screen door's top screen for travel by pulling down in the center and unlatching the two hooks at the bottom.
- Allow the screen to retract gently while continuing to hold the bottom of screen.
- When not traveling, pull the screen down in the center, and latch the screen using the hooks at the bottom.



NOTICE

Do not extend the deadbolt before closing the door, as damage may occur.

Entry Door Lock Switch Overview

This article provides an overview about the Entry Door Lock Switch.

The entry door lock switch is located on the dash and will lock or unlock the entry door. This switch also allows you to control the cargo locks from inside the coach without arming the security alarm. The entrance door can also be manually unlocked and opened from the inside without the alarm sounding.

- Flip the switch down to lock the doors.
- Flip the switch up to unlock the doors.

Select coaches may be equipped to automatically lock the front entry door when the park brake is released for travel or unlock the front entry door when the park brake is engaged.



Entrance Steps

Your coach may be equipped with electric entrance door steps. Select coach models may be equipped with hydraulic steps. Both types of steps automatically extend when the entrance door is opened and retract when the entrance door is closed.

Electric Exterior Entrance Steps Overview

This article provides an operational overview of the electric exterior entrance steps installed on select coach models.

Operation

With the **Entrance Step switch** in the overhead cabinet flipped in the operational position, the entrance step will operate each time the entrance door is opened or closed.

If the door is closed when the **Entrance Step switch** is flipped opposite of the operational position, the step will extend one time. If the door is open when the Entrance Step switch is flipped opposite of the operational position, the step will stay extended.

The step will remain in the extended position unless the ignition signal is activated, which overrides the **Entrance Step switch**. In this case, the step will extend or retract when the door is opened or closed.

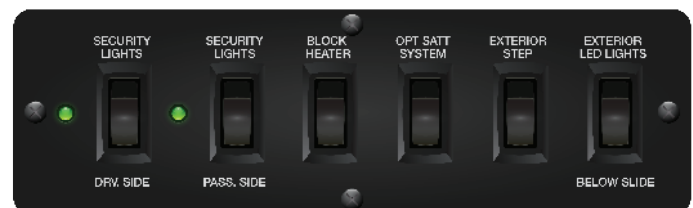

KwikEE Electric Entrance Step Operation (Model: 42 Series)

This article provides basic operation instructions for a KwikEE Electric Entrance Step (Model: 42 Series).

Operation

⚠ WARNING

If the vehicle is driven with the step in the extended position, there is the possibility of causing major damage to both the step and the coach.

1. Close the door. The step should retract and lock in the “in” position.
2. Open the door. The step should extend and lock in the “out” position.
3. If your step is equipped with an override switch, turn it on. The step should remain in the extended position when the door is closed.

4. With the override switch on, the step extended, and the entrance door closed, turn on the vehicle ignition. The ignition override system will go into effect and the step will automatically retract.
5. Turn the vehicle ignition off and open the door. The step will extend and lock in the “out” position. This is the “Auto-Extend” feature.

When the vehicle ignition is on, the step will always activate with the door movement, regardless of the override switch position.

Source(s): KwikEE by Lipper Components 42 Series Step #842 Owner's Manual

Product(s): This source is associated with more than one product. Refer to Newgle for more information about the product(s) offered for your coach's model year.

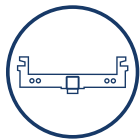

Hitches and Towing Components

Your motorhome is equipped with a hitch and tow plug, as it is designed for towing light loads. Your hitch may provide you with the capability of towing your car or trailer while traveling. A wiring harness or pigtail is needed to connect tail lights, brake lights, turn lights, etc. of the towed vehicle with that of the coach. Some coach models feature rear docking lights to assist with tow vehicle hookup at night.

FOR MORE INFORMATION

Refer to the chassis or product manufacturer's owner's manual and links in Newgle to learn more about your coach's hitch and towing components.

Hitches and Towing Overview

Your motorhome is equipped with a hitch and tow plug, as it is designed for towing light loads. Your hitch may provide you with the capability of towing your car or trailer while traveling. A wiring harness or pigtail is needed to connect tail lights, brake lights, turn lights, etc. of the towed vehicle with that of the coach. Some coach models feature rear docking lights to assist with tow vehicle hookup at night.

Prior To Towing

Prior to towing, inspect all towing connections, including the hitch mounting bolts for unusual wear or corrosion. Check the mounting flanges for any deformation, as well as the hitch welds for any cracks, signs of movement, or fatigue in the hitch assembly. Safe and satisfactory performance of the towing system depends on the type of towing equipment connected to the hitch receiver. The assembled length of the drawbar/towing system used should be kept to a minimum. Do not exceed the rated capacities of the hitch or the components used to attach the towed vehicle or trailer.

⚠ IMPORTANT

Newmar is not responsible for damage or failure of the hitch receiver caused by the use of excessively long drawbars or other styles of drawbars that create leverage loads on the hitch receiver beyond its designed capabilities.

⚠ WARNING

Do NOT cut, drill, weld, or modify hitch.

Towing Capacity

The total weight of the motorhome and any vehicle towed must not exceed the GCWR (Gross Combined Weight Rating). When planning to tow, approaching the GVWR (Gross Vehicle Weight Rating) may reduce the motorhome's towing capacity. When weighing the motorhome, be sure to take passenger locations into consideration. The towed vehicles must have adequate active brakes. Contact your state Department of Transportation or your local Newmar dealer for your state requirements.



IMPORTANT

The hitch is typically supplied and installed by the chassis manufacturer, and it may be necessary to contact them directly for weight ratings and towing recommendations. Some information may also be available on a data label adhered near the hitch.

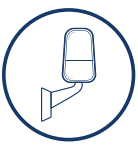

Mirrors

Your coach may be equipped with convex remote-controlled two-part exterior rear view mirrors. The top portion of the mirror is flat, providing conventional reflected views down the sides of the RV, while the bottom portion is convex to provide an expanded view, helping to eliminate blind spots. These mirrors may also contain heating elements to defog, defrost, or de-ice the mirror glass during cold weather operation. Some mirrors can be operated via remote control.

Exterior Mirror Multi-Directional Adjustment and Heat Toggle Switch Operation

This article provides basic operation and adjustment instructions for an exterior mirror.

Overview

Your coach may be equipped with convex remote-controlled two-part exterior rear view mirrors. The top portion of the mirror is flat, providing conventional reflected views down the sides of the RV, while the bottom portion is convex to provide an expanded view, helping to eliminate blind spots. These mirrors may also contain heating elements to defog, defrost, or de-ice the mirror glass during cold weather operation.



Operation

Some mirrors can be operated via remote control. These mirrors are adjusted by using the multi-directional switches located on the driver's door (optional on some models) or console. Make sure the seat is positioned for proper vehicle control, and then adjust the mirrors for maximum rear visibility prior to driving.

ADJUSTMENT CONTROL

The Mirror Control switch operates the electric portion of the mirror and adjusts the mirror up, down, back, and forth. To select which mirror to adjust, flip the selector to the left or right position. Move the selector to the center position to obtain the best view and make the directional arrows inactive. The adjustment control moves the top half of both mirrors. The bottom half of the mirror is convex and is adjusted manually.

HEAT

The red switch located near the mirror adjustment control operates the mirror heat (if equipped). The ignition switch must be on for the mirror heat switch to operate.

1. To turn the mirror heat on, turn the switch to the "ON" position. The light will illuminate on the switch when the mirror heat is operating.
2. To turn the mirror heat off, turn the switch to the "OFF" position. The light on the switch will turn off when the mirror heat is no longer operating.

IMPORTANT

Objects viewed in the convex mirrors are closer than they appear.



Optional Accessories

Flagpole Assembly Overview

This provides information about the flagpole option available on some coach models (Option # R045).

Assembly Components

The flagpole assembly (Newmar part # 143894 or 138708) should handle any standard 1-inch flagpole that may mount on the side of a house. If the coach is equipped with the optional flagpole mount (Newmar option # R045, Newmar part # 138682 and 138683), it is typically located on the front of the coach just in front of the entrance door. The flag assembly may be shipped from the factory in a kitchen drawer.

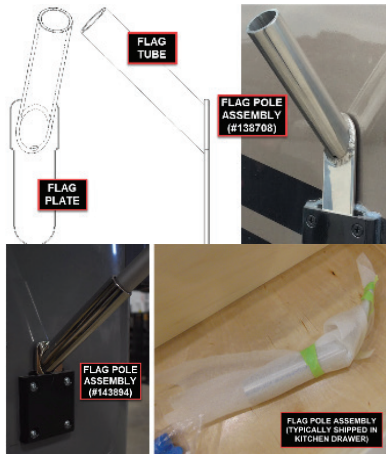

⚠ WARNING

When installing a flagpole assembly, ensure you have proper clearance away from overhead electrical lines or other obstructions.

⚠ DANGER

Do not leave flagpole assembly in mounting bracket while vehicle is in motion.

Assembly Installation and Removal

The mount's slot allows the angled flag assembly to easily be installed while displaying a flag and easily removed for travel. To display a flag, simply slide the assembly down into the mounting bracket, then install the flagpole (not provided by Newmar). To remove the flag and assembly, reverse the order of installation. For coach owners who wish to have a flagpole assembly installed on their coach, contact the Newmar Parts Department to order the proper assembly components. Newmar recommends having the mount installed by an Authorized Service Center.

Flagpole Safety

⚠ CAUTION

The flagpole assembly is not intended to be used in high wind conditions.



Paint, Roof, and Siding

This article provides a basic overview and maintenance of the roof and sidewalls.

Roof and Sidewalls Overview and Maintenance

Sidewalls

Newmar RV sidewalls are designed with structure to make them more rigid and dependable. By building aluminum frames with studs 16 inches on center, your sidewalls and roof will form a strong, lightweight, integrated structure so you can enjoy superior insulation. The sidewalls and end caps of your coach are constructed of smooth fiberglass, which is features an automotive style "Clear-Coat / Color Coat" painted finish.

SIDEWALLS MAINTENANCE

This article provides a basic overview and maintenance of the roof and sidewalls. Clean any unpainted fiberglass material with a mild cleanser and warm water. Use only soft cloths. Using stiff bristle brushes may cause scratches in the fiberglass surface.

⚠ IMPORTANT

Newmar is not responsible for weathering/oxidation of gel-coated surfaces.

EXTERIOR PAINT MAINTENANCE

For cleaning and waxing instructions and recommended products, refer to the Miscellaneous Care and Maintenance section in Newgle. Paint codes are typically posted on the back side of one of the upper kitchen cabinet doors.

Roof

This unit is manufactured with a 7mm decking material covered with fiberglass or rubber membrane. Proper care and routine maintenance of your roof is necessary for trouble-free performance. Frequent inspection (at least annually) of roof drains, seams, and joints should be performed by an Newmar Authorized Service Center.

ROOF MAINTENANCE

Regular cleaning and maintenance is essential to insuring a long, trouble-free life. Before cleaning, it is important that you inspect the sealants and gaskets used to seal components to the roof structure to be certain there is no leakage during the cleaning process. Any cracks or voids in the sealants and seals **MUST** be repaired prior to spraying the roof with water. Extreme caution should be used when inspecting or cleaning the roof.

NOTE FROM NEWMAR

For information about cleaning your roof drains and gutters, refer to the Roof Drains article in Newgle.

⚠ WARNING

It is recommended that access, cleaning, and maintenance be conducted by a qualified professional at your local dealership. Use caution if working on top of your vehicle. The wet roof surface is extremely slippery.

If inspection and/or maintenance becomes necessary, stay on the main roof area. Do not walk or stand on the raised portions of the roof or the gutter rail area (if applicable). Do not exceed 300 pounds on the roof.

⚠ NOTICE

Do not place items on the roof for transportation. The roof was not designed to support the transportation of luggage or other items.

Diesel Pusher Roof Drains and Gutter Maintenance

This article provides cleaning recommendations and instructions for roof drains and gutters on diesel pusher coaches. Not all years and/or models of diesel pushers are equipped with roof drains.

Note: This started as a high line feature around 2007 and has been implemented in additional coach models throughout the years (King Aire, Essex, London Aire, Mountain Aire, New Aire, Dutch Star, and Ventana diesel pushers). The feature was added as the coaches began including roof-mounted Girard awnings with integrated gutter rails at the edge of the roof and bezels to match the awnings on the front and rear caps.

For diesel pusher coaches that are equipped with roof drains, it is important to make sure the roof drain catch basin strainers are cleaned and kept free of debris. There are four (4) of them, and they are located at the front and rear ends of the roof gutters, on both the left and right sides. They may be covered by the roof-mounted awnings.

The drains can be blown out using compressed air (approximately 60 PSI) from the drain pipes found under the front and rear caps. There are typically two drain pipes on the passenger side of the rear cap and one on each side of the front cap.



Exterior Paint Overview

We're passionate about paint. And we believe that the RV we create for you should be as beautiful as it is comfortable. Our coaches are more gorgeous than ever, with a sleek, stunning exterior showcased by all-new graphics and the exquisite Full-Paint Masterpiece™ Finish. Our goal is to create a perfect finish every time we paint a Newmar. This is how we do it:

- Between 12 and 16 gallons of paint are used on each model.
- Several types of primer are applied, followed by a base coat, color for graphics and a final, clear coat.
- We use materials of only the highest quality and integrity.
- Our technicians are among the most knowledgeable and highly experienced.
- The equipment and techniques we have created are among the most advanced.

We always ensure that each coat of paint lays flat and smooth to produce a stunning brilliance. That's how we can promise that your Newmar RV will offer you an exterior of the highest quality and durability.

For cleaning and waxing instructions and recommended products, refer to the Miscellaneous Care and Maintenance section in Newgle. Paint codes are typically posted on the back side of one of the upper kitchen cabinet doors. For more details about paint codes, refer to the “Coach - Paint Code Pages” section in NewPar, Newmar’s online parts catalog (Parts and Warranty Reference > Coach - Paint Code Pages > Coach Year > Coach Model > More Info).

Diamond Shield Paint Protection Use and Care Guidelines

This article provides basic care and maintenance guidelines for the Diamond Shield paint protection. Follow the use and care guidelines as outlined by Diamond Shield.

⚠ IMPORTANT

Once applied, refrain from washing for 48 hours, washing after that time presents no problems. Do NOT use harsh or abrasive cleaners or detergents.

Step 1: Wipe Regularly

Wiping bugs and road grime off your vehicle, with a wet soft cloth, as soon as you get a chance is essential to keeping your film looking great. This will also reduce the risk of staining and discoloration from bug acids, runoff stains, and road grime left on for an extended period. When done, apply 303 Aerospace Protectant!

Step 2: Wash Monthly

Washing monthly will give your film the deep clean it deserves and will ensure the film remains crystal clear. We recommend using Advanced RV & Auto Wash and a soft cotton or lambswool mitt to apply. Do not use any abrasive brushes, rags, cloths, or compounds. When you’re done, apply 303 Aerospace Protectant!

⚠ IMPORTANT

Do not use Rain-Ex products or bug and tar removers.

Step 3: Wax Quarterly

Waxing your film on a quarterly basis, or more, will add that extra layer of protection to your film. Keeping it waxed will prevent damage from bug acids and road grime, and allow the film to effortlessly be wiped clean. We recommend using Advanced RV & Auto Wax, a synthetic polymer cream wax designed specifically for Diamond Shield.

General Care Precautions

Several cleaning techniques and cleaning products should NEVER be used on the areas protected by Diamond Shield on your vehicle.

- Do not pressure wash.
- Do not use Rain-X products.
- Do not use any abrasive brushes, rags, cloths or compounds.

This general care list is not comprehensive. Please call Diamond Shield at 1-888-806-5862 before using any products not specifically listed on Diamond Shield’s website. Using unapproved sprays, cloths, or waxes may cause damage to the film, which may not be covered under warranty.



Windows and Windshields

The windows installed in your coach are either single or double pane tinted safety glass. Most current models offer sliding glass windows. A power window may be installed on the driver’s side on select models. Proper care and maintenance of your windows and windshield is critical to maintaining good visibility and safe operation of the coach.

How To Open and Close The Emergency Exit Windows

This article provides step-by-step instructions for opening and closing emergency exit windows and doors.

Hehr Egress Emergency Exit Window

Select Hehr windows have an opening window pane in the egress window for ventilation. This style of window can also be opened in the event of an emergency.





Hehr Double-Latched Emergency Exit Window



TO OPEN THE VENT:

1. Unclip and lower the arm.
2. Swing the arm 90 degrees, and push out on the arm until the red handle latches.

TO CLOSE THE VENT:

1. Unclip the red handle from the latch by lifting slightly while pushing outward.
2. Once the latch releases, pull the arm in until the window is closed.
3. Rotate the arm 90 degrees until it latches into the closed position.

IN THE EVENT OF AN EMERGENCY, OPEN THE WINDOW:

1. Remove the screen by pulling out on the red handle.
2. Push and release the lever from the locking hook.
3. Rotate the lever 90 degrees, and push it through the slot in the window frame.
4. Escape through the opening.

TO OPEN THE EMERGENCY EXIT DOUBLE LATCH STYLE WINDOW:

1. Flip both latches up to the open position.
2. Push out on the window.

TO CLOSE AND LATCH THE EMERGENCY EXIT DOUBLE LATCH STYLE WINDOW:

1. Pull the window shut while holding the window track with one hand.
2. With the other hand, rotate the latch up until it connects with the track on the window.
3. Press the front side down until it latches.
4. Repeat the steps for the second latch.

Fresco Flush Slide Driver Side Power Cockpit Window Operation

This article provides the operation instructions for a Fresco flush slide driver side power cockpit window.

The directional switch on the driver side console operates the Fresco power window.

1. With the ignition on, press and hold the switch in the up or down position to move the window in the desired direction.
2. Continue holding the switch until the desired window position is obtained. Then release the switch.
3. Pressing down on the switch opens the window by pulling the window in and sliding it forward.
4. Pressing up on the switch closes the window by sliding the window back and pushing the window out.



How To Prevent Window Condensation

This article provides a preventative overview of condensation on the inside of the windows and within the coach. Accumulation of condensation on surfaces within your unit occurs when warm, moist air contacts a cool surface. It is most evident on the inside of windows.

⚠ IMPORTANT

Since surface condensation within the coach cannot be controlled by the manufacturer, damage caused by condensation is not covered by your Newmar Limited Warranty.

Damage may occur to your unit if excessive condensation exists. This problem can be controlled by:

1. Slightly opening a window or roof vent to allow the moisture to escape from the unit.
2. A small dehumidifier is also very effective in removing moisture from the air.

Condensation levels are highest during times when a person is cooking or taking a shower in the unit, but these are not the only times condensation is present. Condensation can migrate through ceiling panels and saturate the fiberglass insulation in your ceiling cavity. This condition often causes the occupants to believe the recreational vehicle has a roof leak. Walls and ceiling panels may also become wet when the moisture accumulates on these surfaces.

⚠ IMPORTANT

Newmar Corporation does not recommend the use of any catalytic heaters.

Windshield Maintenance and Replacement

Proper care and maintenance of your windshield is critical to maintain good visibility and safe operation of the coach.

Care and Maintenance

Keeping your windshield clean will provide optimum visibility to view the road ahead. Should you encounter rock chips or cracks, have them fixed by an automotive glass professional immediately to avoid costly windshield replacement. If the crack spreads, replacement may be necessary.

Check the windshield washer fluid level prior to each trip, and top off the fluid reservoir as needed.

Windshield Replacement

When replacing a windshield, Newmar highly recommends purchasing the new windshield through the Newmar Parts department to ensure proper windshield fit. Customers and dealers have experienced many size and installation issues when attempting to use aftermarket windshields. If your windshield needs replaced, make sure that your dealer or glass replacement company purchases the replacement windshield directly from Newmar.

⚠ CAUTION

Do not operate the windshield wipers with damaged blades, as they may cause damage to the glass. Damage to glass by rocks, damaged wipers, or other foreign objects are not warrantable repairs.

Skylights Overview

This article provides basic information about the skylight installed in the coach.

For improved lighting and headroom, a skylight may also be installed in the bathroom over the shower. The opening provides additional light during daylight hours, and the skylight is tinted to provide privacy and reduce glare.

The skylight should be inspected with the roof and components, and the sealant should be maintained. Some sealants are not compatible with the skylight material. Newmar recommends using Surebond SB-140 butyl sealant around the skylight. Periodic cleaning using a mild detergent or cleaner specifically designed for plastics (such as Novus No. 1) is necessary; cleaning frequency may depend on the surrounding conditions while driving, parking, or storing the coach.

⚠ WARNING

It is recommended that access, cleaning, and maintenance be conducted by a qualified professional at your local dealership. Use caution if working on top of your vehicle. The wet roof surface is extremely slippery.





Wiper Systems

Wiper System Care and Maintenance

This article provides basic care and maintenance about the coach's wiper system, as well as information about wiper blade replacement.

Maintaining The Wiper Blades

Proper care and maintenance of your wiper blades is critical to maintain good visibility and safe operation of the coach. Clean the rubber element every time you fill your gas tank, and remove loose dirt and road grime from the windshield. When washing your coach, use a small amount of non-abrasive glass cleaner on a wet sponge to clean both the windshield and the rubber wiping elements. In colder climates, use an ice scraper to remove snow and ice. Using your wipers to de-ice your windshield can damage the blades, as well as the arm and wiper motor.

Streaking, chattering, and worn blades may be caused by dry rubber that has hardened and cracked. Streaking can also be caused by oil, tree sap, road tar, or other foreign substances on the blade rubber or windshield. Chattering sounds as the blade passes across the windshield are caused by the "deformity" or "curve" in the rubber that some wiper blades develop over time.

Worn, damaged, or split rubber around the wiping edge is generally caused by age and use, but may be due to the effects of the sun's ultraviolet rays on the rubber. Damage may also be caused by ice scrapers, automatic car washes, or vandalism. Damage to glass by rocks, damaged wipers, or other foreign objects are not warrantable repairs.

Replacing The Wiper Blades

WARNING

Replace your windshield wiper blades when they become worn or damaged. Worn or damaged wiper blades may cause damage to the windshield, as well as interfere with the driver's ability, possibly resulting in a crash leading to injury or death.

To inquire about replacement wiper blades or other components, refer to the NewPar (formerly ComNet) parts catalog or contact the parts department at 1-800-731-8300 (option #1). This will help ensure the proper wiper fit.

This page is intentionally blank.



HVAC

This chapter provides operational instructions for components related to dash and roof air conditioning, fans and ventilation, heating systems, and climate control.

⚠ IMPORTANT

Any of the following quick start instructions provided by Newmar should not take the place of the manufacturer's complete documentation. Refer to Newgle for more information about heating, ventilation, and air conditioning components offered for your coach's model year.



Air Conditioning and Heat, Dash

Dash Air Conditioning and Heat Controls and Settings

The article provides a basic overview for the dash air conditioning and heat controls and settings.

Overview

The dash air conditioning control panel enables the driver to control the temperature, volume, and direction of the air discharged from the heating/air conditioning system. Select coach models may have a driver and passenger control with a switch (labeled HVAC OVRD) that allows the driver to override the passenger controls.

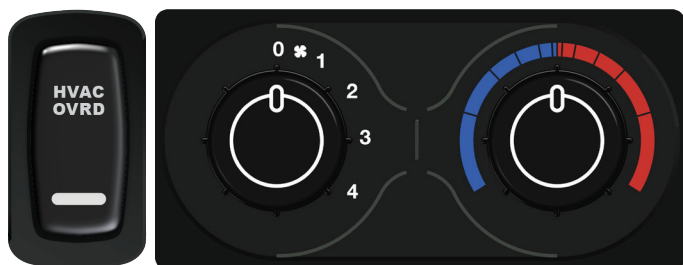

Controls and Settings



BLOWER SPEED

One of the best ways to control the temperature is by changing the speed of the blower. The blower knob (left of center) provides four speeds in any mode, except when the control is set to OFF.

TEMPERATURE CONTROL

The center knob controls the temperature of the discharged air. Turn the knob to the right (red area) for warmer air, and to the left (blue area) for cooler air.

MODE

To achieve the maximum comfort in your coach, the air must be directed where it is needed. The mode switch (right of center) gives the driver the ability to select where the air will flow. The air conditioning system is designed to operate in all modes except VENT, FLOOR, and OFF. This provides significant moisture, dust and pollen removal for enhanced passenger comfort.

⚠ IMPORTANT

If the mode knob is in any position other than OFF, the blower is always on a low speed unless a higher speed is selected.

MAX A/C OR A/C RECYCLE BUTTON

Air is drawn from the passenger compartment and is discharged and recirculated through the dash louvers. This position is used to provide maximum cooling, and is generally used during extremely hot weather conditions for initial cool-down periods. Because this mode does not allow fresh "outside" air into the passenger compartment, it may cause fogging of the windows, and/or stale air, when used for prolonged periods of time. Switch to A/C mode periodically if these conditions occur.

A/C OR SNOWFLAKE BUTTON

Outside/fresh air is drawn into the system and discharged through the dash louvers. These louvers can be adjusted for maximum comfort.

VENT

Outside air is drawn into the system and discharged through the dash louvers. For enhanced passenger comfort, upper-level ventilation air is also discharged through the defrost outlets. When outside ambient temperatures are below approximately 40° F, the A/C compressor may cycle rapidly. Use Vent mode instead of A/C in these temperature conditions to cool the interior air temperature.

⚠ IMPORTANT

For operational safety in the event of the loss of vacuum, the HVAC system is designed to discharge air through the defrost vents to provide continuous windshield defogging.

OFF

The blower motor does not operate in this mode. The fresh air inlet door closes, minimizing outside air infiltration into the vehicle.

BI-LEVEL

Outside air is drawn into the system and discharged through the dash louvers, floor, and defrost outlets. The A/C system operates in Bi-level mode.

FLOOR

Outside air is drawn into the system and discharged through the floor outlets. In some models, a small amount of air is directed to the windshield for defrost. The a/c system does not operate while in floor mode.

MIX

Outside air is drawn into the system and discharged through the floor and defrost outlets. The A/C system operates in Mix mode to provide windshield defogging.

DEFROST

Outside air is drawn into the system and discharged through the defrost outlets. The A/C system operates in Defrost mode to provide windshield defogging.



Air Conditioning and Heat, Roof

Roof Air Conditioning and Heat Overview

This article provides a brief overview of the roof air conditioning and heat pump, as well as filter maintenance. Keep your coach comfortable year around!

Your coach’s air conditioners can be operated using the Comfort Control thermostat, KIB V-Bus LCD touchscreen, or the appropriate SilverLeaf screen. For more detailed information about climate control, refer to the appropriate product page(s) and associated content in Newgle.

Some roof top air conditioners have the ability to work as a heat pump when desired to produce heat instead of cooling. These models are effective at producing heat at ambient temperatures (above approximately 40 degrees). If the temperature drops below the threshold, most controls will revert to the furnace or hydronic heating system to produce the necessary heat.

Most air conditioning systems have a two minute built-in time delay, so there may be a slight delay in the operation of the air conditioner after the thermostat is set.



Filter Maintenance

On some coach models, grills with filters may be located behind decorative covers on the ceiling.

1. Remove the vent cover grill from the return air duct or the grill from the air conditioner ceiling assembly.
2. Remove the filter.
3. Wash, rinse, and dry the filter. If the filter does not come clean, or is damaged, replace it with a new filter. Do not substitute other types of filters, as this may restrict air flow and cause other issues. Do not operate the air conditioners without filters.
4. Reinstall the filter on the cover, and place it back into the vent.
5. Repeat the process for each return air vent.

For more information about accessing filters underneath decorative covers, refer to other Newgle articles (How to Access and Clean Air Conditioner Filters with... louvered wood covers, friction, mechanical, or magnetic latch covers).



Fans and Ventilation

Vents operating on 12 volt power may be installed in your coach kitchen and bathroom. Depending on your vent setup, they may be controlled by a switch directly on the vent assembly or the switches located on the wall. Dash fans may also be installed on or in the front overhead cabinet and aid in windshield defrosting and air circulation in the cockpit area of the coach.

Urea-formaldehyde Safety Guidelines

This article provides information about proper ventilation to prevent issues such as condensation and the release of urea-formaldehyde from coach products. Depending on your vent setup, they may be controlled by a switch directly on the vent assembly or the switches located on the wall. Dash fans may also be installed on or in the front overhead cabinet and aid in windshield defrosting and air circulation in the cockpit area of the coach.

Urea-formaldehyde is used in the production of particle board, hardwood plywood, and most paneling. Urea-formaldehyde resin may release formaldehyde vapors into the air, which may cause headaches, and in some people, eye, nose and throat irritation. Formaldehyde may intensify some allergies or upper respiratory problems like asthma.

Providing proper ventilation as needed by operating the power roof vents and opening windows should reduce the risk of such problems.

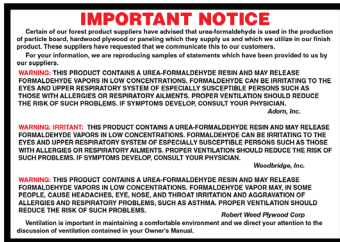

NOTICE

This vehicle is TSCA TITLE VI COMPLIANT and contains composite wood products that comply with the applicable California Code of Regulations Section 93120.2(a) Phase 2 (P2) formaldehyde emission standards specified on the above date of manufacture.

NI-151

NOTICE

This vehicle is designed as a Recreational Vehicle. When used for an extended period of time, while furnace heating is required, sweating and condensation conditions may occur.

The following precautions should be taken to minimize these conditions:

- (1) Use range hood when cooking.
- (2) Use the bathroom power vent when bathing or showering.
- (3) Open windows slightly for ventilation whenever possible.
- (4) Use dehumidifier to keep humidity as low as possible.

NI-13

Dash Overhead Fan Overview (Diesel Coaches)

This article provides an operational overview of the dash overhead fans for a diesel coach.

With the ignition key on, the O.H. Fans dash switch turns the overhead fan(s) on or off. The switch next to it labeled "High / Med / Low" allows the user to select the desired fan speed. The fan's purpose is to help circulate air around the windshield to minimize fog or ice buildup.



Fan-Tastic Vent Fan Operation via the KIB LCD Touchscreen

This article provides brief operating instructions for a KIB LCD touchscreen.

Overview

Touch the inactive (blank) screen to activate and display the Lighting screen. Once the panel becomes inactive and times out, it will default back to the blank screen. Touch the Home icon to reveal the Home Menu page, which may include buttons for lighting, shades, fans, systems, or display brightness controls, as well as as icon in the upper right corner for More Information (i). Once a button is touched, it will turn red, indicating the circuit is active. The buttons are gray while the circuit is inactive.



Fans

Touch the FANS button. Then select which fan you wish to operate. Once a button is touched, it will turn red, indicating the selected fan location. The buttons are gray while the circuit is inactive. The available buttons will vary by coach model and floorplan, as well as installed options, may include, but are not limited to:

- KITCHEN
- MASTER BATH
- STOOL ROOM

The fan operation screen provides buttons for On/Off, Rain Sensor Override, as well as the fan speed (High, Medium, or Low). A red button indicates the fan is currently in operation, which fan speed is selected, or the automatic rain sensing technology is disabled.

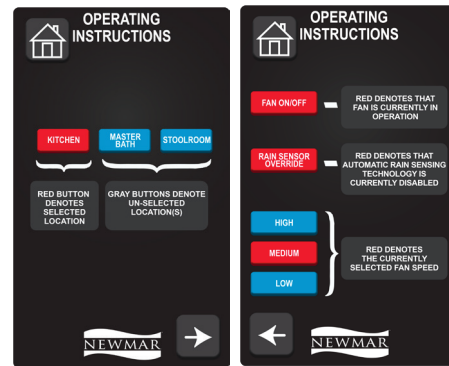

Hydronic Heating

Hydronic Zone Heating systems make climate control simple and effective.

Oasis Hydronic Heating Overview

This article provides basic operating instructions for the Oasis Hydronic Heating system.

For your comfort, your coach may be equipped with the Oasis heating system. This system uses a boiler and a pump to heat and recirculate hot fluid through a series of convectors placed strategically throughout your coach. Fans located on the convectors provide circulation of the warmed air for even, efficient heating.

How Hydronic Heating Works

Hydronic central heating is the use of a heat generator commonly called a boiler (or furnace) to raise the temperature of a heating medium, generally water or water and glycol mixture. The heated fluid is then circulated from the boiler through pipes to heat emitters such as passive radiators, convectors and underfloor heating coils, through the interior of the motorhome, and domestic hot water heat exchanger. The fluid loses its heat through this circulation and the cooler fluid then returns to the boiler for reheating.

⚠ WARNING

Never attempt to modify this furnace. Fire, explosion, asphyxiation, or carbon monoxide poisoning may occur. If the furnace malfunctions, consult a trained service technician.

The Oasis system uses two different sources for heat. The primary heat source for the Oasis system, and most efficient, is the diesel burner, which uses diesel fuel from the fuel tank to burn and create heat. The output of the diesel burner is 50,000 BTU's. Select double shower floorplans may be equipped with the 85,000 BTU model.

The second heat source is an electric heating element. It is important to note the difference between the two systems. The electric heating elements have two 5,000 BTU heating elements and should be used only to help

maintain the temperature once the diesel burner has brought the system up to proper operating heat levels. From a cold start, the 5,000 watt electrical heating elements will not operate the system alone.

Pressing the Elec 1 and/or Elec 2 ON/OFF button from the Oasis control panel or SilverLeaf touchscreen display will turn them on or off. Pressing the Burner ON/OFF button will turn the diesel burner on or off. For the most heat and hot water capability, Newmar recommends turning on both electric elements and the diesel burner.



Domestic Hot Water

For information regarding domestic hot water via Oasis hydronic heating, refer to Newgle.

Oasis Zones

For heating, your unit is divided into three “zones” on your thermostat or your climate screen, if your coach is equipped with the SilverLeaf system. The “Furnace” mode will appear in all four zones, but only three are active.

ZONE 1 - DASH, LIVING ROOM, AND KITCHEN CONVECTORS

These convectors are located under the dash and kitchen cabinets, and control heat in the cockpit, living room, and kitchen areas. The dash mounted convector is the only one in your unit that has a two speed fan. The switch controlling the fan speed is located in the front overhead cabinet adjacent to the diesel boiler switch.

ZONE 2 - MIDDLE AC AND HEAT PUMP

ZONE 3 - BATHROOM CONVECTORS

These convectors are located in the bathroom cabinetry and stool room. The fan switch for the stool room (marked "HEAT") must be in the "ON" position to provide heat in the stool room. In order to receive heat in the Stool Room, a "rear" zone (bathroom or bedroom areas) must be chosen on your thermostat or your climate screen, if your coach is equipped with the SilverLeaf system.

ZONE 4 - BEDROOM CONVECTORS

These convectors are located throughout the cabinetry and walls of the rear bedroom area. To activate the Oasis heating system, select your heat source, either diesel or electric, using the switches in the front overhead cabinet or through the SilverLeaf system. Once you have selected a heat source (diesel or electric), and the boiler is operational, set thermostat for the desired zones.

The system will turn convector fans off and on according to the temperature settings.

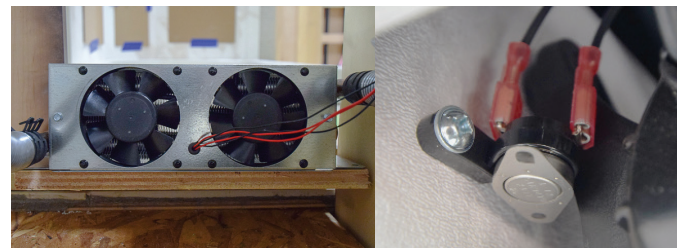

Oasis Dual Fan on Basement Heat Exchanger

Oasis Bi-Metallic Thermostat

COACHES WITH A DOMETIC THERMOSTAT OR KIB LCD TOUCHSCREEN PANEL (2A-4.3")

Set the thermostat zones on "Furnace" mode, and adjust each interior zone temperature setting as desired. The separate Oasis System switches must be turned on, and the water temperature in the Oasis System must be up to temperature for the basement heat to work.

COACHES WITH SILVERLEAF

The Oasis System must be turned on from the SilverLeaf touchscreen, and the water temperature in the Oasis System must be up to temperature for the basement heat to work.

Note: The basement heat only works when the furnace (Oasis System) is activated. It will NOT function if the Oasis System is off and the coach is being heated via the roof air conditioner heat pumps.

⚠ NOTICE

For more information, please refer to the Thermostat sub-category or the Climate Control section within the SilverLeaf Functional Guide in Newgle.

⚠ IMPORTANT

The Oasis 'diesel burner' heat source provides approximately 50,000 BTU's of heat, and is designed to start and operate the system at full capacity. The electrical heating element provides approximately 5000 BTU's of heat.

Resetting The Oasis System

⚠ IMPORTANT

In the event of a fault in the Oasis system, the system will need to be reset.

To reset the Oasis system, press the exterior reset button on the face of the Oasis, or turn the burner switch off, then back on inside the coach. The reset will clear faults such as Low Voltage, Flame Out, or a Low Fluid Level switch fault, which typically clears on its own when the fluid level becomes sufficient. The Oasis will try to start twice when there is a Flame Out fault. When it fails to start the second time, it will then display a fault on the face of the Oasis and on the System Diagnostics screen within the SilverLeaf system (if equipped).

⚠ IMPORTANT

The exterior reset or the cycling of the ON/OFF button inside the coach will not reset the system if there is a component fault, like a pump or other internal issues.

BASEMENT HEAT CONVECTOR(S)

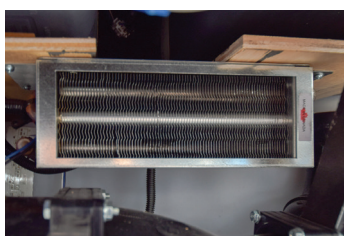

Oasis Basement Heat Exchanger

Coaches with Oasis Hydronic Heating will have a heat exchanger, dual fans, and a designated thermostat. The basement heat is activated by a separate fixed thermostat in the basement area when the compartment temperature falls below approximately 40 degrees Fahrenheit. If this happens, the hot antifreeze solution in the Oasis system will circulate, and the blower will turn on to supply heat in the basement/water compartment area. The Oasis system must be turned on and the fluid must be above the low temperature cutout for heat output.

⚠ CAUTION

Any faults not resettable by cycling the switch or by the Oasis reset button should be diagnosed and repaired by a qualified technician.

Source: Oasis FAQ

Oasis Hydronic Heating System Operation (Model: Chinook)

This article provides an operational overview of an Oasis Hydronic Heating System (Model: Chinook).

Overview

The Oasis® Chinook Heating System uses a 50,000 BTU (true output) diesel burner (12 VDC) controlled by a multi-functional electronic controller as the primary source of heating coolant fluid (anti-freeze and water). Two 1500 Watt, 120 VAC immersion elements are used as secondary heat sources to provide an additional 10,000 BTU of heat.

The Oasis® Chinook Heating System heats the coolant fluid to provide a source of heat for all hydronic space heating needs. Through the use of its integral distribution pumps, the Oasis® Chinook Heating System has the ability to circulate the coolant fluid to all space heating areas. It can also provide a supply of potable hot water using the integral heat exchanger. The Oasis® also incorporates engine heat and preheat (optional) functions.

Operating Instructions

TURNING THE POWER TO THE OASIS CHINOOK HEATING SYSTEM ON

The Oasis® Chinook Heating System’s main Control Panel, located on the front of the heater, contains three push buttons: ON/OFF power, Bypass, and Reset. The power switch must be pushed ON (power LED will turn ON) to turn the DC electrical power to the main control board ON and is required to be left ON whenever heat is required.

The Zone Control board (Figure 8-4) will be powered whenever the master disconnect switch is ON. The master disconnect switch must be left ON whenever heat is required.

When the Oasis® Chinook Heating System is shut down for any extended period or the season, it is recommended that the power switch and the battery master disconnect switch be turned OFF.

⚠ NOTICE

Do not operate the Oasis® Chinook Heating System until a suitable water/anti-freeze solution is in the heater and all trapped air has been bled or removed.

⚠ DANGER

Use only a non-toxic propylene glycol based coolant with additives generally recognized as safe "GRAS" by the FDA in the Oasis® Chinook Heating System.

ACTIVATING THE BURNER (PRIMARY HEAT SOURCE)

The burner switch on the Remote Operating Panel controls the ON/OFF of the diesel burner (primary heat source). When the burner switch is turned ON, the diesel portion of the Oasis® Chinook will turn ON after ten seconds. The Burner LED will turn ON when the diesel burner has been activated. The burner will continue to operate until the coolant in the Oasis® Chinook reaches cycling temperature. At this point, the diesel burner will turn OFF.

If the Oasis® Chinook Heating System coolant should cool down below this temperature range, the burner will again commence firing and will continue until either the burner switch on the remote panel is turned OFF or cycling temperature is again achieved. If the burner switch on the remote panel is turned OFF, or cycling temperature is achieved, the burner stops and the Oasis® Chinook enters a two minute cool down stage prior to completely shutting down.

ACTIVATING THE AC HEAT (SUPPLEMENTAL)

Place the AC power switch on the Remote Operating Panel to either the one element or two element position. The AC Heat (green) LED will turn ON indicating the AC element(s) are energized and the coolant is being electrically heated. The elements will continue to operate until the coolant in the Oasis® Chinook reaches cycling temperature. At this point, the elements and the AC heat LED will turn OFF.

If the Oasis® Chinook Heating System coolant should cool down below this temperature range, the AC element(s) will again be energized and will continue until either the AC switch on the remote panel is placed in the OFF position or cycling temperature is again achieved. If the AC element switch on the remote panel is turned OFF, or cycling temperature is achieved, the AC elements are de-energized and the AC Heat (green) LED turns OFF.

ACTIVATING THE BURNER AND AC IMMERSION ELEMENT(S) JOINTLY

Turn the burner switch ON and place the AC power switch on the Remote Operating Panel to either the one element or two element position. The Burner and AC Heat (green) LED’s will turn ON indicating the diesel burner and AC element(s) have been selected.

Functions Of The Remote Operating Panel

The Oasis Heating System's Remote Operating Panel contains one ON/OFF burner switch, one triple position AC element switch, one ON/OFF engine heat switch to control the optional engine preheat pump, and four LED's indicating Burner activation, AC element activation, heater fault, and zone fault.

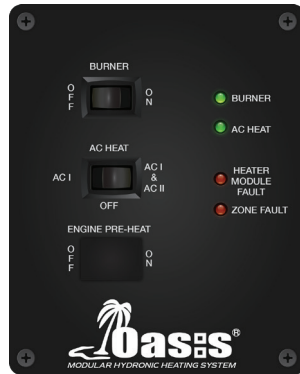

BURNER SWITCH (PRIMARY HEAT SOURCE)

The burner switch on the remote panel controls the ON/OFF of the diesel burner. The Burner LED will turn on when the diesel burner has been activated, and will remain ON while the burner cycles on and off.

AC ELEMENT SWITCH (SUPPLEMENTAL HEAT SOURCE)

The triple position AC element switch controls the activation of a single 120 VAC immersion element only, dual 120 VAC immersion elements jointly, or both elements off. The AC heat LED will turn ON to indicate when the element(s) are operating.

ENGINE PRE-HEAT SWITCH (OPTIONAL)

The engine pre-heat switch (optional) controls the ON/OFF of the engine pre-heat pump (optional). However, the engine pre-heat pump (not included) will not function unless the coolant in the Oasis® Chinook Heating System has achieved a preset temperature.

BURNER LED (GREEN)

When ON, indicates the diesel burner has been activated.

AC HEAT LED (GREEN)

When ON, indicates one or both of the 120 VAC immersion element(s) are operating.

HEATING MODULE FAULT LED (RED)

When ON, indicates the Oasis® Chinook has faulted. The specific fault can be identified by examining the Control Panel located on the front of the Oasis® Chinook. There are indicator LED's on the panel that are used for diagnostics.

ZONE FAULT LED (RED)

When ON, indicates a space heating zone(s) has faulted. The specific fault can be identified by examining the Zone Control Board located beside the Oasis® Chinook. There are indicator LED's on the panel that indicate the problem.

Functions Of The Oasis Chinook Control Panel

The Oasis® Chinook Control Panel (Figure 8-2) contains three push buttons: Power ON/OFF, Bypass, and Reset. In addition, it contains nine LED's indicating Power, AC Heat, Compressor, Fuel Pump, Combustion Fan, Igniter, Flame Out, Voltage Fault and Low Water.



POWER BUTTON

The power button turns ON/OFF the power to the control board. The Power LED (green) turns ON when the power to the control board is ON.

BYPASS BUTTON

The bypass button is for authorized service personnel only.

RESET BUTTON

The reset button when pressed resets the control board.

POWER LED (GREEN)

The power LED (green) turns ON when the power to the control board is ON. The LED flashes when the Oasis® Chinook is in Bypass mode (authorized service personnel only).

AC HEAT LED (GREEN)

The AC Heat LED (Green) turns ON when 120VAC is connected to the unit and the system has not yet reached the set point operating temperature.

COMPRESSOR, FUEL PUMP, COMBUSTION FAN, IGNITER (GREEN)

The compressor, fuel pump, combustion fan, and igniter LED's (Green) turn ON when the component is ON, and will flash if the component is electrically open or shorted.

FLAME OUT (RED)

The Flame Out LED (Red) turns ON when a flame fault has been detected.

VOLTAGE FAULT (RED)

The voltage fault LED (Red) turns ON when a voltage fault has been detected.

LOW WATER (RED)

The Low Water LED (red) turns ON when a low coolant level in the Oasis® Chinook has been detected.

Functions Of The Zone Control Board



The Zone Control Board (Figure 8-5) contains seven green LED's for Power, Zone 1, 2, 3, 4 and 5 Thermostats, and Potable Water.

It also contains nine matched pairings of red/green LED's for Zone 1, 2, 3, 4 and 5 Fans, Summer Loop, Heat Loop 1, Heat Loop 2, and Engine Pre-heat Pump.

For the Zone Control Board to respond to a call for heat, the coolant temperature inside the Oasis® Chinook must be above 120F.

The Oasis® Chinook has a single space heating loop. The “series” jumper on the zone board (below the bypass jumper, to the left of the largest relay on the board) must be put in place. If the “series” jumper is not put in place, then the thermostats calling for heat in zones 3, 4, and 5 will not activate the Heat Loop 1 pump, which is the only space heating pump in this system. This will result in cold air blowing from the fans when only zones 3, 4, or 5 are calling for heat.

When the “series” jumper is not in place, the zone control board uses Heating Loop 1 to supply coolant to Zones 1 and 2, and uses Heating Loop 2 to supply coolant to Zones 3, 4, and 5. Zones 1 and 2 are calling for heat, the zone control board will activate the Heat Loop 1 pump. When Zones 3, 4, and 5 are calling for heat, the zone control board will activate the Heat Loop 2 pump.

When the Engine Pre-Heat switch is turned ON, the Zone Control Board will turn on the Summer Pump and circulate hot coolant through the engine heat exchanger. At the same time, the engine pre-heat pump will turn ON and circulate the engine coolant through the engine heat exchanger.

How to Operate the Hydronic Heating Front Fan

The **Front Fan Switch** on the dash controls the speed of the under-dash hydronic heating fans.



When the potable hot water is turned ON, the Zone Control Board will turn on the Summer Pump and circulate hot coolant through the internal potable water heat exchanger.

When the Burner is turned ON, the Zone Control Board will turn on the Summer Pump and circulate hot coolant through the internal circuit, to provide even heating in the coolant tank.

⚠ NOTICE

The Summer Loop is an automatic action of the Oasis system and requires no action from the user. It works like a stir pump and causes water to flow through the heat exchanger when hot water is desired and the heat zones are not actively circulating.

POWER LED (GREEN)

The power LED turns ON when the power to the Zone Control Board is ON.

ZONE 1, 2, 3, 4, 5 THERMOSTAT LED'S (GREEN)

The Zone # LED turns ON when the thermostat in the zone is calling for heat.

POTABLE WATER LED (GREEN)

The potable water LED turns ON when there is a call for potable hot water.

ZONE 1, 2, 3, 4, 5 FANS, SUMMER LOOP, HEAT LOOP 1, HEAT LOOP 2, ENGINE PRE-HEAT PUMP PAIRED LED'S (RED/GREEN)

The nine paired LED's indicate the functionality of the corresponding devices. The green LED will turn ON when the device is operating normally. The red LED turns ON if a fuse has been blown.

Source(s): ITR Oasis Chinook Heating System Installation and Operating Manual: Diesel and AC Heating System for Recreational Vehicles and Mobile Homes

Product(s): ITR Oasis Chinook Heating Base Unit (Model: 59000, Newmar Part Number: 144634)

⚠ NOTICE

The switch is only active when the hydronic heat is up to temperature and the living room zone is calling for heating. When these conditions are met, the driver can use the switch to control the fan speed (low or high) or turn the fan off.

Domestic Hot Water via Oasis Hydronic Heating

The hot water in your coach is heated by the Oasis hydronic heating system. To operate an appliance that uses hot water, or to assure plenty of hot water for showering, turn on the boiler or heating elements using the Oasis control panel or the SilverLeaf touchscreen (if equipped) located in the front overhead cabinet.

Both heat sources (diesel burner and heating elements) can be used at the same time for the maximum water heating capability. Turning only the 120 volt heating element(s) on will usually provide sufficient hot water for most household chores, but may not be sufficient for showering.

The diesel burner is the primary heat source with at least 50,000 btu (more on select Oasis models), and the electric elements are secondary. Depending on your hot water usage, using only the electric elements may be sufficient; however, if not, use the diesel burner when not plugged into shore power or in conjunction with the electric elements.

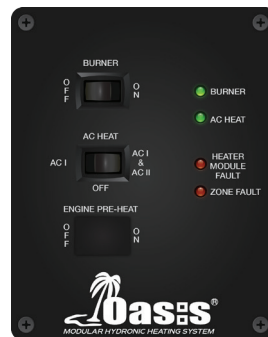

Potable Hot Water Capacity

	CH50	NE-S	CHINOOK
BTU	50,000	85,000	50,000
Maximum Water Temperature (at incoming water temperature of 60°F)	120°F	120°F	120°F
Gallons Per Minute (GPM)	1.5	3.0	1.5



Radiant Heating

This article provides an overview for radiant heating (floor heat). The floor heat uses a heat mat placed between the tile and the floor structure. A controller regulates the temperature and the timed heat cycles depending on the controls set up for your system. The floor heat operates on 120 volt AC power.

If your coach is equipped with the SilverLeaf coach management system, refer to the SilverLeaf functional guide for more information about the function and operation of the floor heat via the SilverLeaf touchscreen.

Floor Heat via SilverLeaf

The Floor Heat screen displays and controls the settings for floor heat. The floor heat control system operates by switching the different floor zone heat mats ON and OFF, as determined by the intervals and values selected.

NOTICE

The buttons and settings on the screen will vary based on coach model, floorplan, and options. The following image is an example and may not reflect the graphics depicted on your screen.

The floor heat zone settings are controlled by slider bars. Use your finger to drag the slider bar or use the up/down arrows on the touchscreen display to select your preferred time. The higher the number of bars selected, the longer the heat mat remains ON. An icon will appear above the down arrow for each zone when that particular zone is active (turned ON).

The approximate operating times are as follows based on 20 minute cycle:

- One bar: Floor Heat Off
- Two bars: Store mode (Floor Heat will not operate in this mode)
- Three bars: On ~2 minutes (“Off time” Remainder of 20 min. cycle)
- Four bars: On ~4 minutes (“Off time” Remainder of 20 min. cycle)
- Five bars: On ~6 minutes (“Off time” Remainder of 20 min. cycle)
- Six bars: On ~8 minutes (“Off time” Remainder of 20 min. cycle)
- Seven bars: On ~10 minutes (“Off time” Remainder of 20 min. cycle)
- Eight bars: On ~12 minutes (“Off time” Remainder of 20 min. cycle)
- Nine bars: On ~14 minutes (“Off time” Remainder of 20 min. cycle)
- Ten bars: On ~16 minutes (“Off time” Remainder of 20 min. cycle)
- Eleven bars: On ~18 minutes (“Off time” Remainder of 20 min. cycle)
- Twelve bars: Heat mat is activated (constantly on)



CAUTION

Per the Aries Engineering (Gold Heat) Radiant Floor Heat Installation Instructions and Owner’s Manual, “Don’t place rubber backed area or throw rugs over the heated area to avoid excessive heat from building in these areas.”



Thermostats

Keep your coach comfortable no matter where you are. Whether it’s cold or hot outside, on the inside, you will always be “just right” using your coach’s thermostat.

Climate Control via SilverLeaf

The Climate All screen controls and displays the settings for the heating and air conditioning (HVAC) system in the coach.

NOTICE

The buttons and settings on the screen will vary based on coach model, floorplan, and options. The following image is an example and may not reflect the graphics depicted on your screen.

Use the Climate All screen to manage the heating and cooling for all HVAC zones in the coach. This is a global display and control. From this screen, you can set the temperature for heating and cooling, as well as schedule temperature changes by day, night, or when you are away.

- **Status Bars and Icons:** Display the current status and operation of the HVAC system in the Climate All screen or the screen for the selected zone.
- **Icons:** During active cycles of heating or cooling, icons will appear next to the Heat and Cool buttons to indicate the active cycle:
 - Red Flame = Primary heat pump
 - Blue Flame = Secondary Oasis
 - Cyan Flame = Both heat pump and Oasis
 - Fan = A/C or heat pump fan is circulating air
 - Blue Snowflake = A/C is active
- **Heat & Cool Buttons:** Pressing the Heat or Cool button activates all the zones at one time, making the operator unable to set heat in one zone and air conditioning in another at the same time.
 - Pressing the Cool or Heat buttons toggles the function on or off.
 - If the Cool or Heat button is highlighted, the selected function is on/active.
 - If the Cool or Heat button is not highlighted, the function is off/inactive.

- **Auto Climate:** The Auto button is used to activate the auto climate feature of the HVAC system. This feature allows the temperature to be set and determines whether to use heat or A/C to maintain the set temperature. Pressing the Auto button will activate both the heat and cool buttons.
- **Temperature:** The set points are changed by using the up and down arrows to the desired temperature. All zones can be set to the same temperature from the Climate All screen or set separately in each zone selection.
- **Schedule:** Set the schedule for day, night, or when you are away within the Configuration section under “Climate Options.”

Day/Night/Return/Away/Hold

- When a ring appears around “Day,” the system is using the daytime settings.
- When a ring appears around “Night,” the system is using nighttime settings.
- When a ring appears around “Away,” the system is using Away settings.
- If a ring appears around “Away” and the user wants to return back to the schedule, press the Return button. The system will resume the daytime or nighttime settings based on the time and the configuration of the day and night schedules.
- When the user selects Hold, it will hold the temperature at its setting and ignore all scheduling until another selection is made.



Oasis Screen

The Oasis control screen can only be accessed from the Climate All screen and allows the user to control the Oasis Hydronic Heating system burner and both hydronic heating system electric heating elements.

- This screen displays the Oasis system's operational status and faults (if any). It also displays the AC Input status, including "No AC Input" or "AC Available" and the Oasis electric element (1 and 2) status.
- This screen allows the user to change the heat source: heat pump only, Oasis, both heat pump and Oasis, or "Automatic" (system detects what is needed and responds accordingly).

Using the rooftop air conditioner heat pump(s) can take the chill out of the air, but will not work correctly below approximately 40 degrees and does not provide hot water for the coach. Using the Oasis system provides more heating capability than just using the roof air conditioner heat pumps. The Oasis system works regardless of the outside air temperature and is capable of producing hot water for the coach.

The Oasis burner produces the most heat at 50,000 BTU's or more, depending on which Oasis system is used in your coach. This is necessary when heat or hot water is desired. The Oasis electric elements are approximately 10,000 BTU's each and are a good supplement to the burner when the coach is plugged into shore power.

Pressing the Elec 1 and/or Elec 2 ON/OFF button will turn them on or off. Pressing the Burner ON/OFF button will turn the diesel burner on or off. For the most heat and hot water capability, Newmar recommends turning on both electric elements and the diesel burner.



This page is intentionally blank.

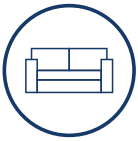

INTERIOR

This chapter provides detailed information about the furniture, cabinetry, flooring, fabrics, window coverings, and all of the interior accessories and finishing touches that turn your coach into a home.

IMPORTANT

Any of the following quick start instructions provided by Newmar should not take the place of the manufacturer's complete documentation. Refer to Newgle for more information about interior components offered for your coach's model year.



Beds and Mattresses

Several styles and sizes of beds and mattresses are available depending on your coach floorplan, such as pillow top and air mattresses. Your bed platform lifts to provide an additional convenient storage area. A strap may be provided to help raise the lid of bed base and is held open by pressurized struts to allow hands-free access.

Sleep Number Mattress Operation (Model: Comfortaire® r5)

This article provides a basic overview of a Sleep Number Mattress (Comfortaire® r5).

At the heart of the Sleep Number® bed is our most advanced DualAir™ technology. Adjustable air chambers and a Firmness Control™ system easily find your ideal level of comfort and support on each side — your Sleep Number® setting.

1. Plug your Firmness Control™ system into a working electrical outlet.
2. Your remote will turn on simply by picking it up or pressing any button. Easy-to-follow instructions will guide you through the next steps. Please wait while your mattress inflates. This will take a few minutes.



Find Your Sleep Number® Setting

There's nothing quite like finding your Sleep Number® setting — that moment when your body feels aligned, relaxed and perfectly supported. Your Sleep Number® remote is designed to easily guide you to your ideal level of firmness, comfort and support.

Begin by lying on the bed in your preferred sleeping position. Press to choose your side of the bed. Press and choose Sleep Number®. Press and choose Find Sleep Number®. Follow the instructions on your remote to find your favorite Sleep Number® setting. This may take a few minutes.

1. Over time, you may want to try different Sleep Number® settings to see what's most comfortable for you. Try a setting for two to five nights. If you're not comfortable after that, try adjusting your setting by 5 or 10, increasing for a firmer mattress; decreasing for a softer mattress.
2. Remember that your Sleep Number® setting is always adjustable and can be a tremendous tool in helping both you and your partner sleep better — and feel better overall. If you've had a hard workout, are sick or pregnant, try a softer Sleep Number® setting. If you need more support for your back or hips, try a firmer setting. Use your Sleep Number® adjustability to ensure your night is meeting the needs of your day.

IMPORTANT

If you plan to travel with your Comfortaire® mattress by Sleep Number into mountainous regions, either (1) temporarily disconnect the mattress from the Firmness Control™ system hoses to allow air to escape or (2) deflate the air chambers to a Sleep Number® setting of 20.

CAUTION

Remove batteries from the remote(s) during long trips or while in storage to preserve charge.



RIGHT

- Neck and back are aligned in the same position as when you are standing
- No discomfort at shoulder and hip pressure points
- You feel the mattress support the small of your back (back sleepers) or the curve of your side (side sleepers)



WRONG

- Body alignment is not straight
- Your pillow makes your head tilt at an angle from the rest of your body
- You feel discomfort from pressure at your neck, shoulders, back, hips or legs

Product Care

To clean the surface of your mattress, follow these simple steps:

1. Spot clean the mattress cover with a solution of mild detergent, such as Woolite, and warm water or sparkling water. Avoid saturating the fabric to avoid shrinking.
2. Lay cover flat to air-dry.

⚠ CAUTION

Machine washing, dry cleaning, or heat-drying could damage the mattress cover and will void the warranty. Vacuuming the cover may snag, soil or otherwise damage it.

Source(s): Sleep Number Comfortaire r3 and r5 Beds Assembly Guide

Product(s): This source is associated with more than one product. Refer to Newgle for more information about the product(s) offered for your coach's model year.



Cabinetry and Woodwork

Cabinetry and Woodwork Care and Maintenance

Newmar's exquisitely crafted cabinetry newly gleams with chrome-finished hardware, the perfect complement to the array of appliances that make cooking and clean-up a breeze. Amish craftsmanship and elegance in design meld the wood cabinetry and furniture seamlessly with the Newmar interior. All Newmar cabinetry is custom built in our facility and designed with function and convenience in mind, as well as to provide as much storage as possible in your coach.

Construction

All joints on Newmar hardwood cabinets are glued, and then screwed together for extra durability. Hardwood raised panel cabinet doors are standard throughout the coach. Depending on your coach model, you may have hardwood cabinets or vinyl veneer finished cabinets. A variety of vinyl veneer and stain finishes are available for the cabinetry. A hand-sanded finish helps minimize seams so your hardwood cabinetry is as beautiful as it is durable. Metal drawer guides provide a smooth opening and closing of the drawers in your coach. To open a drawer, lift up slightly and pull open. This feature helps prevent the drawers from opening during transit. Your unit may also include features such as adjustable pull out pantry boxes in the kitchen, soft-close drawers, or a molded silverware divider tray for added storage.

Humidity and Climate Change

Controlling the coach environment is the first priority of cabinet care and maintenance. Wood products shrink and grow according to the environment in which they are placed. These changes are in direct relationship to the relative humidity levels. As the humidity increases, the wood expands, and as the humidity decreases, the wood shrinks. This process does not happen instantaneously the longer the wood is exposed to low humidity, the more it will shrink as it dries out, and visa versa.

Coach owners who travel around the country may be more prone to this issue, as their coach is exposed to both extreme humidity and extreme dryness. It is necessary to acknowledge the fact that wood changes according to its environment. Newmar recommends maintaining relative humidity levels between the range of 35-50 percent and temperature levels between the range of 40-90 degrees. The air conditioner or a dehumidifier will reduce the humidity level; however in dry climates, a humidifier may also aid in maintaining the appropriate humidity levels by raising the humidity level.

The following labels are examples of the notices that may be posted in the coach in regards to condensation prevention and formaldehyde exposure.

NOTICE

This vehicle is TSCA TITLE VI COMPLIANT and contains composite wood products that comply with the applicable California Code of Regulations Section 93120.2(a) Phase 2 (P2) formaldehyde emission standards specified on the above date of manufacture.

NI-151

NOTICE

This vehicle is designed as a Recreational Vehicle.

When used for an extended period of time, while furnace heating is required, sweating and condensation conditions may occur.

The following precautions should be taken to minimize these conditions:

- (1) Use range hood when cooking.
- (2) Use the bathroom power vent when bathing or showering.
- (3) Open windows slightly for ventilation whenever possible.
- (4) Use dehumidifier to keep humidity as low as possible.

NI-13

IMPORTANT NOTICE

Certain of our forest product suppliers have advised that urea-formaldehyde is used in the production of particle board, hardwood plywood or paneling which they supply us and which we utilize in our finish product. These suppliers have requested that we communicate this to our customers.
For your information, we are reproducing samples of statements which have been provided to us by our suppliers.

WARNING: THIS PRODUCT CONTAINS A UREA-FORMALDEHYDE RESIN AND MAY RELEASE FORMALDEHYDE VAPORS IN LOW CONCENTRATIONS. FORMALDEHYDE CAN BE IRRITATING TO THE EYES AND UPPER RESPIRATORY SYSTEM OF ESPECIALLY SUSCEPTIBLE PERSONS SUCH AS THOSE WITH ALLERGIES OR RESPIRATORY AILMENTS. PROPER VENTILATION SHOULD REDUCE THE RISK OF SUCH PROBLEMS. IF SYMPTOMS DEVELOP, CONSULT YOUR PHYSICIAN.
Adorn, Inc.

WARNING: IRRITANT: THIS PRODUCT CONTAINS A UREA-FORMALDEHYDE RESIN AND MAY RELEASE FORMALDEHYDE VAPORS IN LOW CONCENTRATIONS. FORMALDEHYDE CAN BE IRRITATING TO THE EYES AND UPPER RESPIRATORY SYSTEM OF ESPECIALLY SUSCEPTIBLE PERSONS SUCH AS THOSE WITH ALLERGIES OR RESPIRATORY AILMENTS. PROPER VENTILATION SHOULD REDUCE THE RISK OF SUCH PROBLEMS. IF SYMPTOMS DEVELOP, CONSULT YOUR PHYSICIAN.
Woodbridge, Inc.

WARNING: THIS PRODUCT CONTAINS A UREA-FORMALDEHYDE RESIN AND MAY RELEASE FORMALDEHYDE VAPORS IN LOW CONCENTRATIONS. FORMALDEHYDE VAPOR MAY, IN SOME PEOPLE, CAUSE HEADACHES, EYE, NOSE, AND THROAT IRRITATION AND AGGRAVATION OF ALLERGIES AND RESPIRATORY PROBLEMS, SUCH AS ASTHMA. PROPER VENTILATION SHOULD REDUCE THE RISK OF SUCH PROBLEMS.
Robert Weed Plywood Corp

Ventilation is important in maintaining a comfortable environment and we direct your attention to the discussion of ventilation contained in your Owner's Manual.

⚠ NOTICE

Hardwoods may change color or darken when exposed to sunlight. It is important that the window shades be down during long periods of storage. Changing shades of color, or discoloration, from exposure to sunlight is not a warrantable repair, as it is the nature of the hardwood products in your coach.

Care and Maintenance

The cabinetry should be wiped down with furniture polish to sustain the natural beauty and luster of the wood.

⚠ IMPORTANT

As with any wood product, do not saturate these cabinets with water or any other liquid. Be sure to wipe up spills as they occur to avoid staining.

Kitchen Cabinet Extension, Peninsulas, and Islands Overview

This article provides basic information about kitchen extensions, peninsulas, and islands.

Pull-Out Cabinet Extensions

The cabinet “extension” is incorporated directly into the kitchen cabinetry, and glides out on drawer guides to provide additional counter space when needed.



Pull-Out Cabinet Extensions Example

COACHES BUILT IN OR AFTER 2017

Most 2017 and newer coaches are equipped with a counter extension and an electric latch release. To extend the counter:

1. Turn on the coach battery disconnect.
2. Extend the slideout.
3. Press the button right above the pull-out island (between the counter extension and the main countertop) to release the island extension.
4. Pull out on the extension until the magnetic catches engage.

To retract the counter, push in the extension until it latches.

COACHES BUILT PRIOR TO 2017

On older coaches, unlock the extension by accessing the lever located in the top drawer.

⚠ CAUTION

All pull-out cabinets must be secured prior to transit, as damage to the cabinetry and/or interior of the coach, or physical injury, may occur.

Stationary Peninsulas

The stationary peninsula provides additional storage and countertop space. The kitchen slideout extends and retracts around the peninsula while it stays in place.



Stationary Peninsula Examples

⚠ IMPORTANT

Make sure the countertop is clear of obstructions or debris in the path of the slideout before extending or retracting the slideout. Do not allow any objects to fall between the peninsula and the slideout, as they may cause damage.

Stationary Islands

The island provides additional storage and countertop space. The stationary island may house the central vacuum system, as well as crucial plumbing and electrical fixtures.



Stationary Island Example

⚠ IMPORTANT

Make sure the areas around the island are clear of obstructions or debris and all cabinet doors are securely closed before retracting the slideouts.



Ceiling and Walls

The ceiling and walls in your coach are designed with more than function in mind, they are pleasing to the eye as well.

Ceiling and Walls Care and Maintenance

The ceiling in your coach may be covered with a padded vinyl ceiling headliner and should be cleaned periodically to maintain a new appearance. Use a non-abrasive cleaner with a soft cloth. Do not use solvents of any kind, as they may damage the surface.

The decorative wall coverings can easily be maintained and are not much different from wallpaper and should be cleaned with a solution of mild soap and water or a non-abrasive cleaner with a soft cloth.

⚠ CAUTION

For stubborn spots, test any cleaner on a area that is hidden, as some cleaners may fade or discolor the wall covering. Do not use solvents of any kind, as they may damage the surface.



Countertops and Backsplashes

Solid Surface Countertop and Backsplash Care and Maintenance

This article provides proper care and maintenance instructions for solid surface countertops and backsplashes. No special cleaning products are necessary; however, the countertops and backsplashes can be damaged if they are not cared for properly.

Cleaning

The solid surface composite countertops are non-porous, so most dirt and liquids sit on the surface and can easily be cleaned with a soap or mild detergent.

Wipe up spills as soon as they occur. Film can also build up on the countertop if water is left to dry, making it appear blotchy and uneven. Always wipe the countertop completely dry with a soft cloth after spills and cleaning.

Spray the surfaces with a hard-surface cleaner, and leave it for a few minutes before wiping clean with a damp cloth. Strong chemicals and solvents may damage the surface and should be wiped up immediately, then rinsed with water.

⚠ IMPORTANT

Avoid using window cleaners that may leave a waxy build-up that dulls the surface.

Avoiding Damage

HEAT

The solid surface countertops can be damaged with excessive heat or the use of harsh chemicals. Never put hot pans directly on the counter or in the sink. Avoid pouring hot liquids directly into a solid surface sink; run cold water while pouring hot liquid into the sink to avoid damage. If possible, allow the pan or pot to cool first.

Use caution when using heated appliances, such as crock-pots, electric frying pans, toaster ovens, etc. When possible, never use these appliances directly on the countertop.

IMPORTANT

Always use a heat pad or trivet to protect the surface from heat that may mar or damage the surface.

CHEMICAL SPILLS

Strong acids and cleaners may discolor the surfaces and should be wiped up immediately and cleaned with soapy water to prevent damage to the surface. Prolonged exposure may require professional repair or replacement.



Fabrics and Materials

Newmar uses only the most highly regarded names in residential décor to make their finest luxury coach a reality. High-quality fabrics are used throughout your coach, including the bedspread, shams, accent pillows, draperies, headboard, valances, and much more.

Dash Material Maintenance

This article provides suggested maintenance instructions for the dash material. In order to keep the dash in like-new condition, follow these guidelines:

Do-

- Dust and clean the dash with a soft, damp cloth, or chamois, wiping the surface gently.
- Use a mild detergent and lukewarm water.
- Dry the surface, after washing and rinsing, by blotting with a damp cloth or chamois.

Do Not-

- Use harsh chemicals that may damage the dash.
- Use cloths containing grit or abrasive particles or kitchen scouring compounds to clean or dust the dash.
- Subject the dash to hard, direct blows.
- Use boiling water or strong solvents to clean the dash, as they will soften the plastic.

Fabrics and Materials Care and Maintenance

This article provides care and maintenance recommendations for the fabrics and materials installed in a Newmar coach.

IMPORTANT

The fading of upholstery, carpet and other interior fabrics can be caused by excessive sunlight. The drapes, blinds, or shades should be kept closed if the coach will be parked for an extended period of time to minimize fading. Normal deterioration due to wear and/or exposure to sunlight is not covered by the Newmar Limited Warranty.

The fabrics used in your coach may contain fire-retardant additives that may be damaged by use of improper cleaning products. Cleaning instructions for these items are DRY CLEAN ONLY. Water-based products are not recommended for cleaning the fabrics in your new unit. Most water-based household cleaning products are not formulated for use on these fabrics and may cause excessive shrinkage or fading. For best results, the fabrics in this unit should be cleaned by a professional carpet and upholstery cleaner.

SCRATCHES

Try not to cut or chop food directly on the countertop, as you can score and scratch it. Slight abrasion marks may occur during normal daily use; cleaning regularly will ensure the durability and longevity of the countertops. Darker and heavily pigmented colors may show wear and tear more readily, and may require additional or more frequent maintenance.

Some deep scratches can be sanded out, and defects in solid surface countertops can be repaired, by trained professionals.

IMPORTANT

Always use a cutting board when cutting or chopping. Never cut or chop food directly on the countertop.

IMPORTANT

Some stains or soils are extremely difficult or impossible to be removed completely. These should receive immediate, professional attention. Spills, spots, stains or soils are the responsibility of the owner, and are not covered by the Newmar Limited Warranty.

⚠ WARNING

When cleaning the upholstery and fabric in the unit, do not use lacquer thinner, nail polish remover, laundry soaps, or bleach. Never use carbon tetrachloride or gasoline for cleaning purposes. These items may cause damage to the materials being cleaned, and most are highly flammable.

Ultrafabrics Cleaning Guidelines for Vinyl-Covered Furniture

This article provides the care and maintenance guidelines for Ultrafabrics material.

One of the best ways to keep Ultrafabrics looking great is through proper maintenance and regular cleaning to prevent excessive dirt from accumulating. To help keep your quality fabrics looking their best, follow these guidelines to extend the life of the fabric:

- Wipe up spills as soon as they occur
- Clean with soap and water or alcohol based cleaners
- Sanitize using disinfectants such as (1:5) bleach/water solution
- For stubborn stains, wipe off with isopropyl alcohol as soon as possible
- Thoroughly rinse all solution residue with clean water
- Air dry

This information is not a guarantee. Please use all cleaning and disinfecting agents safely and as instructed. The use of other cleaning agents, disinfectants, conditioners or protectants is not recommended and can degrade fabric’s performance and may void Ultrafabrics warranty.

Ultraleather® | Pro note: A variety of clothing and accessories may contain dyes that could transfer to lighter colors, depending upon variations in temperature and humidity. Dye transfer is difficult to control, not always fully preventable, and may be irreversible. Fabric may not protect against intentional stains or permanent inks.

Source: Recommended Cleaning Instructions for Ultrafabrics



Flooring

Flooring – both tile and carpet – is installed with Newmar’s own in-house process, ensuring the best in quality and longevity, as well as the finest fit. The flooring in every Newmar coach – from our high-quality, durable tile to the plush, luxurious carpeting— is placed with the highest level of care.

Tile Floor Care and Maintenance

This article provides care and maintenance recommendations for tile flooring, which installed with Newmar’s own in-house process. The tile in every Newmar coach is placed with the highest level of care for the best fit, quality, and longevity.

As needed, sweep your floor to remove dirt and grit. Wipe up any spills promptly. Damp mop once a week (or more often for heavy traffic areas) using a tile cleaner. Use a neutral pH cleaner compatible with grout cleaning.

⚠ IMPORTANT

Slideout rollers may leave indentations in the flooring. This condition is normal and does NOT warrant flooring replacement.

⚠ IMPORTANT

Never use detergent, soap or other harsh cleaners, which can dull the surface or promote mildew growth. Cleaners should never contain acids, vinegar, chlorine, or ammonia, as these chemicals can damage and discolor both the grout and the stone or tile.



Interior Doors and Hardware

The interior doors add to the beauty and privacy of your coach. Newmar installs a variety of functional doors from the basic hinged-swinging door, recessed hardwood pocket doors, and even pivoting doors on select floorplans. Each interior door is designed to fit and function for trouble-free operation.

⚠ IMPORTANT

Always secure all interior doors prior to travel to prevent damage to the doors and any surrounding objects.



Interior Furnishings

Interior furnishings such as clocks, artwork, and other decorations help make your coach feel like home. Other furnishings may be installed to provide the essentials and the amenities for your convenience while traveling.

Interior Furnishings Overview

Pictures, Clocks, or Wall Art

Most pictures and wall art installed at the factory have a hanger at the top and Velcro at or near the bottom. There may also be Velcro on the sides. To remove the picture or wall art, pull the Velcro loose at the bottom and sides, and then remove it from the hanging device. Some decorations without a frame may have exposed screws that may be difficult to find. For this type of decor, locate the screws, and remove them.

Furniture Overview

Covered in coordinating fabrics and accented with pillows, a variety of furniture is available in your coach depending on coach model and floorplan as well as the options that were ordered. Options may include recliners, theater seating, sofa beds, dinettes, and booths. Your furniture is designed with function and style in mind. Many of the furniture pieces are multifunctional and may recline, turn into sleeping areas, open to access hidden storage areas, etc. Any furniture that has seatbelts installed from the factory have been tested and are intended only to be used in the seating position when the slideouts are in the retracted position for travel.

WARNING

Do not attempt to use recliners, theater seating or any furniture that opens or reclines and changes from the basic seating position unless the coach is in the set-up position (i.e., parked and with the slides open). Otherwise, occupants may become injured, and furniture and surrounding items may become damaged.

Driver and Passenger Seat Overview

This article provides an overview of driver and passenger chairs installed on a Newmar coach.

IMPORTANT

This article is intended to provide a basic overview of the driver and passenger seats and is NOT all-inclusive of available features on any one particular seat. Chair manufacturers, styles, and features vary by coach. Seat features may be controlled via rocker or joystick-style switches, levers, knobs, or buttons. For additional information about driver and passenger seat operation, refer to Newgle.

The fabric and color of the chairs is based upon the décor package selected at the time of production. The driver and passenger seats may be standard or wide-width and are covered in vinyl or leather. Some coach models feature branded seats with the logo of the coach model. Other variations may include notched arms and/or skirt panels. The seats have a three-point seat belt, which may be integrated into the seat. Some seats may also be operated via a remote control with additional features.

Standard and Optional Features of Driver and Passenger Chairs

ADJUSTABLE BASE

Chairs may have a powered or manual adjustable base. Powered driver and passenger front seats are mounted on power pedestals that offer a wide range of adjustments. A joystick-style switch typically moves the seat horizontally and vertically, a rocker switch tilts the front of the seat up and down, and another switch often controls the tilt of the rear of the seat base. Additional switches or knobs, depending on the coach year and model, control the recline angle of the seat back.

SWIVEL

When the coach is not in motion, some seats may have the option to swivel (turn around) to face the living room of the coach via a release lever on the pedestal. Before turning the chairs, follow this procedure:

- First extend the slideout room.
- Tilt the steering wheel up and toward the dash.
- Position the armrest to provide maximum clearance.
- Straighten the seat back.
- Move the seat forward or backward to provide enough clearance for the steering wheel. Additional adjustments may be necessary during this process.

Once these steps are completed, the chairs will swivel without interference.

⚠ **WARNING**

Be sure that driver's seat is in the forward position before activating the slide out room.

NI-043

ADJUSTABLE LUMBAR SUPPORT

Some driver and passenger seats may be equipped with a lumbar support in the lower back region of the seat. The power lumbar control switch is located on the side of the seat and can be used to adjust the lumbar portion of the seat. This setting determines the amount of pressure applied to the user's lower back.

FOOT REST

Some driver and passenger seats feature a manual or power foot rest. If equipped, powered foot rests may be extended or retracted via a control switch located on the seat.

ADJUSTABLE ARMS

Some driver and passenger seats have adjustable arms that can be raised or lowered based on the user's preference. These can often be adjusted via a lever located on the armrest. Some arm rests automatically move when adjustments are made to the angle of the seat back.

HEATED SEATS

Some seats may feature heat, which can be controlled via remote control (if equipped) or a switch located on the base of the seat. This switch is often red in color and/or has a graphic with upward moving "heat rays." Seats equipped with a remote control have adjustable heat settings.

COOLED SEATS

Seats may have adjustable cooling settings via a control switch located on the seat base or remote control.

SEAT MEMORY

Select coaches may be equipped with a memory package that allows you to set and store up different combinations of seat, steering wheel, pedal, and exterior rear view mirror positions for up to three drivers. For more information about the driver control memory system, refer to Newgle.

MASSAGE

Seats equipped with a remote control may have various massage modes and intensity settings.

HAPTIC FEEDBACK

This feature is used on coaches with a Mobileye lane departure warning system. The seat will vibrate to notify the driver if the coach leaves the intended lane.

Troubleshooting

If you experience issues with your power seats, please refer to the Fuse Panel portion of Newgle. Select your coach year, model, and floorplan to view the appropriate fuse location diagrams. These will often prove to be helpful when locating your fuse panels, positions, and ratings.



Interior Steps and Step Covers

On select coaches, the switch for the interior step cover is located either on the side of the passenger console or on the dash console near the center. This cover allows you to freely walk inside of the coach without having to be on the steps while in transit or when parked for longer periods of time. In addition, select coaches are equipped with step treads that can be lifted for additional storage.

Interior Steps and Step Cover Overview

This article provides basic information about the interior steps and step covers.

On select coaches, the switch for the interior step cover is located either on the side of the passenger console, on the dash console near the center, or near the mid-entry step well. This cover allows you to freely walk inside of the coach without having to be on the steps while in transit or when parked for longer periods of time.



In addition, select coaches are equipped with step treads that can be lifted for additional storage. Some coaches may also have a switch that operates the step well lighting.

⚠ **CAUTION**

For safety purposes, keep your steps clear of debris and other personal objects.



Safes

Stack-On Security Wall Safe Operation (Model: PWS-1822E)

This article provides basic operation instructions for a Stack-On Security Wall Safe (Model: PWS-1822E).

Getting Started

When you first receive your new electronic safe you will need to open the door with the key in order to install the batteries. Batteries are included and are located inside the safe.

⚠ NOTICE

This key can be found inside the coach information packet. This is the black bag containing user manuals and other coach-specific documentation. If the key is not available, the default code set by the factory is "1-5-9," followed by the green checkmark button. This code will only work if the batteries have already been installed and a security code has NOT yet been entered.

To open the door with the key, first remove the lock cover from the front of the faceplate using a thin bladed flathead screwdriver. Insert the key and turn left. Hold the key in the open position and turn the knob to the right to open the door.

Note: This key has been provided in case you lose or forget your security code or the batteries run low. If you lose your key, you may purchase a replacement key by referencing the serial number located under the removable lock cover. See the section at the end of these instructions regarding replacement keys.

Locate the batteries inside the safe. Open the battery compartment on the back of the door by pushing the tab in the direction of the arrow and install the batteries.

Note: The reset button located on the inside of the door is covered with a removable cap. When you use the reset button while setting your own combination, remove the cap to access the button. Use the tip of a ballpoint pen or the end tip of a paper clip to push the reset button.

Replace the cap securely over the reset button after setting your combination. Failure to do so will compromise the safety and security of the safe.

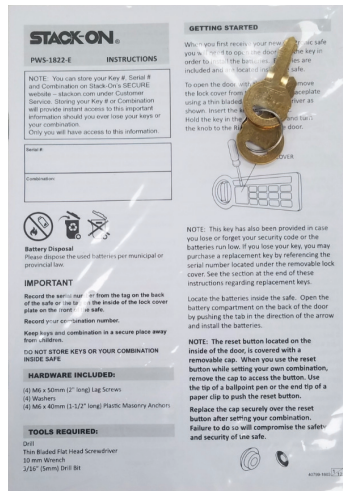

Entering Your Security Code



To enter your own security code you will need to follow the steps listed below:

1. After installing the batteries, locate the reset button on the back of the door.
2. Press the reset button with a pen and then release it; you will hear a beep. Do NOT shut the door until you have confirmed that your new security code has been entered correctly.
3. With the door open, enter your own personal security code, which can be 3-8 digits long, and confirm your new code by pressing the checkmark key on the electronic touch pad. You will have 3 seconds to press the checkmark key, otherwise you will have to start over from step one. There will be 2 beeps (if the sound is turned on) and the green light will flash twice if your code has been entered successfully. Before you close the door, enter the new security code and press the checkmark key to make sure the lock releases the knob so you can turn it and retract the live action locking bolts.

If the code fails, go through steps 1-3 again. If the code works successfully, then you should lock the safe.

When you open the safe in the future, enter the security code you have set, followed by the checkmark yet, and turn the knob.

If an incorrect security code is entered 3 times, the safe will beep 5 times (if the sound is turned on) and the red light will flash 5 times resulting in the safe being automatically locked out for 60 seconds before you can try your code again. The safe will beep one time (if the sound is turned on) and the green light will flash once when the lockout period is over.

If an incorrect security code is entered 1 additional time, the safe will beep 5 times (if the sound is turned on) and the red light will flash 5 times, resulting in the safe being automatically locked out for 5 minutes before the code can be tried again. The safe will beep one time (if the sound is turned on) and the green light will flash once when the lockout period is over.

⚠ IMPORTANT

If you write down your combination, you must keep this information in a secure place, away from children, not inside the safe.

⚠ IMPORTANT

Do not store keys or your combination inside safe.

Locking The Safe

To lock the safe, close the door and turn the knob to the left to the 12:00 position.

Battery Replacement

This safe uses 4 - AA batteries. Under normal use, batteries will last about 1 year.

- Do not mix old and new batteries.
- Do not mix alkaline, standard or rechargeable batteries.

If the batteries are low, the yellow light will flash when you start to enter your code. To replace the batteries, open the battery compartment on the back of the door by pushing the tab in the direction of the arrow and install all new batteries.



Shades and Window Coverings

Shade Operation via KIB LCD Touchscreen

This article provides brief operating instructions for a KIB LCD touchscreen.

Internal LED Light

This safe includes an internal LED light that will activate when the correct combination is entered and will remain on for 30 seconds.

Turning The Keypad Sound Off/On

Your safe comes with the “Beep” sound turned on. You can turn off the “Beep” sound of the keypad by pressing the Volume key. To turn the “Beep” sound on, press the Volume key again.

Key / Combination / RFID Device Request

⚠ NOTICE

You can store your Key #, Serial # and Combination on Stack-on’s SECURE website - stackon.com under Customer Service. Storing your Key # or Combination will provide instant access to this important information should you ever lose your keys or your combination. Only you will have access to this information.

Verification of ownership is required in order to receive a replacement Key / Combination / RFID devices for your security product.

In order to receive a replacement Key or Combination or RFID devices for your security product:

1. Please visit the following link: <https://stack-on.com/customer-service/>.
2. Locate and click on the “Replace your lost keys/combination” icon.
3. Follow the instructions provided to receive your key, combination, or RFID devices.

*Product(s): Stack-On PWS-1822-E Security Wall Safe Owner’s Manual
(Model: PWS-1822-E, Newmar Part Number: 144484)*

Overview

Touch the inactive (blank) screen to activate and display the Lighting screen. Once the panel becomes inactive and times out, it will default back to the blank screen. Touch the Home icon to reveal the Home Menu page, which may include buttons for lighting, shades, fans, systems, or display brightness controls, as well as an icon in the upper right corner for More Information (i). Once a button is touched, it will turn red, indicating the circuit is active. The buttons are gray while the circuit is inactive.

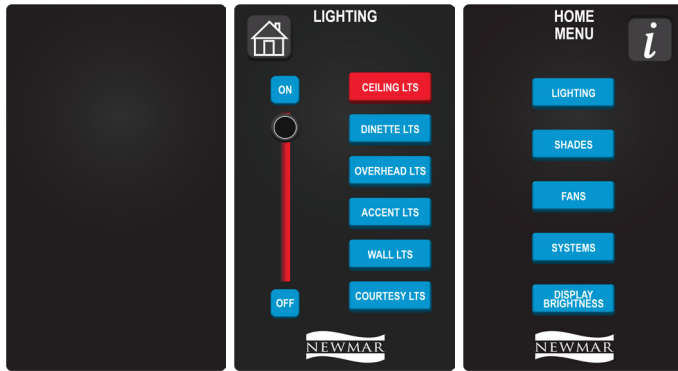

Shades

Touch the SHADES button, followed by the corresponding shade button to start and stop shade operation. Once a button is touched, it will turn red, indicating the circuit is in active operation. The buttons are gray while the circuit is inactive. The available buttons will vary by coach model and floorplan, as well as installed options. Potential buttons may include, but are not limited to:

- DOOR DAY SHADE
- DOOR NIGHT SHADE
- DINETTE DAY SHADE
- DINETTE NIGHT SHADE
- ALL DAY SHADES
- ALL NIGHT SHADES

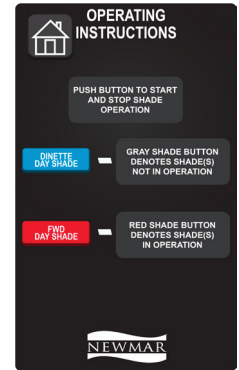

Power Windshield Shade Operation

This article provides basic operation instructions for a Power Windshield Shade.

⚠ NOTICE

This information is generic in nature and may not be specific to your exact coach model and/or year.

⚠ IMPORTANT

Do not manually pull down on the power shades, as damage may result.

Visor/Shade (Day Shade)

The Visor switch is located on the dash and adjusts the windshield screen up or down. When the ignition switch is turned on it limits the visor travel to approximately 1/2 way down and with the key off it travels all the way down to the dash. The screen will travel up until it reaches the stop setting.



Front Privacy Drape / Shade (Night Shade)

Press the UP or DOWN button for the appropriate shade. Switches may be labeled "Front Privacy Drape" or "Shade." Switch-operated shades require the switch to be held until the shade either reaches its limit or the desired intermediate position (the shade can be stopped at any point by simply releasing the switch).



The switch labeled "Front Privacy Drape" or "Shade" is located in the overhead cabinet or on the dash and adjusts the windshield shade up or down.



1. With the ignition on, press and hold the switch in the down direction to extend the drape to the ignition stop set limit, which is approximately half-way. This is to allow the driver to see out the window.
2. With the ignition off, press and hold the switch in the down position to extend the drape until it reaches the "down" stop set limit.
3. With the ignition on or off, press and hold the switch in the up position to retract the drape until it reaches the "up" stop set limit.
4. Release the switch during travel to stop the drape extension or retraction between the "up" and "down" stop set limits.

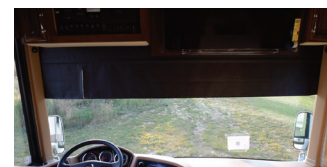

This page is intentionally blank.



PLUMBING

This chapter provides detailed information about the coach's fresh and waste water system and all of the related components: faucets and fixtures, filters, sinks and showers, toilets, and much more.

⚠ IMPORTANT

Any of the following quick start instructions provided by Newmar should not take the place of the manufacturer's complete documentation. Refer to Newgle for more information about plumbing components offered for your coach's model year. Failure to connect and operate the system correctly may result in damage not covered by the Newmar Limited Warranty.

Plumbing Overview

About The Fresh Water System

The Fresh Water System consists of the fresh water holding tank, water pump, valves, connection hoses, and fresh water plumbing lines. This system is responsible for providing potable water for drinking, cooking, bathing, and all other activities that require clean water.

The fresh water system begins with a hose or hose reel, which provides the connection to the fresh potable water. Then, via the fresh water valve, the water is diverted through the coach to be distributed through the cold water plumbing lines to the fresh water holding tank or to the cold water connections of each faucet and the water heater. From the water heater, the water is then dispersed through a series of water lines to each faucet on the hot water inlet and the hot water spigots (if equipped).

About The Waste Water System

There are two separate waste systems: the gray tank system and the black tank system, which includes sinks, lavatories, showers, tubs, and toilets. Each tank has its own control valve, and both tanks drain through the sewer drain hose. The waste water system catches and contains the used water and divert the waste water through the traps and drain lines to the grey or black holding tank(s). It is then stored until the tanks are emptied using a sanitary drain or dump station.

⚠ CAUTION

Read and understand all operating instructions for the plumbing system prior to using your coach. Failure to connect and operate the system correctly may result in damage not covered by the Newmar Limited Warranty.

2023 Mountain Aire Water Compartment Overview

This article provides a general breakdown of the components installed in a 2023 Mountain Aire water compartment.

Overview

The water compartment in the coach typically contains the tanks and most of the controls for the plumbing system. It is usually located on the driver side of the coach immediately in front of the rear wheels, as it is isolated from other compartments and is heated and insulated. The water compartment contains parts of both the fresh and waste water systems.

⚠ IMPORTANT

Some plumbing components may be located in other compartment(s) and may not be mentioned in this article or labeled in the graphic.

WATER PRESSURE REQUIREMENTS

Ease of operation was the key element in the design of the water compartment and plumbing systems. The fresh water system in your coach is designed to operate at a maximum of 60 PSI. Water pressure levels above this level can damage the fresh water plumbing. If the water pressure ever surpasses 60 PSI, a pressure regulator must be installed to reduce the incoming pressure, or fill the fresh water tank and use the internal water pump to supply water to your coach.

Example Of A 2023 Mountain Air Water Compartment

The following information is generic for the 2023 Mountain Air. Components installed may vary by floorplan or optional equipment.

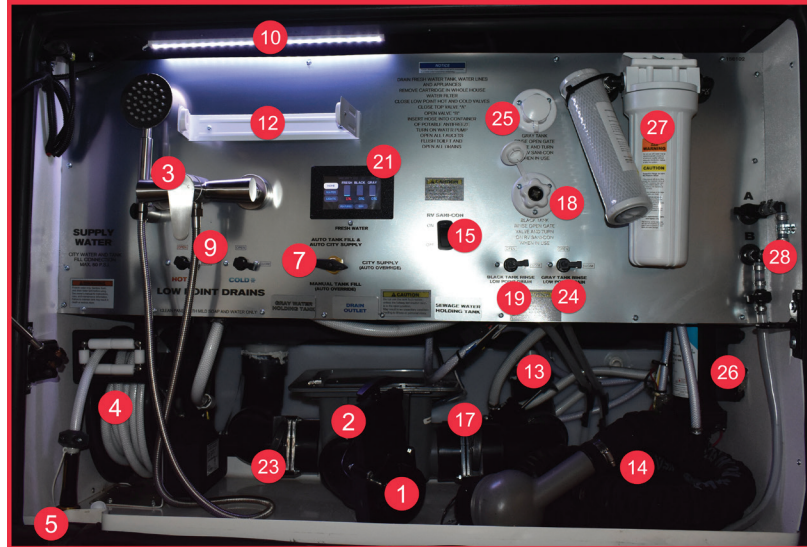

**COMPONENTS NOT PICTURED
(OR LOCATED IN OTHER COMPARTMENTS):**

- 6 Fresh Water Tank
- 11 Oasis Heat Exchanger
- 16 Sewage (Black) Tank
- 22 Waste (Gray) Water Tank

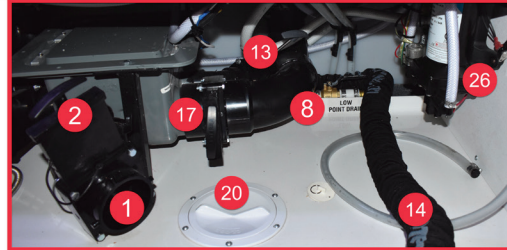

	Component(s)	Summary of Function or Operation
1	Drain Outlet and Cover	The drain outlet is used to attach a 4" sewer hose, and the drain cover is used to prevent leakage of waste material. Make sure the drain cover is securely installed on the drain outlet unless actively dumping the tanks via a 4" sewer hose.
2	Drain Outlet Gate Valve with T-Handle	The drain outlet valve allows the tank(s) to be dumped via a 4" sewer hose when macerator use is not desired or operable. Open the valve all the way by pulling on the T-handle to allow waste to flow through a 4" sewer hose. Close the valve by pushing on the T-handle.
3	Exterior Shower	An exterior shower faucet with a wand can be used to rinse off shoes and/or feet, bathe a pet, wash your hands, or rinse off the sewer hose after dumping the waste water tanks. When finished using the exterior shower, shut off both the hot and cold valves. Do not simply shut off the valve on the shower head itself, as it may cause hot and cold water to mix at the exterior shower and could allow drastic changes in water temperature throughout the coach.
4	Fresh (City) Water Connection via Hose Reel	This potable water connection is used in conjunction with the Fresh Water Fill Valve for a number of purposes, including pressurizing the plumbing in the coach and filling the fresh water tank. Connect the coach to the potable water source via the hose reel.
5	Fresh Water Hose Channel	This channel prevents the compartment door from crushing the potable water hose when the door is closed.
6	Fresh Water Tank	This tank is used to hold fresh potable water for use throughout the water system and is usually located on the floor of the water compartment; however, some coach floorplans may be equipped with a water tank located in another compartment. The fresh water tank is filled from the city water connection with a hose or hose reel via the fresh water tank fill valve or auto fill system. This tank may be located behind a panel, cover, or the macerator and may not be visible from the outside.
7	Fresh Water Tank Fill Valve	The rotating fresh water tank fill valve is used to pressurize the fresh water system in your coach, as well as to fill the fresh water tank when the coach is connected to city water. With pressurized water supply connected, simply rotate the valve to the desired position: <ul style="list-style-type: none"> • Manual fill position fills the fresh water tank when connected to a pressurized water source • Auto fill position supplies pressurized water to the coach on demand from the city water connection and, if the auto fill function is enabled on the coach's tank monitoring system (i.e. Silverleaf, KIB, or Digi-Level), fills the fresh water tank to match the auto fill settings.
8	Fresh Water Tank Low Point Drain	The fresh water tank low point drain is used to empty the fresh water tank. Open the low point drain valve to drain the fresh water tank, and close the low point drain valve when filling the fresh water tank or storing fresh water in the tank. This low point drain is located near the fresh water tank and may be difficult to see from the outside. It is often located just behind the lip of the white drain pan when the fresh water holding tank is located in the main water compartment. When the fresh water holding tank is located outside of the main water compartment, the fresh water tank low point drain is typically near it.
9	Hot and Cold Low Point Drains	Typically the coach has one hot water low point drain and one cold water low point drain, which are used to empty the water lines. Open the valves to relieve water pressure and drain the water lines. Close the valves for normal operation of the pressurized water system.
10	LED Light Strip	Some lights are operated automatically via a plunger switch that activates the lights when the compartment door is opened.
11	Oasis Heat Exchanger	The Oasis heat exchanger is used to heat the water compartment in order to keep the bay temperature above freezing. This exchanger may be located behind a panel or cover and may not be visible from the outside. Note: Power must be supplied to the Oasis system and the system must be turned on via the control panel or SilverLeaf coach management system in order for heat to be provided to the water compartment. Once both conditions are met, the thermistor will turn the heater on once the compartment falls to approximately 40 degrees.

12	Paper Towel Holder	The paper towel holder is designed for a roll of paper towels. Some coaches may be equipped with a removable cover to protect the towels from moisture or water spray.
13	Sani-Con Discharge Hose Shutoff Valve	The Sani-Con small hose shutoff valve is used to shut off the waste flow to the macerator drain hose. This valve can be shut off when using a 4" gravity drain hose and/or to prevent pressure and waste in the small macerator hose when not in use or in the event that it develops a leak. This valve must be open prior to turning on the macerator when emptying the holding tanks via the macerator drain hose. Open the valve all the way by pulling on the T-handle to allow waste to flow through the small macerator hose. Close the valve by pushing on the T-handle.
14	Sani-Con Macerator Discharge Hose	The Sani-Con macerator discharge hose is used to direct the effluent to a sanitary dump station.
15	Sani-Con Waste Disposal Switch	The Sani-Con waste disposal switch is used to turn the coach's macerator on and off. The switch should not be turned on until the small macerator discharge hose is connected to a proper dump station, the small hose shutoff valve is opened, and the black (sewage) or gray (waste) holding tank dump valve is opened.
16	Sewage (Black) Tank	The black tank is generally for sewage waste from the stool. It is typically located between the frame rails in the water compartment. This tank may be located behind a panel or cover and may not be visible from the outside.
17	Sewage (Black) Tank Dump Gate Valve with T-Handle	In conjunction with the sewage holding tank, the sewage tank dump valve provides adequate and safe storage and/or controls the disposal of waste materials. Open the black tank gate valve all the way by pulling on the T-handle. The tank will start to drain to the macerator or drain outlet as soon as the T-handle is pulled. The 4" drain line or macerator hose should be used to direct waste to the dump station for proper disposal.
18	Sewage (Black) Tank Rinse Connection	When draining your sewer tank, attach a water hose to the sewage tank rinse connection. After the tank is drained, leave the gate valve open, and open the water valve to the attached hose, allowing water to spray inside the sewage tank for several minutes to flush and rinse the tank.
19	Sewage (Black) Tank Rinse Low Point Drain	On coaches equipped with sewage tank rinse low point drain(s), turn the tank rinse drain valve to the "open" position to remove pressure and drain the tank rinse line. When finished using the tank rinse, it is recommended to turn off the water supply to the tank rinse connection. Open the valve, and drain off the pressure in the line before disconnecting the water hose.
20	Sewer Hose Hatch (Access Port)	The sewer hose hatch is a removable cover that allows the sewer hose or the small macerator hose to exit through the compartment floor in order to connect to a proper dump station. This allows the compartment baggage door to close without hindrance from the hose. The cover may be threaded or clipped. Note: When routing the sewer or macerator hose through the hatch, do not place on or near the Oasis, generator, or engine exhaust pipes. Otherwise, damage may occur.
21	SilverLeaf HMS404 Tank Monitor Touchscreen Display	The SilverLeaf HMS404 tank monitor display allows the user to operate the water pump or auto fill function, as well as many other features. For more information, refer to the operation and settings outlined in the SilverLeaf Touchscreen Guide specific for the coach model and year. This guide can be located in Newgle.
22	Waste (Gray) Water Tank	The gray water holding tank is typically located in the underbelly of the coach, sometimes on top of the fresh water tank. It is primarily used for the drainage from the kitchen and bath sinks, shower, and the washing machine (if equipped). This tank may be located behind a panel or cover and may not be visible from the outside.
23	Waste (Gray) Water Tank Dump Gate Valve with T-Handle	In conjunction with the gray (waste) water holding tank, the gray (waste) tank dump valve provides adequate and safe storage and/or controls the disposal of waste water. Open the gray (waste) gate valve all the way by pulling on the T-handle. The tank will start to drain to the macerator or drain outlet as soon as the T-handle is pulled. The 4" drain line or macerator hose should be used to direct waste to the dump station for proper disposal. Newmar recommends dumping and flushing the gray (waste) water holding tank after the black (sewage) holding tank.
24	Waste (Gray) Water Tank Rinse Low Point Drain	On coaches equipped with gray (waste) tank rinse low point drain(s), turning the tank rinse drain valve to the "open" position will remove pressure and drain the tank rinse line. When finished using the tank rinse, it is recommended to turn off the water supply to the tank rinse connection. Open the valve, and drain off the pressure in the line before disconnecting the water hose. Note: Not all coaches are equipped with gray tank rinse.
25	Waste (Gray) Water Tank Rinse Connection	When draining your gray (waste) tank, attach a water hose to the gray (waste) tank rinse connection. After the tank is drained, leave the gate valve open, and open the water valve to the attached hose, allowing water to spray inside the sewage tank for several minutes to flush and rinse the tank. Note: Not all coaches are equipped with gray tank rinse.
26	Water Pump with Filter	When not connected to city water, the coach's water pump is used to pump and pressurize water from the fresh tank for distribution through the hot and cold water lines. When activated, the water pump will automatically turn on and off to maintain proper water pressure in the coach.
27	Whole House Water Filter	The whole house water filter system uses a replaceable extruded carbon filter cartridge to remove sediment and certain impurities from the incoming water supply. This filters the fresh water as it is brought in to the coach from the city water connection through the hose or hose reel.
28	Winterizing and Antifreeze Inlet Valves (A and B)	The winterizing valves are only used during the coach winterization process. To determine proper valve positioning throughout the process, follow the posted instructions in the coach water compartment for the A and B valves. These valves may be located outside of the main water compartment on some coaches.

Additional Resources In Newgle

The above definitions are summaries and only explain the basic function and operation of each component. For additional information about these components and the complete operational instructions, please refer to the following list of additional articles in Newgle.

- Auto Fill Overview
- Exterior Shower Overview
- Fresh Water Lines, Low Point Drains, and Plumbing Leaks
- Fresh Water Tank and Drain
- Fresh Water Valves
- Holding Tank Rinse (No Fuss Flush)
- Hose Reel and City Water Connection Overview
- How to Operate the Cargo Lights
- How to Winterize a Coach
- SilverLeaf Tank Monitoring System Operation via Touchscreen Display (Model: HMS404)
- Waste Water Disposal
- Waste Water Holding Tanks
- Water Filter Care and Maintenance
- Water Pump Operation and Basic Troubleshooting

Water Compartment Heating: Oasis Operation via SilverLeaf

Oasis Hydronic Heating Basement Heat Convectors(s)

Coaches with Oasis Hydronic Heating will have a heat exchanger, dual fans, and a designated thermostat. The basement heat is activated by a separate fixed thermostat in the basement area when the compartment temperature falls below approximately 40 degrees Fahrenheit. If this happens, the hot antifreeze solution in the Oasis system will circulate, and the blower will turn on to supply heat in the basement/water compartment area. The Oasis system must be turned on and the fluid must be above the low temperature cutout for heat output.

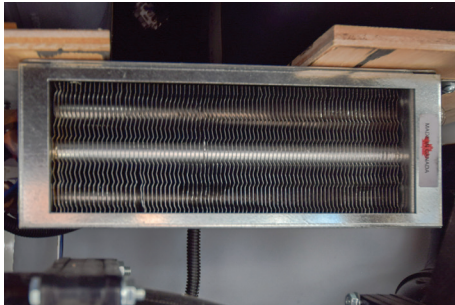

Oasis Basement Heat Exchanger

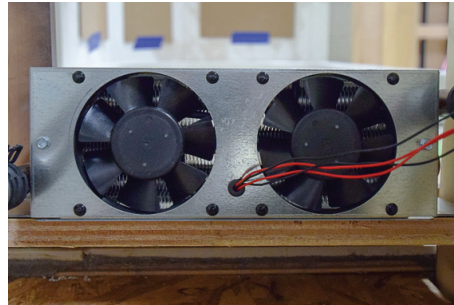

Oasis Dual Fan on Basement Heat Exchanger



Oasis Bi-Metallic Thermostat

Oasis Operation via SilverLeaf

The Oasis System must be turned on from the SilverLeaf touchscreen, and the water temperature in the Oasis System must be up to temperature for the basement heat to work. The basement heat only works when the furnace (Oasis System) is activated. It will NOT function if the Oasis System is off and the coach is being heated via the roof air conditioner heat pumps.

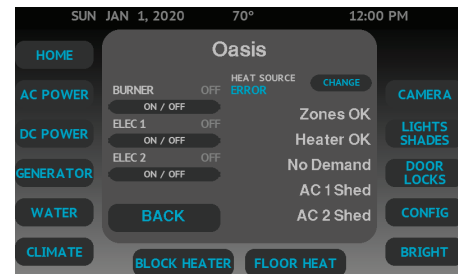

Fresh Water System



The Fresh Water System consists of the fresh water holding tank, water pump, valves, connection hoses, and fresh water plumbing lines. This system is responsible for providing potable water for drinking, cooking, bathing, and all other activities that require clean water. The capacity of your fresh water tank may vary, depending on the coach model and year.

Fresh Water Connection via Hose Reel Overview

This article provides a basic overview of the fresh water connection via a hose reel.

Located in the water compartment, the city water connection is made with a white hose approximately 35 feet in length wrapped on the reel. In conjunction with the “Fresh Water Fill Valve,” this water source is used for a number of purposes, including pressurizing the plumbing in the coach and filling the fresh water tank.

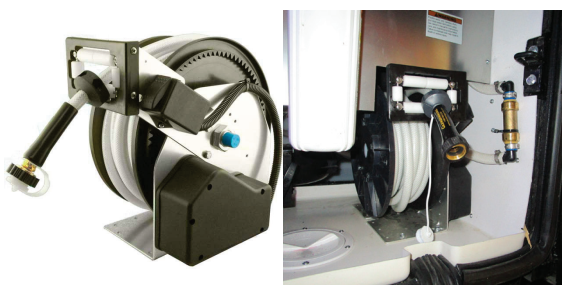

The hose reel deploys manually by pulling the hose outward from the compartment. Once the desired length of hose has been extended, hook up the hose to a potable water source. A switch located on the side of the hose reel requires activation for power retraction. Note: The house battery disconnect must be turned on for the power hose reel to be operated.

The fresh water system in the coach is designed to operate at a maximum of 60 PSI. Water pressure levels above this level can damage the fresh water plumbing in the coach. If the water pressure ever surpasses 60 PSI, a pressure regulator must be installed to reduce the incoming pressure, or fill the fresh water tank and use the internal water pump to supply water to the coach.

Connect the hose from the coach to the city water supply (if equipped with a hose reel). Turn on the supply valve at the water source, and open each of the faucets to remove any air pockets in the coach plumbing lines. Once the water flows freely, close the faucet(s).

To disconnect from the city water supply, close the valve from the water supply. Release the pressure by rotating the fresh water valve to the tank fill position. Remove the hose from the city water supply, and store it in the water compartment. Once the pressure is relieved, rotate the fresh water valve to the appropriate operating position.

Fresh Water Lines and Low Point Drains Overview

This article provides a basic overview of Fresh Water Lines and Low Point Drains.

Fresh Water Lines

Fresh water lines are used to distribute potable water throughout the coach. The hot water lines are typically red in color or translucent with red lettering. The cold water lines are typically blue in color or translucent with blue or black lettering.

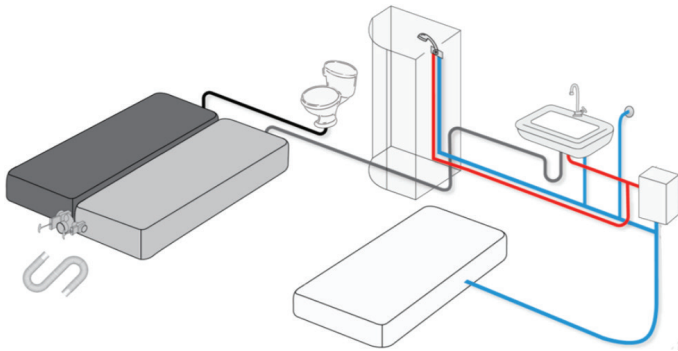

HEATED FRESH WATER LINES

Fresh water lines located beneath the slideout floor are typically heated to prevent freezing (i.e. refrigerator water supply). The water lines are routed in the heated water bay and inside the heated living area as much as possible.

Heated fresh water lines are typically used on floorplans with bath fixtures or a refrigerator containing an ice maker or water dispenser located in a slideout. Heated water lines are used to connect the plumbing from the basement area to the refrigerator where the water lines are exposed under the slideout. The 12 volt power to the heated water line is usually fused in the cord compartment fuse panel in diesel coaches and on the firewall fuse panel on gas coaches.



Some coaches may be equipped with a Manabloc water distribution manifold that allows water to be shutoff to individual water lines. For more information about the Manabloc, refer to Newgle.



Some coaches may incorporate inline water valves on some water lines which may include the water spigot to the generator area or other non-heated compartment bays, ice maker water lines, and/or inline water filters. The valve(s) could be located various places depending on the coach year, model, and floorplan (i.e. under the kitchen sink, under the dinette booth, in the false pantry floor bottom, under the couch, or in the basement).

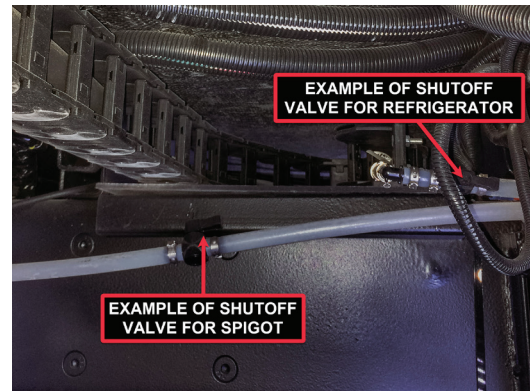

FRESH WATER LINES TO THE KITCHEN

The hot and cold plumbing lines connecting slideout-installed components, such as the kitchen sink and other optional equipment utilizing the coach water supply, are typically hard-plumbed within the slideout.

To ensure flexibility, a braided hose connects the rigid plumbing from within the slideout to the rest of the plumbing in the coach. This hose easily moves with the slideout as it extends and retracts. The plumbing lines are normally tied to the flexible drain pipe and extend and retract smoothly as the slideout travels.



Hot and Cold Low Point Drains

Low point drains are normally located in the water compartment and are marked “Low Point Drains.” Some valves are mounted in the water control panel and others are placed close to the water compartment and marked with a sticker nearby. Typically the coach has one hot water low point drain and one cold water low point drain, which are used to empty the water lines. Open the valves to relieve water pressure and drain the water lines. Close the valves for normal operation of the pressurized water system.

LOW POINT DRAIN CONFIGURATION EXAMPLES

On coaches equipped with tank rinse low point drain(s), turning the tank rinse drain valve to the “open” position will remove pressure and drain the tank rinse line. When finished using the tank rinse, it is recommended to turn off the water supply to the tank rinse connection. Open the valve, and drain off the pressure in the line before disconnecting the water hose.



Low Point Drain Configuration Examples

Fresh Water Tank and Drain

This article provides a basic overview of the fresh water tank and drain. This tank is used to hold fresh potable water for use throughout the water system and is usually located on the floor of the water compartment; however, some coach floorplans may be equipped with a water tank located in another compartment. The fresh water tank is filled from the city water hook-up with a hose or hose reel.

⚠ WARNING

Potable water only. Sanitize, flush, and drain water tank before using. See owner's manual for instructions, care, and maintenance information. Failure to maintain tank can result in death or serious injury.

AD-04



The fresh water fill valve located in the service compartment near the water hook-up determines whether the city water is going through the water system or into the fresh water tank. The excess water will be vented from an overflow vent pipe onto the ground when the tank capacity has been reached. This pipe is installed in the fresh water tank to prevent tank rupture from overfilling.

Preventing, Stopping, and Repairing Plumbing Leaks

⚠ IMPORTANT

In the event of a water leak, immediately shut off the water pump and/or disconnect the coach from the pressurized water source. Open the low point drains in the water compartment. This will relieve pressure and allow time to locate the leak and/or a shutoff valve (if the coach is equipped).

Poor or improper winterization may cause leaks, and/or vibration and flexing during travel can cause pipes and fittings to work loose. Follow this checklist to prevent or repair any plumbing leaks:

- Check all of the plumbing connections for leaks on a yearly basis.
- If the water pump runs when all faucets are turned off, check for a leak.
- Be sure the drain valves are closed.
- Tighten any loose faucet connections with a wrench.
- Disconnect the leaking connections completely, and check for mineral deposits or foreign material on the sealing surfaces. Clean the surfaces thoroughly, and reinstall the fitting.

⚠ IMPORTANT

Plumbing repairs should be performed by an authorized service center, followed by a pressure test.

Fresh water tank drains are located a few inches in front of or beside the fresh water tank and are connected to the fresh water tank with a 1/2” or 1” water line.

Whenever possible, drain the fresh water tank before traveling or only carry what you will need to get to your destination. Water in the tank will reduce the carrying capacity of the coach. All of the water should be drained from the fresh water system when the coach is not in use for more than one week to prevent stagnant water and reduce organic growth. To drain the fresh water tank, open the low point drain valve located near the fresh water tank.

FRESH WATER TANK DRAIN CONFIGURATION EXAMPLES

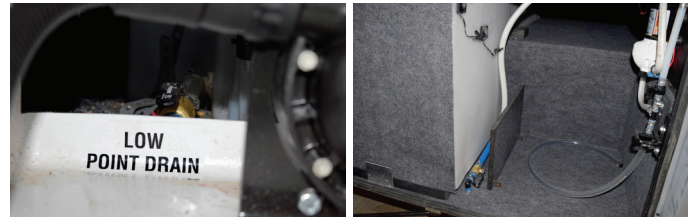

Fresh Water Valves

The article provides a basic overview for the Fresh Water Valves in a coach. The rotating “Fresh Water Valve” located in the water compartment is used to pressurize the fresh water system in your coach, as well as to fill the fresh water tank when the coach is connected to city water.

The Fresh Water Valve position determines whether the water supply fills the tank or pressurizes the fresh water system in the coach. Simply rotate the “Fresh Water Valve” to the appropriate position to perform the desired function.

⚠ IMPORTANT

If you leave this valve in the manual tank fill position, you may experience low water pressure while operating the water pump.

FRESH WATER VALVE EXAMPLES



Auto Fill

For coaches equipped with an Auto Fill function, the coach must be connected to a pressurized water source and have the Fresh Water Valve in the “Auto Fill” position. In addition to turning the valve, the coach must also have the Auto Fill function enabled within the tank monitoring system. This function is used to automatically fill the fresh water tank and shut off the water supply based on the tank levels. The system will turn on the Auto Fill valve when necessary and turn it off when the tank reaches capacity.

Both the Precision Circuit Digi-level and the KIB TMSC-100 systems control the electric auto fill valve via the monitor panel in an overhead panel and are fused in the 12 volt house fuse panel. The KIB TMSC-100 system’s circuit board is typically located in the shore cord compartment, and the Digi-Level does not use a separate circuit board.

The SilverLeaf system allows the Auto Fill feature to be activated via the touchscreen or the SPX-300 panel located in the water compartment. It is controlled by the TM102 module and uses the fuse panel and relay board typically located in the shore cord compartment. For more information about the coach’s tank monitoring system, refer to the sub-category within the Electronics section.

City Water Connection

Before connecting to your coach, use a potable water source to purge any remaining air and stale water in the hose. Then, connect the hose from the potable water source to your coach or the hose from your coach to the city water supply (if equipped with a hose reel). Turn on the supply valve at the water source, and open each of the faucets to remove any air pockets in the coach plumbing lines. Once the water flows freely, close the faucet(s).

FRESH WATER CONNECTION
AD-16

CITY WATER CONNECTION
AD-14

Water Pump

The water pump is used to pressurize the fresh water system when the unit is not connected to city water. The city water supply is under pressure, so the water pump is not necessary while you are connected to city water. Once the city water fill valve is not in the manual fill position, the water is supplied to the fresh water system components, including the hot water heater and faucets.

To disconnect from the city water supply, close the valve from the water supply. Release the pressure by rotating the fresh water valve to the tank fill position. Remove the hose from the city water supply, and store it in the water compartment. Once the pressure is relieved, rotate the fresh water valved to the appropriate operating position.

⚠ IMPORTANT

Use a water hose manufactured and labeled for potable water to ensure that the hose is drinking water-safe and will not alter the taste of the water.

Auto Fill via SilverLeaf

This article provides a brief overview of the fresh water auto fill function. If a coach is equipped with the Auto Fill function, it is used to automatically fill the fresh water tank and shut off the water supply to the fresh water tank. The system will turn on the Auto Fill valve when necessary and turn it off when the tank reaches capacity.

Auto Fill Valve and Pressurized Water Supply

On coaches equipped with an Auto Fill valve, it is usually located in the water compartment and may be hidden by the hose reel and is operated by the Tank Monitoring System. The valve is a 12 volt-operated solenoid valve that allows water to pass through from the inlet to the outlet when energized.

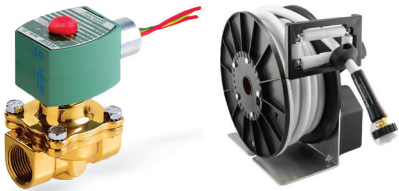

For the Auto Fill feature to work properly, the coach must meet the following requirements:

1. The coach must be connected to a pressurized water supply. Pressurized water can be sourced by any potable supply, including a municipal water supply or a private well. This is normally a garden hose connection from the RV park, house, or exterior hydrant. The pressurized water supply should be regulated at 60 PSI or less.
2. The Auto Fill feature must be enabled within the tank monitoring system.
3. The Fresh Water Tank fill valve must be in the position noted for Auto Fill.

Tank Monitoring System Auto Fill

AUTO FILL VIA SILVERLEAF

The Auto Fill button turns the fresh water tank Auto Fill functions on and off. The display will read ON, OFF, or FILLING. This function will allow the fresh tank to automatically fill with water based on the parameters set in the auto fill advanced configuration screen. The Auto Fill will begin at 90 percent and stop when it reaches 100 percent, as set at the Newmar factory.

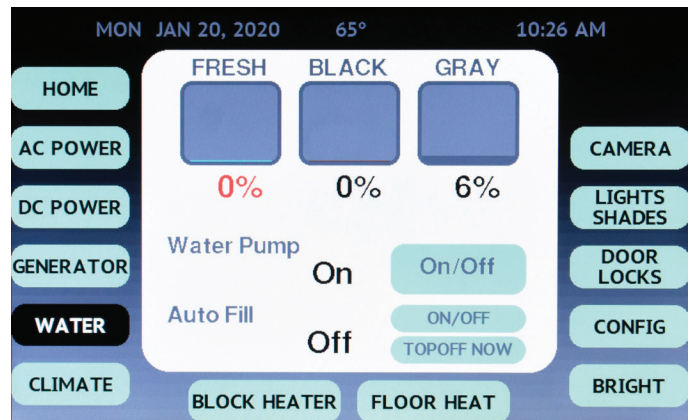

Aqua View Fresh Water Reclamation System (Shower Mi\$er)

2023 Mountain Aire Aqua View Fresh Water Reclamation System Overview

This article provides basic operation instructions for an Aqua View (SinkMi\$er, ShowerMi\$er) Fresh Water Reclamation System as it is installed in 2023 Mountain Aire coaches.

How the Fresh Water Reclamation System Works

Coaches equipped with an Aqua Miser Fresh Water Reclamation System have the ability to conserve water and grey tank capacity. This system is especially useful when dry camping.

By using water in the system supplied by the pump or pressurized water from a city water connection, this

system allows you to redirect or recycle the cold water back into the fresh water tank before it comes out of the shower head. This water would normally go down the drain, filling up the gray water tank and wasting the fresh water supply. Once the water is warm, the system's LED indicator light will let the user know when it is time to adjust the diverter in order to allow water to freely flow from the shower.

If you use the diverter valve to stop water flow during the shower once the indicator light turns red, you are diverting hot water to the fresh tank. If the coach is connected to a pressurized water source while the diverter valve is in the recycle position, this may cause the fresh water tank to overflow.

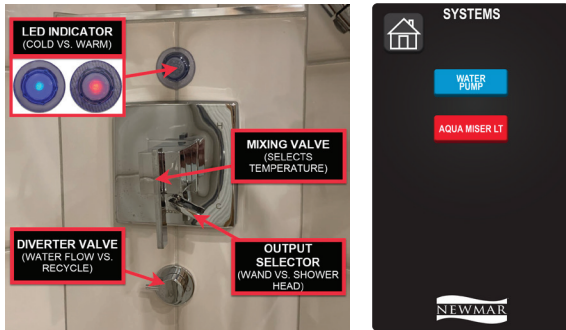

2. Place the Aqua Miser lever in the “recycle” position. This will divert the water back to the fresh tank instead of wasting the water and filling the grey tank. The blue LED light will turn off and the red LED will turn on when the water gets hot.
3. When the light turns red, the system is ready for final shower temperature adjustments to be made. Turn the diverter valve back to the water flow position.
4. Turn the shower mixing valve (rotating knob on the right side of the shower pipe) until the desired temperature has been reached.
5. Use the output selector (small lever at the bottom of the faucet) to select the preferred water output, such as the shower head or the hose wand.

Aqua View and Auto Fill



NOTE FROM NEWMAR

Over the past several years, Newmar has used several different types and styles of Aqua View systems. The exact system setup will vary by year, model, floorplan, and faucet style. The following information is based on 2023 Mountain Aire coaches.

Aqua View Operation

To shower while dry camping, follow these steps:

1. Press the Aqua Miser LT button on the LCD touchscreen. The LED indicator light will turn blue inside the translucent mushroom cover when the water temperature is cold.



⚠ IMPORTANT

If left in the diverted/recycle position while the coach is connected to city water, the Aqua Miser system will continue to add water to the tank if the fresh water fill valve in the water compartment is turned to the auto fill or auto city supply position. Adding water to the fresh tank in this manner is unregulated and may cause the fresh tank to overflow, which may make the auto fill system appear as though it is malfunctioning.

Winterizing the Aqua View Fresh Water Reclamation System

This article provides additional winterization instructions relevant to coaches equipped with an Aqua View Shower Miser Fresh Water Reclamation System. This information should be used in conjunction with the coach winterization process as written in Newgle.

- Cycle the valve to the recirculate position to purge the water out of the line back to the fresh water tank while pressurized air supply is connected.
- Place the valve back to normal flow mode to the shower head.
- Then purge the shower.
- Run RV antifreeze through the shower system.

⚠ IMPORTANT

Do not leave the valve in bypass mode when running antifreeze in the line because it will allow antifreeze into the fresh tank.

NOTICE

Ensure shower miser valve is not set to recirculate to potable water tank before winterizing

Domestic Hot Water via Hydronic Heating

This article provides a basic overview of domestic hot water via the Oasis hydronic heating system.

The hot water in your coach is heated by the Oasis hydronic heating system. To operate an appliance that uses hot water, or to assure plenty of hot water for showering, turn on the boiler or heating elements using the Oasis control panel or the SilverLeaf touchscreen (if equipped) located in the front overhead cabinet.

Both heat sources (diesel burner and heating elements) can be used at the same time for the maximum water heating capability. Turning only the 120 volt heating element(s) on will usually provide sufficient hot water for most household chores, but may not be sufficient for showering.

The diesel burner is the primary heat source with at least 50,000 btu (more on select Oasis models), and the electric elements are secondary. Depending on your hot water usage, using only the electric elements may be sufficient; however, if not, use the diesel burner when not plugged into shore power or in conjunction with the electric elements.



Potable Hot Water Capacity

	CH50	NE-S	CHINOOK
BTU	50,000	85,000	50,000
Maximum Water Temperature (at incoming water temperature of 60°F)	120°F	120°F	120°F
Gallons Per Minute (GPM)	1.5	3.0	1.5



Water Pumps and Controllers

Water Pump Operation and Basic Troubleshooting

The water pump is self-priming and totally automatic, operating on demand whenever water is required. When not connected to city water, the coach's water pump is used to pump and pressurize water from the fresh tank for distribution through the hot and cold water lines.

When the water pump switch is turned on, the water pump builds pressure in the system and will shut off as soon as the system is correctly pressurized. When a faucet is opened, the pump will turn on and operate as necessary to maintain the preset pressure in the system. Water pump operation is not necessary while the coach is connected to city water, since the potable water is already pressurized.

When using water at a low flow rate (GPM), the pump may pressurize the system and short cycle, meaning the pump shuts on and off quickly. In many cases, the pump will stop short cycling if the flow rate of the water is increased.

Operation

1. Fill or partially fill the fresh water supply tank.
2. Open the kitchen and bathroom faucets.
3. Turn the water pump switch on, and allow the water to fill the water line and the hot water heater. The switch to this pump may be located in the exterior water compartment, in the kitchen, or in the bathroom.

4. Close each faucet after it delivers a steady stream of water (close the cold water first). Leave the hot water faucets on until they also deliver a steady stream of water. This will ensure that the water heater is filled with water.
5. The water pump should stop running once all faucets are closed.
6. The pump is now ready for automatic operation. The pump will run when a faucet is opened and stop when a faucet is closed and the correct pressure has been reached.

⚠ CAUTION

Never allow the pump to run for long periods of time without water in the supply tank, as pump damage or blown fuses may result.

Care and Maintenance

All of the water should be drained from the fresh water system when the unit is not in use for more than one week.

Troubleshooting

If water doesn't flow when a faucet is turned on while using the demand system, use the following troubleshooting tips.

If the pump is running, but there is no water:

- Fill the tank.
- Clear the water line to the pump or the pump inlet filter.
- Rotate the city water / tank fill valve to the correct position.

If the pump isn't running:

- Check the pump switch.
- Check the 12 Volt fuses.
- Check the electrical connections.
- Check the battery.

Water Pump Operation via SilverLeaf HMS710 Touchscreen Display, HMS404 Tank Monitor, and KIB LCD Touchscreen

This article provides a basic overview of the water pump operation via the SilverLeaf HMS710 touchscreen, HMS404 tank monitor, or the KIB touchscreen. The water pump may be operated from one or multiple locations, depending on the coach model, year, and floorplan.

Silverleaf HMS710 Touchscreen

The SilverLeaf TM-102 module receives inputs from the water pump button or switch on the SilverLeaf touchscreen panel, the remote monitor panel in the water compartment, or the KIB V-BUS switch panel(s) (if equipped). By activating the water pump button or switch, the TM-102 energizes the water pump relay in the KIB circuit board, which grounds the circuit. Once the pump pressure switch makes contact, the pump will supply water pressure to the fresh water system. The pump will shut off once the pump pressure switch is satisfied.

The water pump button turns the water pump on and off to direct water from the fresh tank through the coach's plumbing system. The display will read ON or OFF. This touchscreen may be located in the overhead control panel, bedroom, or in the middle of the coach on the wall.



HMS404 Tank Monitor

Press the Water button to view the Water page in order to turn the water pump or the auto fill function to ON, OFF, or TOP OFF. This monitor is typically located in the exterior water compartment.

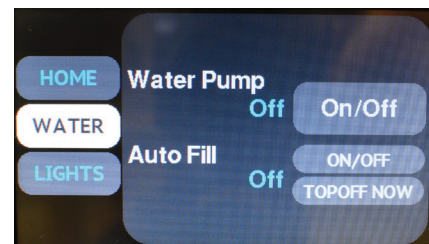

KIB LCD Touchscreen

Touch the SYSTEMS button. Then select the Water Pump button. Once a button is touched, it will turn red, indicating the selected system is active. The buttons are gray while the system is inactive. There are typically several touchscreens located in various locations throughout the coach and may be used in conjunction with the SilverLeaf system.

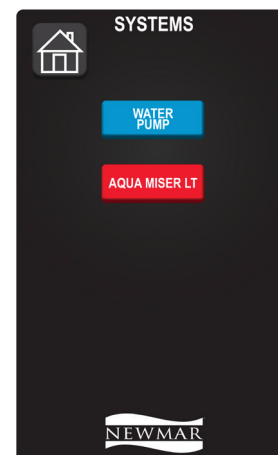



Faucets and Fixtures

Your installed bathroom and kitchen faucets and fixtures are available in many styles, finishes, and configurations, often complementing the other fixtures in your coach.

With proper maintenance, the faucets in the coach should provide years of trouble-free usage. The faucets and fixtures can be cleaned by wiping with a soft, damp cloth. Washing with warm water will remove dry water spots. Turn off the water and drain the pressure before attempting repair or replacement of the faucet.

⚠ **IMPORTANT**

Avoid using “S.O.S.” type cleaning pads or other abrasive cleaners because they may scratch the surface. Do not use cleaners that contain harsh or abrasive chemicals. Alcohol or similar solvents should never be used.

Hot Water Spout in the Front Generator Slideout Overview

This article provides an operational overview of the hot water spout in the front generator slideout. This spout may be standard equipment on most diesel pushers and optional on other diesel pushers.

To use the hot water spigot in the front generator area:

1. Make sure the fresh water tank has water in it. Make sure the water pump is turned on or the coach is connected to a pressurized potable water source.
2. Turn off the low point drain near the spigot (if in the open position), and turn on the valve in the lower compartment area (typically located near the frame rail).
3. Hook up a garden hose, and use the water as desired.
4. If you exceed the gallons per minute (GPM) rating of the hydronic heater, you will run out of hot water until the system has enough time to recoup and heat more water.
5. Do not forget to winterize this line while following the directions in Newgle for winterizing the coach.
6. Once you have completed the winterizing procedure, you may close the valve in the lower compartment and open the low point drain near the hot water spout to relieve pressure to ensure it cannot freeze.

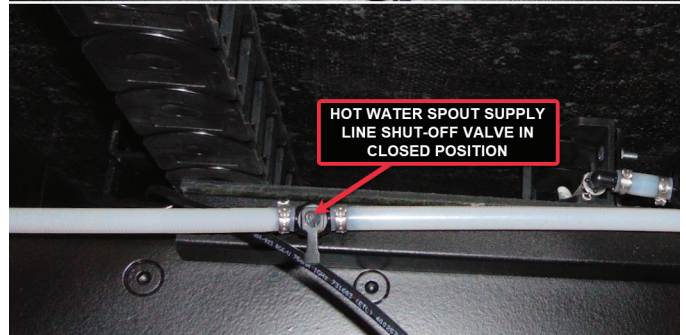
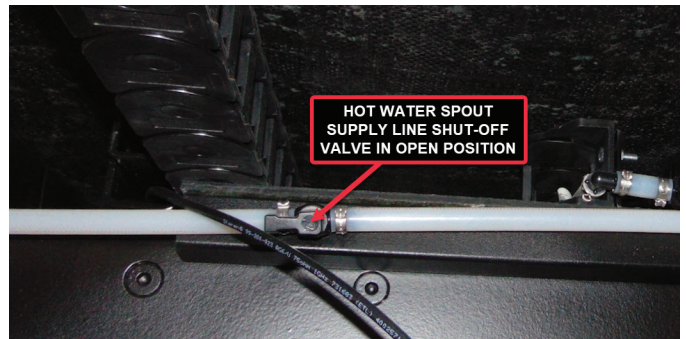
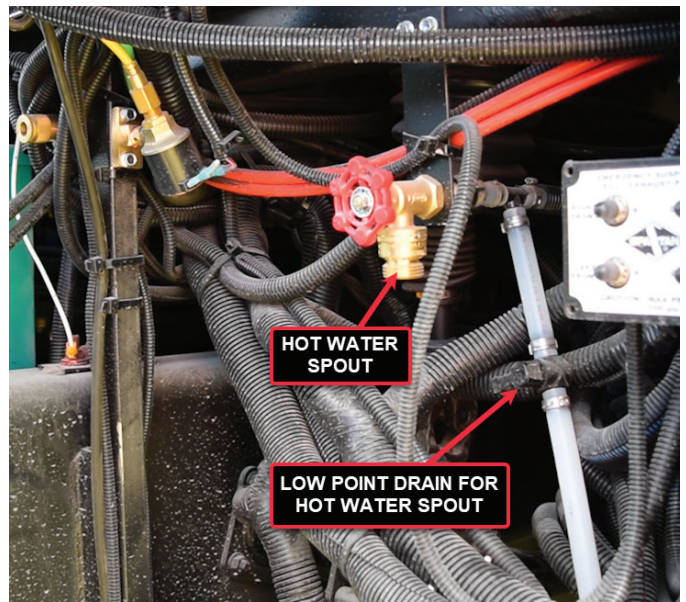



Filters

Water Filter Care and Maintenance

This article provides basic care and maintenance recommendations for water filters. Your coach may be equipped with a fresh water filtration system. This system uses extruded carbon filter cartridges to remove sediment and certain impurities from the incoming water supply. The filter assembly is located in the basement water compartment. Select coach models may also have additional filters installed for drinking water.

When To Replace Your Filters

Most water filter manufacturers recommend that you replace your water filters every six months. These guidelines are based more on average household size and average consumption rates rather than your specific coach. The frequency of filter changes depends upon your water usage and the quality of water you are using. As you travel and hook up to different water sources some may contain more sediment, metals, sulfur and other impurities which affect the filter life, the taste and

smell of your water. Other factors are how often it is used and stored and how long water is able to sit in the holding tank and become warm and stagnate.

Change the filter at least every six months and at any time you notice decreased water flow or notice unpleasant taste, odor, or algae after flushing and sanitizing the water system. Water filters and fresh water system maintenance are the customer's responsibility in order to ensure safe potable water.

Flow-Pur Whole House Water Filters

This article provides basic instructions for replacing a Flow-Pur Whole House Water Filter. Replacement filter cartridges are available through the Newmar parts department. For parts inquiries, refer to the NewPar (formerly ComNet) parts catalog or contact the parts department at 1-800-731-8300 (option #1).

1. To replace the filter cartridge, turn off the water supply to the coach at the city water connection, or turn off the water pump if using potable water.
2. Drain the water pressure off the system by opening a faucet or low point drain, and press the red button on top of the filter housing.
3. Unscrew the filter canister by rotating to loosen and remove it (the top housing has male right hand threads, and the canister portion has female threads).
4. Insert the new filter cartridge, positioning it so the opening in the bottom of the filter is placed on the molded ring at the bottom of the canister.



CAUTION

When replacing the filter, make sure the rubber O-Ring seal is properly positioned in its groove in the cartridge housing. An improperly positioned or missing seal will cause leakage around the perimeter of the filter housing.

5. Reattach the canister to the filter housing by rotating the canister until it tight. Do not over tighten the canister when attaching it back to the housing.

IMPORTANT

Do not allow water to freeze in the water filter canister. Freezing will crack and permanently damage the filter housing and associated plumbing. Always remove the filter cartridge prior to winterization.



Power Washers, Sprayers, and Exterior Showers

Exterior Shower Overview

An exterior shower located in the water compartment on the driver side may be an optional feature on your coach and can be used to rinse off sand or grass, muddy shoes, or bathe a pet outside of the coach. The exterior shower may also be used to wash your hands or rinse off the sewer hose after dumping the waste water tanks.

The faucet operates just as it would in the kitchen or bathroom. When finished using the exterior shower, shut off both the hot and cold valves. Do not simply shut off the valve on the shower head itself, as it may cause hot and cold water to mix at the exterior shower and could allow drastic changes in water temperature throughout the coach.



Waste Water System

There are two separate waste systems: the gray tank system and the black tank system. Each tank has its own control valve, and both tanks drain through the sewer drain hose.



Sinks, Tubs, and Showers

This article provides an overview and care and maintenance recommendations for sinks, tubs, and showers. The sink and shower are the beginning of the waste water system. The basic purpose is to contain the used water so it can be drained via the attached waste water drain line to the holding tank.

Care and Maintenance

The maintenance requirements for sinks and the shower are on an as-needed basis. Occasionally, the attached drain and trap may need to be cleaned of soap scum and hair to maintain efficient drainage. The basins and shower walls can be cleaned to maintain the original luster. Clean the entire surface, including the exterior, of the lavatory and kitchen sinks and shower with mild soap and warm water. Wipe the entire surface completely dry with a clean, soft cloth.

⚠ IMPORTANT

Avoid using “S.O.S.” type cleaning pads or other abrasive cleaners because they may scratch the surface. Do not use cleaners that contain harsh or abrasive chemicals. Alcohol or similar solvents should never be used.

Follow these tips to maintain the shower(s) in the coach:

1. Make sure the shower doors are closed and latched or locked prior to travel.
2. Check for leaks in the shower seals. Reseal them as needed.
3. Using a mild detergent and a soft cloth, wipe down the shower walls and glass enclosures after each use to avoid soap scum and hard water deposits.
4. When winterizing the coach, clean up any remaining antifreeze in the shower, as it may cause staining.

Waste Water Drain Lines

The drain lines are plumbed from the sinks, showers, and toilets are sloped to drain waste water to the grey or black tank. However, if the coach is equipped with a lift pump, refer to the “Lift Pump” article. If the coach is equipped with macerator toilet(s), refer to the toilet article(s).

The drain lines connecting slideout-installed components, such as the kitchen sink and other optional equipment utilizing the coach water supply, are typically hard-plumbed within the slideout. The hard plumbing from the kitchen slideout connects to the hard plumbing from the tank using a braided drain line to ensure flexibility as the slideout extends and retracts. The fresh water plumbing lines are normally tied to the flexible drain pipe and extend and retract smoothly as the slideout travels.

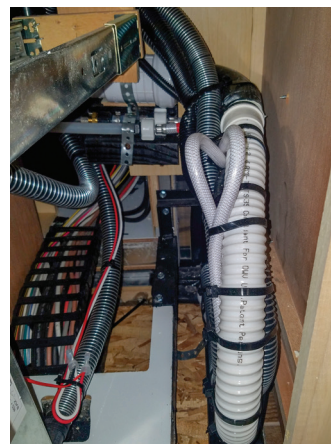

P-Traps and Waterless Traps

This article provides an overview and care and maintenance recommendations for traditional and waterless p-traps.

P-Traps

The sinks and shower drain have a water trap to prevent holding tank odors from entering the coach. These traps must have water in them in order to trap the odors. While traveling, the water may leave the P-Trap. While stored, the water may evaporate, allowing an odor to enter the coach. If this occurs, run water from the faucet into the drain, allowing water to fill the trap.

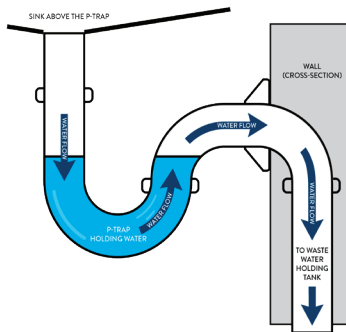

Waterless Traps

Some coach models with a rear shower may have waterless traps in lieu of conventional P-traps. Waterless traps are designed to allow water to drain and to prevent odor from entering the coach without the height requirements of the conventional p-trap. Pressure builds and the self-sealing valve opens as water drains from a fixture. The valve closes to form a tight seal after the water has completely drained from the sink or shower. No routine or seasonal maintenance is required for the waterless trap.

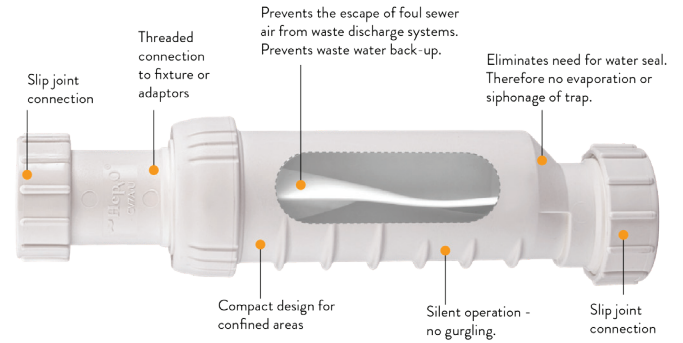

NOTICE
Remove the waterless trap before using mechanical drain-cleaning devices. Waterless trap can be damaged.
AD-123

Foreign objects, such as hair, in the trap may allow odor to enter the coach and impede or slow water drainage and require occasional cleaning. When removing the waterless trap for cleaning, the ridges must be down and the direction of water flow must be correct when re-installed.

IMPORTANT
If standing water occurs in your shower, do not attempt to unplug or open the drain with a coat hanger or a sewer snake. Before taking your coach to a service center, try leveling your coach so that the rear is raised slightly higher than the front. This may correct the condition and prevent drain-cleaning or a service repair. If this does not correct the issue, Newmar recommends taking your coach to a service center for drain-cleaning or repair.

Shower Dispenser Overview

This article provides basic operation instructions for a Shower Dispenser (Soap, Shampoo, Conditioner, Body Wash).

Filling Chambers and Priming Pumps



1. Only after the silicone is fully cured can the mounting bracket support the weight of the liquids. Fill the chamber(s) with your choice of liquid(s).
2. Prime the pump(s).
 - a. Push button in.
 - b. While holding the pump button in, place your finger over the spout of the pump to block the airflow up into the pump. This creates a partial vacuum in the pump chamber, when the button is released.
 - c. Keep your finger over the spout and release the pump button.
 - d. Remove your finger from the spout and repeat these steps until you have a continuous flow of liquid. This may take several cycles, especially when using very thick liquids.

Maintenance

Bathroom cleaners can often contain aggressive chemicals and abrasives, designed to clean ceramic and porcelain surfaces. These cleaners are likely to damage, deteriorate or discolor the dispenser.

Before using any cleaner, read the list of ingredients on the label. The best method for cleaning the dispenser is with a soft damp cloth.

Source(s): *The Dispenser Soap and Shampoo Owner's Manual*

Product(s): *This source is associated with more than one product. Refer to Newgle for more information about the product(s) offered for your coach's model year.*



Toilets

Toilet Overview, Care, and Maintenance

This article provides an overview of toilet operation and care and maintenance. “Go” in style and comfort, no matter where your travels may take you.

Waste Water Drain Lines

The drain lines are plumbed from the sinks, showers, and toilets are sloped to drain waste water to the grey or black tank.

Care and Maintenance

Before using the stool, treat the tank with water that is mixed with an odor-controlling chemical, which is readily available at any RV supply store. Mix as directed on the holding tank chemical package. After mixing and flushing the chemical mixture, the waste tank is ready for use. The stool should be cleaned regularly for maximum sanitation and operational efficiency.

⚠ IMPORTANT

Be careful not to spill the chemical on your hands, clothing, or the carpet, as it may cause a permanent stain.

⚠ CAUTION

Use only approved RV odor controlling chemicals in the holding tanks. Do not use chlorine or caustic chemicals like laundry bleach or drain-opening chemicals, as they will damage the seals in the toilet and dump valves. Products containing ammonia and petroleum may damage the ABS plastic holding tanks and seals.

When using your stool, it is wise to fill the bowl 3/4 full of water. This will help to wash the solids away from directly below the stool and to ensure complete dumping of the holding tank. After flushing, a small amount of water should remain in the bowl.

Dometic Macerator-Style Toilets with Flush Handle or Switch Operation (Model: 8700 Series)

This article provides basic operation instructions for a Dometic Macerator-Style Toilet with Flush Handle or Switch (Model: 8700 Series).

The Dometic 8700 series MasterFlush toilet provides an electric-flush toilet that macerates waste and pumps it to a holding tank or other effluent storage/disposal system using an inline macerator hidden in the base of the toilet.

Operated by a wall-mounted flush switch or electronic flush handle, the toilet allows the user to add water to the bowl (before using or flushing) and to flush the toilet by pushing a button. The Dometic flush switch panel includes

⚠ IMPORTANT

Before adding water, consult the toilet manufacturer’s owner’s manual for the specific procedure relating to your system.

⚠ NOTICE

Residual water trickle in ceramic bowls: Due to integrated rim of this toilet bowl, water may continue to slowly trickle into toilet bowl for up to 20 minutes after flushing. If water trickle continues after 30 minutes, replace the water valve.

⚠ NOTICE

To prevent holding tank odors from entering the living space, make sure a small amount of water remains in the toilet bowl.

⚠ WARNING

Do not flush diaper wipes, feminine hygiene products, or any other products that would not be easily liquefied. Also avoid using holding tank deodorant capsules, as they may cause damage to the macerator. Damage resulting from flushing any materials or objects other than organic waste and toilet paper are not warrantable repairs.

lights to indicate when electric power to the toilet is activated, and when the holding tank (if applicable) is full. For information regarding the motion-sensor (hand wave) switch panel installed on some Dometic 8000 and 9000 series toilets, refer to the Electronic Flush Switch Panel article in Newgle.



Dometic macerator toilets use a Dometic control module and a wall-mounted flush switch, which can be located in a basement compartment, cabinet, or on the floor (behind the toilet). The module will be located no more than 6 feet from the toilet. The module has power, ground, two tank level warning wires, and a communication cable.

Adding Water To The Toilet Bowl

Press the “Add Water” switch until the desired water level is achieved. The water flow will shut off automatically if switch is pressed too long to avoid overflow. More water is usually added only when flushing solids.

Flushing The Toilet

Press “Flush” switch, then release it. This activates a powerful macerator pump that siphons water and waste from the bowl, macerates, and propels the effluent through the discharge line to the holding tank.

Changing Flush Modes

Dometic 8700 series MasterFlush toilets offer two flush settings to help manage water consumption:

1. Normal Flush: Uses 0.85 gallons per flush and adds water to bowl after ever flush.
2. Dry Bowl Flush: Uses 0.45 gallons per flush and does not add water to bowl after flush.

To change from Normal to Dry Bowl flush setting, press the “Flush” switch for about five seconds. When the “Power On” light begins flashing, release “Flush” switch. The flush mode has been changed to Dry Bowl setting. Change the mode to Normal flush by following the same procedure.

Indicator Lights

- “Power On” Indicator: On the Dometic flush switch panel, as steady green “Power On” light indicates when electrical power to the toilet is activated. A momentary flashing green light indicates when flush mode is changing.
- Tank Level Indicator: The flush switch panel includes a bi-color “3/4 Full” (amber) and “Full” (red) Tank Level light to indicate when the holding tank is approximately 75% or 100% full and should be pumped out. When the red light is illuminated, electrical power to the toilet automatically shuts off to prevent overflow of the holding tank.

*Source(s): Dometic 8700 Series MasterFlush Macerator Toilet Operation Manual
Product(s): This source is associated with more than one product. Refer to Newgle for more information about the product(s) offered for your coach's model year.*

Waste Water Holding Tanks

This article provides a basic overview of the waste water holding tanks. There are two separate waste systems: the gray tank system and the black tank system. Each tank has its own control valve, and both tanks drain through the sewer drain hose.



The waste drainage system was designed to provide adequate and safe storage and/or disposal of waste materials. The drainage system uses plastic piping and fittings connected to the sinks, toilet, and holding tanks to provide for their drainage to an outside termination. All waste water tanks are vented through the roof and covered with a vent cap. The coach should be reasonably level for best operation of the system.



Some coaches not equipped with Oasis Hydronic Heating may have optional tank heating pads to reduce the risk of tank contents freezing.

Gray Water Holding Tank

The gray water holding tank is located in the underbelly of the coach, sometimes on top of the fresh water tank. It is primarily used for the drainage from the kitchen and bath sinks, shower, and the washing machine (if equipped).

CAUTION

The gray tank valve must be in the open position when operating the optional washing machine.

Black Water Holding Tank(s)

The black water holding tank(s) are generally for sewage waste from the stool. It is typically located between the frame rails in the water compartment directly beneath standard flushing toilets. Macerator-style toilets can be installed away from the black tank.

During normal use, tank buildup may occur on the inside of the tank. How quickly buildup occurs varies from user to user and is affected by many factors such as water hardness, the amount of solid waste, how easily the toilet paper breaks down, how often the tank is dumped, and how well the tank is flushed. When buildup occurs, it may impair the tank sensor’s ability to read tank levels properly. Preventive tank maintenance is recommended.

The gray and black tank(s) should be rinsed after dumping and treated with a waste tank additive to help break down and liquefy solid waste and help reduce odors. This chemical is readily available at any RV supply store. Add tank chemicals and the amount of water recommended by the chemical manufacturer. If the coach is equipped with two black tanks, add the chemicals to both toilets.

⚠ IMPORTANT

Be careful not to spill the chemical on your hands, clothing, or the carpet as it may cause a permanent stain.

⚠ CAUTION

Use only approved RV odor-controlling chemicals in the holding tanks. Products containing ammonia and petroleum will damage the ABS plastic holding tanks and seals.

Waste Water Disposal

This article provides basic instructions for draining the waste water holding tanks.

Both of the holding tanks terminate in a valve arrangement that permits draining each tank separately or together. The valves that open to release the water are called gate valves. The blade that closed the opening in the sewer drain pipes is connected to the T-handle to release the contents of the tank(s) when pulled.

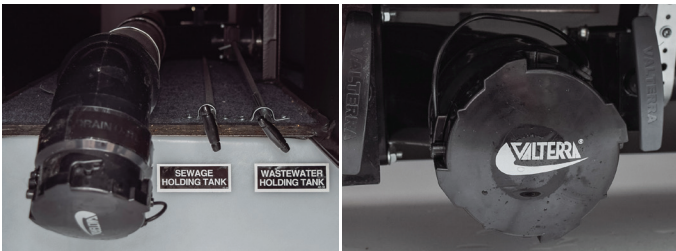

The sewer line must be securely capped during self-containment use to prevent leakage of waste material onto the ground or pavement.

⚠ CAUTION
 Keep drain valve closed to minimize the presence of sewer gases. Sewer gases can be present when RV is connected to campground sewage hookup. Can lead to illness or personal injury.
 AD-120

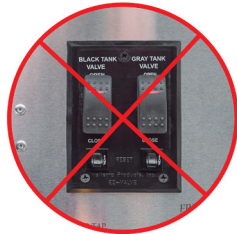

Do not pull the holding tank gate valve open, or operate the electric dump valve switch (if equipped) when the protective cap is installed on the pipe. Always drain the tank into an acceptable sewer inlet or dump station.

⚠ WARNING

Holding tanks are an enclosed sewer system and must be drained into an approved dump station. Both black and gray water holding tanks must be drained and rinsed thoroughly on a regular basis in order to prevent the accumulation of harmful or toxic materials.

⚠ WARNING

When routing the sewer or macerator hose, do not place on or near the Oasis, generator or engine exhaust pipes. Otherwise, damage may occur.

How To Drain The Waste Water Holding Tanks

The holding tanks should only be drained when they are at least three-fourths full, to provide sufficient water to allow the complete flushing of waste materials in the drain lines and hose. If the tanks are not three-fourths full, add enough water to allow for sufficient flushing. Whenever possible, drain the holding tanks prior to traveling. The carrying capacity of your unit will be reduced if water is left in the black or gray tanks.

To empty the waste water tanks, follow the procedure below, depending on the type of waste system your coach uses. It is recommended to drain the black water tank before the gray water tank. The holding tank valves may be operated via a tank gate valve (t-handle) or an electric dump valve switch (when equipped).

DRAINING THE WASTE WATER TANKS ON A COACH WITH A STANDARD GRAVITY DRAIN AND DUMP SYSTEM

1. Connect the adapter to the drain hose.
2. Unscrew the drain cap, and connect the hose with the adapter to the drain fitting. Support the hose as needed for optimal flow.
3. Open the gate valve all the way by pulling on the T-handle. The tank will start to drain as soon as the T-handle is pulled.
4. After you have drained the black water tank, immediately drain the gray water tank, allowing the water from the gray tank to wash the black water residue from the drain lines and hose.
5. When both of the tanks are empty, flush them with fresh water before you close the valves. Flush the gray tanks by pouring a couple of gallons of water into a sink drain. The drain outlet is engineered for quick release of the drain hose adapter.
6. Always close the gate valves and secure the end cap to prevent leakage while in transit.
7. Add a holding tank deodorant to help control the odor and break down the solid waste.

DRAINING THE WASTE WATER TANKS ON A COACH WITH A MACERATOR WASTE SYSTEM (SANI-CON)

The Sani-Con macerating waste system provides the following convenient features:

- Provides a sanitary method for discharging liquid waste from the RV by easily and quickly emptying waste-water from the RV's holding tanks, without relying on gravity.
- The macerating system pumps liquid waste from holding tanks and does not rely on gravity.
- The macerator is designed to process human waste and toilet tissue, making the Sani-Con ideal for black water, as well as gray water, discharges.

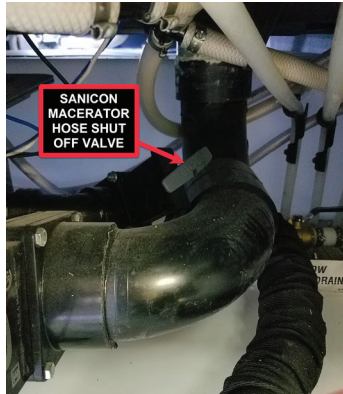

1. Make sure the black and gray water dump valves are closed.
2. Point the hose nozzle upward, and remove the nozzle cap.

IMPORTANT

Select coaches equipped with a Sanicon macerator may have a valve to shut off the waste flow to the macerator drain hose. This valve can be shut off when using the larger gravity drain to prevent pressure and waste in the small hose when not in use or in the event that the small hose develops a leak. However, this valve must be open if you plan to use the macerator drain hose. You must open the valve prior to turning on the macerator.

3. Insert the nozzle into the sewer connection.
4. Open the gray water dump valve, and run the macerator pump for a few seconds to confirm that the system is operating correctly.

IMPORTANT

If there is a problem with the connection, or if the system is not functioning correctly, the macerator may need to be cleaned or serviced.

5. Shut the gray water dump valve, and turn off the pump switch once you have determined that there are no problems.
6. Open the black water dump valve, and turn on the macerator pump switch.
7. Monitor the tank as it empties. The pump will run louder when the tank is empty.
8. Turn off the pump switch once the tank is empty.
9. Flush the black tank, and operate the macerator while it is flushing.

10. Turn off the flush system, then turn off the macerator.
11. Close the black water dump valve.

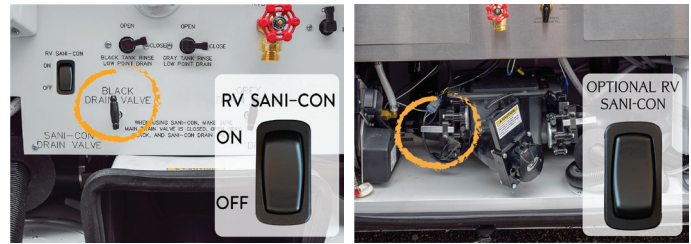

12. Add tank chemicals and the amount of water recommended by the chemical manufacturer. If the coach is equipped with two black tanks, add tank chemicals to both via the toilets.
13. Drain the gray tank next to help flush out the macerator and sewer hose.
14. Open the gray water dump valve.
15. Turn on the pump switch.
16. Monitor the tank as it empties. The pump will run louder when the tank is empty.
17. Turn off the pump switch once the tank is empty.
18. Flush the gray tank, and operate the macerator while it is flushing (if equipped).
19. Turn off the flush system, then turn off the macerator.
20. Close the gray water dump valve.



21. Place the cap on the hose and store it.
22. Add tank chemicals and the amount of water recommended by the chemical manufacturer.

Camping with Sewer Hook-Up

When camping at parks with sewer hook-up, it is important to keep the black water holding tank gate valve closed at all times, except when dumping. The gray tank can be kept open while hooked to a sewer connection, but the black water tank must be kept closed. This is done so that an ample supply of liquid remains in the tank to provide a smooth flow through the gate and drain valve when dumping.

Sufficient liquid in the tank causes a swirling action that should take any accumulated solid wastes with it. Accumulation of solid wastes in the black water tank can be avoided by keeping the gate valve closed when connected to the sewer hook-up. If the valve is left open, solid wastes may accumulate in the tank. This may eventually result in costly repairs.

Thetford SaniCon Waste Disposal System Operation (Model: Turbo 700)

This article provides basic operation instructions for a Thetford SaniCon Waste Disposal System (Model: Turbo 700).

⚠ CAUTION

Flush only organic human waste and toilet issue. Do not flush non-dissolving articles such as feminine hygiene products, paper towels, or moist towelettes, as this will damage the macerator and will void your warranty.

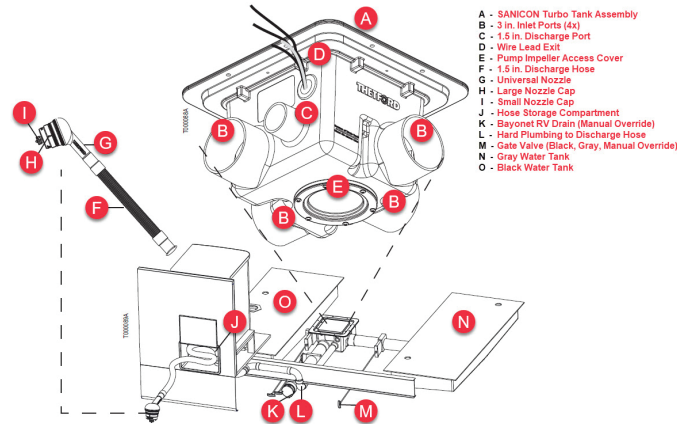

Operation

THERMAL CUT-OFF SWITCH

Because SANICON Turbo pumps are designed for intermittent duty, the pump contains a thermal cut-off switch for your safety. Typical run time is 15-20 minutes of operation before the thermal shut-off switch turns the pump off. After 20 minutes, the thermal cut-off switch will reset and allow the pump to run again.

- If the pump is run immediately after a thermal reset, it will run for approximately five to eight minutes.
- If allowed to cool for several hours, it will run the full 20 minutes.

ATTACH TO PUMP STATION

1. Open hose storage compartment (J); pull out hose (F) and nozzle (G) with caps; do not disconnect from coach.
 - Notice: Remove cap (H) for full hose extension.
2. Unscrew large nozzle cap (H).
3. Attach universal nozzle (G) to dump station.

EMPTY BLACK WATER TANK

1. Ensure universal nozzle (G) is securely attached to dump station!
 - Tip for Cleaner Storage: Emptying the black water tank first, allows gray water to cleanse the system.

2. Open black water tank gate valve (M).
3. Turn pump on.
4. Do not leave unit unattended.
 - Tip: The hose expands as fluid moves to dump station and contracts when tank is empty.
5. Turn pump off.
6. Close black water tank gate valve (M).

EMPTY GRAY WATER TANK(S)

1. Ensure universal nozzle (G) is securely attached to dump station!
 - Tip for Cleaner Storage: Emptying the black water tank first, allows gray water to cleanse the system.
2. Open gray water tank gate valve (M).
3. Turn pump on.
4. Do not leave unit unattended.
 - Tip: The hose expands as fluid moves to dump station and contracts when tank is empty.
5. Turn pump off.
6. Close gray water tank gate valve (M).
7. Repeat steps 2-6 for secondary gray tanks.
 - Notice: Gray water bypass is possible if the discharge plumbing does not flow upward.

PREPARE HOSE FOR STORAGE

1. Ensure pump is off.
2. Empty hose (F) by holding at a sloped angle to direct excess water into the dump station.
 - Tip for faster draining: Leave gray gate valve (M) open allowing hose to vent and expediting the process.
3. Disconnect nozzle (G) from dump station.
4. Install cap(s) (H, I).
5. Return hose to coach hose compartment (J); leave hose connected to coach.

HELPFUL HINTS

- Empty the black water first. Use gray water to rinse the hose after emptying the black water.
- Make sure the discharge hose is completely empty before storing.

Source(s): Thetford Sanicon Turbo 700 Owner's Manual (97515 Rev. F - 07/03/2019)

Product(s): Thetford Sani-Con Turbo 700 Disposal System (Model: Turbo 700, Newmar Part Number: 133468)

Holding Tank Rinse - No Fuss Flush

This article provides an overview of the holding tank rinse (no fuss flush) system. The coach may be equipped with a flushing system for the holding tank(s).

Tank Rinse Overview

The basic tank rinse system consists of:

- a water inlet,
- a vacuum breaker to prevent water from siphoning back out of the tank and into the hose (normally located in a lavatory cabinet to provide placement above the height of the tank),
- a fixed sprayer in the tank,
- and connecting water lines.

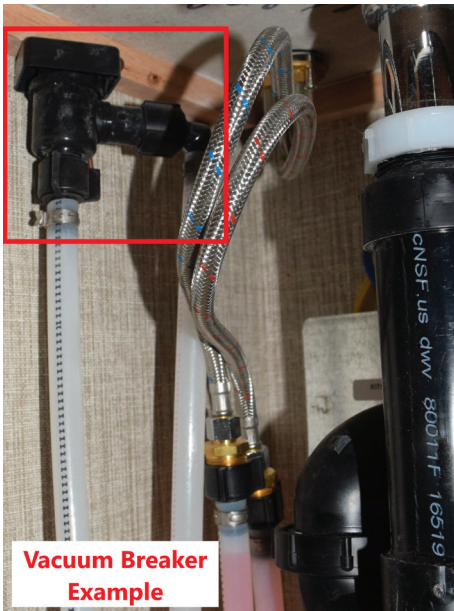

Black Tank Rinse

When draining your sewer tank, attach a water hose to the sewer spray hookup. After the tank is drained, leave the gate valve open, and open the water valve to allow water to spray inside the sewage tank.

Allow the water to rinse the tank for a minimum of three to five minutes to ensure it is clean. This should flush the inside of the tank of any debris that may be left inside.

⚠ CAUTION

Do not use the tank flush valve unless the fullway termination valve is in the open position. Can result in an unsanitary condition leading to illness or personal injury. AD-125

⚠ CAUTION

SEWAGE TANK RINSE
Open gate valve when in use. NI-23

Next, disconnect the freshwater hose and close the gate valve. If there are any solids still left inside the tank, fill the sewage tank with approximately ten gallons of water and holding tank chemical through the stool. As you travel, the agitation of the water should help liquefy any solids left in the tank. You can dump the sewage tank again at your next destination.

Grey Tank Rinse

Select coaches may also have a tank flush on the grey water tank. Follow the same flush procedure by leaving the grey tank gate valve open while flushing.



Tank Rinse Low Point Drain(s)

On coaches equipped with tank rinse low point drain(s), turning the tank rinse drain valve to the “open” position will remove pressure and drain the tank rinse line. When finished using the tank rinse, it is recommended to turn off the water supply to the tank rinse connection. Open the valve, and drain off the pressure in the line before disconnecting the water hose.

⚠ CAUTION

Do not use the same hose for the No Fuss Flush that is used for filling the fresh water tank. The gate valve to the sewage tank must be in the **OPEN** position while rinsing with the No Fuss Flush system.

⚠ IMPORTANT

Always drain the sewage tank prior to rinsing. Never rinse a sewage tank that is full. The sewage drain must be open while rinsing the sewage tank, and the drain hose must be positioned to drain into an approved sewage dump station. Failure to open the valve will cause the sewage tank to fill with water, and can cause damage to your plumbing and interior.

If you require additional instructions on gray/sewage tank valve operation, refer to the Waste Water Disposal article in Newgle.

This page is intentionally blank.



SLIDEOUTS

This chapter provides information about electric flat floor, bedroom, kitchen, wardrobe, and full wall slideouts, as well as hydraulic slideouts.

⚠ IMPORTANT

Before operating any slideout, read and follow the warning labels and operation instructions posted in your coach.

Leveling and Full Wall Slideout Sequence of Operation

This article provides step-by-step instructions for leveling the coach and operating the slideouts.

⚠ IMPORTANT

In the past, Newmar has recommended leveling the coach prior to deploying the slideouts. As of 2015, Newmar makes the following recommendation for the extension and retracting of slideouts.

Motorhomes, like all vehicles, flex in travel. Flexing may be different due to terrain and the coach's fulcrums (resting on tires or jacks). As the coach flexes, this movement is more noticeable in the outside reveal on a wider slideout.

Extending The Slideouts and Leveling The Coach

1. Park the coach on a reasonably level campsite.
2. Leave the coach at ride-height with air in the air bags (if equipped with air suspension) or on normal suspension (coaches without air suspension).
3. Plug the coach into shore power (if available) or start the generator to increase the voltage for better slideout operation.
4. Look at the "reveal" or "gap" of the two vertical wall trims around the slideouts to make sure there is plenty of clearance so the trim will not rub when extending the slideout. If the gap looks good, then the slideout can be operated.
 - **Note: Most often the gap will look best when sitting on the tires with the air suspension inflated (at ride-height), and not on the jacks.**



⚠ IMPORTANT

In the unlikely occasion that the slideout trim has inadequate clearances, try leveling or repositioning the coach and rechecking the clearances before extending the slideout.

5. Verify that the path of the slideout is unobstructed and free from any surrounding objects, both inside and outside of the coach.
6. Once the appropriate conditions are met, follow the operating instructions posted in your coach to extend the slideouts (image for example only).

7. Dump the air suspension (if equipped). This step is included in the auto-leveling process for most coaches.
8. Deploy the leveling jacks.

Retracting The Jacks and Slideouts

1. Retract the leveling jacks.
2. Start the coach.
3. Allow the coach air suspension to fill and return to ride height (units without air suspension will return to normal suspension).
4. Turn the engine off.
5. Verify that the path of the slideout is unobstructed and free from any surrounding objects, both inside and outside of the coach. This includes any water or debris that may have collected on the slideout roof or the topper awning.

⚠ IMPORTANT

Debris left on the roof or topper may prevent the slideout from sealing properly when retracted, as well as prevent the mechanical lock arms from closing properly when the slideout is extended.

6. For a full wall slideout, visually inspect the front vertical trim for adequate clearance prior to complete retraction (when the slideout trim spacing can be observed). The spacing should look even from top to bottom (see image for reference).

⚠ IMPORTANT

In the unlikely occasion that the slideout trim has inadequate clearances, try leveling, or if necessary, repositioning the coach, and rechecking the clearances before fully retracting the slideout.

7. Retract the slideouts. Inspect all slideouts for complete retraction.
8. If the coach is equipped with manual lock arms, make sure to lock them.
9. Unplug the coach from shore power when you are ready to depart.

Electric Slideouts

Electric Slideout Operation

This article provides basic operation instructions for an electric slideout.

Electric Slideout Switches



ELECTRIC BEDROOM SLIDEOUTS

The operating switch for the bedroom slideout is usually located on the bedroom wall. If there is a full wall slideout on the driver side of the coach, the switch may be located on the wall that separates the bedroom from the living room.

ELECTRIC FLAT FLOOR SLIDEOUTS

Newmar pushed the RV industry forward by introducing the first flat floor slideouts. We continue to lead today with our patented flat floor slideout designs. The same insight and experience that helped us improve slideout functionality has also helped us improve slideout quality.

The operating switch for the flat floor slideout is usually located in the overhead cabinet above the driver or passenger chair or the overhead cabinet above the entrance door.

ELECTRIC FULL WALL SLIDEOUTS

Most electric full wall slideouts extend from the living area to the master bathroom in a Newmar coach.

ELECTRIC KITCHEN SLIDEOUTS

The operating switch for the kitchen slideout is usually located in the overhead cabinet above the driver or passenger chair or the overhead cabinet above the entrance door.

ELECTRIC WARDROBE SLIDEOUTS

The operating switch for the wardrobe slideout is usually located in the bedroom, on the wall beside the corresponding slideout.

Electric Slideout Operation

In order to operate a slideout with the required voltage levels, batteries should be fully charged, the generator should be powered on, or the coach should be connected to shore power. This maintains the voltage levels required to operate the slideouts.

⚠ IMPORTANT

Read entire slideout room instructions posted in your coach before extending or retracting the slideout.

- On diesel coach slideouts: Park brake must be engaged before operation the slideout rooms. The slideout room will not operate when Park Brake is released.
- On gas coach slideouts: Ignition key must be turned off or in accessories position before operating the slideouts. The slideout rooms will not operate when the ignition key is in the ignition ON position.

EXTENDING THE SLIDEOUT ROOM

1. Slideout end windows must be shut before moving room.
2. Look for and remove any obstructions before moving room.
3. Caution on motorhomes: Move driver seat forward before moving room.
4. If rooms are equipped with Manual Lock-Arms, be sure to release arms before running room out.
5. Press and hold the appropriate slideout switch until the slideout is fully extended and stops moving.
6. Release the switch. Note: The slideout room movement can be stopped at any time by releasing the switch.

RETRACTING THE SLIDEOUT ROOM

1. Slideout end windows must be shut before moving room.
2. Look for and remove any obstructions before moving room.
3. Caution on motorhomes: Move driver seat forward before moving room.
4. Press and hold the appropriate slideout switch until the slideout room is fully retracted and stops moving.
5. Release the switch. Note: The slideout room movement can be stopped at any time by releasing the switch.
6. If rooms are equipped with Manual Lock Arms, be sure to engage lock arm when rooms are in and before moving coach.

Manual Operation of Room

Refer to the Manual Operation Instructions located on the kitchen overhead cabinet.

INSTRUCTIONS

READ ENTIRE SLIDE-OUT ROOM INSTRUCTIONS BEFORE MOVING SLIDE-OUT ROOM

GENERAL INSTRUCTIONS:

- 1) On Diesel coach slide-out: Park Brake must be engaged before operating the slide-out rooms. The slide-out rooms will not operate when the Park Brake is released.
- 2) On Gas coach slide-outs: Ignition key must be turned off or in accessories position before operating the slide-outs. The slide-out rooms will not operate when the Ignition key is in the Ignition ON position.

Extending Slide out Room:

- 1) Slide-out end windows must be shut before moving room.
- 2) Lock for and remove any obstructions before moving room.
- 3) **CAUTION ON MOTORHOMES:** Move driver seat forward before moving room.
- 4) If rooms are equipped with Manual Lock-Arms, be sure to release arms before running room out.
- 5) Press and hold the appropriate slide-out switch until the slide-out is fully extended and stops moving.
- 6) Release the switch. Note: The slide-out room movement can be stopped at any time by releasing the switch.

Retracting Slide out Room:

- 1) Slide-out end windows must be shut before moving room.
- 2) Lock for and remove any obstructions before moving room.
- 3) **CAUTION ON MOTORHOMES:** Move driver seat forward before moving room.
- 4) Press and hold the appropriate slide-out switch until the slide-out room is fully retracted and stops moving.
- 5) Release the switch. Note: The slide-out room movement can be stopped at any time by releasing the switch.
- 6) If rooms are equipped with Manual Lock-Arms, be sure to engage lock arm when rooms are in and before moving coach.

MANUAL OPERATION OF ROOM:
Refer to the MANUAL OPERATION INSTRUCTIONS located on the kitchen overhead cabinet.

Revision 01: 2018

INSTRUCTIONS

MANUAL SLIDE-OUT ROOM EXTENSION AND RETRACTING INSTRUCTIONS

READ ENTIRE SLIDE-OUT ROOM INSTRUCTIONS BEFORE MOVING SLIDE-OUT ROOM

MOTORS WITHOUT MANUAL DRIVE NUT:

- 1) Manual lock arms must be released from locked position prior to extending the room.
- 2) Access must be gained to the motor attachment bolts. Remove the bolts and slide the motor off the square part of the shaft.
- 3) Once the motor is off, the slide out can be pushed manually in or out.

MOTORS WITH MANUAL DRIVE NUT:
If the unit is equipped with the shaft through the gearbox motor which is mounted near the center of the slide-out room, use the following directions:

- 1) Manual lock arms and power locks must be released from locked position prior to extending the room.
- 2) Access must be gained to the slide out motor located in the center of the slide out room.
- 3) Releasing the motor's "Electro-Mechanical Brake": At the end of the motor remove the black plastic cover. Remove the tie-wrap and pull the cover off the motor. You must apply a 12 volt power source to release the brake. A source such as; a charged 9V battery will work. To apply the power source, separate the electrical connectors between the motor and brake and attach the connectors which lead to the brake to your power source. This will release the brake and allow manual cranking.
- 4) The manual extension or retraction requires only a 5/8" socket and ratchet wrench. By placing the socket on the 5/8" hex nut located on the gear box of the 900 motor, the slide-out can be moved in either direction by turning the hex nut.
- 5) If the slide-out does not move by using the hex nut, the room can be extended or retracted by using the procedure described for motors without the manual drive nut.

MANUAL OPERATION OF HWH ROOM:
Refer to the MANUAL OPERATION INSTRUCTIONS located in owners manual.

Revision 01: 2018

Slideout Safety

⚠ WARNING

Do not allow children to operate the slideout. Do not allow any person to place their arms, legs, body or head between any pinch point of the lock arms, slideout fascia, interior walls, exterior walls, objects, or floor as serious injury or death could result. Any adjustments, or repairs, must be made only by "Newmar" qualified personnel. Always check the interior and exterior of the coach for objects, or persons, that are in the path of the slideout when extending or retracting the room. Always check the room to be sure any objects, or debris, are removed before retracting the room. Operator must remain continually in control of the slideout room control switch while the room is moving in or out.

⚠ WARNING

Be sure that the driver's seat is in the forward position before activating the slideout room.

⚠ WARNING

Do not allow children to operate the slide-out. Do not allow any person to place their arms, legs, body or head between any pinch point of the lock arms, slide-out fascia, interior walls, exterior walls, objects, or floor as serious injury or death could result. Any adjustments, or repairs, must be made only by "NEWMAR" qualified personnel. Always check the interior and exterior of the coach for objects, or persons, that are in the path of the slide-out when extending or retracting the room. Always check the roof to be sure any objects, or debris, are removed before retracting the room. Operator must remain continually in control of the slide-out room control switch while the room is moving in or out.

NI-121

⚠ WARNING

Be sure that driver's seat is in the forward position before activating the slide out room.

NI-043

Electric Slideout Maintenance

This article provides care and maintenance information for the electric slideout. Electric slideout drive mechanisms do not require lubrication as part of the scheduled maintenance. Some noise is normal during extension and retraction from the various moving parts and seals.

Chains, Rollers, and Tubes

If a technician determines lubrication is needed on some component(s) such as chains, rollers, or tubes, Newmar recommends using a light coat of LPS 1 Greaseless Lubricant, which provides a dry, thin lubricating film that is resistant to dirt and dust buildup.

⚠ IMPORTANT

Newmar does not recommend the use of grease, silicone, or WD-40 on the slideout tubes or chains, as these products tend to collect dirt and dust.

Seals

If slideout seal lubrication is necessary, the slideout seal provider (Clean Seal) recommends using a silicone-based spray or water-based 303 protectant on the rubber slideout seals. They state this will not hurt the seal. They also stated that baby powder could be used but would need to be applied frequently, as it would wash away. The silicone base spray would last longer and would not need to be applied as often. Newmar recommends bi-annual treatment of slideout seals.

Motor Mounting Bolts

In addition, the torque on all electric slideout motor mounting bolts should be checked annually by an Authorized Newmar Service Center.

Cleaning The Slideout Rollers

This article provides information about when and how to clean the rollers on an electric slideout.

When To Clean The Rollers

⚠ IMPORTANT

It is important to clean the slideout rollers under the floor regularly. Dirt and other debris may adhere to the rubber coating on the rollers, which may lead to a dull finish, scratching, scoring, or further damage to the flooring. Such damage is NOT covered under warranty.

There is no set schedule for cleaning the slideout rollers. It will vary based on the cleanliness of the coach, and other factors such as dust, dirt, sand storms, as well as the type and condition of the roads traveled.

The following list provides examples of when the rollers should be cleaned:

- Liquid spills on the roller, floor, or under the slideout
- Fragments from broken glass, pottery, or other sharp objects on the roller, floor, or under the slideout
- Sand or other abrasive materials on the roller, floor, or under the slideout
- Hair wrapped around the roller or shaft
- The roller begins sliding on the floor instead of rolling smoothly

⚠ IMPORTANT

Slideout rollers may leave indentations in the flooring. This condition is normal and does NOT warrant flooring replacement.

How To Clean The Rollers

1. The slideout rollers can usually be accessed by extending the slideout half way.
2. Blow any remaining debris from under the slideout.
3. If possible, clean the ramps for the electric flat floor slideouts.
4. If more room is necessary to clean the ramp and rollers, push out on the top of the room and slide a wooden wedge between the floor and the bottom of the slideout in a few different places to create more clearance.
5. Clean the rollers one at a time with a soft cloth and a mild cleaner. A wet Swiffer cloth can also be used. Do not use harsh cleaners or solvents that may soften plastics.
6. Another alternative is to clean a portion of each of the rollers, then move the room slightly to clean the next portion. Repeat this process until all of the rollers have been cleaned all the way around.

Manually Retracting an R3 or O1 Series Electric Bedroom Slideout with a Square Shaft

This article provides instructions for manually retracting a bedroom slideout with a square shaft if it will not retract on its own.

⚠ IMPORTANT

If the slideout is stuck in the retracted position, take the coach to an authorized service center for diagnosis and repair. Do NOT attempt any of the following procedures.

⚠ IMPORTANT

Prior to proceeding with a manual retraction procedure, make sure the ignition key is in the off position and the park brake is set. Then, try retracting the slideout again, as some controllers require the ignition to be off, and others require the park brake to be set.

⚠ WARNING

The manual retraction procedures are for emergency use only. These procedures bypass all normal safety features. It is the responsibility of the person(s) performing the procedure to watch for moving parts and pinch points in order to avoid injury.

Option 1

This option requires the motor and gear box to be operational. This procedure bypasses the slide controller, switch, and the wiring. If battery power is unavailable, or if the motor/gear box is inoperable, move to a different option.

⚠ IMPORTANT

This procedure can be performed on any single motor electric slideout.

1. Disconnect the red and black wires connected to the motor.
2. Using the the wires attached to the motor, connect to a 12 volt cordless battery to retract the slideout. If the wire polarity is reversed, the slideout will extend instead of retract.

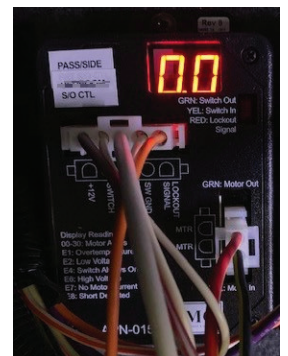

⚠ IMPORTANT

If the slideout motor has a brake installed, you must also hook one brake wire to the battery with the red slideout motor wire and one with the black slideout motor wire.

This can also be done at the slideout controller's wiring harness by removing the motor's red and black harness plug from controller and jumping a 12 VDC power source at the Molex plug.

3. Disconnect the wire(s) from the cordless battery pack.

Option 2

If the slideout is stuck in the extended position and option 1 is unavailable or fails:

COACHES WITH MANUAL LOCK ARMS

1. Remove the four mounting bolts, and move over the slideout motor until it disengages from the square shaft.
2. Manually push the room in or out.
3. Lock the room with manual lock arms (if equipped).
4. Take the coach to an authorized service center for diagnosis and repair.

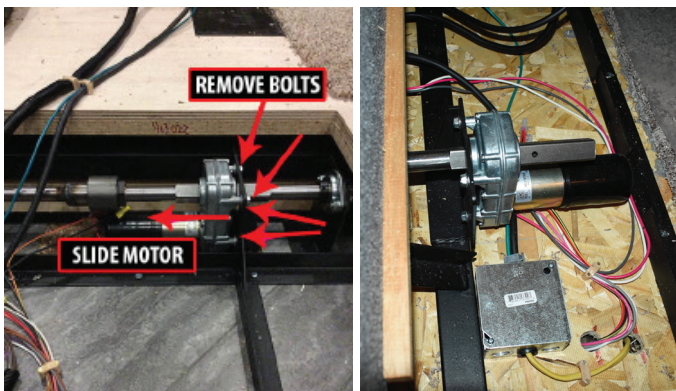
**COACHES WITH MECHANICAL LOCK ARMS**

1. Slide the motor back over onto the square shaft, and reinstall the four mounting bolts.
2. The motor and brake assembly must be installed (or another way devised) to hold the slideout in the retracted position prior to traveling.
3. Take the coach to an authorized service center for diagnosis and repair.

Manually Retracting a Single Motor Flat Floor or Wardrobe Slideout with a Square Shaft

This article provides instructions for manually retracting a single motor flat floor or wardrobe slideout with a square shaft if it will not retract on its own.

⚠ IMPORTANT

This procedure can be performed on coaches with a brake on the slideout motor.

Option 3

If the slideout is stuck in the extended position and option 1 and/or 2 is unavailable or fails, try the following steps to manually retract the slideout by removing the brake and turning the shaft. Only a few tools are necessary to complete this procedure; however, it requires the gear box to be operational.

⚠ IMPORTANT

Make sure you do not damage portions of the shaft that will slide through the motor, trantorque, bearing, and cog wheels.

1. First, locate the strap that secures the rubber boot on the outside of the motor.
2. Remove the strap, and pull off the rubber boot, removing it from the motor.
3. Remove the four screws from under the rubber boot on the brake.
4. Once the brake is removed, use a wrench to turn the shaft to retract the slideout.
5. After the slideout is fully retracted, reinstall the brake.



⚠ IMPORTANT

If the slideout is stuck in the retracted position, take the coach to an authorized service center for diagnosis and repair. Do NOT attempt any of the following procedures.

⚠ IMPORTANT

Prior to proceeding with a manual retraction procedure, make sure the ignition key is in the off position and the park brake is set. Then, try retracting the slideout again, as some controllers require the ignition to be off, and others require the park brake to be set.

⚠ WARNING

The manual retraction procedures are for emergency use only. These procedures bypass all normal safety features. It is the responsibility of the person(s) performing the procedure to watch for moving parts and pinch points in order to avoid injury.

Option 1

This option requires the motor and gear box to be operational. This procedure bypasses the slide controller, switch, and the wiring. If battery power is unavailable, or if the motor/gear box is inoperable, move to a different option.

⚠ IMPORTANT

This procedure can be performed on any single motor electric slideout.

1. Disconnect the red and black wires connected to the motor.
2. Using the the wires attached to the motor, connect to a 12 volt cordless battery to retract the slideout. If the wire polarity is reversed, the slideout will extend instead of retract.

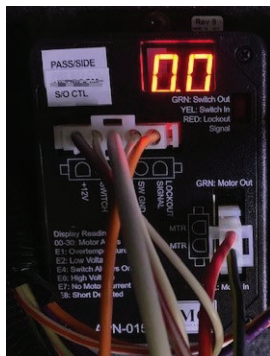

⚠ IMPORTANT

If the slideout motor has a brake installed, you must also hook one brake wire to the battery with the red slideout motor wire and one with the black slideout motor wire.

This can also be done at the slideout controller's wiring harness by removing the motor's red and black harness plug from controller and jumping a 12 VDC power source at the Molex plug.

3. Disconnect the wire(s) from the cordless battery pack.

Option 2

If the slideout is stuck in the extended position and option 1 is unavailable or fails, try the following steps to manually retract the slideout by removing the brake and turning the shaft. Only a few tools are necessary to complete this procedure; however, it requires the gear box to be operational.

1. First, locate the strap that secures the rubber boot on the outside of the motor.
2. Remove the strap, and pull off the rubber boot, removing it from the motor.
3. Remove the four screws from under the rubber boot on the brake.
4. Once the brake is removed, use a wrench to turn the shaft to retract the slideout.

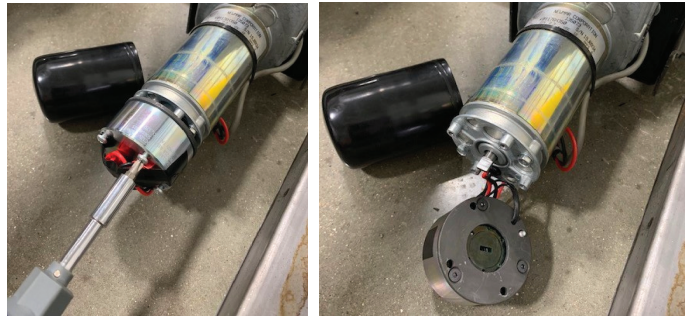

⚠ IMPORTANT

Make sure you do not damage portions of the shaft that will slide through the motor, trantorque, bearing, and cog wheels.

On slideout motors equipped with the 5/8" reduction gear nut, it can be turned to retract the slideout.

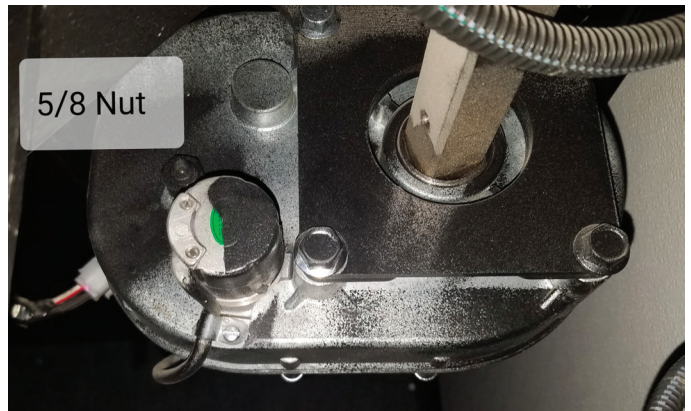

5. After the slideout is fully retracted, reinstall the brake.

Option 3 - Wardrobe Slideout Motor with Square Shaft

⚠ IMPORTANT

This procedure can be performed on coaches with a brake on the slideout motor.

IF THE SLIDEOUT IS STUCK IN THE EXTENDED POSITION

1. Remove the four mounting bolts, and move over the slideout motor until it disengages from the square shaft.
2. Manually push the room in or out, or use a wrench to rotate the shaft. Make sure you do not damage the shaft with the wrench.

WITH MANUAL LOCK ARMS

3. Lock the room with manual lock arms (if equipped).
4. Take the coach to an authorized service center for diagnosis and repair.

WITH MECHANICAL LOCK ARMS

3. Slide the motor back over onto the square shaft, and reinstall the four mounting bolts.
4. The motor and brake assembly must be installed (or another way devised) to hold the slideout in the retracted position prior to traveling.
5. Take the coach to an authorized service center for diagnosis and repair.

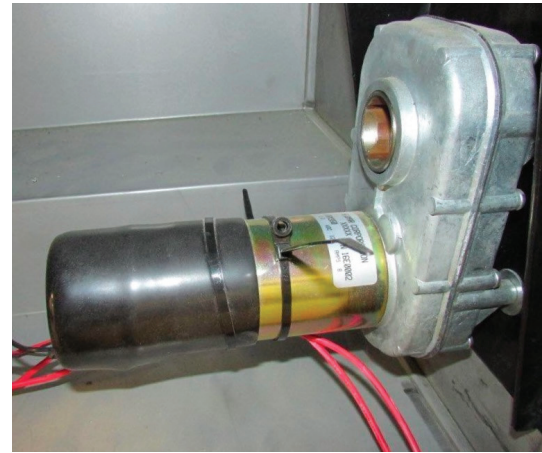

NOTICE

Depending on the year, model, and floorplan of the coach, the exact slideout motor(s) location may vary. Generally, they may be accessed from under the slideout in the compartment area. Some motors may also be located in the wheel well area under a cover.

Manually Retracting a Dual Motor Electric Full Wall or Kitchen Slideout with Square Shaft

This article provides manual retraction procedure options for a dual motor electric full wall or kitchen slideout with a square shaft.

Due to the dual motor setup, manual retraction using a separate battery or 12V source is not recommended since motors run at different speeds. This may increase the risk of binding the room and/or causing extensive damage to the drive assembly.

Option 1

IMPORTANT

This procedure can be performed on coaches with a brake on the slideout motor.

If the slideout is stuck in the extended position, try the following steps to manually retract the slideout by removing the brakes from each motor and turning the shaft. Only a few tools are necessary to complete this procedure; however, it requires the gear box to be operational and the person(s) retracting the room to keep the slideout from binding. This can be done by alternating moving each side in small increments or by turning each side simultaneously with a person at or near each motor or shaft assembly.

1. First, locate the strap that secures the rubber boot on the outside of the motors.
2. Remove the strap, and pull off the rubber boot, removing it from the motors.
3. Remove the four screws from under the rubber boot on the brake.
4. Once the brake is removed, use a wrench to turn the shaft to retract the slideout.



IMPORTANT

Make sure you do not damage portions of the shaft that will slide through the motor, trantorque, bearing, and cog wheels.

On slideout motors equipped with the 5/8" reduction gear nut, it can be turned to retract the slideout.

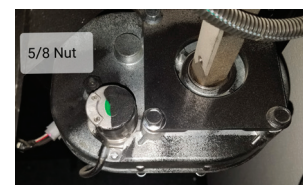

5. After the slideout is fully retracted, reinstall the brake.

Option 2

1. Remove the four mounting bolts, and move each slideout motor until it disengages from the square shaft.
2. Manually push the room in or out, or use a wrench to rotate the shafts. Make sure you do not damage the shafts with the wrench and keep the room in sync to prevent binding.

WITH MANUAL LOCK ARMS

3. Lock the room with manual lock arms (if equipped).
4. Take the coach to an authorized service center for diagnosis and repair.

WITH MECHANICAL LOCK ARMS

3. Slide the motor back over onto the square shaft, and reinstall the four mounting bolts.
4. The motor and brake assembly must be installed (or another way devised) to hold the slideout in the retracted position prior to traveling.
5. Take the coach to an authorized service center for diagnosis and repair.

⚠ NOTICE

Depending on the year, model, and floorplan of the coach, the exact slideout motor(s) location may vary. Generally, they may be accessed from under the slideout in the compartment area. Some motors may also be located in the wheel well area under a cover.

Hydraulic Slideouts

HWH Hydraulic Slideout Operation

This article provides basic operation instructions for a HWH hydraulic slideout.

⚠ WARNING

Read the HWH Operation manual for your slideout and follow all safety warnings and notices.

⚠ CAUTION

When operating the HWH Hydraulic Flat Floor Slideout, the coach must be plugged into shore power or operating on generator power with full voltage, or damage could occur to the coach.

The operating switch for the Hydraulic Flat Floor Slideout is usually located in the overhead control panel.



Due to the slideout safety feature commonly referred to as 'ignition lockout', the operation of your slideout will be prohibited under one or more of the following conditions:

- Total slideout operation is prohibited when the ignition switch is in either the accessory or run position.
- Total slideout operation is prohibited when the park brake is not set.

The disabling of the slideout is based on the individual slideout control module programming and the ignition switch circuit signal.

Once the appropriate safety feature conditions are met and the path of the slideout is unobstructed both inside and outside of the coach, follow the operating instructions posted in your coach.

⚠ IMPORTANT

Read entire slideout room instructions posted in your coach before extending or retracting the slideout.

⚠ NOTICE

During normal operation of the room, do not reverse direction of the room until the room is fully extended. If necessary, the direction of the room may be reversed, but watch for binding of the room. If the direction of the room has been reversed, do not re-extend the room until the room has been fully retracted, as the room may not drop to the level out position.

⚠ IMPORTANT

Do not hold the 'in' or 'out' switch for more than ten seconds after the room has stopped moving from the fully retracted or fully extended position. If at any time the slideout stops or is in a bind, release the slideout switch immediately. Do not force the room or reverse directions. Contact Newmar Customer Service for assistance.

- On diesel coach slideouts: Park brake must be engaged before operation the slideout rooms. The slideout room will not operate when Park Brake is released.
- On gas coach slideouts: Ignition key must be turned off or in accessories position before operating the slideouts. The slideout rooms will not operate when the ignition key is in the ignition ON position.

EXTENDING THE SLIDEOUT ROOM

1. Slideout end windows must be shut before moving room.
2. Look for and remove any obstructions before moving room.
3. Caution on motorhomes: Move driver seat forward before moving room.
4. If rooms are equipped with Manual Lock-Arms, be sure to release arms before running room out.
5. Press and hold the appropriate slideout switch until the slideout is fully extended and stops moving.
6. Release the switch. Note: The slideout room movement can be stopped at any time by releasing the switch.

RETRACTING THE SLIDEOUT ROOM

1. Slideout end windows must be shut before moving room.
2. Look for and remove any obstructions before moving room.
3. Caution on motorhomes: Move driver seat forward before moving room.
4. Press and hold the appropriate slideout switch until the slideout room is fully retracted and stops moving.
5. Release the switch. Note: The slideout room movement can be stopped at any time by releasing the switch.
6. If rooms are equipped with Manual Lock Arms, be sure to engage lock arm when rooms are in and before moving coach.

MANUAL OPERATION OF ROOM

Refer to the Manual Operation Instructions located on the kitchen overhead cabinet.

Slideout Safety

WARNING

Do not allow children to operate the slideout. Do not allow any person to place their arms, legs, body or head between any pinch point of the lock arms, slideout fascia, interior walls, exterior walls, objects, or floor as serious injury or death could result. Any adjustments, or repairs, must be made only by “Newmar” qualified personnel. Always check the interior and exterior of the coach for objects, or persons, that are in the path of the slideout when extending or retracting the room. Always check the room to be sure any objects, or debris, are removed before retracting the room. Operator must remain continually in control of the slideout room control switch while the room is moving in or out.

WARNING

Be sure that the driver’s seat is in the forward position before activating the slideout room.

WARNING

Do not allow children to operate the slide-out. Do not allow any person to place their arms, legs, body or head between any pinch point of the lock arms, slide-out fascia, interior walls, exterior walls, objects, or floor as serious injury or death could result.

Any adjustments, or repairs, must be made only by “NEWMAR” qualified personnel. Always check the interior and exterior of the coach for objects, or persons, that are in the path of the slide-out when extending or retracting the room.

Always check the roof to be sure any objects, or debris, are removed before retracting the room. Operator must remain continually in control of the slide-out room control switch while the room is moving in or out.

NI-121

WARNING

Be sure that driver's seat is in the forward position before activating the slide out room.

NI-043

How to Manually Lift a Hydraulic Flat Floor Slideout

This article provides instructions for manually lifting a hydraulic flat floor slideout.

⚠ CAUTION

Contact Newmar Customer Service (1-800-731-8300) prior to manually lifting or retracting your Hydraulic Flat Floor Slideout.

⚠ IMPORTANT

These brief operation instructions are for quick reference only and should not take the place of the complete manual(s) provided by this product's manufacturer. Refer to the corresponding links and files in Newgle for more details about your product.

⚠ NOTICE

Manual room lift procedures must be done before manual room retraction procedures.

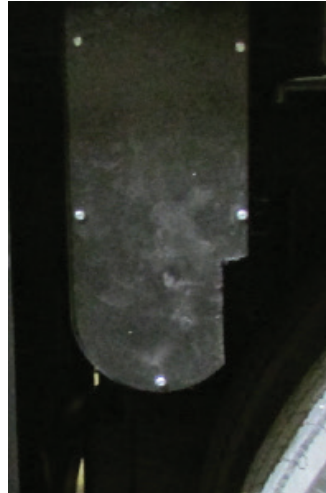

2. Locate the lift cylinder covers, like the examples shown. Some coaches may have an additional rubber cover installed over the ABS cover to protect the lift from the outside elements.

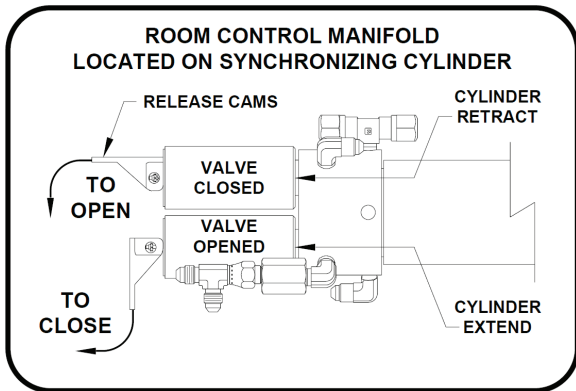

1. Determine which synchronizing cylinder controls the room. Manually open the valve release cams for the extend and retract solenoid valves by moving the cams to the "valve opened" position as shown.



3. Do not remove the screws on the flat side of the cover. Instead, remove the screws on the side of the cover, allowing the entire cover to be removed. Depending on the location, some covers may be sealed with foam or another sealant.

⚠ IMPORTANT

Release cam might be rotated to any direction on the valve. Make sure to move the release cams in the correct direction. Incorrect movement of the cams can damage the valves.

If the pump manifold is equipped with an auxiliary hand pump, you may be able to retract the room by opening only the room retract valve (as labeled by the wiring harness) and operating the hand pump, refer to the "Auxiliary Hand Pump Operation" page (in your HWH Operator's Manual) for instructions on the use of the hand pump and valves equipped with a release cam. If the room cannot be retracted with the hand pump, it will be necessary to use the lift bolts and room retract screws.

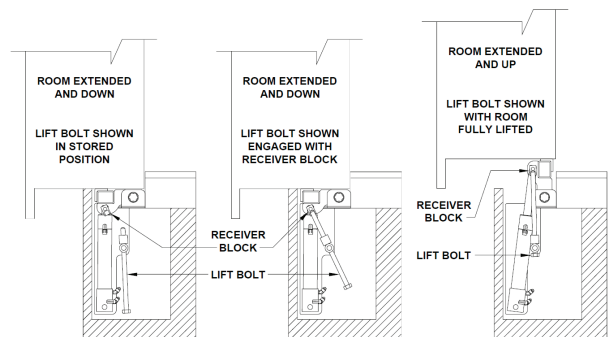

The lift bolt assembly may be mounted vertically or horizontally but will function the same way. Horizontally-mounted lift bolts may not have a cover, depending on the location within the coach.

⚠ NOTICE

There may be more than one platform lift cylinder assembly. There is a manual lift bolt for each assembly. All lift bolts must be used to lift the room.

4. Use a 13/16 wrench or socket to rotate the lift bolt(s) clockwise until they are seated in the receiver block. Continue to turn the bolt(s) until the room is completely lifted. When there are multiple lift bolts, alternate evenly between all lift bolts, turning each bolt two or three complete turns each time. Turning one lift bolt without alternating may cause the room to bind.

⚠ IMPORTANT

Do not use an impact wrench to turn lift bolts.

5. Leave the valves opened and refer to the “Manual Retract” article for room retract procedures.

⚠ IMPORTANT

If at any stage something is not understood, or if the room begins to bind, do not force the room. Contact Newmar Customer Support for assistance.

⚠ IMPORTANT

Do not retract lift bolt until you read the ‘Extending Room After Service’ section of the ‘Manual Retract’ article.

Source(s): HWH Computer-Controlled 725 Series Leveling System Operator’s Manual

Product(s): This source is associated with more than one product. Refer to Newgle for more information about the product(s) offered for your coach’s model year.

How to Manually Retract a Hydraulic Slideout

This article provides instructions for manually retracting an HWH hydraulic slideout.

⚠ CAUTION

Contact Newmar Customer Service (1-800-731-8300) prior to manually lifting or retracting your Hydraulic Flat Floor Slideout.

⚠ IMPORTANT

These brief operation instructions are for quick reference only and should not take the place of the complete manual(s) provided by this product’s manufacturer. Refer to the corresponding links and files in Newgle for more details about your product.

⚠ NOTICE

To access the threaded plates, refer to the vehicle manufacturer’s instructions below.

⚠ NOTICE

Some Newmar coaches may require removal of the interior vertical fascia, but current coaches are built with removable magnetic pieces or a sliding insert for easy access to the hole and plates. Coaches with lower cabinets secured to the fascia may have a removable access plug. In some cases, this access point may not align with the HWH threaded plate. In these instances, removal of the lower cabinet may be necessary to gain access to the plate.

⚠ NOTICE

Manual room lift procedures must be done before manual room retraction procedures on a HWH Flat Floor/Level-Out Room Extension. Manual lift procedures are not necessary for other HWH slideouts that do not drop down when extended.

1. Start both threaded rods until resistance is met one for the front and one for the rear mechanism should be provided.



Dutch Star Access Point



Mountain Aire Access Point



King Aire Access Point

2. Using the wrench provided, a personal wrench, or a tire iron with a 1-1/8” opening, rotate either mechanism’s threaded rod clockwise six complete turns.

⚠ IMPORTANT

Do not use an impact wrench to turn lift bolts.

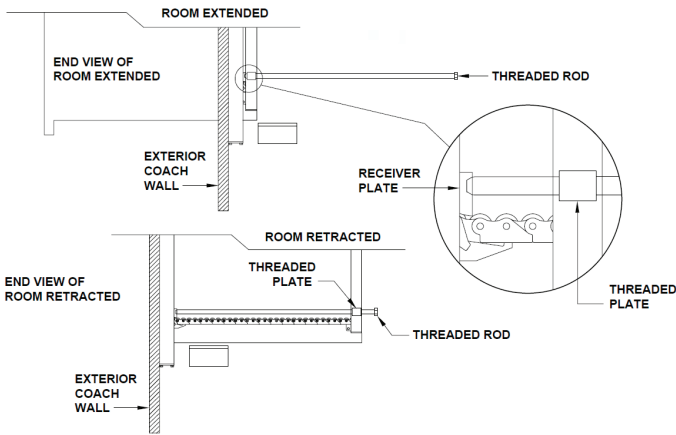

3. Move to the other room extension mechanism, and rotate the threaded rod clockwise 12 complete turns.
4. Return to the first room extension mechanism, and rotate the threaded rod clockwise 12 complete turns.
5. Repeat steps three and four, alternating from mechanism to mechanism, rotating each threaded rod 12 complete turns until room is sealed. Do not exceed 15 ft. lbs. Make sure the room does not bind.

⚠ IMPORTANT

If at any stage something is not understood, or if the room begins to bind, do not force the room. Contact Newmar Customer Support for assistance.

⚠ NOTICE

Leave the solenoid valves open, the lift bolts and threaded rods in place until the room has been serviced.

EXTENDING ROOM AFTER SERVICE

1. Room lift bolts should not be retracted yet. Push and hold the room switch to “retract” for five to ten seconds.

⚠ IMPORTANT

Do not extend the room until the room has been serviced. Any solenoid valves left open should be closed. The threaded rods should be completely removed before room is fully extended. If there is not enough room to remove both threaded rods completely, alternate backing the threaded rods out and slightly extending the room. Be careful to not extend the room so far that the threaded rods impact the coach wall or the mechanism.

2. Push the room switch to “extend” until the room is within one inch of being fully extended. Threaded rods should be completely removed at this time. Do not allow room to bind.
3. Retract all lift bolts completely. If room starts to drop, alternate between lift bolts evenly while turning lift bolts.
4. After lift bolts are retracted, push room switch to “extend” until room is fully extended and down. If room dropped while retracting lift bolts, push room switch to “extend” for five to ten seconds.
5. Retract room with room switch.

⚠ IMPORTANT

If at any stage something is not understood, or if the room begins to bind, do not force the room. Contact Newmar Customer Support for assistance.

Source(s): Universal Platform Level-Out Room Extension Mechanism Manual Room Lift Procedures and <http://www.hwh.com/ml55155.pdf> as adapted for Newmar Corporation v.09NOV15.

Product(s): This source is associated with more than one product. Refer to Newgle for more information about the product(s) offered for your coach’s model year.



CARE AND MAINTENANCE

This chapter includes information about required and recommended maintenance, inspection of components, as well as other maintenance items to help retain the coach's dependability, safety, visual appearance, and resale value.

⚠ IMPORTANT

Read and follow all maintenance schedules to meet warranty requirements. Preventive maintenance and scheduled maintenance items are not warrantable. Damage caused by improper or unapplied maintenance is not covered by your Newmar Limited Warranty.

How to Weigh a Coach

This article provides the Newmar-recommended procedure for weighing the coach. Below are some samples of the weight information labels that may appear in your coach.

MANUFACTURED BY / FABRIQUE PAR:		DATE:	
GVWR/PNBV	KG (LB)		
FRONT/AVANT	KG (LB)	TIRES/PNEU	RIMS/JANTE
INTERM/INTERM	KG (LB)		
REAR/ARRIERE	KG (LB)		
<small>THIS VEHICLE CONFORMS TO ALL APPLICABLE U.S. FEDERAL MOTOR VEHICLE SAFETY STANDARDS IN EFFECT ON THE DATE OF MANUFACTURE SHOWN ABOVE. THIS VEHICLE CONFORMS TO ALL APPLICABLE STANDARDS PRESCRIBED UNDER THE CANADIAN MOTOR VEHICLE SAFETY REGULATIONS IN EFFECT ON THE DATE OF MANUFACTURE. - CE VEICULE EST CONFORME A TOUTES LES NORMES QUI LUI SONT APPLICABLES EN VERTU DU REGLEMENT SUR LA SECURITE DES VEICULES AUTOMOBILES DU CANADA EN VIGUEUR A LA DATE DE SA FABRICATION. V.I.N./N.I.V.: _____ TYPE/TYPE: _____</small>			

Cargo Carrying Capacity (CCC): The weight equal to GVWR, minus each of the following: UVW, full fresh (potable) water weight (including water heater), full propane gas weight, and SCWR. (CCC = GVWR - UVW - Water Weight - Propane Weight - SCWR)

Gross Vehicle Weight (GVW): The weight of the unit with all items and supplies that are loaded into the unit at any point in time.

Sleeping Capacity Weight Rating (SCWR): The manufacturer's designated number of sleeping positions multiplied by 154 pounds (70 kilograms).

MOTOR HOME OCCUPANT AND CARGO CARRYING CAPACITY	
VIN: #####	
THE COMBINED WEIGHT OF OCCUPANTS AND CARGO SHOULD NEVER EXCEED:	
XXX kg or XXX lbs	
Safety belt equipped seating capacity: XXX	
CAUTION:	
A full load of water equals XXX kg or XXX lbs of cargo @ 1 kg/L (8.3 lb/gal) and the tongue weight of a towed trailer counts as cargo	

Figure 1 - Motor Home Occupant and Cargo Carrying Capacity Label

⚠ IMPORTANT

To assure the accuracy of your weights, make sure the unit is always level during weighing.

Weighing Your Coach

The unit has been built to comply with the component suppliers' recommended limits to provide you with a realistic CCC. When loading the unit, distribute the items so that not all of the weight is added to one area of the unit.

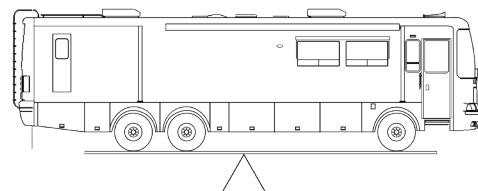

If you have questions as to what the weight of the unit is after it has been loaded, take the unit to a drive-on scale or use individual wheel scales, and verify that the weights are within the limits of those specified for the unit. When weighing the unit, follow these instructions. Failure to follow these instructions may give an erroneous weight reading.

To find the total weight of the unit, pull the unit onto the scales so that all of the wheels are on the scale as shown. Record the weight. This is the GVW and should not exceed the GVWR supplied by Newmar for the unit.

⚠ IMPORTANT

The sales literature may give approximates or standards. Each individual unit may weigh differently based on the factory and/or dealer options added.

Weight Descriptions

The following definitions are provided to help with communication issues with weight and your coach.

Gross Axle Weight Rating (GAWR): The maximum permissible weight for an axle.

Gross Combination Weight Rating (GCWR): The value specified by the manufacturer of the vehicle as the maximum allowable loaded weight of the motorhome and any towed trailer or towed vehicle.

Gross Vehicle Weight Rating (GVWR): The maximum permissible weight of the fully-loaded motorhome. The GVWR is equal to or greater than the sum of the UVW plus the CCC. (GVWR ≥ UVW + CCC)

Unloaded Vehicle Weight (UVW): The weight of this motorhome as built at the factory with full fuel, engine oil, and coolants. The UVW does not include cargo, fresh water, propane gas, or dealer-installed accessories.

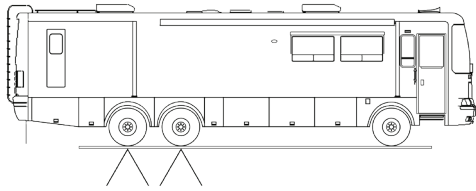

To find the total weight of the coach, except for the front axle, move the unit so that the front wheels are off the scales as shown. Record the weight. This weight should not exceed the total rating of the axles remaining on the scales. The front axle weight is determined by subtracting this weight from the GVW that was obtained in step one. This amount should not exceed the listed front axle weight rating.

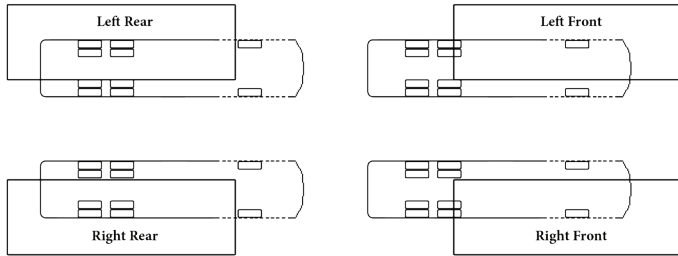

ALTERNATE WEIGHING PROCEDURE

The recommended procedure to accurately weigh a motorhome is on individual corner scales. Since these are not always available, this diagram shows how to weigh a motorhome on a typical truck scale.

Since only one corner can be weighed at a time, the remaining three corners need to be as close to the scale as possible without being on the scale, and the unit needs to be as level as possible. Remember, wind and rain can cause inaccuracies of weights.

⚠ IMPORTANT

Your coach has been aligned at the factory as part of the production process. To provide optimum tire longevity and offer the best handling characteristics, Newmar recommends you have your unit re-aligned after loading your belongings. Though highly recommended, this alignment is not mandatory, and as such, is not warrantable by Newmar or the chassis manufacturer.

How To Wash and Dry A Coach

This article provides the Newmar-recommended procedure for washing and drying the coach.

Washing The RV

The clear coat used on all painted portions of the exterior is a similar to the technology that used by car manufacturers. The same care needs to be performed and maintained on your coach exterior surface as on your automobile. Following these procedures can provide a long-lasting, high-gloss finish on your coach.

1. Make sure the coach's surface temperature is under 90° F. Never wash the vehicle in direct sunlight, while the vehicle is hot, or with hot water.
2. Rinse the entire coach to remove all loose dirt and grime. Never hold a pressure washer close to the surface. Use a fan-type spray nozzle, making sure that the water is not a single straight stream. Keep the stream at least 18 inches from the edge of any decals, as high pressure water may cause the decals to loosen and peel.
3. Most car stores offer mild car wash shampoos that are safe for clear coat finishes. You may also use baby shampoo to prevent leaving a film on the coach. Adding ½ of a cup of food grade vinegar to three gallons of water will boost the cleaning ability and will also soften the water to help minimize water spots. Rinse thoroughly to prevent soap residue accumulation.

⚠ IMPORTANT

Do not use dish soap, detergents with degreasing agents, or industrial cleaners, as they can cause damage to the finish on your coach.

⚠ IMPORTANT

Do not use solvents such as acetone, MEK, toluene, etc. on the decals. Any solvent including alcohol may soften or smear colors. Do not use lacquer thinner or paint on decals. Do not overcoat the decals with clear paint. Do not allow gasoline or other fuels to drip or stay on the decals for any length of time. If this occurs, immediately flush the area with water.

4. Use 100% cotton or Lambswool pads or wash mitts for washing the painted surfaces of your coach. Use a different mitt for washing the wheels and undercarriage.

The following products may assist you when cleaning your coach, and may be purchased through the Newmar parts department:

- Lambswool Pad (Newmar part #018461)
 - Backer Pad (Newmar part #018461A)
 - Lambswool Mitt (Newmar part #018464)
 - Extension Pole (Newmar part #018463)
5. Change the water in your wash bucket often, or place a "dirt guard" in bottom of the bucket to keep the cleaning pad or wash mitt free of dirt and debris.

⚠ IMPORTANT

Damage caused by improper or unapplied maintenance is not covered by your Newmar Limited Warranty.

⚠ IMPORTANT

Absolutely no brushes should be used on the painted surface of your coach, as it will cause damage to the finish, just as it would an automobile finish. Newmar does not support the use of any style, type, or brush material, even though it may be marketed as 'RV Safe' or 'Approved.'

⚠ CAUTION

The use of any cleaning products outside of Newmar's recommendation is at the customer's discretion. However, Newmar and BASF take no responsibility for any scratches, swirls, or damage to the finish of the coach caused by the use of non-recommended products.

Drying The RV

Drying your RV is just as important as washing it. Tap water and well water contain many chemicals that could water stain your coach's finish. After washing, dry your coach with the EZE Squeegee (Newmar part #018462) or a clean 100% leather chamois.

⚠ IMPORTANT

You can also use fresh microfiber towels for drying. Please use caution, as these towels are made partially with polyester (plastic), which can break down over time from extended use and washing, eventually causing damage to the clear coat finish.

Waxing and Polishing a Coach

This article explains the benefits and recommendations for using waxes and polishes to maintain your coach's finish.

The coating on your coach is a state-of-the-art base coat and Urethane clear coat. The clear coating is designed to protect the colored base coat, so it needs to be maintained, especially in harsh environments. Clear coats will appear to fade or lose gloss as the surface becomes contaminated by the environment. A finish that is dull or low in gloss is a result of contamination. Occasional washing alone will not adequately remove some forms of contamination and will require polishing of the finish.

The exterior finish of your coach will require a routine waxing. When water will not bead and roll off a freshly washed vehicle, a new coat of wax is needed. Wax not only improves the appearance of the vehicle, but it also protects the finish against oxidation and corrosive materials. The recommended type of wax is one that is compatible with painted or gel-coated fiberglass finishes, and contains a UV (ultra-violet) inhibitor. Buffing with a polishing compound will improve a dull or discolored finish.

⚠ IMPORTANT

When using a polishing compound that does not contain a wax preservative, reapplying a coat of hard wax after polishing is recommended.

⚠ IMPORTANT

Do not use products that contain harsh abrasives such as rubbing compounds, as these products should only be used by an experienced technician with proper training and equipment.

⚠ IMPORTANT

Refrain from waxing or polishing for at least 90 days from the coach's date of manufacture.

Benefits of Waxing and Polishing

- Remove minor surface imperfections caused by water spots and acid rain
- Remove minor scratches by filling them and leveling the surface
- Seal the pores of the finish, creating an easier-to-clean surface
- Beautify the paint finish appearance with more depth and high gloss
- Protect the paint finish from the elements

Most polishes and waxes are designed to clean and polish in one application, whether by hand or machine. A machine-applied polish will last longer than one applied by hand, as the high RPMs of the buffing wheel create heat, resulting in a deeper film with higher gloss. However, a hand-applied polish or wax will offer outstanding performance and protect the coach's finish.

Due to the variations of polishes and waxes, incorporate the following:

- Apply polish or wax while the coach is parked in a shaded area so the coach's surface is at the specified temperature according to the polish manufacturer's recommendations.
- Condition the polishing pad by rubbing a slight amount of polish on it.
- Use only the amount of polish specified in the label directions.
- Work a small area at a time.
- Rinse off and remove dried polish from crevices, trim, and moldings.

How to Clean Exterior Chrome

This article provides the Newmar-recommended procedure for maintaining your exterior chrome accessories.

1. Wash chrome items with soap and water the same way you wash the exterior paint.
2. If the chrome still has some tarnish and water spots on it, clean with a soft cloth and vinegar. Add a little baking soda to the rag if you need a stronger cleaner.
3. To clean rust off of the chrome, use a piece of crinkled aluminum foil dipped in vinegar. Scrub it with light to medium pressure, while making sure the foil stays wet with vinegar. In instances of rust and/or corrosion, you may use a very fine steel wool, but should be a last effort. Test it in an inconspicuous area to ensure no damage is occurring while using the steel wool.
4. Rinse the area with clean water after using any cleaning products.
5. Once the chrome is nice, bright, and shiny, dry it completely with a soft cloth.
6. Apply a coat of wax and buff it. Apply a second coat of wax, and buff it again.

⚠ IMPORTANT

The more often the chrome is cleaned, the easier the cleaning process. Coaches exposed to salt spray from the road or ocean air should be cleaned and waxed more often to maintain the best appearance.

How to Winterize a Coach

This article provides the Newmar-recommended step-by-step instructions for winterizing a coach.

⚠ NOTICE

The following instructions are generic to Newmar coaches, and are NOT specific to your coach. They should only be used as a reference guide for this process. Appliances, drain locations, and plumbing components may vary by coach. The following images are for example purposes only. Your coach may or may not be equipped with the same components as shown.

Follow the winterizing instructions to reduce the risk of leaks caused by cracks from freezing pipes. Damage caused from the fresh water system freezing can be extensive and costly to repair. A new coach may be equipped with a similar label if the system has been winterized.

This fresh water system has been protected with non-toxic anti-freeze. Please flush and drain lines before using. AD-70

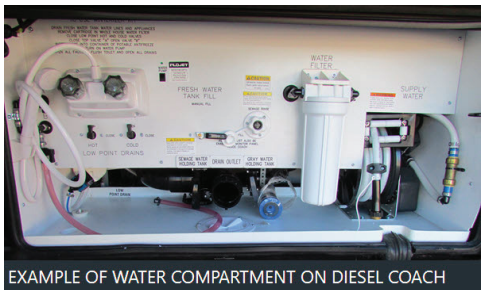

EXAMPLE OF WATER COMPARTMENT ON DIESEL COACH

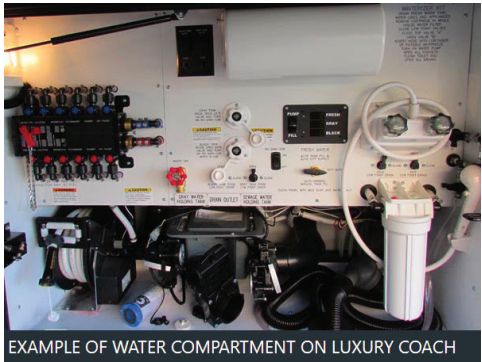

EXAMPLE OF WATER COMPARTMENT ON LUXURY COACH

⚠ IMPORTANT

Once water has been introduced into the system, it is no longer protected and must be winterized again any time the coach may be subjected to freezing temperatures.

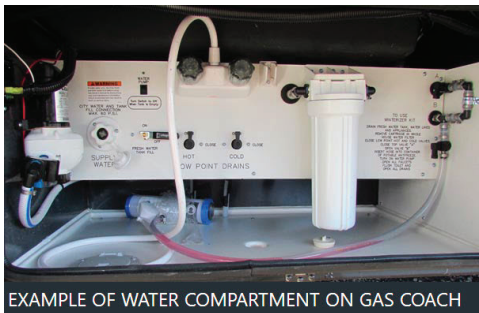

EXAMPLE OF WATER COMPARTMENT ON GAS COACH

When to Winterize a Coach

Although great care has been taken to build a well-insulated unit, recreational vehicles are not intended for extended use in sub-freezing weather without special precautions. When the outside temperature drops below freezing, the furnace must be turned on to keep the coach warm. Continued use in cold weather will require the coach to be winterized.

It is critical to winterize the plumbing in your coach when storing it in temperatures below freezing or using it in extremely cold conditions. If subjected to these conditions without being properly winterized, the heating system may be unable to keep the coach and its compartments above freezing temperatures.

⚠ WARNING

Winterizing is the responsibility of the consumer. Make sure you have protected the complete water system any time your coach is in freezing temperatures. Failure to complete the winterization process may result in extensive damage to the water system, appliances, and coach.

⚠ IMPORTANT

A regulated compressed air supply is needed to properly complete this procedure. The pressure should be regulated between 40 and 60 PSI (pounds per square inch). Higher pressures may cause damage.

How to Winterize a Coach

1. Drain the black and grey tanks. If equipped, also empty the macerator hose.
2. Drain the Fresh Water Tank. Open the tank drain valve located in the driver side water bay.
3. Turn off the switch(es) to the water heater or the hydronic heating system, including the burner and the 120 Volt element, depending on your coach's equipment.
4. Turn on the refrigerator.
5. While the tank is draining, remove all of the water filters. Install a bypass or the filter canister, including the whole house, refrigerator, and drink water filters (whether standard or UV), if your coach is equipped.



3 Bypass Valve System

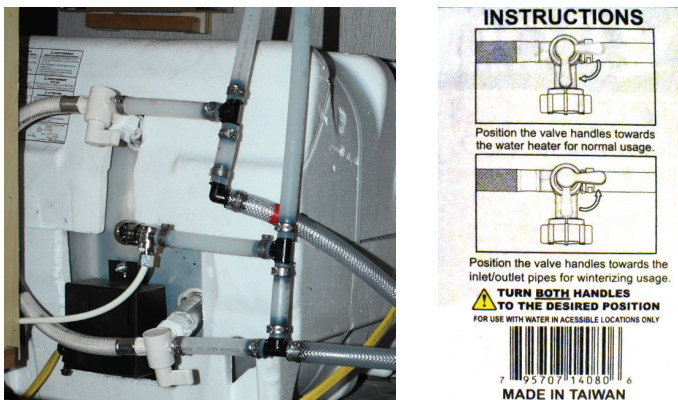

2 Bypass Valve System

6. For units with a tank-style water heater instead of a hydronic heater, close the valves to the water heater, and open the bypass valve, which is normally located at the back side of the water heater. Depending on your particular floor plan, access to the back of the water heater may be located in a cabinet, the closet, or in an exterior compartment.

⚠ NOTICE

For units with a tankless water heater, do NOT put the water heater in by-pass mode. Instead, blow it out, and install the antifreeze as directed for a hydronic heater.

7. Remove the drain plug at the bottom of the water heater tank on the exterior of the coach.

⚠ IMPORTANT

The 120 Volt water heater element must be turned off by flipping the switch near the water heater's drain plug.

⚠ IMPORTANT

On coaches equipped with a Truma AquaGo water heater mounted above the floor line of the coach, open the low point drain located in the hot water recirculation loop between the shower loop and the water heater. The exact location will vary, but the low point drain is typically located in the basement area at or near the lowest point in the loop and may be marked with a low point drain label.

8. Open the low point drains by turning the valve to the "open" position or by pulling up on the handle if the coach is equipped with T-Handle valves. There should be one drain for hot and one for cold, and they are normally located in the water compartment.
9. Connect the regulated air supply to the inlet of the hose from the hose reel (if equipped) or the city water fill inlet using a blowout plug. Air will flow out of the low point drains.
10. Cycle all faucets and the auto fill or tank fill valve (whichever the coach is equipped with) to all possible positions for a minimum of 10 seconds at each position. Do not forget the hot water spigot with low point drain next to the generator (if equipped).
11. Cycle the tank fill valve to all positions in order to purge water out of the lines and valve assembly.

⚠ IMPORTANT

On coaches equipped with Aqua View Showermi\$er Fresh Water Reclamation System, cycle the valve to the bypass position to purge the water out of the line back to the fresh water tank while pressurized air supply is connected. Then place the valve back to normal flow mode to the shower head, and then purge the shower. Do not leave the valve in bypass mode when running antifreeze in the line because it will allow antifreeze into the fresh tank.

12. After blowing the water out of the system with pressurized air, disconnect the hose, and pour approximately one cup of antifreeze into the hose. Hook the hose back up to the pressurized air, and blow the antifreeze through the hose and hose reel to protect it.
13. Close the low point drains. This must be done prior to pumping antifreeze through the lines, or the antifreeze will be pumped onto the ground.
14. Remove the whole house filter canister, and dump any remaining water, and reinstall.
15. Locate the winterizing valves marked “A” & “B” located in the water compartment.
16. Close valve “A” by rotating the valve clockwise. Open valve “B” by rotating the valve counter clockwise.
17. Remove the plug at the end of the clear winterizing hose.
18. Insert the hose into a jug or bucket of antifreeze.
19. Replace the empty jugs, or refill the bucket as needed to complete the entire process.
20. Turn on the water pump by activating water pump switch. Red antifreeze will start flowing through the clear hose into the water lines.
21. Run cold water from the kitchen faucet until the red potable antifreeze is detected. Run hot water from the kitchen faucet until the antifreeze is detected.

⚠ IMPORTANT

Make sure you run enough antifreeze through each faucet to fill each P-trap.

22. Proceed to the next faucet, and repeat process for each faucet, including the lavatory, shower sprayers, and outside shower faucet. If equipped, repeat the process for the instant hot water, drinking water dispensers, and hot water spigot with low point drain (next to the generator).
23. Flush each toilet until the red antifreeze is detected. If the toilet is equipped with a sprayer, activate and flush it until the antifreeze flows from the sprayer.

⚠ IMPORTANT

For coaches equipped with a sink or shower connected to a Saniflo Sanivite lift pump, the lift pump must be completely emptied, or enough RV antifreeze must be poured down the drains to allow the lift pump to cycle until the antifreeze concentration is sufficient for freeze protection. Pour at least one liter of antifreeze down the drain connected to the lift pump. Make sure the pump cycles at least once, then pour another liter down the drain. Wait for the lift pump to cycle again; then the remaining liquid in the lift pump should have an adequate antifreeze concentration at this point.

24. Run the dishwasher through a cycle to winterize the water inlet plumbing, as well as the pump and drain line.
25. If the coach is equipped, turn on the washing machine. Select a wash cycle setting that uses warm water to activate both the hot and cold inlet valves. Allow the washing machine to fill for approximately two minutes. Press the “cancel” and “drain” selection to begin draining the machine. This will winterize the pump and drain, as well as the washing machine’s P-trap.
26. Depress the refrigerator’s external water dispenser while holding a container to catch the fluid. Continue to let the fluid flow until the red antifreeze is detected.

⚠ NOTICE

The red antifreeze may not appear instantly, as most refrigerators have a reserve for cold water. However, if you did not remove the water filter in the refrigerator in Step 5, the fluid will run clear for a long time.

27. Make sure the ice maker is turned on. Once it reaches the proper temperature, it will attempt to make ice cubes, which will become pink in color. This may take several hours. Once they become pink, turn off the ice maker and the refrigerator. Empty the ice cube tray, and clean out the ice maker and freezer area.
28. Turn off the water pump. Close the winterizing valve “B”, and open valve “A”.
29. Insert the plug into the clear hose, and stow the winterizing hose.
30. If the coach is equipped, winterize the macerator by turning it on and emptying the black and gray holding tanks, allowing the macerator and macerator hose to fill with antifreeze. If there is no macerator in the coach, use the sewer hose to drain the black tank, followed by the gray tank.

How to De-Winterize a Coach

This article provides the Newmar-recommended step-by-step instructions for de-winterizing a coach.

1. Connect your water hose to a fresh potable water supply.
2. Set the auto fill or tank fill valve for city water supply.
3. Run water through each faucet, toilet, and shower on both hot and cold settings.
4. Run the dishwasher and the washing machine through a complete cycle before using.
5. Depress the refrigerator water dispenser while holding a container to catch the fluid being dispensed. Continue until clear water is dispensed.
6. Install the refrigerator filter (if equipped).
7. Turn off the water supply drain pressure from the system using low point drains. Install all filters in the system.
8. Close the low point drains.
9. Turn on the ice maker, allowing it to run through multiple cycles. Throw away any ice with antifreeze. Clean out the ice maker and the tray until clear ice is available.
10. If the coach is equipped with a water heater, install a drain plug. Open the water heater valves, and close the by-pass valve on the back side of the water heater.
11. Turn on the fresh potable water supply.
12. Open the hot water faucet until the water heater is filled and flows through the faucet without air.
13. Flip the water heater switch to the "ON" position. This is located near the drain plug (if equipped with a water heater).
14. Check the tank level, and dump if necessary.
15. The coach is now ready to use.

NOTICE

Newmar recommends installing clean filters unless the sanitization process will also be completed at this time.

How To Sanitize The Water System

This article provides the Newmar-recommended step-by-step instructions for sanitizing a complete water system.

NOTICE

The following instructions are generic to Newmar coaches, and are NOT specific to your coach. They should only be used as a reference guide for this process. Appliances, drain locations, and plumbing components may vary by coach.

Follow the sanitizing instructions to reduce the risk of fresh tank contamination. All of the water should be drained from the fresh water system when the coach is not in use for more than one week. Whenever possible, drain the fresh water tank before traveling or only carry what you will need to get to your destination. Water in the tank will reduce the carrying capacity of the coach.

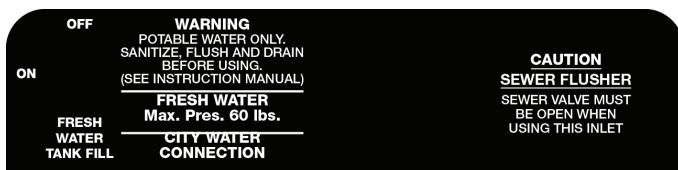

When To Sanitize The Water System

Newmar recommends sanitizing your water system under the following scenarios to discourage organic growth and contamination:

- Purchasing a new or used coach
- After your coach has been in storage for a lengthy amount of time
- At least once per year for proper maintenance
- If an unpleasant odor arises from your water

NOTICE

The Fresh Water System may need to be sanitized more often depending on the source of the water supplied to the coach.

How To Sanitize The System

1. Drain the fresh water tank by turning the tank drain valve to the open position.
2. Drain the water heater (if equipped) by removing the drain plug.

⚠ NOTICE

Do not attempt to drain the water heater when the water is hot or the system is pressurized, as scalding may occur.

While the tank is draining, remove all of the water filters, including the refrigerator and drinking water filters (standard or UV), if your coach is equipped, and install a bypass.

⚠ NOTICE

Not all filters have a 'bypass,' so it may be necessary to install the canister without the filter.

3. Remove the main (whole house) filter housing.
4. Remove the filter, and pour household bleach (1/4 cup per 15 gallons, as determined by your tank capacity) into the filter housing. For example: 1.75 cups of bleach for coaches equipped with a 105 gallon fresh water tank or 1.25 cups of bleach for coaches equipped with a 75 gallon fresh water tank. This will approximately be a 50 ppm (parts per million) bleach solution.

⚠ NOTICE

For any coaches not equipped with a whole house filter, skip these steps. Instead, use a funnel to pour bleach into the hose prior to hooking the coach up to a potable water supply.

5. Reinstall the housing and the water heater drain plug after it has drained completely.
6. Hook up the water hose from the hose reel (if equipped), or hook up a drinking water-safe portable hose to a potable water source.
7. Turn the valve to 'tank fill' or 'manual tank fill.'
8. Turn on the potable water source, and completely fill the water tank. (This will flush the bleach/water solution from the filter housing [Step 4] into the water tanks.)
9. Turn off the tank fill valve (on non-auto fill coaches).
10. Turn on the water pump.
11. Run water out of one faucet on both hot and cold settings until a strong bleach smell becomes evident.
12. Repeat this for all faucets, as well as the refrigerator, dishwasher, washing machine, toilets, low point drains, etc.

⚠ NOTICE

Top off the water tank so that the sides and top of the tank are sanitized as well.

13. Turn on the refrigerator and the ice maker. Depending on your refrigerator model, the ice maker may have a flip lever or an ON/OFF switch. Let the ice maker run until the bleach/water solution is detected. This may take a few cycles. One cycle consists of the ice maker filling the trays with water, freezing the water, and then dumping the ice into the ice bin. This cycling process will occur automatically if the refrigerator, the ice maker, and the water pump are all turned on.
14. Disconnect the water hose, and dump out some water.
15. Pour one ounce (1 oz.) of bleach into the water hose, and reconnect it to the potable water supply.
16. Turn on the water for a brief moment to flush the bleach through the water hose, allowing it to mix in the hose reel or the portable hose used for potable water.
17. Turn off the water supply, and disconnect the water hose.
18. Cap the end of the hose.
19. Let the bleach water sit in the system for a minimum of four hours. However, for best results, allow the solution to sit overnight or up to 12 hours.
20. Drain the fresh tank using the drain valve.
21. Fill the fresh tank with clean potable water.
22. Run water out of each faucet on both hot and cold settings until the bleach smell is no longer evident.

⚠ NOTICE

If the bleach smell is still noticeable, repeat steps 21-22 to flush the system again.

⚠ IMPORTANT

If algae or slime is detected in the fresh water system, it may be necessary to repeat the entire process until the system is flushed clean.

Once the system is flushed, Newmar recommends replacing the water filters. Do not re-use the contaminated filters, as this will greatly reduce the effectiveness of the sanitization process.

⚠ NOTICE

Sanitizing through the winterization process will not sanitize the fresh tank or all of the water lines.

Routine Maintenance Schedule (Diesel Coaches)

This article provides the Newmar-recommended routine maintenance schedule for diesel coaches.

⚠ IMPORTANT

All routine maintenance is the responsibility of the owner and is not covered by the Newmar Limited Warranty. Please note that damage caused by improper or unapplied maintenance is not covered by the Newmar Limited Warranty.

⚠ IMPORTANT

Cosmetic adjustments and alignments must be performed within the first three (3) months from date of original purchase for warranty consideration. Thereafter, these items are considered routine maintenance.

RV Service / Maintenance

Items supplied by other manufacturers may require specific individual maintenance not listed herein. Please refer to the manufacturers' suggested maintenance guidelines in the Owner's Information Packet.

Description	Weekly	Monthly	Quarterly	Bi-Annually	Annually	Other
Test smoke alarm, carbon monoxide detector, and propane gas detector.	X					
Check battery water level (liquid lead acid batteries only).		X				
Clean range hood exhaust fan filter and blades.			X			
Check LP gas lines for leaks with soap solution or leak detector.			X			
Check coach charging system and inspect battery connections/fluid levels			X			
Inspect and clean slideout rollers on each slideout.			X			
Inspect the exterior rubber slideout seals, and apply a UV inhibitor, such as 303 Protectant.				X		
Have the propane system inspected by a qualified technician.				X		
Check operation of windows, latches, and hinges.				X		
Check and replace water filters.				X		
Clean the roof ducted air conditioner filter(s).				X		
Service each roof air conditioner per manufacturer requirements.				X		
Clean and inspect all door and window seals, and reseal where necessary.				X		
Inspect and reseal around the tub and shower area where necessary.				X		
Lubricate the exterior door hinges and latches with a graphite (silicone) lubricant.				X		
Check, clean, and tighten battery cables, and inspect batteries for proper fluid level.				X		
Inspect roof seams and joints (should be performed by an Authorized Newmar Service Center. If resealing is necessary, it is the owner's responsibility and is not covered by the Newmar Limited Warranty).				X		
Check all gas appliances for proper operation.				X		
Check BIRD/BIM bi-direction charging system.				X		
Check exterior lights, including tow plug					X	
Perform generator oil, fuel, and air filter change					X	
Lubricate the moveable parts on the entrance step.					X	
Inspect the slideouts for proper seals. If realignment is necessary, please contact an Authorized Newmar Service Center.					X	
Sanitize the fresh water system.					X	
Wax and buff all gel-coat surfaces on the vehicle.					X	
Check mounting bolts on all electric slideout motors for proper torque. This should be performed by an Authorized Newmar Service Center. If any bolt is under-torqued, remove the bolt, and add blue LOCTITE® thread sealant to the bolt threads. Reinstall and torque all 5/16" bolts to 19 ft. lbs. and all 3/8" bolts to 33 ft. lbs.					X	
Refrigerator (House-type) - Annual maintenance (includes water and air filter)					X	
Refrigerator (Absorption-type) - Supplier required maintenance (clean burner, cooling unit's flue and spiral baffle, roof cap screen or upper side vent. Check control board sequence for correct functionality).					X	
Service forced air furnace					X	
Service LP water heater burner, flush tank, and check anode rod					X	
Water pressure / leak test / flush system / sanitize all tanks					X	

Description	Weekly	Monthly	Quarterly	Bi-Annually	Annually	Other
Service jacks / leveling system					X	
Service AquaHot/Oasis Furnace/Water Heater (Every THREE years)						X

Chassis Service / Maintenance

IMPORTANT

Always follow the chassis maintenance guidelines found in the chassis manufacturer owner’s manual.

Description	3 Months / 7,500 Miles	12 Months / Varying Miles	24 Months / 24,000 Miles	36 Months / Varying Miles	48 Months / Varying Miles
Torque suspension	X				
Check engine support fasteners	X				
Check wheel bearing lube level - steer and tag axles	X				
Check drive axle fluid level and breather	X				
Lube drive shaft	X				
Inspect belts, hoses, clamps, and air restriction gauge	X	X	X	X	X
Lubricate mechanical fan system	X	X	X	X	X
Weigh coach and adjust ride height	X	X	X	X	X
Check tire pressure	X	X	X	X	
Rotate the tires as recommended by the tire manufacturer.	X	X	X	X	
Replace air cleaner		X		X	
Inspect radiator and CAC for debris and damage		X	X	X	X
Check alternator, chassis batteries, and starter		X	X	X	X
Inspect belts and belt tensioners		X	X	X	X
Lube throttle pedal and brake pedal pivot points and slide		X	X	X	X
Change engine oil and filter		X	X	X	X
Replace fuel filter and fuel/water separator		X	X	X	X
Inspect wheel seals and axle breather		X	X	X	X
Change lube oil in oil filled hubs (steer and tag axles)		X	X	X	X
Change lube oil in drive axle and clean magnetic plug		X	X	X	X
Change power steering / hydraulic reservoir fluid and filters		X	X	X	X
Change lube oil in fan gear box and lube joints		X	X	X	X
Service air dryer			X		X
Replace coolant filter and check coolant level		X	X		X
Lube chassis, check fluid levels, and drain air tanks		X	X	X	X
Inspect brake linings, hoses, valves, slack adjusters, etc.		X	X	X	X
Inspect fuel tank mounting and fuel lines		X	X	X	X
Inspect suspension and height control valves		X	X	X	X
Inspect exhaust system		X	X	X	X
Replace coolant and coolant filter					X
Inspect crankcase breather		X	X	X	X
Replace transmission fluid and filters (Transynd)		X			X
Replace transmission fluid and filters (Dextron)		X	X	X	X

Fuel, Oil, and MPG Record

Use this chart to keep track of all odometer mileage, fuel, oil, and average MPG for the coach. For additional pages, refer to Newgle.

Date	Odometer Milage	Fuel (Gallons)	Oil (Quarts)	Average MPG	Cost

Date	Odometer Milage	Fuel (Gallons)	Oil (Quarts)	Average MPG	Cost



**WHEN YOU KNOW
THE DIFFERENCE.**

Newmar Corporation | 355 N Delaware St | PO Box 30
Nappanee, IN 46550-0030 | 574-773-7791 | Fax 574-773-2895
NewmarCorp.com