

2016 MA DP TILE

PLEASE ACKNOWLEDGE AND DATE THE FOLLOWING ORDER/PRINT FOR APPROVAL TO BUILD, AND FAX TO NEWMAR (AT 574-773-2895) AS SOON AS POSSIBLE

DATE: _____
SIGN: _____

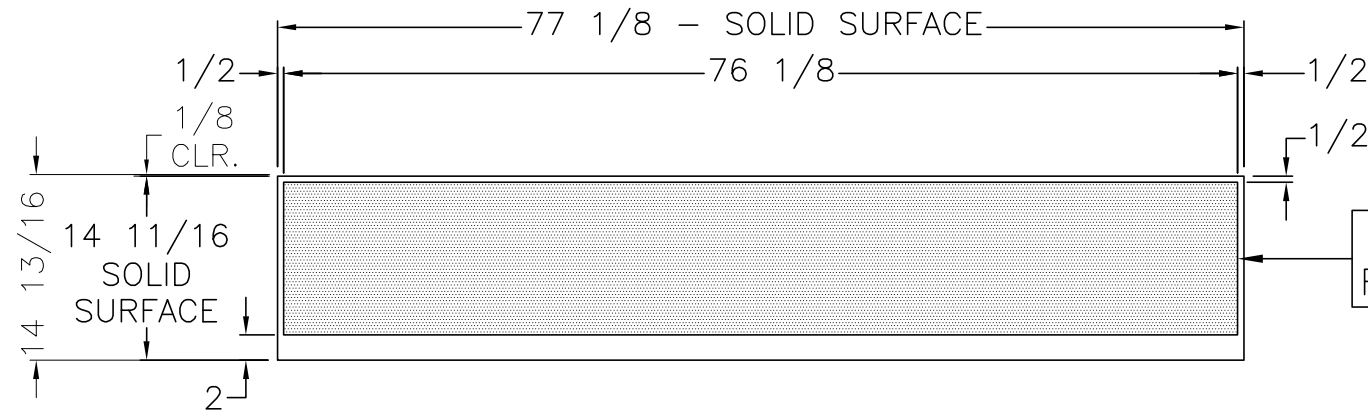

SHADED DENOTES 1/4" RECESS FOR TILE INLAY

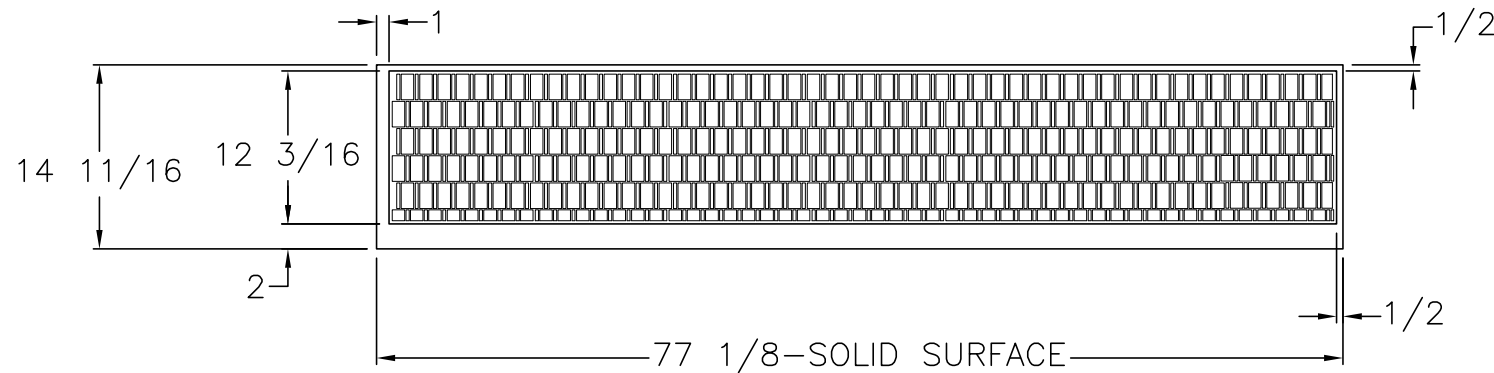

UNIT: # 501279
DEALER: Desert Autoplex
SPECIAL: # 423

SPLASH

NEWMAR CORP P.O. Box 30, Nappanee, IN. 46550 Title block--75TB	Model: LA DP 4565	Sheet 1 OF 1	Drawn by: Z. R.	Checked by: A. M.	Revision:	By:
	Title: 81 5/8 KITCHEN	I.D. # 2016\ SPECIALS\MOT\ 423KT	Date: 9/11/15	Date: 9/14/15	Revision:	By:

2016 MA DP TILE

PLEASE ACKNOWLEDGE AND DATE THE FOLLOWING ORDER/PRINT FOR APPROVAL TO BUILD, AND FAX TO NEWMAR (AT 574-773-2895) AS SOON AS POSSIBLE

DATE: _____
SIGN: _____

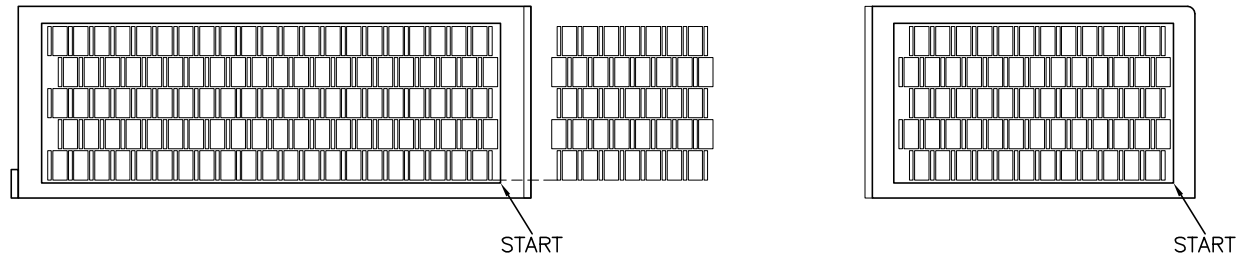
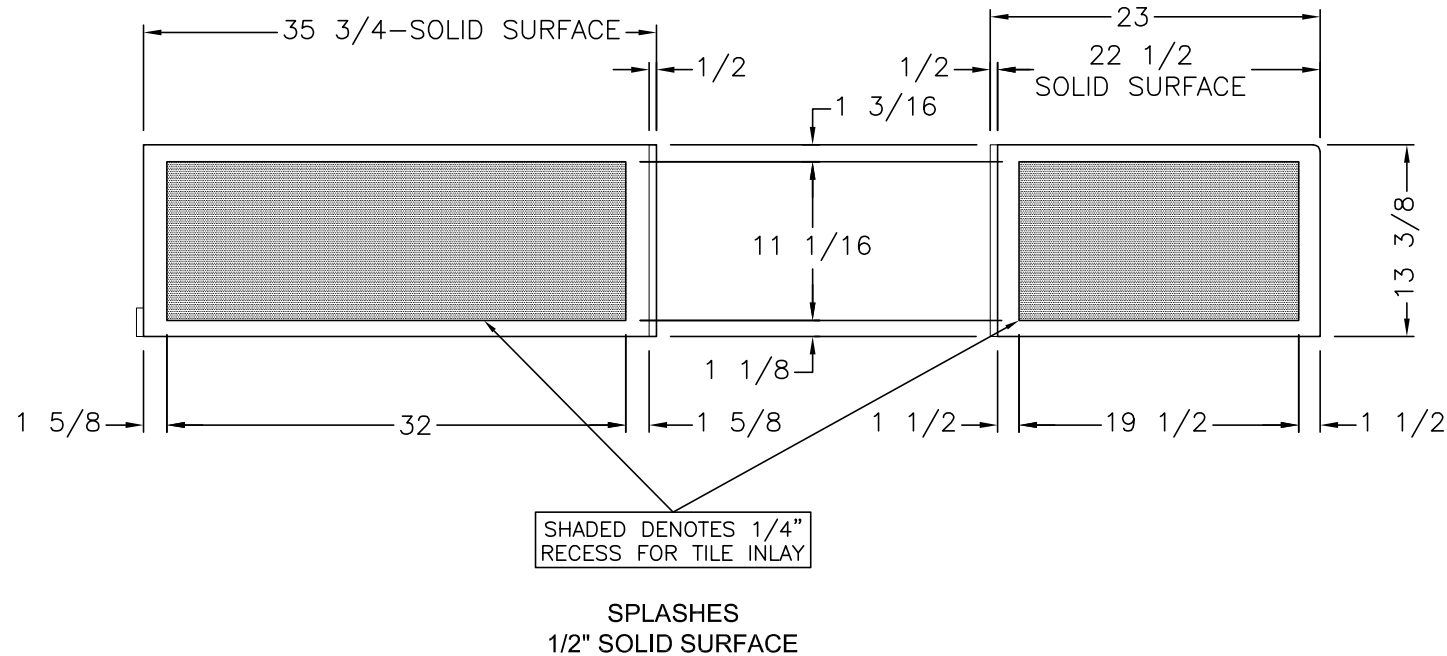

UNIT: # 501279
DEALER: Desert Autoplex
SPECIAL: # 423

NEWMAR CORP P.O. Box 30, Nappanee, IN. 46550	Model:	Sheet	Drawn by:	Checked by:	Revision:	By:
	LA DP 4565	1 OF 1	Z. R.	A. M.		Date:
Title:	I.D. # 2016\	Date:	Date:	Revision:	By:	Date:
Title block--1TB	LAV BASE & TOP	SPECIALS\MOT\	9/11/15	9/14/15		Date:
		423LV				

2016 MA DP TILE

PLEASE ACKNOWLEDGE AND DATE THE FOLLOWING ORDER/PRINT FOR APPROVAL TO BUILD, AND FAX TO NEWMAR (AT 574-773-2895) AS SOON AS POSSIBLE

DATE: _____
SIGN: _____

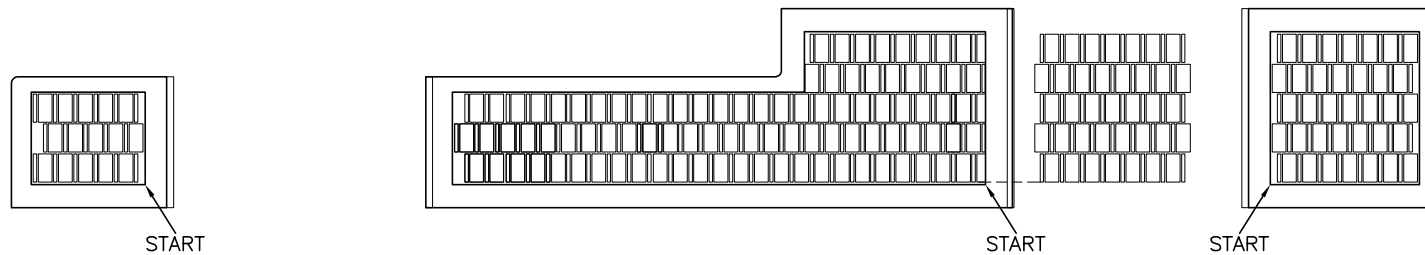
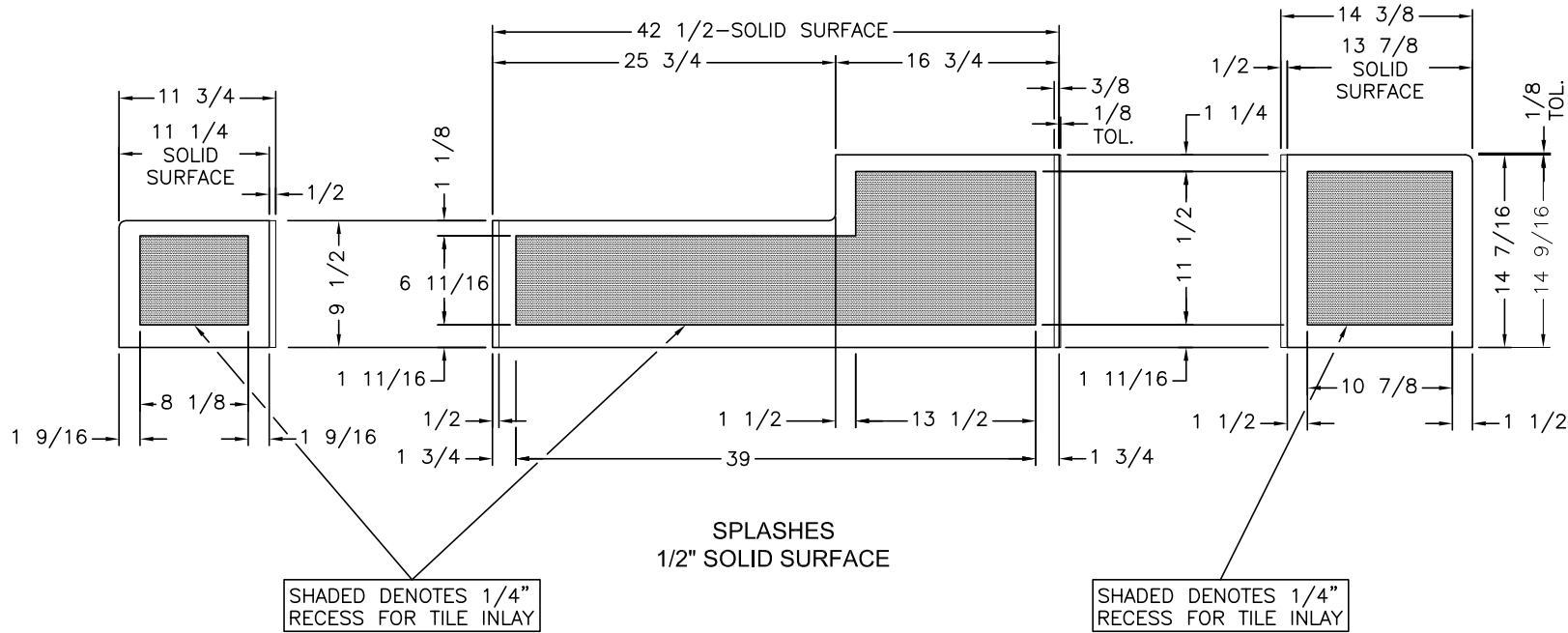

UNIT: # 501279
DEALER: Desert Autoplex
SPECIAL: # 423

NEWMAR CORP P.O. Box 30, Nappanee, IN. 46550 Title block--1TB	Model:	Sheet	Drawn by:	Checked by:	Revision:	By:
	LA DP 4565	1 OF 1	Z. R.	A. M.		Date:
	Title:	I.D. #	Date:	Date:	Revision:	By:
	STOOL ROOM LAV BASE & TOP	2016\ SPECIALS\MOT\ 423LV1	9/11/15	9/14/15		Date:

MA DP SHOWER WALLS

PLEASE ACKNOWLEDGE AND DATE THE FOLLOWING ORDER/PRINT FOR APPROVAL TO BUILD, AND FAX TO NEWMAR (AT 574-773-2895) AS SOON AS POSSIBLE
 DATE: _____
 SIGN: _____

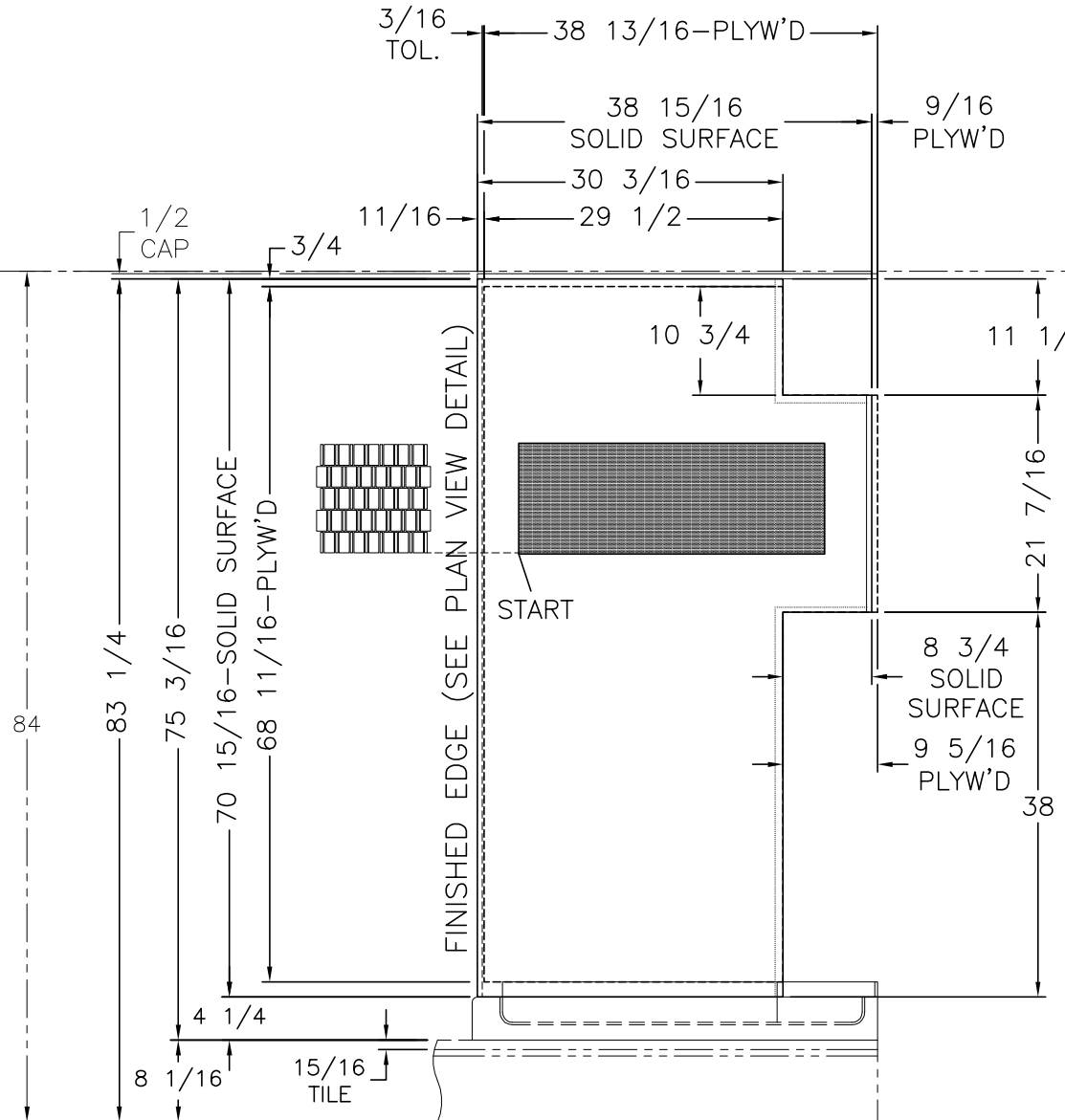

VIEW (A)

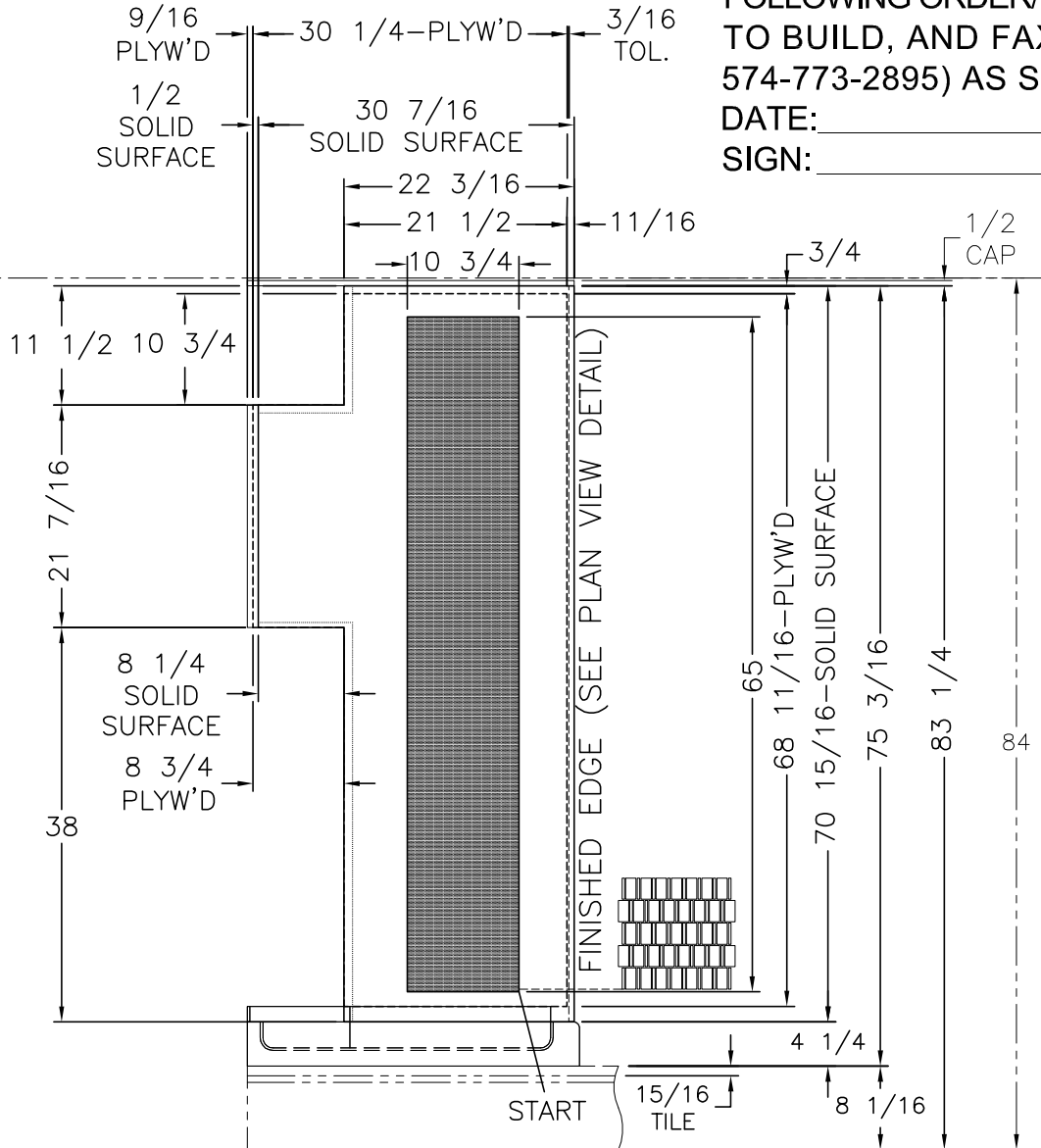

VIEW (B)

SHADED DENOTES
 1/4" DEEP RECESS

UNIT: # 501279
 DEALER: Desert Autoplex
 SPECIAL: # 423

NEWMAR CORP P.O. Box 30, Nappanee, IN. 46550 Title block--75TB	Model: LA DP 4565	Sheet 1 OF 1	Drawn by: Z. R.	Checked by: A. M.	Revision:	By:
	Title: SOLID SURFACE SHOWER WALLS	I.D. # 2016\ SPECIALS\MOT\ 423SHWR	Date: 9/14/15	Date: 9/14/15	Revision:	Date:

*ALL DIMENSION FROM POINT A

USE PART #84422
TO TRIM AROUND TILE
ON FLOOR AND
ENGINE COVER TILE
1/16" FINISHED GAP TYP.

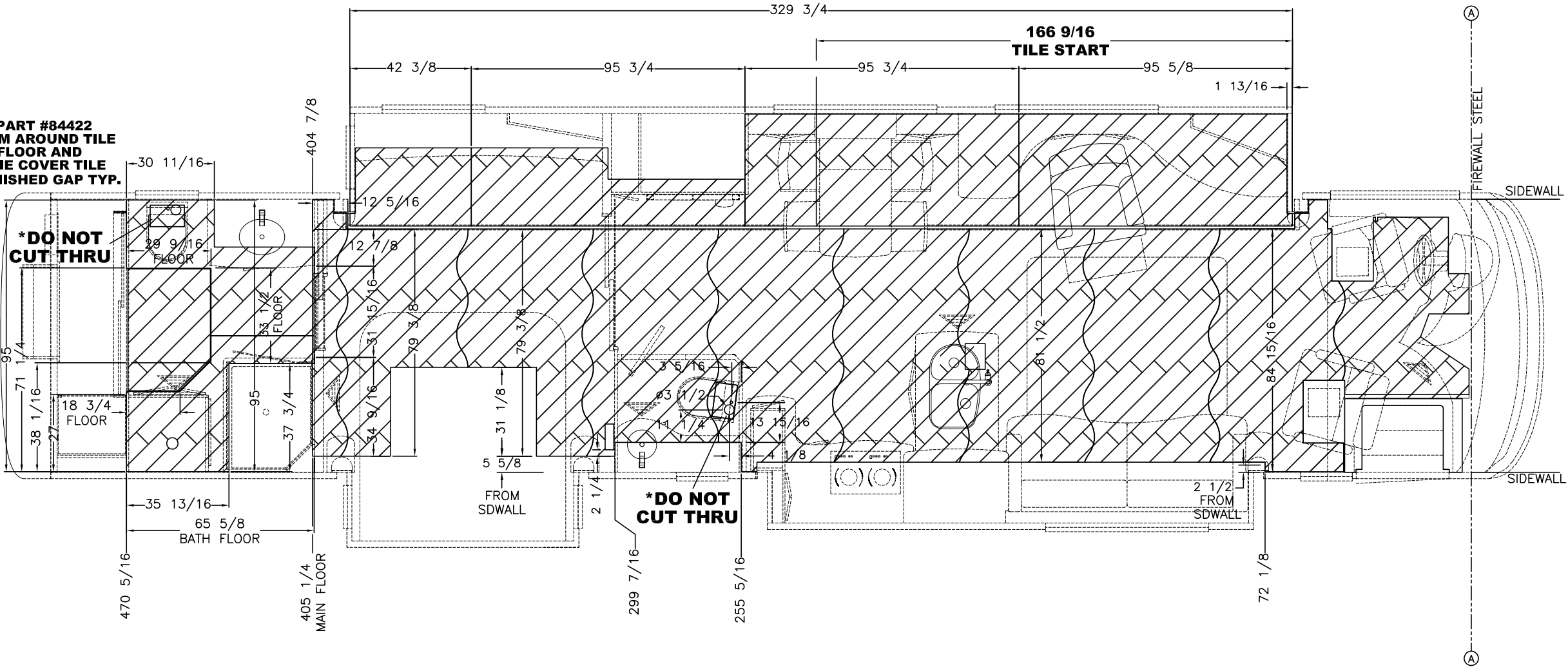

NOTE: ALL PANELS AT 47 3/4 WIDE
UNLESS SPECIFIED OTHERWISE

2016 EX DP TILE
35 1/4 x 5 13/16

PLEASE ACKNOWLEDGE AND DATE THE
FOLLOWING ORDER/PRINT FOR APPROVAL
TO BUILD, AND FAX TO NEWMAR (AT
574-773-2895) AS SOON AS POSSIBLE
DATE: _____
SIGN: _____

UNIT: # 501279
DEALER: Desert Autoplex
SPECIAL: # 423

NEWMAR CORP P.O. Box 30, Nappanee, IN. 46550 Title block--3125TB	Model: LA DP 4565	Sheet 1 OF 1	Drawn by: Z. R.	Checked by: A. M.	Revision:	By:
	Title: FLOOR PLAN	I.D. # 2016\ SPECIALS\MOT\ 423TILE	Date: 9/11/15	Date: 9/14/15	Revision:	Date: