

PLEASE ACKNOWLEDGE AND DATE THE FOLLOWING ORDER/PRINT FOR APPROVAL TO BUILD, AND FAX TO NEWMAR (AT 574-773-2895) AS SOON AS POSSIBLE  
 DATE: \_\_\_\_\_  
 SIGN: \_\_\_\_\_

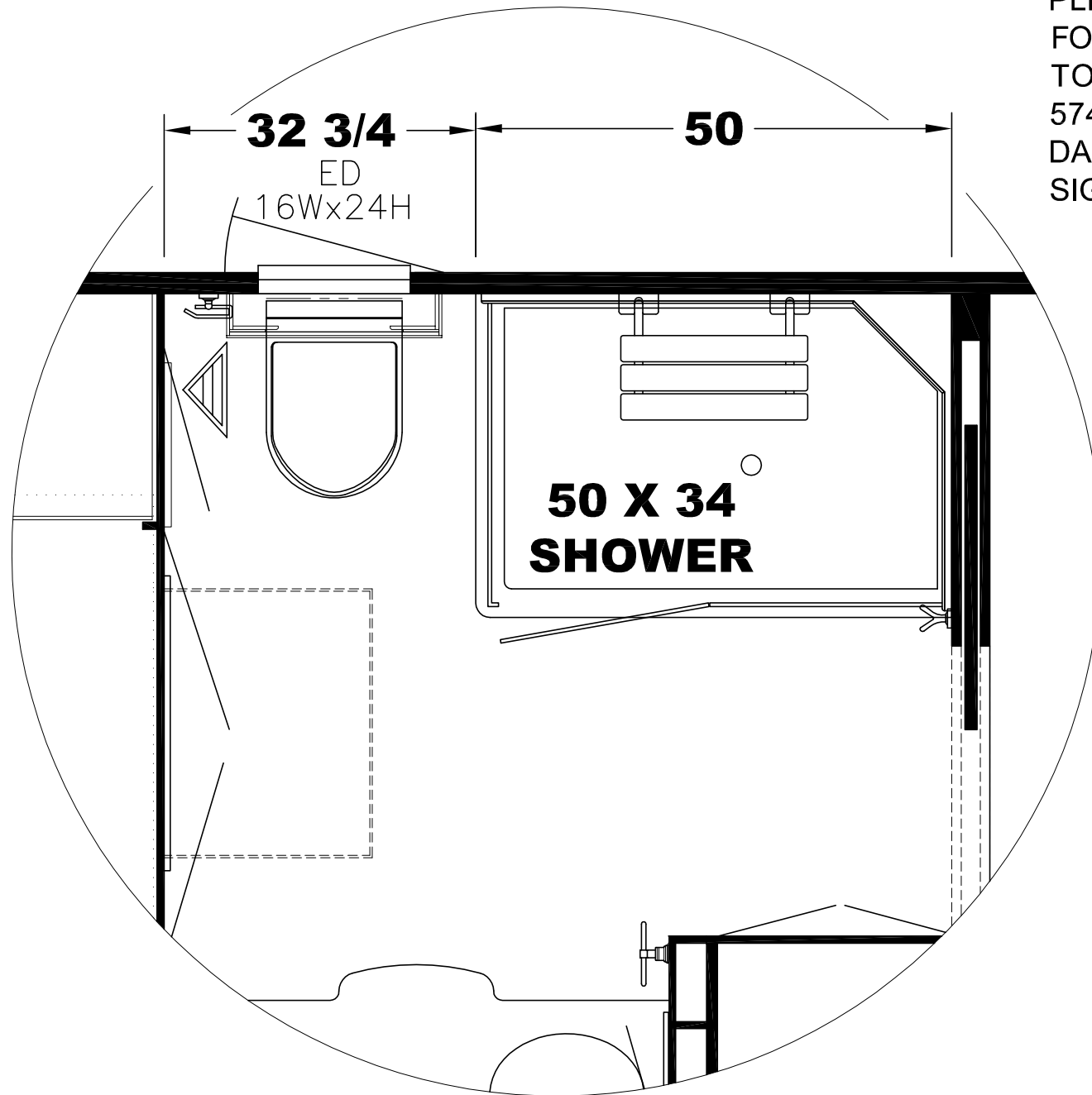

UNIT: # 606326  
 DEALER: Albany RV  
 SPECIAL: # 1043

**NEWMAR CORP**  
 P.O. Box 30,  
 Nappanee, IN. 46550

Model: DS DP 4369	Sheet 1 OF 1	Drawn by: Z. R.	Checked by: A. M.	Revision:	By:
	Title: FLOOR PLAN	I.D. # 2017 SPECIALS\MOT\ 1043FP	Date: 10/5/16	Date: 10/12/16	Date:
Title block--1TB					By:
					Date:

ITEM #	QTY	NEWMAR #	DESCRIPTION
1	1	133838	SHOWER CONTROL MOUNT
2	2	134630	NYLON WASHER
3	1	<b>129123</b>	<b>50 x 34 2 SIDED SHOWER BASE</b>

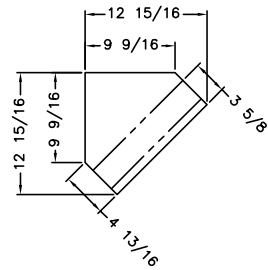
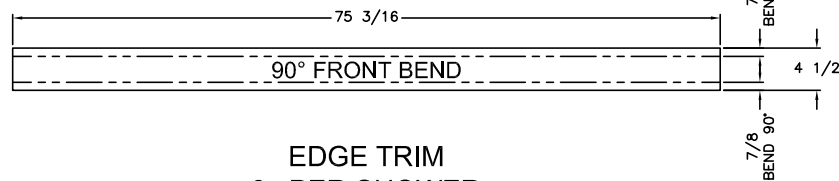
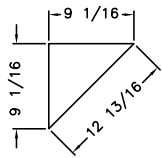
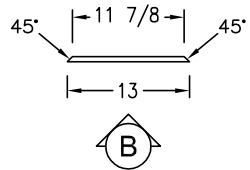

BACKER BOARD

PLYWOOD TOP  
BACKER

EDGE TRIM  
3x PER SHOWER

SHOWER TOP  
CORNER

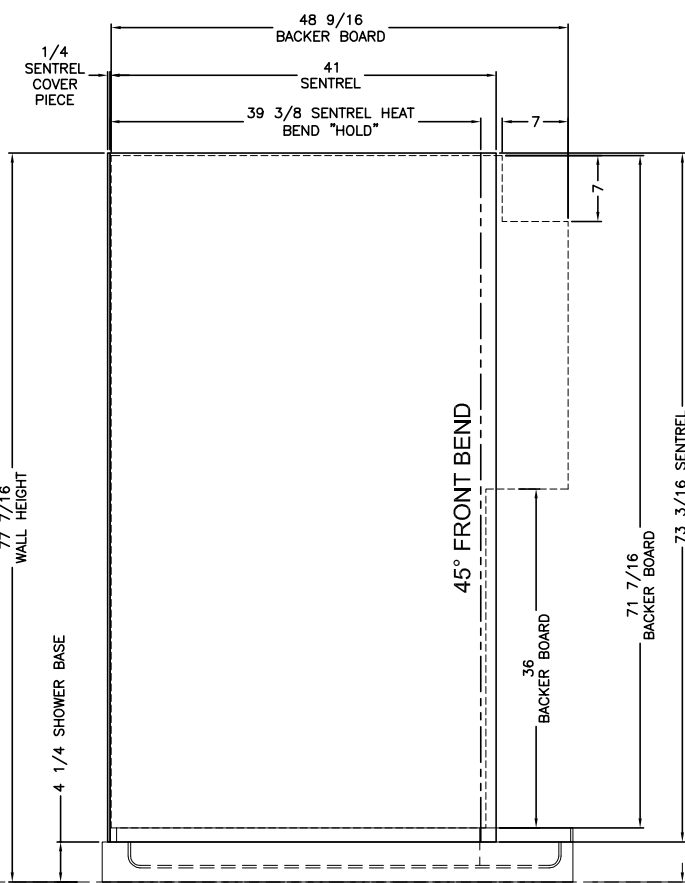
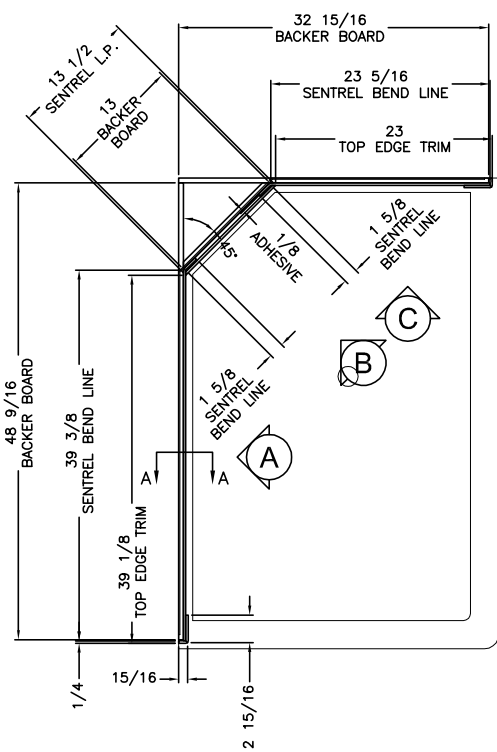

VIEW (A)

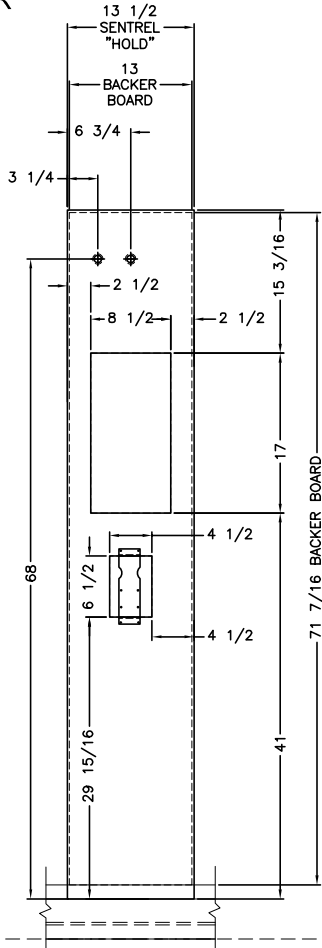

VIEW (B)

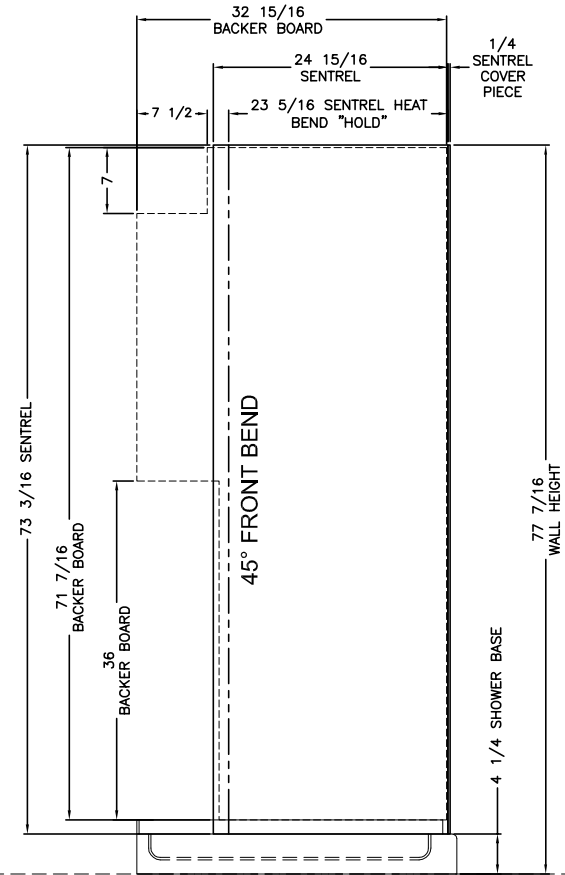

VIEW (C)

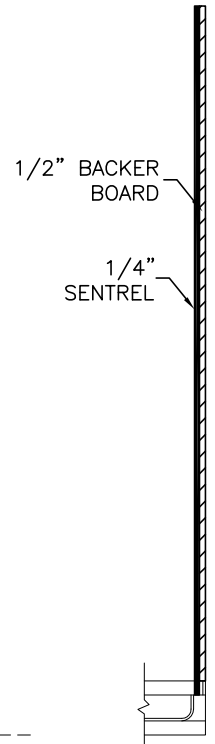

SECTION A-A

UNIT: # 606326  
DEALER: Albany RV  
SPECIAL: # 1043

RAISED REAR BATH FLOOR SHOWER

RIGHT HAND

<b>NEWMAR CORP</b> P.O. Box 30, Nappanee, IN. 46550 UNITS: INCHES TITLE BLOCK: 75TB	Model: DS DP 4369	Sheet: 1 OF 3	Drawn by: Z. R.	Checked by: A. M.	Revision:	By:
	Title: 50X34 SHORT SENTREL SHOWER WALLS	I.D. # 2017 \SPECIALS\MOT\1043SHWR	Date: 10/5/16	Date: 10/12/16	Revision:	Date:

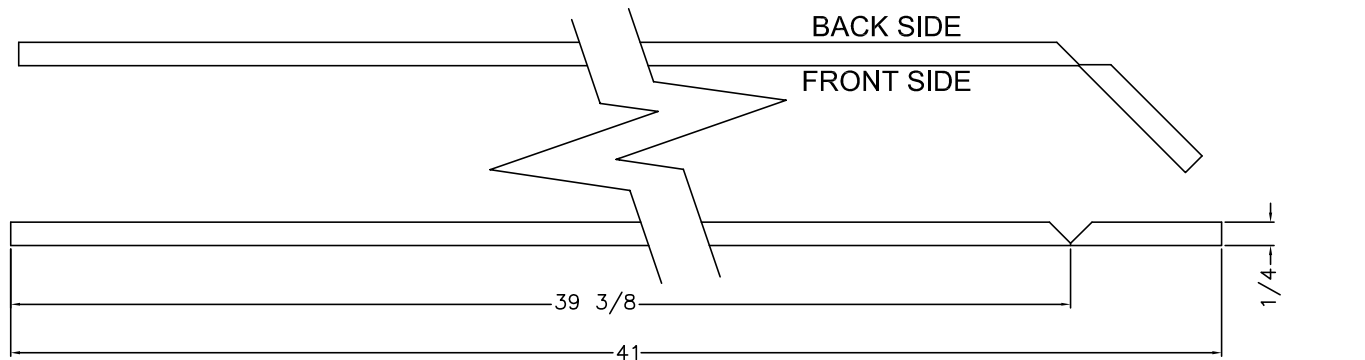
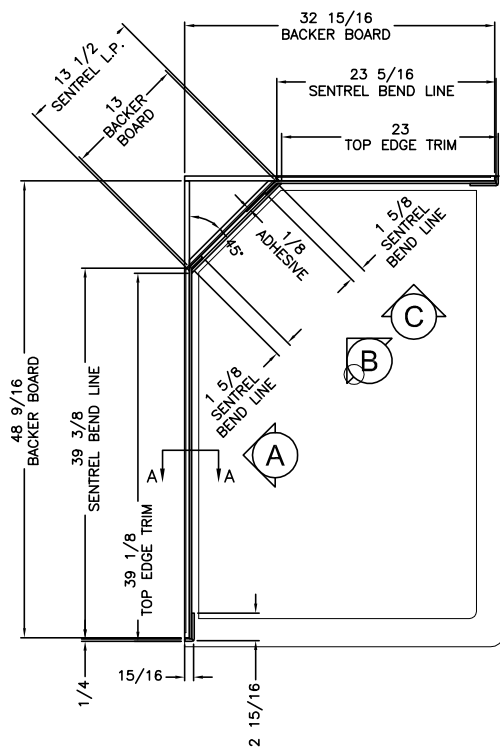

VIEW (A)

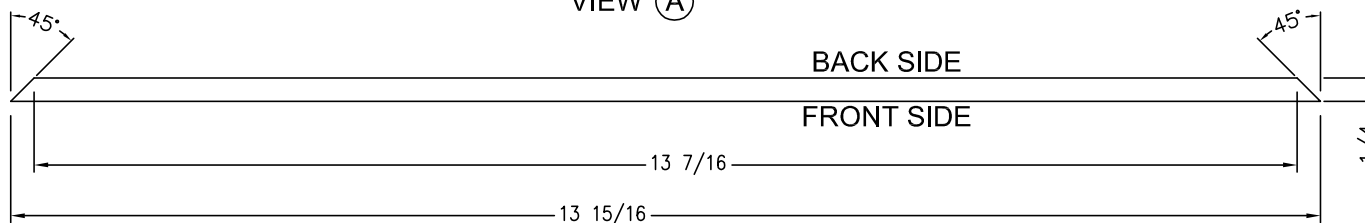

VIEW (B)

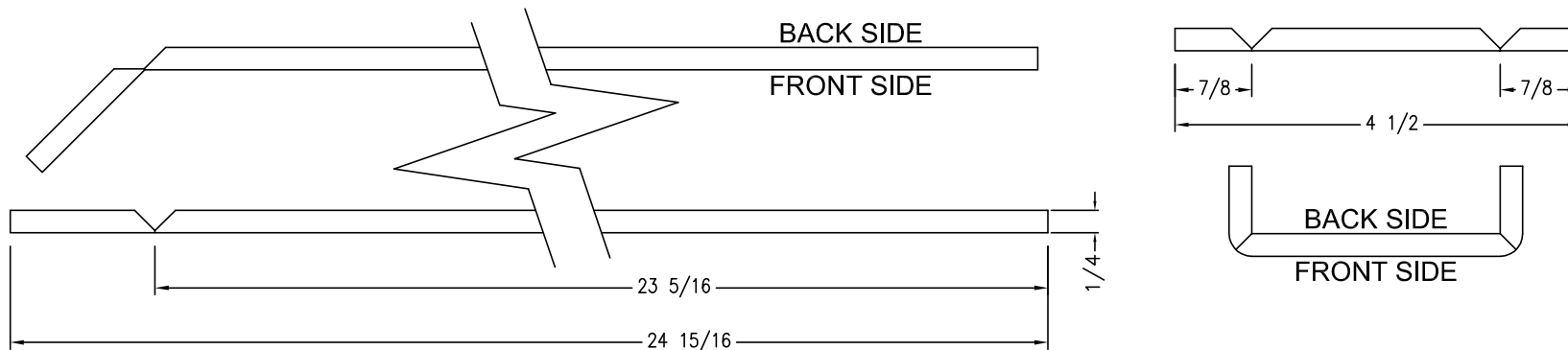

VIEW (C)

UNIT: # 606326  
 DEALER: Albany RV  
 SPECIAL: # 1043

RAISED REAR BATH FLOOR SHOWER

RIGHT HAND - SCORE DETAIL

<b>NEWMAR CORP</b> P.O. Box 30, Nappanee, IN. 46550 UNITS: INCHES TITLE BLOCK: 75TB	Model: DS DP 4369	Sheet: 2 OF 3	Drawn by: Z. R.	Checked by: A. M.	Revision:	By:
	Title: 50X34 SHORT SENTREL SHOWER WALLS	I.D. # 2017\ SPECIALS\MOT\ 1043SHWR	Date: 10/5/16	Date: 10/12/16	Revision:	Date:

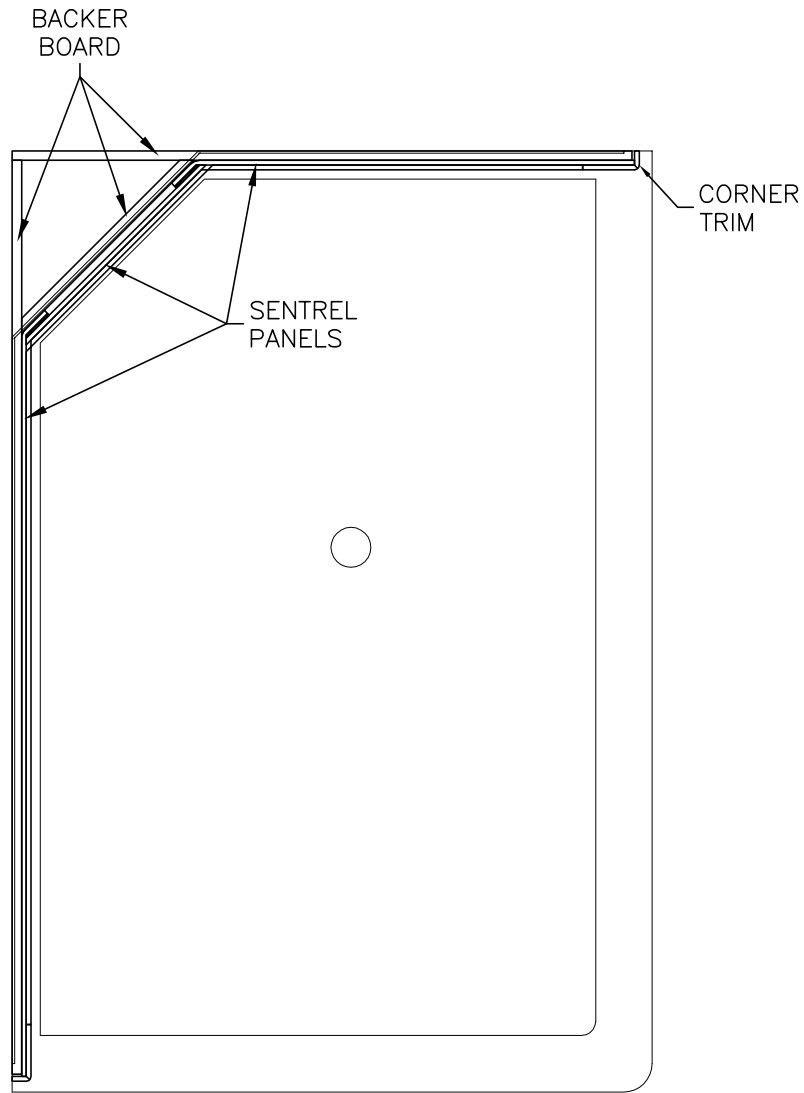

**PLAN VIEW**

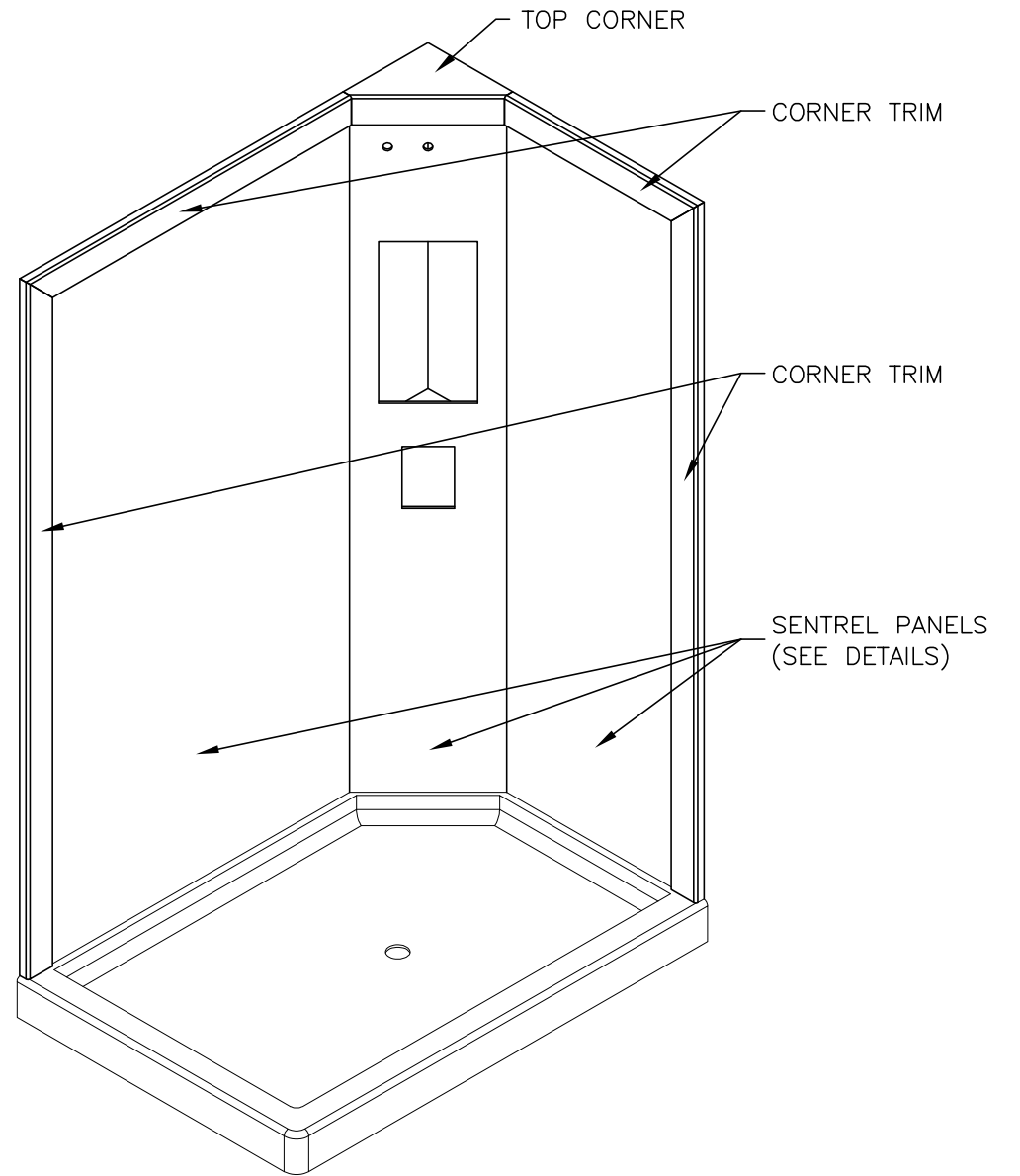

**RIGHT HAND - ISO**

UNIT: # 606326  
 DEALER: Albany RV  
 SPECIAL: # 1043

**RAISED REAR BATH FLOOR SHOWER**

<b>NEWMAR CORP</b> P.O. Box 30, Nappanee, IN. 46550 UNITS: INCHES TITLE BLOCK: 75TB	Model: DS DP 4369	Sheet 3 OF 3	Drawn by: Z. R.	Checked by: A. M.	Revision:	By:
	Title: 50X34 SHORT SENTREL SHOWER WALLS	I.D. # 2017 \ SPECIALS \ MOT \ 1043SHWR	Date: 10/5/16	Date: 10/12/16	Revision:	Date:
						By:
						Date:

NOTE: ALL DIMENSIONS POINT TO TILE GEOMETRY EXCEPT WHERE NOTED

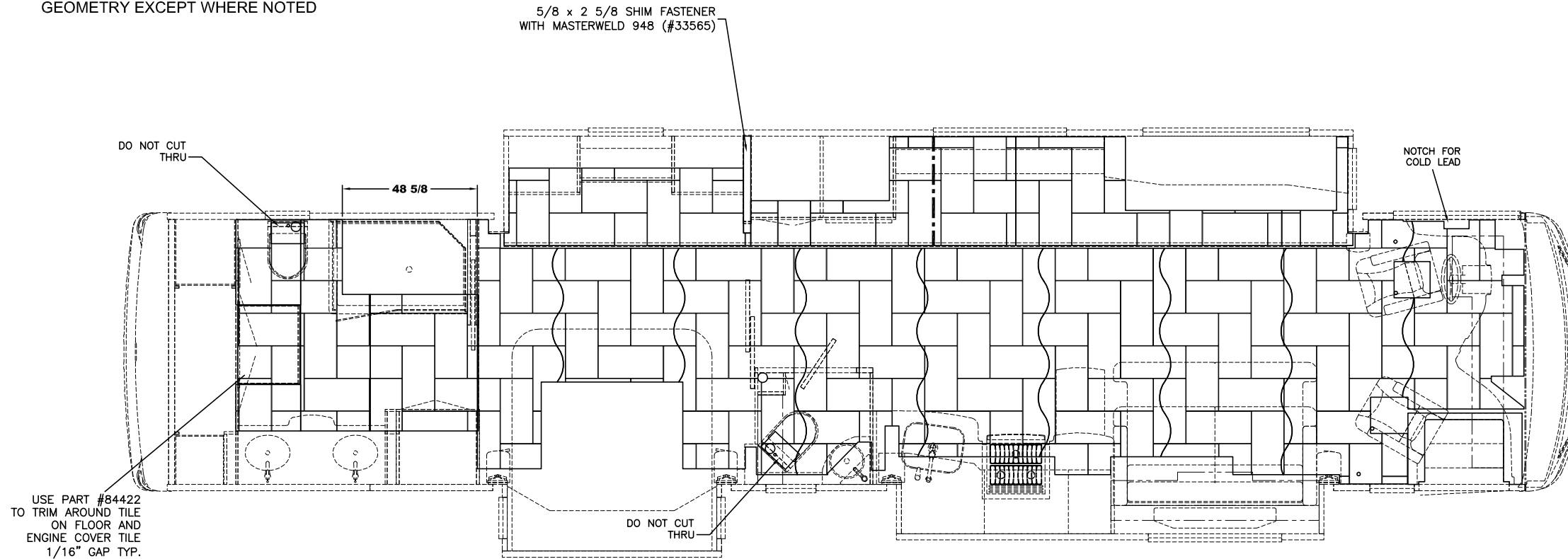

**2017 LA DP TILE**  
**11 9/16 x 23 3/8**

PLEASE ACKNOWLEDGE AND DATE THE FOLLOWING ORDER/PRINT FOR APPROVAL TO BUILD, AND FAX TO NEWMAR (AT 574-773-2895) AS SOON AS POSSIBLE  
DATE: \_\_\_\_\_  
SIGN: \_\_\_\_\_

UNIT: # 606326  
DEALER: Albany RV  
SPECIAL: # 1043

<b>NEWMAR CORP</b> P.O. Box 30, Nappanee, IN. 46550	Model:	Sheet	Drawn by:	Checked by:	Revision:	By:
	DS DP 4369	1 OF 1	Z. R.	A. M.		Date:
UNITS: INCHES	Title:	I.D. # 2017\	Date:	Date:	Revision:	By:
TITLE BLOCK: 3125TB	STANDARD TILE LAYOUT	SPECIALS\MOT\ 1043TILE	10/5/16	10/12/16		Date: